

**VICTOR REINZ®**

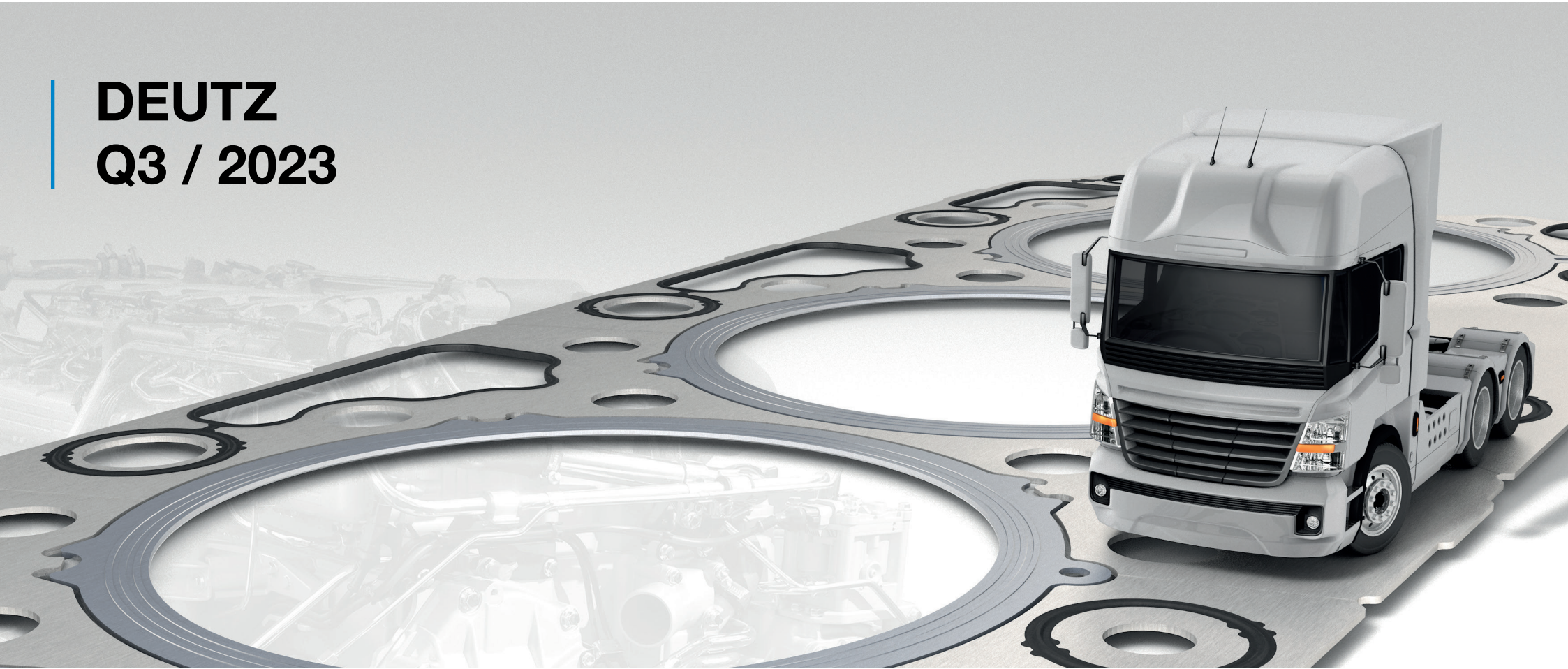

**DEUTZ**  
**Q3 / 2023**



**[VictorReinz.com/online-catalog](https://VictorReinz.com/online-catalog)**

# Victor Reinz®

at a Glance



## Online Catalog

[VictorReinz.com/online-catalog](https://VictorReinz.com/online-catalog)



## Newsletter

[VictorReinz.com/EN/News/Newsletter.aspx?region](https://VictorReinz.com/EN/News/Newsletter.aspx?region)



## Youtube

[www.youtube.com/user/VictorReinzSealingEN](https://www.youtube.com/user/VictorReinzSealingEN)



## Catalog News

[VictorReinz.com/news](https://VictorReinz.com/news)



## Technical Service Information

[VictorReinz.com/tsi](https://VictorReinz.com/tsi)



## Facebook

[www.facebook.com/VictorReinzParts](https://www.facebook.com/VictorReinzParts)



## Just seal it!

[VictorReinz.com/jsi](https://VictorReinz.com/jsi)



## Technical Datasheet

[VictorReinz.com/jsi-datasheet](https://VictorReinz.com/jsi-datasheet)



## LinkedIn

[www.linkedin.com/showcase/victor-reinz-emea](https://www.linkedin.com/showcase/victor-reinz-emea)



## Safety Datasheet

[VictorReinz.com/jsi-datasheet](https://VictorReinz.com/jsi-datasheet)



## Homepage

[VictorReinz.com](https://VictorReinz.com)



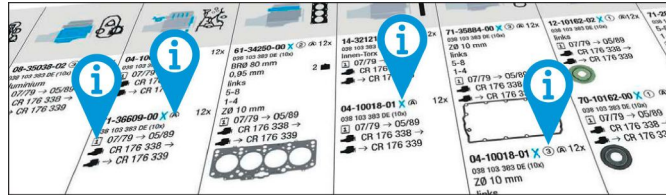

[VictorReinz.com/catalog-info](https://www.victorreinz.com/catalog-info)

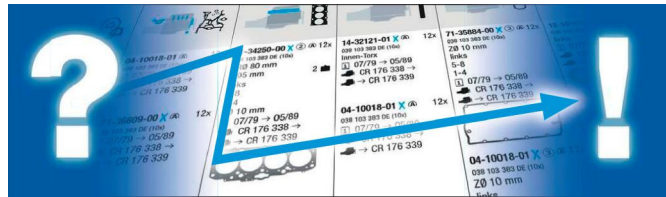

[VictorReinz.com/catalog-how-to-use](https://www.victorreinz.com/catalog-how-to-use)

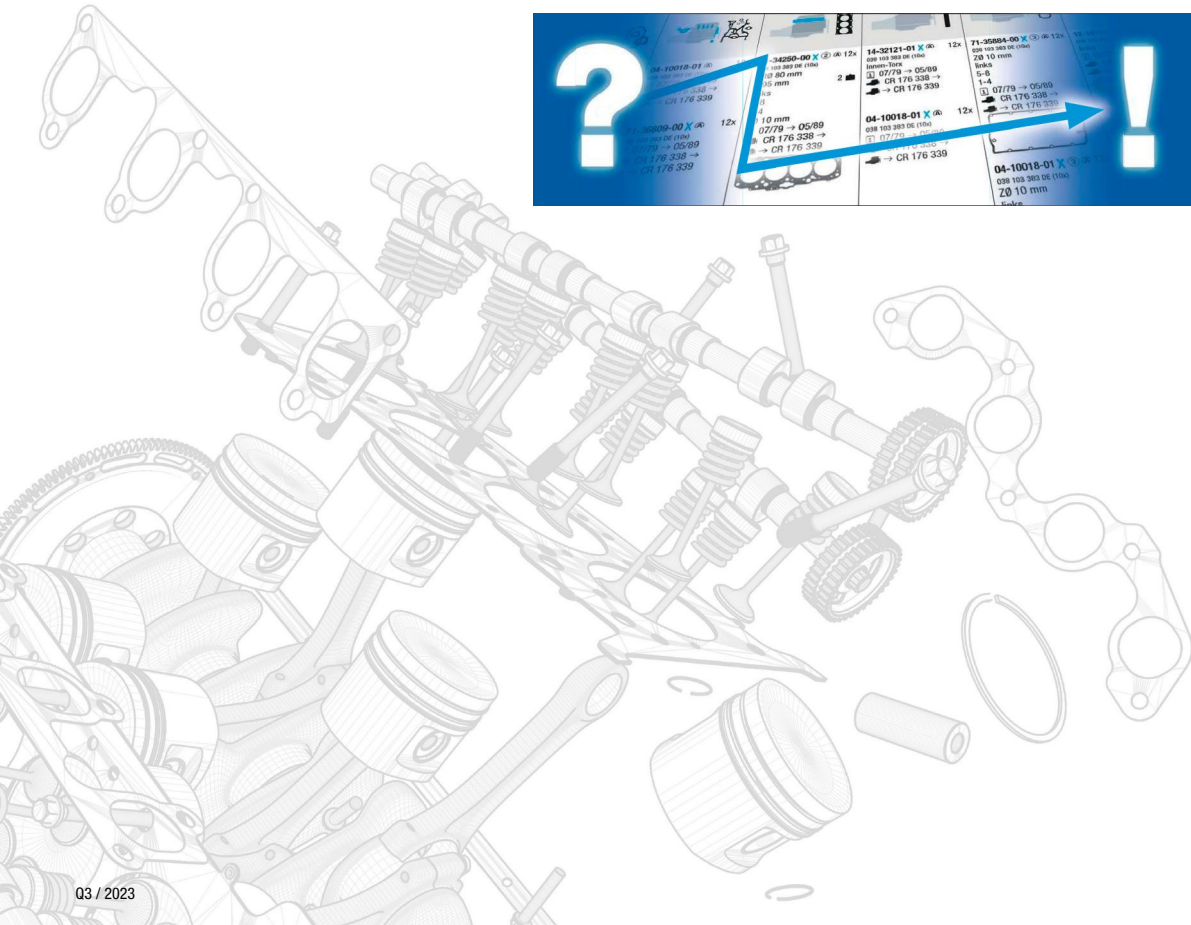

# DEUTZ



<b>0-9</b>	
8220.02.842	51
8360.05.670	51

**B**

BA 12M 816	20
BF 10 L 413 F	10
BF 10L 513	17
BF 12 L 413	12
BF 12 L 413 F	12
BF 12 L 413 FW	12
BF 12 L 714	19
BF 12L 413	12
BF 12L 413 F	12
BF 12L 513	12
BF 12L 513 C	12
BF 12L 513 F	12
BF 16 M 716	20
BF 3L 1011 FL	37
BF 3L 2011	42
BF 3L 914	31
BF 3M 1011 F	37
BF 3M 2011	42
BF 4 L 1011	37
BF 4 L 1011 F	38
BF 4 L 913	28
BF 4 L 913 T	28
BF 4L 1011 F	38
BF 4L 1011 FT	38
BF 4L 1012 E	39
BF 4L 1012 EC	39
BF 4L 2011	43
BF 4L 913	28
BF 4L 913 T	28
BF 4L 914	32
BF 4M 1011 F	38
BF 4M 1012	39
BF 4M 1012 C	39
BF 4M 1012 E	39
BF 4M 1012 EC	39
BF 4M 1013	39
BF 4M 1013 C	39
BF 4M 1013 E	39
BF 4M 1013 ECW	39



<b>Code</b>	
BF 4M 1013 EW	39
BF 4M 1013 FC	39
BF 4M 1013E C	39
BF 4M 2011	43
BF 4M 2012	45
BF 4M 2012 C	45
BF 4M 2012 C*	45
BF 4M 2013	47
BF 4M 2013 C	48
BF 6 L 912	25
BF 6 L 913	30
BF 6 L 913 T	30
BF 6L 1012 E	39
BF 6L 1012 EC	39
BF 6L 912	25
BF 6L 913	30
BF 6L 913 C	30
BF 6L 913 T	30
BF 6L 914	34
BF 6L 914 C	34
BF 6M 1012	39
BF 6M 1012 C	39
BF 6M 1012 E	39
BF 6M 1012 EC	39
BF 6M 1013	40
BF 6M 1013 C	40
BF 6M 1013 CP	40
BF 6M 1013 E	40
BF 6M 1013 EC	40
BF 6M 1013 ECW	40
BF 6M 1013 EW	40
BF 6M 1013 FC	40
BF 6M 1013E CP	40
BF 6M 1015	40
BF 6M 1015 C	40
BF 6M 1015 CP	40
BF 6M 2012 C	46
BF 6M 2012 C*	46
BF 6M 2013	48
BF 6M 2013 C	48
BF 8 L 413 F	8
BF 8 L 513 LC	15
BF 8 L 513-225	15
BF 8 L 513-243	15
BF 8 M 716	20



<b>Code</b>	
BF 8L 413 F	8
BF 8L 513	16
BF 8M 1015	41
BF 8M 1015 C	41
BF 8M 1015 CP	41
<b>D</b>	
D 2.2 L3	51
D 2.9 L4	51
D 2009 L3	41
D 2009 L4	41
D 2011 L2	43
D 2011 L2 I	43
D 2011 L3	44
D 2011 L3 I	44
D 2011 L4 I	44
D 2011 L4 W	44
D 914 L3	32
D 914 L4	33
D 914 L5	34
D 914 L6	35
<b>F</b>	
F 1 L 514	17
F 10 L 413	11
F 10 L 413 F	11
F 10 L 413 L	11
F 10 L 714	19
F 10L 413	11
F 10L 413 F	11
F 10L 413 FW	11
F 10L 413 L	11
F 10L 513	17
F 12 L 413	13
F 12 L 413 F	13
F 12 L 513	12
F 12L 413	13
F 12L 413 F	13
F 12L 513	12
F 12L 513 F	12
F 1L 511	14
F 1L 511 D	14
F 1L 514	17
F 1L 712	18









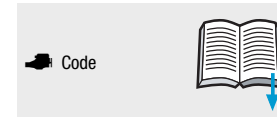

<b>Code</b>	
F 1L 812	18
F 2L 1011	52
F 2L 1011 F	36
F 2L 2011	43
F 2L 511	15
F 2L 511 D	15
F 2L 514	18
F 2L 712	18
F 2L 812	18
F 2L 912	21
F 2M 1011	36
F 2M 2011	43
F 3L 1011	52
F 3L 1011 F	37
F 3L 2011	44
F 3L 514	18
F 3L 712	18
F 3L 812	18
F 3L 912	22
F 3L 913	22
F 3L 914	32
F 3M 1011 F	37
F 3M 2011	44
F 4 L 1011	38
F 4 L 912	23
F 4 L 913	29
F 4L 1011 F	38
F 4L 1011 FL	38
F 4L 2011	43
F 4L 413 F	5
F 4L 413 FR	5
F 4L 712	18
F 4L 812	18
F 4L 912	23
F 4L 913	29
F 4L 914	33
F 4M 1011 F	38
F 4M 2011	43
F 5L 413 FR	5
F 5L 413 R	5
F 5L 912	24
F 5L 912 D	24
F 5L 914	34
F 6 L 413	6
F 6 L 413 F	7



<b>Code</b>	
F 6 L 413 V	8
F 6 L 712	19
F 6 L 714	19
F 6 L 812	19
F 6 L 812 D	19
F 6 L 912	27
F 6 L 913	31
F 6L 413	6
F 6L 413 F	6
F 6L 413 FR	7
F 6L 413 FW	7
F 6L 413 R	8
F 6L 712	19
F 6L 912	26
F 6L 913	31
F 6L 914	35
F 8 L 413	9
F 8 L 413 F	9
F 8 L 413 W	9
F 8 L 513	16
F 8 L 714	19
F 8 L 914	36
F 8 M 716	20
F 8L 413	9
F 8L 413 F	9
F 8L 413 FW	9
F 8L 513	16
<b>T</b>	
TCD 12.0-V6	54
TCD 16.0-V6	55
TCD 2.2 L3	51
TCD 2.9 L4	52
TCD 2.9 L4 HP	52
TCD 2.9 L4 HT	52
TCD 2011 L4	45
TCD 2011 L4 W	45
TCD 2012 L06 4V DCR	55
TCD 2012 L4 2V	46
TCD 2012 L4 4V	55
TCD 2012 L6 2V	47
TCD 2013 L06 4V	56
TCD 2013 L4 2V	49
TCD 2013 L4 4V	49
TCD 2013 L6 2V	49





















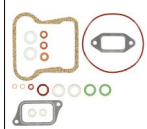









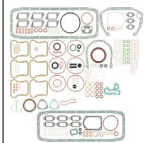
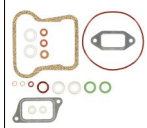















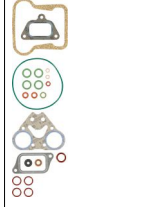

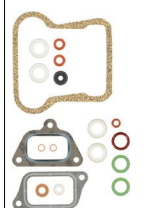

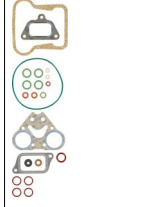



<b>Code</b>	
TCD 2013 L6 4V	50
TCD 2015 V6	50
TCD 2015 V8	50
TCD 3.6 L04 Tier 4i	53
TCD 3.6 L4	53
TCD 3.6 L4 HP	53
TCD 3.6 L4 HT	53
TCD 4.1 L04 4V	53
TCD 6.1 L06 4V	53
TCD 7.8 L6	54
TCD 914 L6	36
TCG 2015 V6	56
TCG 2015 V8	56
TD 2.2 L3	51
TD 2.9 L4	51
TD 2009 L4	41
TD 2011 L4 I	45
TD 2011 L4 W	45
TD 3.6 L4	53
TTCD 7.8 L6	57













<p><b>DEUTZ</b></p>											
<p>F 4L 413 FR F 4L 413 F</p> <p>4 Cyl.</p> <p>Ltr.</p>		<p><b>03-12917-07</b>  4x 0291 1536</p>  <p><b>03-13037-03</b>  4x 0291 1550</p> 					<p><b>71-12917-00</b>  4x 0424 2812</p>  <p><b>71-13037-00</b>  4x 0424 1047</p> 		<p><b>71-25556-00</b>  4x 0414 1486</p>  <p><b>71-23727-50</b>  4x 0418 4903</p> 		
<p>F 5L 413 FR</p> <p>5 Cyl.</p>		<p><b>03-13037-03</b> 0291 1550</p> 					<p><b>71-13037-00</b> 5x 0424 1047</p> 		<p><b>71-25556-00</b>  5x 0414 1486</p>  <p><b>71-23727-50</b>  5x 0418 4903</p> 		<p><b>81-26022-00</b>  K↔ 0414 2503 95x130 A SL RD FPM</p>  <p><b>81-26023-00</b>  K↔ 0242 7225 135x160 A SL LD FPM</p> 
<p>F 5L 413 R</p> <p>5 Cyl.</p>		<p><b>03-12917-06</b> 0291 1516</p> 					<p><b>71-12917-00</b> 5x 0424 2812</p> 		<p><b>71-25556-00</b>  5x 0414 1486</p>  <p><b>71-20656-30</b>  5x 0336 2170</p> 		<p><b>81-26022-00</b>  K↔ 0414 2503 95x130 A SL RD FPM</p>  <p><b>81-26023-00</b>  K↔ 0242 7225 135x160 A SL LD FPM</p> 

DEUTZ											
<p>F 6 L 413</p> <p>6 Cyl. Ltr.</p>	<p><b>01-12917-39</b> 0291 1525</p> <p><b>01-12917-43</b> 0291 1525</p>	<p><b>03-12917-06</b> 0291 1516</p>					<p><b>71-12917-00</b>  6x 0240 2812</p>		<p><b>71-25556-00</b>  6x 0414 1486</p> <p><b>71-20656-30</b>  6x 0336 2170</p>	<p><b>71-22083-10</b>  20 0240 3119</p> <p><b>71-22108-10</b>  19 0213 1576</p>	<p><b>81-22593-20</b>  K  </p> <p>0241 3331 90x110 B SL RD FPM</p> <p><b>81-23301-40</b>  K </p> <p>0241 3332 105x130 AB SL LD FPM</p>
<p>F 6 L 413</p> <p>6 Cyl.</p>	<p><b>01-12917-39</b> 0291 1525</p> <p><b>01-12917-43</b> 0291 1525</p>	<p><b>03-12917-06</b> 0291 1516</p>					<p><b>71-12917-00</b>  6x 0240 2812</p>		<p><b>71-25556-00</b>  6x 0414 1486</p> <p><b>71-20656-30</b>  6x 0336 2170</p>	<p><b>71-22083-10</b>  20 0240 3119</p> <p><b>71-22108-10</b>  19 0213 1576</p>	<p><b>81-22593-20</b>  K  </p> <p>0241 3331 90x110 B SL RD FPM</p> <p><b>81-23301-40</b>  K </p> <p>0241 3332 105x130 AB SL LD FPM</p>
<p>F 6 L 413 F</p> <p>6 Cyl.</p>	<p><b>01-12974-14</b>  29 0292 8811</p>	<p><b>03-12917-07</b>  29 0291 1536</p> <p><b>03-13037-03</b>  29 0291 1550</p>					<p><b>71-12917-00</b>  6x 0240 2812</p> <p><b>71-13037-00</b>  6x 0424 1047</p>		<p><b>71-25556-00</b>  6x 0414 1486</p> <p><b>71-23727-50</b>  6x 0418 4903</p>	<p><b>71-22083-10</b>  20 0240 3119</p> <p><b>71-22108-10</b>  19 0213 1576</p>	<p><b>81-25986-20</b>  K  </p> <p>0242 1819 100x120 A SL RD FPM</p> <p><b>81-23301-40</b>  K </p> <p>0241 3332 105x130 AB SL LD FPM</p>

DEUTZ												
F 6 L 413 F	6 Cyl. Ltr.	<p><b>01-12974-14</b> </p> <p>0292 8811</p>	<p><b>03-12917-07</b> </p> <p>0291 1536</p> <p><b>03-13037-03</b> </p> <p>0291 1550</p>				<p><b>71-12917-00</b> </p> <p>0240 2812</p> <p><b>71-13037-00</b> </p> <p>0424 1047</p>		<p><b>71-25556-00</b> </p> <p>0414 1486</p> <p><b>71-23727-50</b> </p> <p>0418 4903</p>	<p><b>71-22083-10</b> </p> <p>0240 3119</p> <p><b>71-22108-10</b> </p> <p>0213 1576</p>	<p><b>81-25986-20</b> </p> <p>0242 1819 100x120 A SL RD FPM</p> <p><b>81-23301-40</b> </p> <p>0241 3332 105x130 AB SL LD FPM</p>	
F 6 L 413 FR	6 Cyl.		<p><b>03-13037-03</b> </p> <p>0291 1550</p>				<p><b>71-13037-00</b> </p> <p>0424 1047</p>		<p><b>71-25556-00</b> </p> <p>0414 1486</p> <p><b>71-23727-50</b> </p> <p>0418 4903</p>	<p><b>71-22083-10</b> </p> <p>0240 3119</p> <p><b>71-22108-10</b> </p> <p>0213 1576</p>	<p><b>81-26022-00</b> </p> <p>0414 2503 95x130 A SL RD FPM</p> <p><b>81-26023-00</b> </p> <p>0242 7225 135x160 A SL LD FPM</p>	
F 6 L 413 FW	6 Cyl.	<p><b>01-13037-07</b> </p> <p>0292 8818</p>	<p><b>03-13037-04</b> </p> <p>0291 1545</p>				<p><b>71-13037-00</b> </p> <p>0424 1047</p> <p><b>12-27506-03</b> </p> <p>0242 3697 (12x)</p> <p><b>70-27506-00</b> </p> <p>0242 3697</p>		<p><b>71-25556-00</b> </p> <p>0414 1486</p> <p><b>71-23727-50</b> </p> <p>0418 4903</p>	<p><b>71-22108-10</b> </p> <p>0213 1576</p>	<p><b>81-25986-20</b> </p> <p>0242 1819 100x120 A SL RD FPM</p> <p><b>81-23301-40</b> </p> <p>0241 3332 105x130 AB SL LD FPM</p>	

















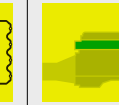
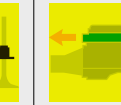
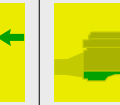

































<p><b>DEUTZ</b></p>											
<p>F 6 L 413 R      6 Cyl.      Ltr.</p>		<p><b>03-12917-06</b> 0291 1516</p> 					<p><b>71-12917-00</b>      6x 0240 2812</p> 		<p><b>71-25556-00</b>       6x 0414 1486</p>   <p><b>71-20656-30</b>      6x 0336 2170</p> 		<p><b>81-26022-00</b>       6x 0414 2503 95x130 A SL RD FPM</p>   <p><b>81-26023-00</b>       6x 0242 7225 135x160 A SL LD FPM</p> 
<p>F 6 L 413 V      6 Cyl.</p>	<p><b>01-12917-39</b> 0291 1525</p>   <p><b>01-12917-43</b> 0291 1525</p> 	<p><b>03-12917-06</b> 0291 1516</p> 					<p><b>71-12917-00</b>      6x 0240 2812</p> 	<p><b>71-25556-00</b>       6x 0414 1486</p>   <p><b>71-20656-30</b>      6x 0336 2170</p> 	<p><b>71-22083-10</b>       6x 0240 3119</p>   <p><b>71-22108-10</b>       6x 0213 1576</p> 	<p><b>81-22593-20</b>       6x 0241 3331 90x110 B SL RD FPM</p>   <p><b>81-23301-40</b>       6x 0241 3332 105x130 AB SL LD FPM</p> 	
<p>BF 8 L 413 F      8 Cyl. BF 8L 413 F</p>	<p><b>01-12917-40</b>       8x 0291 1539</p>   <p><b>03-13037-03</b>       8x 0291 1550</p> 	<p><b>03-12917-07</b>       8x 0291 1536</p>   <p><b>03-13037-03</b>       8x 0291 1550</p> 					<p><b>71-12917-00</b>       8x 0240 2812</p>   <p><b>71-13037-00</b>       8x 0424 1047</p> 	<p><b>71-25556-00</b>       8x 0414 1486</p>   <p><b>71-23727-50</b>      8x 0418 4903</p> 	<p><b>71-22105-20</b> 0213 1577</p> 	<p><b>81-25986-20</b>       8x 0242 1819 100x120 A SL RD FPM</p>   <p><b>81-23301-40</b>       8x 0241 3332 105x130 AB SL LD FPM</p> 	



















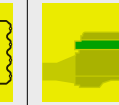
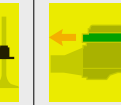
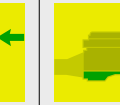

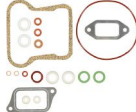













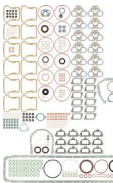

DEUTZ												
F 8 L 413 F 8L 413	8 Cyl. Ltr.	<p><b>01-12917-21</b> 0291 1526</p> 	<p><b>03-12917-06</b> 0291 1516</p> 					<p><b>71-12917-00</b> 8x 0240 2812</p> 		<p><b>71-25556-00</b> 8x 0414 1486</p>  <p><b>71-20656-30</b> 8x 0336 2170</p> 	<p><b>71-22105-20</b> 0213 1577</p> 	<p><b>81-22593-20</b> K↔ 0241 3331 90x110 B SL RD FPM</p>  <p><b>81-23301-40</b> K↔ 0241 3332 105x130 AB SL LD FPM</p> 
F 8 L 413 F F 8L 413 F	8 Cyl.	<p><b>01-12917-25</b> 23 0291 1537</p>  <p><b>01-12917-44</b> 23 0291 1537</p>  <p><b>01-13037-17</b> 23 0292 8809 +0242 1819 +0242 1820</p> 	<p><b>03-12917-07</b> 23 0291 1536</p>  <p><b>03-13037-03</b> 23 0291 1550</p> 				<p><b>71-12917-00</b> 23 8x 0240 2812</p>  <p><b>71-13037-00</b> 23 8x 0424 1047</p> 		<p><b>71-25556-00</b> 1↔ 8x 0414 1486</p>  <p><b>71-23727-50</b> 8x 0418 4903</p> 	<p><b>71-22105-20</b> 0213 1577</p> 	<p><b>81-25986-20</b> K↔ 0242 1819 100x120 A SL RD FPM</p>  <p><b>81-23301-40</b> K↔ 0241 3332 105x130 AB SL LD FPM</p> 	
F 8L 413 FW F 8L 413 W	8 Cyl.	<p><b>01-13037-08</b> 0292 8985</p> 	<p><b>03-13037-04</b> 0291 1545</p> 				<p><b>71-13037-00</b> 8x 0424 1047</p> 	<p><b>70-27506-00</b> 16x 0242 3697</p> 	<p><b>71-25556-00</b> 1↔ 8x 0414 1486</p>  <p><b>71-23727-50</b> 8x 0418 4903</p> 	<p><b>71-22105-20</b> 0213 1577</p> 	<p><b>81-25986-20</b> K↔ 0242 1819 100x120 A SL RD FPM</p>  <p><b>81-23301-40</b> K↔ 0241 3332 105x130 AB SL LD FPM</p> 	

DEUTZ											
BF 10 L 413 F      10 Cyl.      Ltr.	<p><b>01-12974-15</b> </p> <p>0291 1554</p>	<p><b>03-12917-07</b> </p> <p>0291 1536</p> <p><b>03-13037-03</b> </p> <p>0291 1550</p>					<p><b>71-12917-00</b>  10x</p> <p>0240 2812</p> <p><b>71-13037-00</b>  10x</p> <p>0424 1047</p>		<p><b>71-25556-00</b>  10x</p> <p>0414 1486</p> <p><b>71-23727-50</b>  10x</p> <p>0418 4903</p>		<p><b>81-25986-20</b> </p> <p>0242 1819 100x120 A SL RD FPM</p> <p><b>81-23301-40</b> </p> <p>0241 3332 105x130 AB SL LD FPM</p>
BF 10 L 413 F      10 Cyl.	<p><b>01-12974-15</b> </p> <p>0291 1554</p>	<p><b>03-12917-07</b> </p> <p>0291 1536</p> <p><b>03-13037-03</b> </p> <p>0291 1550</p>					<p><b>71-12917-00</b>  10x</p> <p>0240 2812</p> <p><b>71-13037-00</b>  10x</p> <p>0424 1047</p>		<p><b>71-25556-00</b>  10x</p> <p>0414 1486</p> <p><b>71-23727-50</b>  10x</p> <p>0418 4903</p>		<p><b>81-25986-20</b> </p> <p>0242 1819 100x120 A SL RD FPM</p> <p><b>81-23301-40</b> </p> <p>0241 3332 105x130 AB SL LD FPM</p>

DEUTZ												
F 10 L 413 F 10L 413 F 10L 413 L F 10L 413 L	10 Cyl. Ltr.		<p><b>03-12917-06</b> 0291 1516</p>				<p><b>71-12917-00</b> 10x 0240 2812</p>		<p><b>71-25556-00</b> 10x 0414 1486</p> <p><b>71-20656-30</b> 10x 0336 2170</p>		<p><b>81-22593-20 K↔</b> 0241 3331 90x110 B SL RD FPM</p> <p><b>81-23301-40 K↔</b> 0241 3332 105x130 AB SL LD FPM</p>	
F 10 L 413 F F 10L 413 F	10 Cyl.	<p><b>01-12974-15</b> </p> <p>0291 1554</p>	<p><b>03-12917-07</b> </p> <p>0291 1536</p> <p><b>03-13037-03</b> </p> <p>0291 1550</p>				<p><b>71-12917-00</b> </p> <p>0240 2812 10x</p> <p><b>71-13037-00</b> </p> <p>0424 1047 10x</p>		<p><b>71-25556-00</b> </p> <p>0414 1486 10x</p> <p><b>71-23727-50</b> </p> <p>0418 4903 10x</p>		<p><b>81-25986-20 K↔</b> 0242 1819 100x120 A SL RD FPM</p> <p><b>81-23301-40 K↔</b> 0241 3332 105x130 AB SL LD FPM</p>	
F 10L 413 FW	10 Cyl.	<p><b>01-13037-09</b> 0292 8986</p>	<p><b>03-13037-04</b> 0291 1545</p>				<p><b>71-13037-00</b> 10x 0424 1047</p> <p><b>70-27506-00</b> 20x 0242 3697</p>		<p><b>71-25556-00</b> </p> <p>0414 1486 10x</p> <p><b>71-23727-50</b> </p> <p>0418 4903 10x</p>		<p><b>81-25986-20 K↔</b> 0242 1819 100x120 A SL RD FPM</p> <p><b>81-23301-40 K↔</b> 0241 3332 105x130 AB SL LD FPM</p>	

DEUTZ												
BF 12 L 413 BF 12L 413 BF 12L 513 BF 12L 513 C F 12L 513 F 12 L 513 F 12L 513 F	12 Cyl. Ltr.		<p><b>03-13037-03</b> 0291 1550</p>    					<p><b>71-13037-00</b> 12x 0424 1047</p> 		<p><b>71-25556-00</b> 12x 0414 1486</p>  <p><b>71-23727-50</b> 12x 0418 4903</p> 	<p><b>71-22350-10</b> 0213 1579</p> 	<p><b>81-25986-20 K↔</b> 0242 1819 100x120 A SL RD FPM</p>  <p><b>81-23301-40 K↔</b> 0241 3332 105x130 AB SL LD FPM</p> 
BF 12 L 413 F BF 12L 413 F BF 12L 513 F	12 Cyl.		<p><b>03-12917-07</b>  0291 1536</p>   <p><b>03-13037-03</b>  0291 1550</p>    				<p><b>71-12917-00</b>  0240 2812</p>  <p><b>71-13037-00</b>  0424 1047</p> 		<p><b>71-25556-00</b>  0414 1486</p>  <p><b>71-23727-50</b> 12x 0418 4903</p> 	<p><b>71-22350-10</b> 0213 1579</p> 	<p><b>81-25986-20 K↔</b> 0242 1819 100x120 A SL RD FPM</p>  <p><b>81-23301-40 K↔</b> 0241 3332 105x130 AB SL LD FPM</p> 	
BF 12 L 413 FW	12 Cyl.		<p><b>03-13037-04</b> 0291 1545</p>    				<p><b>71-12917-00</b> 0240 2812</p>  <p><b>71-13037-00</b> 12x 0424 1047</p> 	<p><b>70-27506-00</b> 24x 0242 3697</p> 	<p><b>71-25556-00</b>  0414 1486</p>  <p><b>71-23727-50</b> 12x 0418 4903</p> 	<p><b>71-22350-10</b> 0213 1579</p>  <p><b>71-23601-10</b></p> 	<p><b>81-25986-20 K↔</b> 0242 1819 100x120 A SL RD FPM</p>  <p><b>81-23301-40 K↔</b> 0241 3332 105x130 AB SL LD FPM</p> 	



DEUTZ												
F 12 L 413 F 12L 413	12 Cyl. Ltr.		<p><b>03-12917-06</b> 0291 1516</p> 					<p><b>71-12917-00</b> 12x 0240 2812</p> 		<p><b>71-25556-00</b> 12x 0414 1486</p>  <p><b>71-20656-30</b> 12x 0336 2170</p> 	<p><b>71-22350-10</b> 0213 1579</p> 	<p><b>81-22593-20</b> K↔ 0241 3331 90x110 B SL RD FPM</p>  <p><b>81-23301-40</b> K↔ 0241 3332 105x130 AB SL LD FPM</p> 
F 12 L 413 F F 12L 413 F	12 Cyl.	<p><b>01-12917-42</b> 23 0291 1543</p> 	<p><b>03-12917-07</b> 23 0291 1536</p>  <p><b>03-13037-03</b> 23 0291 1550</p> 					<p><b>71-12917-00</b> 12x 0240 2812</p>  <p><b>71-13037-00</b> 12x 0424 1047</p> 		<p><b>71-25556-00</b> 12x 0414 1486</p>  <p><b>71-23727-50</b> 12x 0418 4903</p> 	<p><b>71-22350-10</b> 0213 1579</p> 	<p><b>81-25986-20</b> K↔ 0242 1819 100x120 A SL RD FPM</p>  <p><b>81-23301-40</b> K↔ 0241 3332 105x130 AB SL LD FPM</p> 
F 12L 413 FW	12 Cyl.	<p><b>01-13037-10</b> 0292 8987</p> 	<p><b>03-13037-04</b> 0291 1545</p> 					<p><b>71-13037-00</b> 12x 0424 1047</p>  <p><b>12-27506-01</b> 0242 3697 (24x)</p>  <p><b>70-27506-00</b> 0242 3697</p> 	<p><b>71-25556-00</b> 12x 0414 1486</p>  <p><b>71-23727-50</b> 12x 0418 4903</p> 	<p><b>71-22350-10</b> 0213 1579</p> 	<p><b>81-25986-20</b> K↔ 0242 1819 100x120 A SL RD FPM</p>  <p><b>81-23301-40</b> K↔ 0241 3332 105x130 AB SL LD FPM</p> 	

DEUTZ

















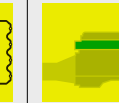
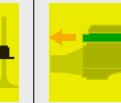
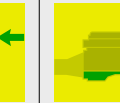

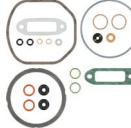

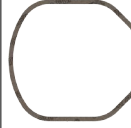





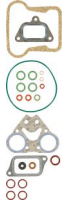

















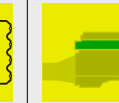
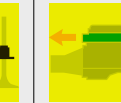
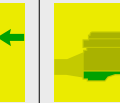















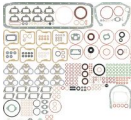







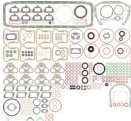

Ltr.

F 1L 511 D  
F 1L 511

















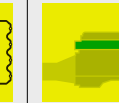
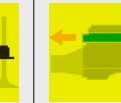
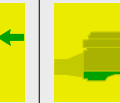

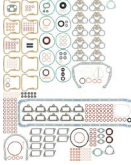



















1 Cyl.

















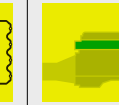
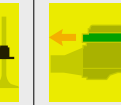
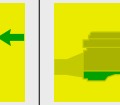













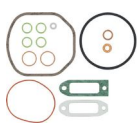

<p><b>01-25475-03</b> 0291 1564</p>	<p><b>03-25475-02</b> 0291 1563</p>			<p><b>61-25475-20</b> 0415 7654 102,6 Ø 1,1 mm</p> <p><b>61-25475-30</b> 0415 7468 102,6 Ø 1,5 mm</p> <p><b>61-25475-40</b> 0415 7656 102,6 Ø 1,2 mm</p> <p><b>61-25475-50</b> 0415 7467 102,6 Ø 1,45 mm</p> <p><b>61-25475-60</b> 0415 7658 102,6 Ø 1,3 mm</p> <p><b>61-25475-70</b> 0415 7466 102,6 Ø 1,4 mm</p> <p><b>61-25475-90</b> 0415 7470 102,6 Ø 1,6 mm</p>		<p><b>71-12612-30</b> 0337 1692</p>		<p><b>71-23988-10</b>  0223 0704</p> <p><b>71-16298-30</b>  0337 1689</p>		<p><b>81-17539-10</b> </p> <p>0116 3273 30x42 A SL LD ACM</p> <p><b>81-10425-00</b> </p> <p>0223 4498 62x80 A SL LD FPM</p>







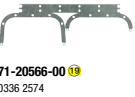









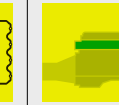
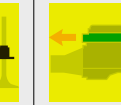
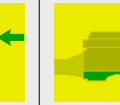



















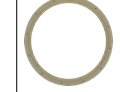







DEUTZ												
F 2L 511 D F 2L 511	2 Cyl. Ltr.	<b>01-25475-02</b> 	<b>03-25475-02</b> 0291 1563 			<b>61-25475-20</b> 2x 0415 7654 102,6 Ø 1,1 mm  <b>61-25475-30</b> 2x 0415 7468 102,6 Ø 1,5 mm  <b>61-25475-40</b> 2x 0415 7656 102,6 Ø 1,2 mm  <b>61-25475-50</b> 2x 0415 7467 102,6 Ø 1,45 mm  <b>61-25475-60</b> 2x 0415 7658 102,6 Ø 1,3 mm  <b>61-25475-70</b> 2x 0415 7466 102,6 Ø 1,4 mm  <b>61-25475-90</b> 2x 0415 7470 102,6 Ø 1,6 mm  	<b>71-12612-30</b> 2x 0337 1692  		<b>71-23988-10</b> 2x 0223 0704   <b>71-16298-30</b> 2x 0337 1689 		<b>81-17539-10</b>  2x 0116 3273 30x42 A SL LD ACM    <b>81-10425-00</b>  2x 0223 4498 62x80 A SL LD FPM  	
BF 8 L 513 LC BF 8 L 513-225 BF 8 L 513-243	8 Cyl.		<b>03-13037-03</b> 0291 1550 				<b>71-13037-00</b> 8x 0424 1047  		<b>71-25556-00</b>  8x 0414 1486   <b>71-23727-50</b> 8x 0418 4903 	<b>71-22105-20</b> 0213 1577 	<b>81-25986-20</b>  8x 0242 1819 100x120 A SL RD FPM    <b>81-23301-40</b>  8x 0241 3332 105x130 AB SL LD FPM  	



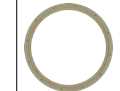





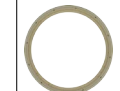



DEUTZ													
BF 8L 513	8 Cyl. Ltr.	<p><b>01-12917-40</b> </p> <p>0291 1539</p> 	<p><b>03-12917-07</b> </p> <p>0291 1536</p> 					<p><b>71-12917-00</b> </p> <p>0420 2812</p> 	<p>8x</p>	<p><b>71-25556-00</b> </p> <p>0414 1486</p> 	<p>8x</p>	<p><b>71-22105-20</b></p> <p>0213 1577</p> 	<p><b>81-25986-20</b> </p> <p>0242 1819 100x120 A SL RD FPM</p>  <p><b>81-23301-40</b> </p> <p>0241 3332 105x130 AB SL LD FPM</p> 
F 8 L 513	8 Cyl.	<p><b>01-13037-17</b> </p> <p>0292 8809 +0242 1819 +0242 1820</p> 	<p><b>03-13037-03</b></p> <p>0291 1550</p> 					<p><b>71-13037-00</b></p> <p>0424 1047</p> 	<p>8x</p>	<p><b>71-25556-00</b> </p> <p>0414 1486</p> 	<p>8x</p>	<p><b>71-22105-20</b></p> <p>0213 1577</p> 	<p><b>81-25986-20</b> </p> <p>0242 1819 100x120 A SL RD FPM</p>  <p><b>81-23301-40</b> </p> <p>0241 3332 105x130 AB SL LD FPM</p> 
F 8 L 513	8 Cyl.	<p><b>01-13037-17</b> </p> <p>0292 8809 +0242 1819 +0242 1820</p> 	<p><b>03-13037-03</b></p> <p>0291 1550</p> 					<p><b>71-13037-00</b> </p> <p>0424 1047</p> 	<p>8x</p>	<p><b>71-25556-00</b> </p> <p>0414 1486</p> 	<p>8x</p>	<p><b>71-22105-20</b></p> <p>0213 1577</p> 	<p><b>81-25986-20</b> </p> <p>0242 1819 100x120 A SL RD FPM</p>  <p><b>81-23301-40</b> </p> <p>0241 3332 105x130 AB SL LD FPM</p> 

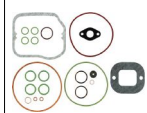

DEUTZ													
BF 10L 513	10 Cyl. Ltr.	<p><b>01-12974-15</b> </p> <p>0291 1554</p> 	<p><b>03-12917-07</b> </p> <p>0291 1536</p> 					<p><b>71-12917-00</b> </p> <p>0240 2812</p> 	<p><b>71-12917-00</b> </p> <p>0424 1047</p> 	<p><b>71-25556-00</b> </p> <p>0414 1486</p> 	<p><b>71-23727-50</b> </p> <p>0418 4903</p> 	<p><b>81-25986-20</b> </p> <p>0242 1819 100x120 A SL RD FPM</p> 	<p><b>81-23301-40</b> </p> <p>0241 3332 105x130 AB SL LD FPM</p> 
F 10L 513	10 Cyl.	<p><b>01-13037-02</b></p> <p>0292 8813 +0242 1819 +0242 1820</p>	<p><b>03-12917-07</b></p> <p>0291 1536</p> 					<p><b>71-13037-00</b> </p> <p>0424 1047</p> 		<p><b>71-25556-00</b> </p> <p>0414 1486</p> 	<p><b>71-23727-50</b> </p> <p>0418 4903</p> 	<p><b>81-25986-20</b> </p> <p>0242 1819 100x120 A SL RD FPM</p> 	<p><b>81-23301-40</b> </p> <p>0241 3332 105x130 AB SL LD FPM</p> 
F 1L 514 F 1 L 514	1 Cyl.		<p><b>03-12065-05</b></p> <p>0330 5749</p> 					<p><b>71-12065-10</b></p> <p>0241 2311</p> 		<p><b>71-09761-30</b>  </p> <p>0292 9305</p> 			

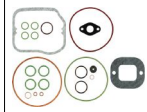
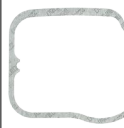
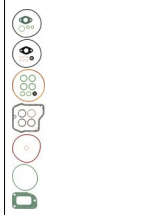
DEUTZ												
F 2L 514	2 Cyl. Ltr.		<p>03-12065-05 0330 5749</p> 					<p>71-12065-10 2x 0241 2311</p> 		<p>71-09761-30 4x 0292 9305</p> 	<p>71-15148-00 2x 0336 7527</p> 	
F 3L 514	3 Cyl.		<p>03-12065-05 0330 5749</p> 					<p>71-12065-10 3x 0241 2311</p> 		<p>71-09761-30 6x 0292 9305</p> 		
F 1L 712 F 1L 812	1 Cyl.		<p>03-12612-04 0291 0165</p> 					<p>71-12612-30 0337 1692</p> 		<p>71-23988-10 0223 0704</p> 		<p>81-17085-00 K↔K↔ 2x 0116 3205 60x80 A SL OD NBR</p> 
F 2L 712 F 2L 812	2 Cyl.		<p>03-12612-04 0291 0165</p> 					<p>71-12612-30 2x 0337 1692</p> 		<p>71-23988-10 2x 0223 0704</p> 		<p>81-17085-00 K↔K↔ 2x 0116 3205 60x80 A SL OD NBR</p> 
F 3L 712 F 3L 812	3 Cyl.		<p>03-12612-04 0291 0165</p> 					<p>71-12612-30 3x 0337 1692</p> 		<p>71-23988-10 3x 0223 0704</p> 	<p>71-19562-00 19 0336 2573</p> 	<p>81-20481-30 K↔↔ 0415 0392 115x140 A SL LD FPM/ACM</p> 
F 4L 712 F 4L 812	4 Cyl.		<p>03-12612-04 0291 0165</p> 					<p>71-12612-30 4x 0337 1692</p> 		<p>71-23988-10 4x 0223 0704</p> 	<p>71-19571-10 20 0213 6719</p> 	<p>81-20481-30 K↔↔ 0415 0392 115x140 A SL LD FPM/ACM</p> 

DEUTZ														
F 6 L 712 F 6 L 712 F 6 L 812 F 6 L 812 D	6 Cyl. Ltr.		03-12612-04 0291 0165 					71-12612-30 0337 1692 	6x		71-23988-10  0223 0704  71-16298-30  0337 1689 	6x	71-19572-10  0213 6720  71-20940-00  0336 2581 	81-20481-30  0415 0392 115x140 A SL LD FPM/ACM 
F 6 L 714	6 Cyl.		03-12065-06 0291 1586 					71-12065-10 0241 2311 	6x		71-09761-30  0292 9305 	12x	71-15960-10 0336 9074 	81-21395-10  0116 0383 150x172 A LD MVQ 
F 8 L 714	8 Cyl.		03-12065-06 0291 1586 					71-12065-10 0241 2311 	8x		71-09761-30  0292 9305 	16x	71-11967-10 0336 9032 	81-21395-10  0116 0383 150x172 A LD MVQ 
F 10 L 714	10 Cyl.		03-12065-06 0291 1586 					71-12065-10 0241 2311 	10x		71-09761-30  0292 9305 	20x		81-21395-10  0116 0383 150x172 A LD MVQ 
BF 12 L 714	12 Cyl.		03-12065-06 0291 1586 					71-12065-10 0241 2311 	12x		71-09761-30  0292 9305 	24x		81-21395-10  0116 0383 150x172 A LD MVQ 

<b>DEUTZ</b> 											
BF 8 M 716 F 8 M 716 8 Cyl. Ltr.		03-2355-02 0291 0179 4925041→ 			61-23550-00 8x 0337 3421 157,3 Ø 1 mm 		71-21556-10 8x 0347 0138 				
BF 16 M 716 16 Cyl.		03-2355-02 0291 0179 4982892→ 			61-23550-00 16x 0337 3421 157,3 Ø 1 mm 		71-21556-10 16x 0347 0138 				
BA 12M 816 12 Cyl.		03-25755-02 0291 1558 			61-25755-10 12x 0405 0720 165 Ø 1,5 mm 		71-25287-10 12x 0215 9580 	71-24207-10 12x 0215 6432 	71-22329-10 0337 4670 		



















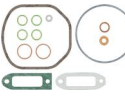

DEUTZ

F 2L 912

2 Cyl.

Ltr.

										
<p><b>01-12612-45</b> 0291 0198</p> 	<p><b>03-12612-05</b> 0293 1476</p> 			<p><b>61-25475-20</b> 2x 0415 7654 102,6 Ø 1,1 mm</p> <p><b>61-25475-30</b> 2x 0415 7468 102,6 Ø 1,5 mm</p> <p><b>61-25475-40</b> 2x 0415 7656 102,6 Ø 1,2 mm</p> <p><b>61-25475-50</b> 2x 0415 7467 102,6 Ø 1,45 mm</p> <p><b>61-25475-60</b> 2x 0415 7658 102,6 Ø 1,3 mm</p> <p><b>61-25475-70</b> 2x 0415 7466 102,6 Ø 1,4 mm</p> <p><b>61-25475-90</b> 2x 0415 7470 102,6 Ø 1,6 mm</p> 		<p><b>71-12612-30</b> 2x 0337 1692</p> 		<p><b>71-23988-10</b> 2x 0223 0704</p>  <p><b>71-16298-30</b> 2x 0337 1689</p> 		<p><b>81-17085-00</b> 2x 0116 3205 60x80 A SL OD NBR</p> 







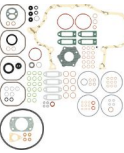
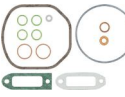

**DEUTZ**

F 3L 912 3 Cyl. Ltr.  
F 3L 913

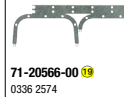
<p><b>01-12612-51</b> 0292 8973</p>	<p><b>03-12612-05</b> 0293 1476</p>			<p><b>61-25475-20</b> 3x 0415 7654 102,6 Ø 1,1 mm</p>		<p><b>71-12612-30</b> 3x 0337 1692</p>		<p><b>71-23988-10</b> 3x 0223 0704</p>	<p><b>71-19562-00</b> 0336 2573</p>	<p><b>81-21527-30 K</b> 0423 2266 65x85 A FIL RD FPM/ACM 4733555→</p>
<p><b>01-12612-55</b> 0291 0182</p>				<p><b>61-25475-30</b> 3x 0415 7468 102,6 Ø 1,5 mm</p>				<p><b>71-16298-30</b> 3x 0337 1689</p>		<p><b>81-20481-30 K</b> 0415 0392 115x140 A SL LD FPM/ACM 4733555→</p>
				<p><b>61-25475-40</b> 3x 0415 7656 102,6 Ø 1,2 mm</p>						
				<p><b>61-25475-50</b> 3x 0415 7467 102,6 Ø 1,45 mm</p>						
				<p><b>61-25475-60</b> 3x 0415 7658 102,6 Ø 1,3 mm</p>						
				<p><b>61-25475-70</b> 3x 0415 7466 102,6 Ø 1,4 mm</p>						
				<p><b>61-25475-90</b> 3x 0415 7470 102,6 Ø 1,6 mm</p>						

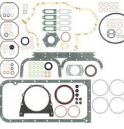
**DEUTZ**

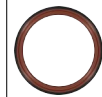
F 4 L 912 4 Cyl. Ltr.  
F 4L 912

<p><b>01-12612-49</b> 0292 8974</p> 	<p><b>03-12612-05</b> 0293 1476</p> 			<p><b>61-25475-20</b> 4x 0415 7654 102,6 Ø 1,1 mm</p>		<p><b>71-12612-30</b> 4x 0337 1692</p> 		<p><b>71-23988-10</b> 4x 0223 0704</p> 	<p><b>71-19571-10</b> 20 0213 6719</p> 	<p><b>81-21527-30</b> K 0423 2266 65x85 A FIL RD FPM/ACM 4739685→</p> 
<p><b>01-12612-52</b> 0292 8974</p> 				<p><b>61-25475-30</b> 4x 0415 7468 102,6 Ø 1,5 mm</p>				<p><b>71-16298-30</b> 4x 0337 1689</p> 	<p><b>71-20566-00</b> 10 0336 2574</p> 	<p><b>81-20481-30</b> K 0415 0392 115x140 A SL LD FPM/ACM 4739685→</p> 
<p><b>01-42840-01</b></p>				<p><b>61-25475-40</b> 4x 0415 7656 102,6 Ø 1,2 mm</p>						
				<p><b>61-25475-50</b> 4x 0415 7467 102,6 Ø 1,45 mm</p>						
				<p><b>61-25475-60</b> 4x 0415 7658 102,6 Ø 1,3 mm</p>						
				<p><b>61-25475-70</b> 4x 0415 7466 102,6 Ø 1,4 mm</p>						
				<p><b>61-25475-90</b> 4x 0415 7470 102,6 Ø 1,6 mm</p> 						

DEUTZ



F 5L 912  
F 5L 912 D

5 Cyl.







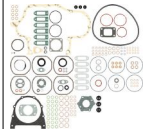
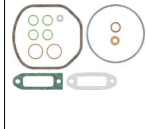

Ltr.

<p><b>01-12612-46</b> 0291 0228</p>	<p><b>03-12612-05</b> 0293 1476</p>			<p><b>61-25475-20</b> 5x 0415 7654 102,6 Ø 1,1 mm</p> <p><b>61-25475-30</b> 5x 0415 7468 102,6 Ø 1,5 mm</p> <p><b>61-25475-40</b> 5x 0415 7656 102,6 Ø 1,2 mm</p> <p><b>61-25475-50</b> 5x 0415 7467 102,6 Ø 1,45 mm</p> <p><b>61-25475-60</b> 5x 0415 7658 102,6 Ø 1,3 mm</p> <p><b>61-25475-70</b> 5x 0415 7466 102,6 Ø 1,4 mm</p> <p><b>61-25475-90</b> 5x 0415 7470 102,6 Ø 1,6 mm</p>		<p><b>71-12612-30</b> 5x 0337 1692</p>		<p><b>71-23988-10</b> 5x 0223 0704</p> <p><b>71-16298-30</b> 5x 0337 1689</p>	<p><b>71-23849-00</b> 0224 0933</p>	<p><b>81-21527-30 K</b> 0423 2266 65x85 A FIL RD FPM/ACM</p> <p><b>81-20461-30 K</b> 0415 0392 115x140 A SL LD FPM/ACM</p>

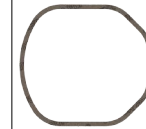
DEUTZ





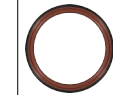













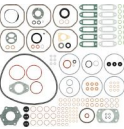

BF 6 L 912  
BF 6L 912

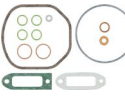
6 Cyl.  
Ltr.

<p><b>01-12612-58</b> 0291 0256</p> 	<p><b>03-12612-05</b> 0293 1476</p> 			<p><b>61-25475-20</b> 6x 0415 7654 102,6 Ø 1,1 mm</p> <p><b>61-25475-30</b> 6x 0415 7468 102,6 Ø 1,5 mm</p> <p><b>61-25475-40</b> 6x 0415 7656 102,6 Ø 1,2 mm</p> <p><b>61-25475-50</b> 6x 0415 7467 102,6 Ø 1,45 mm</p> <p><b>61-25475-60</b> 6x 0415 7658 102,6 Ø 1,3 mm</p> <p><b>61-25475-70</b> 6x 0415 7466 102,6 Ø 1,4 mm</p> <p><b>61-25475-90</b> 6x 0415 7470 102,6 Ø 1,6 mm</p> 		<p><b>71-12612-30</b> 6x 0337 1692</p> 		<p><b>71-23988-10</b> 6x 0223 0704</p>  <p><b>71-16298-30</b> 6x 0337 1689</p> 	<p><b>71-19572-10</b> 20 0213 6720</p>  <p><b>71-20940-00</b> 19 0336 2581</p> 	<p><b>81-21527-30</b> K 0423 2266 65x85 A FIL RD FPM/ACM</p>  <p><b>81-20481-30</b> K 0415 0392 115x140 A SL LD FPM/ACM</p> 

**DEUTZ**

F 6L 912 6 Cyl. Ltr.

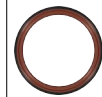
										
<p><b>01-12612-48</b> 0291 0184</p>  <p><b>01-12612-53</b> 0292 8976</p> 	<p><b>03-12612-05</b> 0293 1476</p> 			<p><b>61-25475-20</b> 6x 0415 7654 102,6 Ø 1,1 mm</p> <p><b>61-25475-30</b> 6x 0415 7468 102,6 Ø 1,5 mm</p> <p><b>61-25475-40</b> 6x 0415 7656 102,6 Ø 1,2 mm</p> <p><b>61-25475-50</b> 6x 0415 7467 102,6 Ø 1,45 mm</p> <p><b>61-25475-60</b> 6x 0415 7658 102,6 Ø 1,3 mm</p> <p><b>61-25475-70</b> 6x 0415 7466 102,6 Ø 1,4 mm</p> <p><b>61-25475-90</b> 6x 0415 7470 102,6 Ø 1,6 mm</p> 		<p><b>71-12612-30</b> 6x 0337 1692</p> 		<p><b>71-23988-10</b> 6x 0223 0704</p>  <p><b>71-16298-30</b> 6x 0337 1689</p> 	<p><b>71-19572-10</b> 20 0213 6720</p>  <p><b>71-20940-00</b> 19 0336 2581</p> 	<p><b>81-21527-30</b> K↔ 0423 2266 65x85 A FIL RD FPM/ACM ↔ 4746213 →</p>  <p><b>81-20481-30</b> K↔ 0415 0392 115x140 A SL LD FPM/ACM ↔ 4746213 →</p> 





















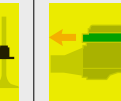

**DEUTZ**  
 F 6 L 912 6 Cyl. Ltr.

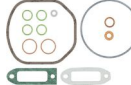



















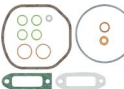

<p><b>01-12612-48</b> 0291 0184</p>	<p><b>03-12612-05</b> 0293 1476</p>			<p><b>61-25475-20</b> 6x 0415 7654 102,6 Ø 1,1 mm</p>		<p><b>71-12612-30</b> 6x 0337 1692</p>		<p><b>71-23988-10</b> 6x 0223 0704</p>	<p><b>71-19572-10</b> 20 0213 6720</p>	<p><b>81-21527-30</b> K 0423 2266 65x85 A FIL RD FPM/ACM</p>
<p><b>01-12612-53</b> 0292 8976</p>				<p><b>61-25475-30</b> 6x 0415 7468 102,6 Ø 1,5 mm</p>				<p><b>71-16298-30</b> 6x 0337 1689</p>	<p><b>71-20940-00</b> 19 0336 2581</p>	<p><b>81-20481-30</b> K 0415 0392 115x140 A SL LD FPM/ACM</p>
				<p><b>61-25475-40</b> 6x 0415 7656 102,6 Ø 1,2 mm</p>						
				<p><b>61-25475-50</b> 6x 0415 7467 102,6 Ø 1,45 mm</p>						
				<p><b>61-25475-60</b> 6x 0415 7658 102,6 Ø 1,3 mm</p>						
				<p><b>61-25475-70</b> 6x 0415 7466 102,6 Ø 1,4 mm</p>						
				<p><b>61-25475-90</b> 6x 0415 7470 102,6 Ø 1,6 mm</p>						

**DEUTZ**







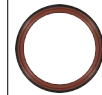









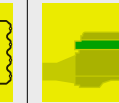
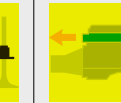
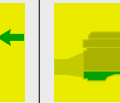

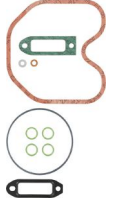
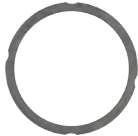











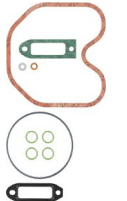

BF 4 L 913 4 Cyl. Ltr.  
 BF 4L 913  
 BF 4 L 913 T  
 BF 4L 913 T

		<p><b>03-12612-05</b> 0293 1476</p>			<p><b>61-25475-20</b> 4x 0415 7654 102,6 Ø 1,1 mm</p> <p><b>61-25475-30</b> 4x 0415 7468 102,6 Ø 1,5 mm</p> <p><b>61-25475-40</b> 4x 0415 7656 102,6 Ø 1,2 mm</p> <p><b>61-25475-50</b> 4x 0415 7467 102,6 Ø 1,45 mm</p> <p><b>61-25475-60</b> 4x 0415 7658 102,6 Ø 1,3 mm</p> <p><b>61-25475-70</b> 4x 0415 7466 102,6 Ø 1,4 mm</p> <p><b>61-25475-90</b> 4x 0415 7470 102,6 Ø 1,6 mm</p>		<p><b>71-12612-30</b> 4x 0337 1692</p>		<p><b>71-23988-10</b> 4x 0223 0704</p> <p><b>71-16298-30</b> 4x 0337 1689</p>	<p><b>71-19571-10</b> 20 0213 6719</p> <p><b>71-20566-00</b> 10 0336 2574</p>	<p><b>81-21527-30</b> K↔ 0423 2266 65x85 A FIL RD FPM/ACM</p> <p><b>81-20481-30</b> K↔ 0415 0392 115x140 A SL LD FPM/ACM</p>



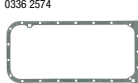















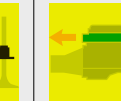



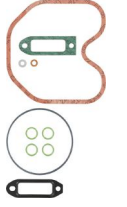







DEUTZ												
F 4 L 913 F 4L 913	4 Cyl. Ltr.	<p><b>01-12612-28</b> 0291 1535</p>  <p><b>01-12612-54</b> 0291 1535 +0415 7236 +0423 0392 +0336 2574 +0415 2348</p> 	<p><b>03-12612-05</b> 0293 1476</p> 			<p><b>61-25475-20</b> 4x 0415 7654 102,6 Ø 1,1 mm</p> <p><b>61-25475-30</b> 4x 0415 7468 102,6 Ø 1,5 mm</p> <p><b>61-25475-40</b> 4x 0415 7656 102,6 Ø 1,2 mm</p> <p><b>61-25475-50</b> 4x 0415 7467 102,6 Ø 1,45 mm</p> <p><b>61-25475-60</b> 4x 0415 7658 102,6 Ø 1,3 mm</p> <p><b>61-25475-70</b> 4x 0415 7466 102,6 Ø 1,4 mm</p> <p><b>61-25475-90</b> 4x 0415 7470 102,6 Ø 1,6 mm</p> 	<p><b>71-12612-30</b> 4x 0337 1692</p> 		<p><b>71-23988-10</b> 4x 0223 0704</p>  <p><b>71-16298-30</b> 4x 0337 1689</p> 	<p><b>71-19571-10</b> 20 0213 6719</p>  <p><b>71-20566-00</b> 10 0336 2574</p> 	<p><b>81-21527-30</b> K↔ 0423 2266 65x85 A FIL RD FPM/ACM</p>  <p><b>81-20481-30</b> K↔ 0415 0392 115x140 A SL LD FPM/ACM</p> 	

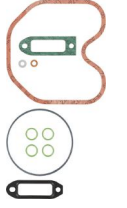















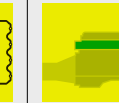
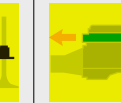
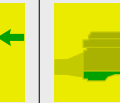

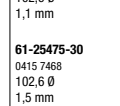
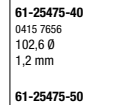
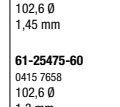
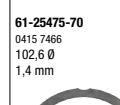

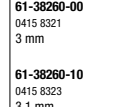
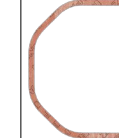

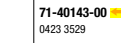

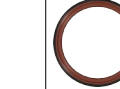
<b>DEUTZ</b> 											
BF 6 L 913 BF 6L 913 BF 6L 913 C BF 6L 913 T BF 6 L 913 T  6 Cyl. Ltr.	 <p><b>01-12612-50</b> 0291 0279</p>  <p><b>01-12612-56</b> 0292 9333</p>	 <p><b>03-12612-05</b> 0293 1476</p>			<p><b>61-25475-20</b> 6x 0415 7654 102,6 Ø 1,1 mm</p> <p><b>61-25475-30</b> 6x 0415 7468 102,6 Ø 1,5 mm</p> <p><b>61-25475-40</b> 6x 0415 7656 102,6 Ø 1,2 mm</p> <p><b>61-25475-50</b> 6x 0415 7467 102,6 Ø 1,45 mm</p> <p><b>61-25475-60</b> 6x 0415 7658 102,6 Ø 1,3 mm</p> <p><b>61-25475-70</b> 6x 0415 7466 102,6 Ø 1,4 mm</p> <p><b>61-25475-90</b> 6x 0415 7470 102,6 Ø 1,6 mm</p> 		<p><b>71-12612-30</b> 6x 0337 1692</p> 		<p><b>71-23988-10</b> 6x 0223 0704</p>  <p><b>71-16298-30</b> 6x 0337 1689</p> 	<p><b>71-19572-10</b> 20 0213 6720</p>  <p><b>71-20940-00</b> 19 0336 2581</p> 	<p><b>81-21527-30</b> K 0423 2266 65x85 A FIL RD FPM/ACM</p>  <p><b>81-20481-30</b> K 0415 0392 115x140 A SL LD FPM/ACM</p> 

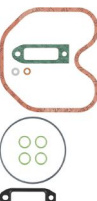
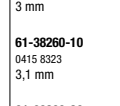
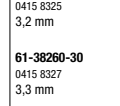
DEUTZ												
F 6 L 913 F 6L 913	6 Cyl. Ltr.	<p><b>01-12612-47</b> 0291 0278</p> <p><b>01-12612-57</b> 0291 0278</p>	<p><b>03-12612-05</b> 0293 1476</p>			<p><b>61-25475-20</b> 6x 0415 7654 102,6 Ø 1,1 mm</p> <p><b>61-25475-30</b> 6x 0415 7468 102,6 Ø 1,5 mm</p> <p><b>61-25475-40</b> 6x 0415 7656 102,6 Ø 1,2 mm</p> <p><b>61-25475-50</b> 6x 0415 7467 102,6 Ø 1,45 mm</p> <p><b>61-25475-60</b> 6x 0415 7658 102,6 Ø 1,3 mm</p> <p><b>61-25475-70</b> 6x 0415 7466 102,6 Ø 1,4 mm</p> <p><b>61-25475-90</b> 6x 0415 7470 102,6 Ø 1,6 mm</p>	<p><b>71-12612-30</b> 6x 0337 1692</p>		<p><b>71-23988-10</b> 6x 0223 0704</p> <p><b>71-16298-30</b> 6x 0337 1689</p>	<p><b>71-19572-10</b> 20 0213 6720</p> <p><b>71-20940-00</b> 19 0336 2581</p>	<p><b>81-21527-30</b> K↔ 0423 2266 65x85 A FIL RD FPM/ACM</p> <p><b>81-20481-30</b> K↔ 0415 0392 115x140 A SL LD FPM/ACM</p>	
BF 3L 914	3 Cyl.	<p><b>01-40542-01</b> 0293 7523</p>	<p><b>03-40542-01</b> 0293 7521</p>			<p><b>61-38260-00</b> 3x 0415 8321 3 mm</p> <p><b>61-38260-10</b> 3x 0415 8323 3,1 mm</p> <p><b>61-38260-20</b> 3x 0415 8325 3,2 mm</p> <p><b>61-38260-30</b> 3x 0415 8327 3,3 mm</p>	<p><b>71-40542-00</b> 3x 0423 8230</p>	<p><b>70-27408-00</b> 6x 0415 3728</p>	<p><b>71-23988-10</b> 3x 0223 0704</p> <p><b>71-40143-00</b> 3x 0423 3529</p>	<p><b>71-19562-00</b> 0336 2573</p>	<p><b>81-21527-30</b> K↔ 0423 2266 65x85 A FIL RD FPM/ACM</p> <p><b>81-20481-30</b> K↔ 0415 0392 115x140 A SL LD FPM/ACM</p>	

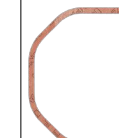
DEUTZ												
D 914 L3 F 3L 914	3 Cyl. Ltr.	 <p><b>01-40542-01</b> 0293 7523</p>	 <p><b>03-40542-01</b> 0293 7521</p>			<p><b>61-25475-20</b> 3x 0415 7654 102,6 Ø 1,1 mm</p> <p><b>61-25475-30</b> 3x 0415 7468 102,6 Ø 1,5 mm</p> <p><b>61-25475-40</b> 3x 0415 7656 102,6 Ø 1,2 mm</p> <p><b>61-25475-50</b> 3x 0415 7467 102,6 Ø 1,45 mm</p> <p><b>61-25475-60</b> 3x 0415 7658 102,6 Ø 1,3 mm</p> <p><b>61-25475-70</b> 3x 0415 7466 102,6 Ø 1,4 mm</p> 		<p><b>71-40542-00</b> 3x 0423 8230</p> 	<p><b>70-27408-00</b> 6x 0415 3728</p> 	<p><b>71-23988-10</b>  3x 0223 0704</p>  <p><b>71-40143-00</b>  3x 0423 3529</p> 	<p><b>71-19562-00</b> 0336 2573</p> 	<p><b>81-21527-30</b>  <b>K</b> 0423 2266 65x85 A FIL RD FPM/ACM</p>  <p><b>81-20481-30</b>  <b>K</b> 0415 0392 115x140 A SL LD FPM/ACM</p> 
BF 4L 914	4 Cyl.	 <p><b>01-40542-02</b> 0293 7524</p>	 <p><b>03-40542-01</b> 0293 7521</p>			<p><b>61-38260-00</b> 4x 0415 8321 3 mm</p> <p><b>61-38260-10</b> 4x 0415 8323 3,1 mm</p> <p><b>61-38260-20</b> 4x 0415 8325 3,2 mm</p> <p><b>61-38260-30</b> 4x 0415 8327 3,3 mm</p> 		<p><b>71-40542-00</b> 4x 0423 8230</p> 		<p><b>71-23988-10</b>  4x 0223 0704</p>  <p><b>71-40143-00</b>  4x 0423 3529</p> 	<p><b>71-19571-10</b> 0213 6719</p>  <p><b>71-20566-00</b> 0336 2574</p> 	<p><b>81-21527-30</b>  <b>K</b> 0423 2266 65x85 A FIL RD FPM/ACM</p>  <p><b>81-20481-30</b>  <b>K</b> 0415 0392 115x140 A SL LD FPM/ACM</p> 

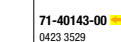

DEUTZ												
D 914 L4	4 Cyl. Ltr.	<p><b>01-40542-02</b> 0293 7524</p> 	<p><b>03-40542-01</b> 0293 7521</p> 			<p><b>61-25475-20</b> 4x 0415 7654 102,6 Ø 1,1 mm</p> <p><b>61-25475-30</b> 4x 0415 7468 102,6 Ø 1,5 mm</p> <p><b>61-25475-40</b> 4x 0415 7656 102,6 Ø 1,2 mm</p> <p><b>61-25475-50</b> 4x 0415 7467 102,6 Ø 1,45 mm</p> <p><b>61-25475-60</b> 4x 0415 7658 102,6 Ø 1,3 mm</p> <p><b>61-25475-70</b> 4x 0415 7466 102,6 Ø 1,4 mm</p> 		<p><b>71-40542-00</b> 4x 0423 8230</p> 		<p><b>71-23988-10</b> 4x 0223 0704</p>  <p><b>71-40143-00</b> 4x 0423 3529</p> 	<p><b>71-19571-10</b> 0213 6719</p>  <p><b>71-20566-00</b> 0336 2574</p> 	<p><b>81-21527-30 K</b> 4x 0423 2266 65x85 A FIL RD FPM/ACM</p>  <p><b>81-20481-30 K</b> 4x 0415 0392 115x140 A SL LD FPM/ACM</p> 
F 4L 914	4 Cyl.	<p><b>01-40542-02</b> 0293 7524</p> 	<p><b>03-40542-01</b> 0293 7521</p> 			<p><b>61-25475-20</b> 4x 0415 7654 102,6 Ø 1,1 mm</p> <p><b>61-25475-30</b> 4x 0415 7468 102,6 Ø 1,5 mm</p> <p><b>61-25475-40</b> 4x 0415 7656 102,6 Ø 1,2 mm</p> <p><b>61-25475-50</b> 4x 0415 7467 102,6 Ø 1,45 mm</p> <p><b>61-25475-60</b> 4x 0415 7658 102,6 Ø 1,3 mm</p> <p><b>61-25475-70</b> 4x 0415 7466 102,6 Ø 1,4 mm</p> 		<p><b>71-40542-00</b> 4x 0423 8230</p> 		<p><b>71-23988-10</b> 4x 0223 0704</p>  <p><b>71-40143-00</b> 4x 0423 3529</p> 	<p><b>71-19571-10</b> 0213 6719</p> 	<p><b>81-21527-30 K</b> 4x 0423 2266 65x85 A FIL RD FPM/ACM</p>  <p><b>81-20481-30 K</b> 4x 0415 0392 115x140 A SL LD FPM/ACM</p> 















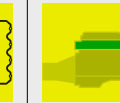
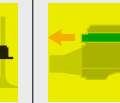
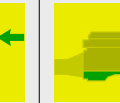
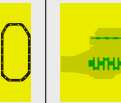
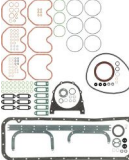
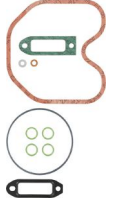

DEUTZ												
D 914 L5 F 5L 914	5 Cyl. Ltr.		 <b>03-40542-01</b> 0293 7521			 <b>61-25475-20</b> 5x 0415 7654 102,6 Ø 1,1 mm   <b>61-25475-30</b> 5x 0415 7468 102,6 Ø 1,5 mm   <b>61-25475-40</b> 5x 0415 7656 102,6 Ø 1,2 mm   <b>61-25475-50</b> 5x 0415 7467 102,6 Ø 1,45 mm   <b>61-25475-60</b> 5x 0415 7658 102,6 Ø 1,3 mm   <b>61-25475-70</b> 5x 0415 7466 102,6 Ø 1,4 mm	 <b>71-40542-00</b> 5x 0423 8230   <b>70-27408-00</b> 10x 0415 3728	 <b>71-23988-10</b> 5x 0223 0704   <b>71-40143-00</b> 5x 0423 3529	 <b>71-23849-00</b> 0224 0933	 <b>81-21527-30</b> K↔ 0423 2266 65x85 A FIL RD FPM/ACM   <b>81-20481-30</b> K↔ 0415 0392 115x140 A SL LD FPM/ACM		
BF 6L 914 BF 6L 914 C	6 Cyl.	 <b>01-40542-05</b> 0293 7526	 <b>03-40542-01</b> 0293 7521		 <b>61-38260-00</b> 6x 0415 8321 3 mm   <b>61-38260-10</b> 6x 0415 8323 3,1 mm   <b>61-38260-20</b> 6x 0415 8325 3,2 mm   <b>61-38260-30</b> 6x 0415 8327 3,3 mm	 <b>71-40542-00</b> 6x 0423 8230	 <b>71-23988-10</b> 6x 0223 0704   <b>71-40143-00</b> 6x 0423 3529	 <b>71-19572-10</b> 0213 6720   <b>71-20940-00</b> X 0336 2581	 <b>81-21527-30</b> K↔ 0423 2266 65x85 A FIL RD FPM/ACM   <b>81-20481-30</b> K↔ 0415 0392 115x140 A SL LD FPM/ACM			

DEUTZ

D 914 L6











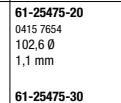
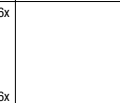
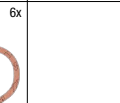

6 Cyl.

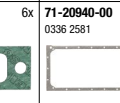
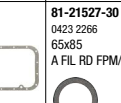
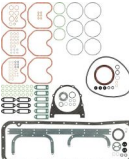
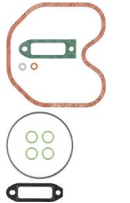















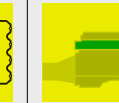
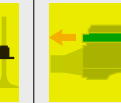
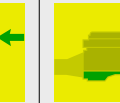

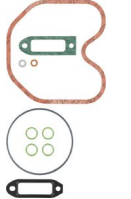











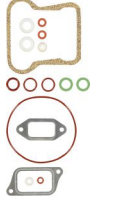





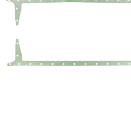





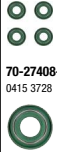

Ltr.

										
<p><b>01-40542-04</b> 0293 7715</p> 	<p><b>03-40542-01</b> 0293 7521</p> 			<p><b>61-25475-20</b> 6x 0415 7654 102,6 Ø 1,1 mm</p> <p><b>61-25475-30</b> 6x 0415 7468 102,6 Ø 1,5 mm</p> <p><b>61-25475-40</b> 6x 0415 7656 102,6 Ø 1,2 mm</p> <p><b>61-25475-50</b> 6x 0415 7467 102,6 Ø 1,45 mm</p> <p><b>61-25475-60</b> 6x 0415 7658 102,6 Ø 1,3 mm</p> <p><b>61-25475-70</b> 6x 0415 7466 102,6 Ø 1,4 mm</p> 		<p><b>71-40542-00</b> 6x 0423 8230</p> 	<p><b>70-27408-00</b> 12x 0415 3728</p> 	<p><b>71-23988-10</b> 6x 0223 0704</p>  <p><b>71-40143-00</b> 6x 0423 3529</p> 	<p><b>71-19572-10</b> 0213 6720</p>  <p><b>71-20940-00</b> 0336 2581</p> 	<p><b>81-21527-30</b> K↔ 0423 2266 65x85 A FIL RD FPM/ACM</p>  <p><b>81-20481-30</b> K↔ 0415 0392 115x140 A SL LD FPM/ACM</p> 

















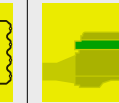
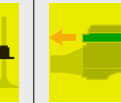
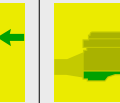

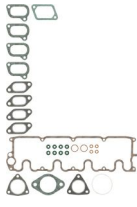
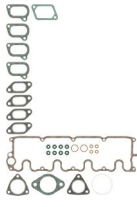







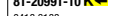
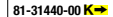









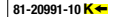



F 6L 914

6 Cyl.





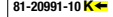













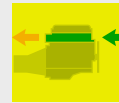





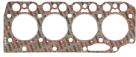







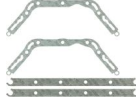









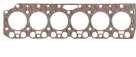





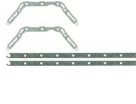









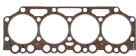

										
<p><b>01-40542-04</b> 0293 7715</p> 	<p><b>03-40542-01</b> 0293 7521</p> 			<p><b>61-25475-20</b> 6x 0415 7654 102,6 Ø 1,1 mm</p> <p><b>61-25475-30</b> 6x 0415 7468 102,6 Ø 1,5 mm</p> <p><b>61-25475-40</b> 6x 0415 7656 102,6 Ø 1,2 mm</p> <p><b>61-25475-50</b> 6x 0415 7467 102,6 Ø 1,45 mm</p> <p><b>61-25475-60</b> 6x 0415 7658 102,6 Ø 1,3 mm</p> <p><b>61-25475-70</b> 6x 0415 7466 102,6 Ø 1,4 mm</p> 		<p><b>71-40542-00</b> 6x 0423 8230</p> 		<p><b>71-23988-10</b> 6x 0223 0704</p>  <p><b>71-40143-00</b> 6x 0423 3529</p> 	<p><b>71-20940-00</b> 0336 2581</p> 	<p><b>81-21527-30</b> K↔ 0423 2266 65x85 A FIL RD FPM/ACM</p>  <p><b>81-20481-30</b> K↔ 0415 0392 115x140 A SL LD FPM/ACM</p> 





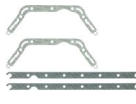

















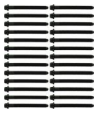













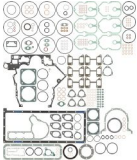



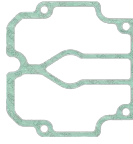

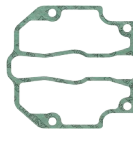



DEUTZ												
TCD 914 L6	6 Cyl. Ltr.	<p><b>01-40542-05</b> 0293 7526</p> 	<p><b>03-40542-01</b> 0293 7521</p> 			<p><b>61-38260-00</b> 6x 0415 8321 3 mm</p> <p><b>61-38260-10</b> 6x 0415 8323 3,1 mm</p> <p><b>61-38260-20</b> 6x 0415 8325 3,2 mm</p> <p><b>61-38260-30</b> 6x 0415 8327 3,3 mm</p> 		<p><b>71-40542-00</b> 6x 0423 8230</p> 		<p><b>71-23988-10</b>  6x 0223 0704</p>  <p><b>71-40143-00</b>  6x 0423 3529</p> 	<p><b>71-19572-10</b> 0213 6720</p>  <p><b>71-20940-00</b> 0336 2581</p> 	<p><b>81-20481-30</b>  <b>K</b></p> <p>0415 0392 115x140 A SL LD FPM/ACM</p>  <p><b>81-20481-30</b>  <b>K</b></p> <p>0415 0392 115x140 A SL LD FPM/ACM</p> 
F 8 L 914	8 Cyl.		<p><b>03-12917-08</b> 0291 1514</p> 					<p><b>71-12917-00</b> 8x 0240 2812</p> 		<p><b>71-25556-10</b>  8x 0414 1486</p>  <p><b>71-20656-30</b>  8x 0336 2170</p> 	<p><b>71-11967-10</b> 0336 9032</p> 	<p><b>81-21395-10</b>  <b>K</b></p> <p>0116 0383 150x172 A LD MVQ</p> 
F 2L 1011 F F 2M 1011	2 Cyl.		<p><b>02-31158-01</b> 0292 9852</p> 	<p><b>08-31414-01</b> 0293 1118</p> 		<p><b>61-29450-30</b> 0417 8861 92,5 Ø 1,5 mm</p> <p><b>61-29450-40</b> 0417 8862 92,5 Ø 1,5 mm</p> <p><b>61-29450-50</b> 0417 8863 92,5 Ø 1,7 mm</p> 	<p><b>14-32252-01</b> 0427 0815 (6X)</p> 	<p><b>71-31158-00</b> 0417 9845</p> 	<p><b>12-27408-06</b> 0415 3728 (4x)</p> <p><b>70-27408-00</b> 0415 3728</p> 	<p><b>71-28323-00</b>  2x 0410 2120</p>  <p><b>71-28380-10</b>  2x 0417 3862</p> 	<p><b>70-31414-10</b></p> 	<p><b>81-20991-10</b>  <b>K</b></p> <p>0413 6133 55x75 AB SL RD ACM</p>  <p><b>81-31440-00</b>  <b>K</b></p> <p>0410 2866 105x125 A SL LD FPM</p>  <p><b>81-21909-20</b> <b>N</b></p> <p>0417 5435 45x60 A SL RD ACM</p> 



















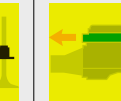

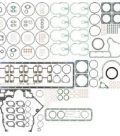
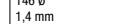
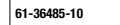

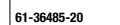











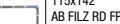



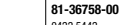









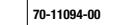





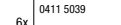

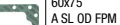











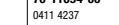

DEUTZ													
BF 3L 1011 FL F 3L 1011 F F 3M 1011 F	3 Cyl. Ltr.	<b>01-31157-01</b> 0292 9853 +0292 9856 +0100 8383 	<b>02-31157-01</b> 0292 9853 	<b>08-31414-01</b> 0293 1118 		<b>61-31560-00</b> 0417 8854 92,5 Ø 1,55 mm <b>1</b> <b>61-31560-10</b> 0417 8855 92,5 Ø 1,6 mm <b>2</b> <b>61-31560-20</b> 0417 8856 92,5 Ø 1,7 mm <b>3</b>	<b>14-32252-02</b> 0427 0815 (8X) 	<b>71-31157-00</b> 0417 9846 	<b>12-27408-03</b> 0415 3728 (6x)  <b>70-27408-00</b> 0415 3728 	<b>71-28323-00</b> 0410 2120  <b>71-28380-10</b> 0417 3862  <b>6x</b>	<b>3x</b>  <b>3x</b> 	<b>70-31414-10</b> 	<b>81-20991-10</b> 0413 6133 55x75 AB SL RD ACM  <b>81-31440-00</b> 0410 2866 105x125 A SL LD FPM  <b>81-21909-20</b> <b>N</b> 0417 5435 45x60 A SL RD ACM 
BF 3M 1011 F	3 Cyl.		<b>02-33592-01</b> 0293 1743 	<b>08-31414-01</b> 0293 1118 		<b>61-31560-00</b> 0417 8854 92,5 Ø 1,55 mm <b>1</b> <b>61-31560-10</b> 0417 8855 92,5 Ø 1,6 mm <b>2</b> <b>61-31560-20</b> 0417 8856 92,5 Ø 1,7 mm <b>3</b>	<b>14-32252-02</b> 0427 0815 (8X) 	<b>71-31157-00</b> 0417 9846 	<b>12-27408-03</b> 0415 3728 (6x)  <b>70-27408-00</b> 0415 3728 	<b>71-28323-00</b> 0410 2120  <b>71-28380-10</b> 0417 3862  <b>6x</b>	<b>3x</b>  <b>3x</b> 	<b>70-31414-10</b> 	<b>81-20991-10</b> 0413 6133 55x75 AB SL RD ACM  <b>81-31440-00</b> 0410 2866 105x125 A SL LD FPM  <b>81-21909-20</b> <b>N</b> 0417 5435 45x60 A SL RD ACM 
BF 4 L 1011	4 Cyl.		<b>02-34855-02</b> 0292 8879 	<b>08-29023-01</b> 0292 8729 		<b>61-34870-00</b> 0417 6101 92,5 Ø 1,48 mm <b>1</b> <b>61-34870-10</b> 0417 6102 92,5 Ø 1,55 mm <b>2</b> <b>61-34870-20</b> 0417 6103 92,5 Ø 1,6 mm <b>3</b>		<b>71-34855-00</b> 0417 3859 	<b>70-27408-00</b> 0415 3728 	<b>8x</b> 	<b>71-28323-00</b> 0410 2120  <b>71-28380-10</b> 0417 3862  <b>4x</b>	<b>70-31414-10</b> 	<b>81-20991-10</b> 0413 6133 55x75 AB SL RD ACM  <b>81-31440-00</b> 0410 2866 105x125 A SL LD FPM 

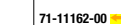
DEUTZ												
BF 4 L 1011 F BF 4L 1011 F BF 4L 1011 FT BF 4M 1011 F	4 Cyl. Ltr.		<p><b>02-31156-02</b> 0292 9855</p> 	<p><b>08-31414-01</b> 0293 1118</p> 		<p><b>61-29455-30</b> 0417 8867 92,5 Ø 1,5 mm</p> <p><b>61-29455-40</b> 0417 8868 92,5 Ø 1,6 mm</p> <p><b>61-29455-50</b> 0417 8869 92,5 Ø 1,7 mm</p> 	<p><b>14-32252-03</b> 0427 0815 (10x)</p> 	<p><b>71-31156-00</b> 0410 2939</p> 	<p><b>70-27408-00</b> 0415 3728</p> 	<p>8x <b>71-28323-00</b>  4x</p> <p>0410 2120</p> <p><b>71-28380-10</b>  4x</p> <p>0417 3862</p>	<p><b>70-31414-10</b></p> 	<p><b>81-20991-10</b>  <b>K</b>↔</p> <p>0413 6133 55x75 AB SL RD ACM</p> <p><b>81-31440-00</b>  <b>K</b>↔</p> <p>0410 2866 105x125 A SL LD FPM</p> <p><b>81-21909-20</b> <b>N</b></p> <p>0417 5435 45x60 A SL RD ACM</p> 
F 4 L 1011	4 Cyl.		<p><b>02-34855-01</b> 0292 8845</p> 	<p><b>08-29023-01</b> 0292 8729</p> 		<p><b>61-34865-00</b> 0417 6120 92,5 Ø 1,55 mm</p> <p><b>61-34865-10</b> 0417 6121 92,5 Ø 1,6 mm</p> <p><b>61-34865-20</b> 0417 6122 92,5 Ø 1,7 mm</p> 		<p><b>71-34855-00</b> 0417 3859</p> 	<p><b>70-27408-00</b> 0415 3728</p> 	<p>8x <b>71-28323-00</b>  4x</p> <p>0410 2120</p> <p><b>71-28380-10</b>  4x</p> <p>0417 3862</p>	<p><b>70-31414-10</b></p> 	<p><b>81-20991-10</b>  <b>K</b>↔</p> <p>0413 6133 55x75 AB SL RD ACM</p> <p><b>81-31440-00</b>  <b>K</b>↔</p> <p>0410 2866 105x125 A SL LD FPM</p> 
F 4L 1011 F F 4L 1011 FL F 4M 1011 F	4 Cyl.		<p><b>02-31156-01</b> 0292 9854</p> 	<p><b>08-31414-01</b> 0293 1118</p> 		<p><b>61-29455-30</b> 0417 8867 92,5 Ø 1,5 mm</p> <p><b>61-29455-40</b> 0417 8868 92,5 Ø 1,6 mm</p> <p><b>61-29455-50</b> 0417 8869 92,5 Ø 1,7 mm</p> 	<p><b>14-32252-03</b> 0427 0815 (10x)</p> 	<p><b>71-31156-00</b> 0410 2939</p> 	<p><b>70-27408-00</b> 0415 3728</p> 	<p>8x <b>71-28323-00</b>  4x</p> <p>0410 2120</p> <p><b>71-28380-10</b>  4x</p> <p>0417 3862</p>	<p><b>70-31414-10</b></p> 	<p><b>81-20991-10</b>  <b>K</b>↔</p> <p>0413 6133 55x75 AB SL RD ACM</p> <p><b>81-31440-00</b>  <b>K</b>↔</p> <p>0410 2866 105x125 A SL LD FPM</p> <p><b>81-21909-20</b> <b>N</b></p> <p>0417 5435 45x60 A SL RD ACM</p> 



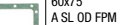



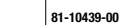





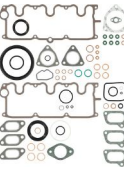
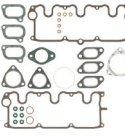

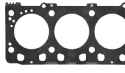

DEUTZ												
<p>BF 4M 1012 BF 4M 1012 C BF 4M 1012 E BF 4M 1012 EC BF 4L 1012 E BF 4L 1012 EC</p>	4 Cyl. Ltr.	<p><b>01-35969-01</b> 0293 1276</p> 				<p><b>61-35865-00</b> 0420 9891 95 Ø 1,5 mm </p> <p><b>61-35865-10</b> 0420 9892 95 Ø 1,6 mm </p> <p><b>61-35865-20</b> 0420 9893 95 Ø 1,7 mm </p> 		<p><b>71-35969-00</b> 0419 8796  09/03</p>  <p><b>71-34871-00</b> 0428 3391  10/03→</p> 		<p><b>71-29078-00</b>  4x 0419 8387</p>  <p><b>71-28747-10</b>  4x 0428 3299</p> 	<p><b>10-35979-01</b> 0420 4452</p> 	<p><b>81-10468-00</b>  0450 2202 74x95 A SL OD FPM</p>  <p><b>81-10370-00</b>  0450 2203 120x140 A SL FPM</p>  <p><b>81-23113-00</b>  120x140 AB SL LD FPM</p> 
<p>BF 6M 1012 BF 6M 1012 C BF 6M 1012 E BF 6M 1012 EC BF 6L 1012 E BF 6L 1012 EC</p>	6 Cyl.	<p><b>01-29317-01</b> 0293 1277</p> 				<p><b>61-35870-00</b> 0420 9895 95 Ø 1,5 mm </p> <p><b>61-35870-10</b> 0420 9896 95 Ø 1,6 mm </p> <p><b>61-35870-20</b> 0420 9897 95 Ø 1,7 mm </p> 		<p><b>71-29317-00</b> 0419 8969</p>  <p><b>71-34869-00</b> 0428 3392</p> 		<p><b>71-29078-00</b>  6x 0419 8387</p>  <p><b>71-28747-10</b>  6x 0428 3299</p> 	<p><b>10-35979-02</b> 0420 4453</p> 	<p><b>81-10468-00</b>  0450 2202 74x95 A SL OD FPM</p>  <p><b>81-10370-00</b>  0450 2203 120x140 A SL FPM</p>  <p><b>81-23113-00</b>  120x140 AB SL LD FPM</p> 
<p>BF 4M 1013 BF 4M 1013 C BF 4M 1013 E BF 4M 1013 EC BF 4M 1013 FC BF 4M 1013 ECW BF 4M 1013 EW</p>	4 Cyl.	<p><b>01-36624-01</b> 0293 1736</p> 				<p><b>61-35875-00</b> 0420 1562 119 Ø 1,5 mm </p> <p><b>61-35875-10</b> 0420 1563 119 Ø 1,6 mm </p> <p><b>61-35875-20</b> 0420 1564 119 Ø 1,7 mm </p> 	<p><b>14-10728-01</b> 0420 2005 (16x)</p> 	<p><b>71-36002-00</b> 0420 5895</p>  <p><b>71-38488-00</b> 0428 4583</p> 		<p><b>71-35044-00</b>  2x 0420 0095</p>  <p><b>71-28747-10</b>  4x 0428 3299</p> 	<p><b>10-35976-01</b> 0420 4458</p> 	<p><b>81-35999-00</b>  0420 2260 81x104 FPM</p>  <p><b>81-10424-00</b>  0490 7773 130x150 A SL LD FPM</p> 

<p><b>DEUTZ</b></p>											
<p>6 Cyl. Ltr.</p> <p>BF 6M 1013 BF 6M 1013 C BF 6M 1013 CP BF 6M 1013 E BF 6M 1013E CP BF 6M 1013 EC BF 6M 1013 FC BF 6M 1013 ECW BF 6M 1013 EW</p>	<p><b>01-36624-02</b> 0293 1737</p> 				<p><b>61-35880-00</b> 0451 4872 119 Ø 1,5 mm</p> <p><b>61-35880-10</b> 0420 1560 119 Ø 1,6 mm</p> <p><b>61-35880-20</b> 0420 1561 119 Ø 1,7 mm</p> 	<p><b>14-10728-02</b> 0420 2005 (26x)</p> 	<p><b>71-29287-00</b> 0420 5894</p>  <p><b>71-37036-00</b> 0428 4008</p> 		<p><b>71-35044-00</b>  3x 0420 0095</p>  <p><b>71-28747-10</b>  6x 0428 3299</p> 	<p><b>10-35976-02</b> 0420 4459</p> 	<p><b>81-35899-00</b>   0420 2260 81x104 FPM</p>  <p><b>81-10424-00</b>   0490 7773 130x150 A SL LD FPM</p> 
<p>6 Cyl.</p> <p>BF 6M 1015 BF 6M 1015 C BF 6M 1015 CP</p>	<p><b>01-33358-01</b></p> 				<p><b>61-36485-00</b> 6x 0426 4004 146 Ø 1,4 mm</p> <p><b>61-36485-10</b> 6x 0426 4005 146 Ø 1,6 mm</p> <p><b>61-36485-20</b> 6x 0426 4006 146 Ø 1,8 mm</p> 	<p><b>71-29380-10</b>   0 6x 0422 4081</p>  <p><b>71-29380-10</b>   0 6x 0422 4392</p>  <p><b>71-33358-00</b>   6x 0422 1064</p> 		<p><b>71-36738-00</b>  6x 0422 0148</p>  <p><b>71-36756-00</b>  6x 0422 3020</p> 	<p><b>71-36627-00</b> 0426 3576</p> 	<p><b>81-36757-00</b>   0422 5441 115x142 AB FILZ RD FPM</p>  <p><b>81-36758-00</b>   0422 5442 115x140 AB FILZ LD FPM</p> 	

DEUTZ												
BF 8M 1015 BF 8M 1015 C BF 8M 1015 CP	8 Cyl. Ltr.	 <b>01-33358-02</b> 0293 1479				 <b>61-36485-00</b> 8x 0426 4004 146 Ø 1,4 mm  <b>61-36485-10</b> 8x 0426 4005 146 Ø 1,6 mm  <b>61-36485-20</b> 8x 0426 4006 146 Ø 1,8 mm 	 <b>71-29380-00</b>  0 8x 0422 4081  <b>71-29380-10</b>  0 8x 0422 4392  <b>71-33358-00</b>  8x 0422 1064	 <b>71-36738-00</b>  8x 0422 0148  <b>71-36756-00</b>  8x 0422 3020	 <b>71-36947-00</b> 0426 3578	 <b>81-36757-00</b>  0422 5441 115x142 AB FILZ RD FPM  <b>81-36758-00</b>  0422 5442 115x140 AB FILZ LD FPM 		
D 2009 L3	3 Cyl.	 <b>01-11091-01</b> 0293 1945			 <b>61-10124-00</b> 0411 5919 MLS 	 <b>14-11168-02</b> 0411 2036 (8x) 	 <b>71-11091-00</b> 0411 8657 	 <b>12-11094-02</b> 0411 4237 (6x)   <b>12-11094-00</b> 0411 4237 	 <b>71-11093-00</b>  0411 5286  <b>71-11231-00</b>  0411 5039 	 <b>71-11092-00</b> 0411 8678 	 <b>81-10440-00</b>  0411 2133 60x75 A SL OD FPM  <b>81-10439-00</b>  0114 8978 70x90 A SL OD FPM 	
D 2009 L4 TD 2009 L4	4 Cyl.	 <b>01-11497-01</b> 0293 1940			 <b>61-10121-00</b> 0411 5918 MLS 	 <b>14-11168-01</b> 0411 2036 (10x) 	 <b>71-11497-00</b> 0411 8658 	 <b>12-11094-01</b> 0411 4237 (8x)   <b>12-11094-00</b> 0411 4237 	 <b>71-11500-00</b>  0411 4135  <b>71-11162-00</b>  0411 4121 	 <b>71-11498-00</b> 0411 8679 	 <b>81-10440-00</b>  0411 2133 60x75 A SL OD FPM  <b>81-10439-00</b>  0114 8978 70x90 A SL OD FPM 	

**DEUTZ**

BF 3L 2011 3 Cyl. Ltr.  
BF 3M 2011

<p><b>01-33592-01</b> 0293 1434</p> 	<p><b>02-33592-01</b> 0293 1743</p> 			<p><b>61-37500-00</b> 0410 3935 1,6 mm 1 ⇒ 01/04</p> <p><b>61-37500-10</b> 0410 3936 1,65 mm 1 ⇒ 01/04</p> <p><b>61-37500-20</b> 0410 3937 1,7 mm 1 ⇒ 01/04</p>  <p><b>61-37520-00</b> 0428 6584 95 Ø 1,48 mm MLS 1 ⇒ 02/04 →</p> <p><b>61-37520-10</b> 0428 6585 95 Ø 1,55 mm MLS 1 ⇒ 02/04 →</p> <p><b>61-37520-20</b> 0428 6586 95 Ø 1,6 mm MLS 1 ⇒ 02/04 →</p> 	<p><b>14-32252-02</b> 0427 0815 (8X)</p> 	<p><b>71-31157-00</b> 0417 9846</p>  <p><b>71-33592-00</b> 0428 0463</p> 	<p><b>12-27408-03</b> 0415 3728 (6x)</p>  <p><b>70-27408-00</b> 0415 3728</p> 	<p><b>71-28323-00</b> 1 ⇒ 3x 0410 2120</p>  <p><b>71-28380-10</b> 1 ⇒ 3x 0417 3862</p> 	<p><b>70-31414-10</b></p> 	<p><b>81-20891-10 K</b> ⇒ 0413 6133 55x75 AB SL RD ACM</p>  <p><b>81-31440-00 K</b> ⇒ 0410 2866 105x125 A SL LD FPM</p>  <p><b>81-21909-20 N</b> 0417 5435 45x60 A SL RD ACM</p> 

DEUTZ

BF 4L 2011  
BF 4M 2011  
F 4L 2011  
F 4M 2011

















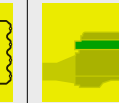
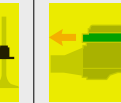
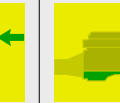

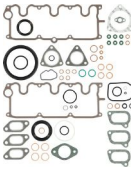
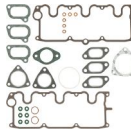

















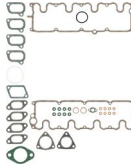



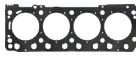



4 Cyl. Ltr.

<p><b>01-31579-01</b> 0293 1435</p>	<p><b>02-31579-01</b> 0293 1741</p>			<p><b>61-37505-00</b> 0428 0816 1,6 mm 1</p> <p><b>61-37505-10</b> 0428 0817 1,65 mm 2</p> <p><b>61-37505-20</b> 0428 0818 1,7 mm 3</p> <p><b>61-37525-00</b> 0428 7425 97 Ø 1,51 mm 1</p> <p><b>61-37525-20</b> 0428 7427 97 Ø 1,56 mm 2</p> <p><b>61-37525-30</b> 0430 0153 97 Ø 1,61 mm 3</p>	<p><b>14-32252-03</b> 0427 0815 (10x)</p>	<p><b>71-31156-00</b> 0410 2939</p> <p><b>71-31579-00</b> 0410 2940</p>	<p><b>12-27408-01</b> 0415 3728 (8x)</p> <p><b>70-27408-00</b> 0415 3728</p>	<p><b>71-28323-00</b> 4x 0410 2120</p> <p><b>71-28380-10</b> 4x 0417 3862</p>	<p><b>70-31414-10</b></p>	<p><b>81-20991-10 K</b> 0413 6133 55x75 AB SL RD ACM</p> <p><b>81-31440-00 K</b> 0410 2866 105x125 A SL LD FPM</p> <p><b>81-21909-20 N</b> 0417 5435 45x60 A SL RD ACM</p>

D 2011 L2  
F 2L 2011  
F 2M 2011  
D 2011 L2 I

2 Cyl.

<p><b>01-31158-01</b> 0293 1433</p>	<p><b>02-31158-02</b> 0293 1742</p>			<p><b>61-37495-00</b> 0428 0808 1,6 mm 1</p> <p><b>61-37495-10</b> 0428 0809 1,65 mm 2</p> <p><b>61-37495-20</b> 0428 0810 1,7 mm 3</p>	<p><b>14-32252-01</b> 0427 0815 (6x)</p>	<p><b>71-31158-00</b> 0417 9845</p>	<p><b>12-27408-06</b> 0415 3728 (4x)</p> <p><b>70-27408-00</b> 0415 3728</p>	<p><b>71-28323-00</b> 2x 0410 2120</p> <p><b>71-28380-10</b> 2x 0417 3862</p>	<p><b>70-31414-10</b></p>	<p><b>81-20991-10 K</b> 0413 6133 55x75 AB SL RD ACM</p> <p><b>81-31440-00 K</b> 0410 2866 105x125 A SL LD FPM</p> <p><b>81-21909-20 N</b> 0417 5435 45x60 A SL RD ACM</p>
---	---	--	--	---	--	---	--	---	---------------------------	--

DEUTZ												
D 2011 L3 F 3L 2011 F 3M 2011 D 2011 L3 I	3 Cyl. Ltr.	<b>01-33592-01</b> 0293 1434 	<b>02-33592-01</b> 0293 1743 			<b>61-37500-00</b> 0410 3935 1,6 mm 1  <b>61-37500-10</b> 0410 3936 1,65 mm 2  <b>61-37500-20</b> 0410 3937 1,7 mm 3  	<b>14-32252-02</b> 0427 0815 (8X) 	<b>71-31157-00</b> 0417 9846 	<b>12-27408-03</b> 0415 3728 (6x)  <b>70-27408-00</b> 0415 3728 	<b>71-28323-00</b>  3x 0410 2120  <b>71-28380-10</b> 3x 0417 3862 	<b>70-31414-10</b> 	<b>81-20991-10</b>  0413 6133 55x75 AB SL RD ACM  <b>81-31440-00</b>  0410 2866 105x125 A SL LD FPM  <b>81-21909-20</b> <b>N</b> 0417 5435 45x60 A SL RD ACM 
D 2011 L4 I D 2011 L4 W	4 Cyl.	<b>01-31579-04</b> 0293 7593 	<b>02-31579-01</b> 0293 1741 			<b>61-38175-00</b> 0410 2011 1,47 mm MLS 1  <b>61-38175-10</b> 0410 2012 1,57 mm MLS 2  <b>61-38175-20</b> 0410 2013 1,67 mm MLS 3  	<b>14-32252-03</b> 0427 0815 (10X) 	<b>71-31156-00</b> 0410 2939  <b>71-31579-00</b> 0410 2940 	<b>12-27408-01</b> 0415 3728 (8x)  <b>70-27408-00</b> 0415 3728 	<b>71-28323-00</b>  4x 0410 2120  <b>71-28380-10</b> 4x 0417 3862 	<b>70-31414-10</b> 	<b>81-20991-10</b>  0413 6133 55x75 AB SL RD ACM  <b>81-31440-00</b>  0410 2866 105x125 A SL LD FPM  <b>81-21909-20</b> <b>N</b> 0417 5435 45x60 A SL RD ACM 



DEUTZ											
TCD 2011 L4 TCD 2011 L4 W	4 Cyl. Ltr.										
TD 2011 L4 W TD 2011 L4 I	4 Cyl.										
BF 4M 2012 BF 4M 2012 C BF 4M 2012 C*	4 Cyl.										

01-31579-02  
0293 7562



02-31579-01  
0293 1741

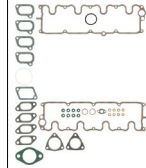

61-38175-00  
0410 2011  
1,47 mm  
MLS



61-38175-10  
0410 2012  
1,57 mm  
MLS

61-38175-20  
0410 2013  
1,67 mm  
MLS

14-32252-03  
0427 0815 (10x)

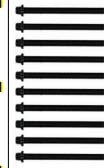

71-31579-00  
0410 2940

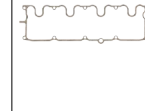

12-27408-01  
0415 3728 (8x)



71-28323-00  
0410 2120



70-31414-10



81-20991-10 K↔  
0413 6133  
55x75  
AB SL RD ACM



81-31440-00 K↔  
0410 2866  
105x125  
A SL LD FPM



81-21909-20 N  
0417 5435  
45x60  
A SL RD ACM



01-31579-03  
0293 7594

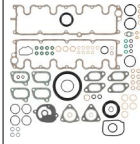

02-31579-01  
0293 1741

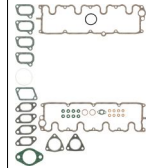

61-38175-00  
0410 2011  
1,47 mm  
MLS



61-38175-10  
0410 2012  
1,57 mm  
MLS

61-38175-20  
0410 2013  
1,67 mm  
MLS

14-32252-03  
0427 0815 (10x)

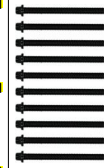

71-31156-00  
0410 2939

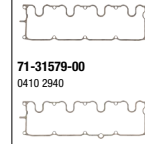

71-31579-00  
0410 2940

12-27408-01  
0415 3728 (8x)

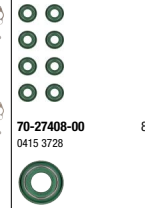

71-28323-00  
0410 2120



70-31414-10



81-20991-10 K↔  
0413 6133  
55x75  
AB SL RD ACM



81-31440-00 K↔  
0410 2866  
105x125  
A SL LD FPM



81-21909-20 N  
0417 5435  
45x60  
A SL RD ACM



01-29061-01  
0293 1738



61-37515-00  
0428 9408  
102 Ø  
1,2 mm  
MLS

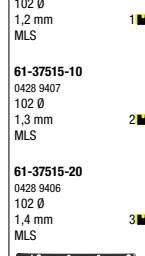

61-37515-10  
0428 9407  
102 Ø  
1,3 mm  
MLS

61-37515-20  
0428 9406  
102 Ø  
1,4 mm  
MLS

71-35969-00  
0419 8796  
1 → 09/03

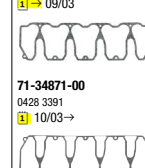

71-34871-00  
0428 3391  
1 → 10/03 →

12-27408-01  
0415 3728 (8x)

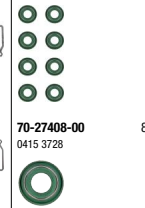

71-34884-00  
0428 3576



10-35979-01  
0420 4452

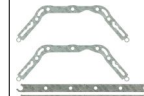















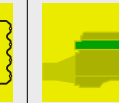
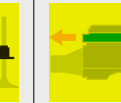
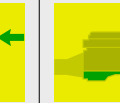

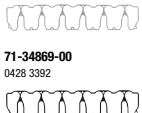
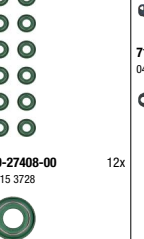
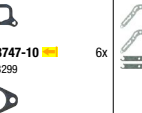
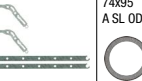
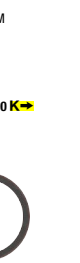







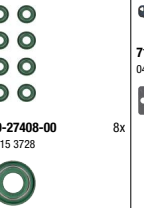















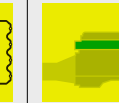
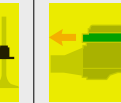
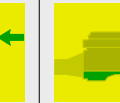























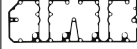

81-10468-00 K↔  
0450 2202  
74x95  
A SL OD FPM





















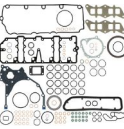









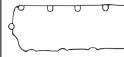











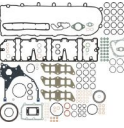







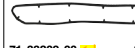





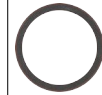









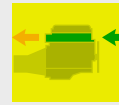













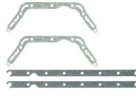

























81-10370-00 K↔  
0450 2203  
120x140  
A SL FPM

















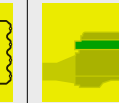
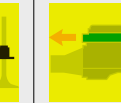
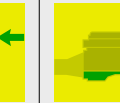

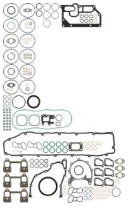

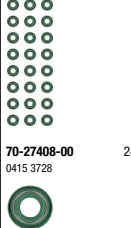







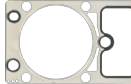
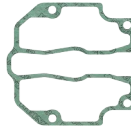







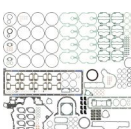
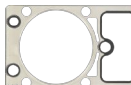
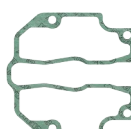
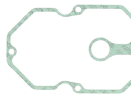















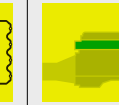
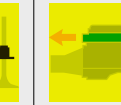
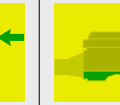

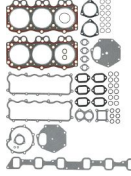
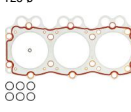





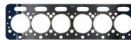

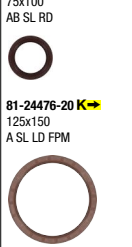
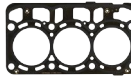
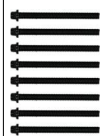

DEUTZ												
BF 6M 2012 C BF 6M 2012 C*	6 Cyl. Ltr.											
		<b>01-29061-02</b> 0293 1739				<b>61-37690-30</b> 0428 9405 99 Ø 1,26 mm MLS 1		<b>71-29317-00</b> 0419 8969  <b>71-34869-00</b> 0428 3392	<b>12-27408-02</b> 0415 3728 12x	<b>71-34884-00</b>  0428 3576  <b>71-28747-10</b>  0428 3299 6x	<b>10-35979-02</b> 0420 4453	<b>81-10468-00</b>  0450 2202 74x95 A SL OD FPM  <b>81-10370-00</b>  0450 2203 120x140 A SL FPM
					<b>61-37690-40</b> 0428 9404 99 Ø 1,36 mm MLS 2							
					<b>61-37690-50</b> 0428 9403 99 Ø 1,46 mm MLS 3							
					 <b>61-37990-00</b> 0428 9411 102 Ø 1,2 mm MLS 1							
					<b>61-37990-10</b> 0428 9410 102 Ø 1,34 mm MLS 2							
					<b>61-37990-20</b> 0428 9409 102 Ø 1,4 mm MLS 3							
												
TCD 2012 L4 2V	4 Cyl.					<b>61-37515-00</b> 0428 9408 102 Ø 1,2 mm MLS 1		<b>71-38977-00</b> 0429 1419  	<b>12-27408-01</b> 0415 3728 (8x)   <b>70-27408-00</b> 0415 3728 8x	<b>71-34884-00</b>  0428 3576  <b>71-38922-00</b>  0429 2820 4x  	<b>10-35979-01</b> 0420 4452	<b>81-10468-00</b>  0450 2202 74x95 A SL OD FPM  <b>81-10370-00</b>  0450 2203 120x140 A SL FPM
					<b>61-37515-10</b> 0428 9407 102 Ø 1,3 mm MLS 2							
					<b>61-37515-20</b> 0428 9406 102 Ø 1,4 mm MLS 3							
												

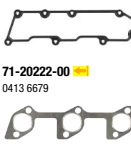



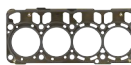
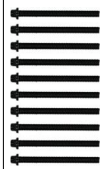

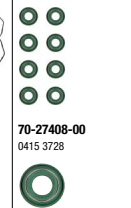
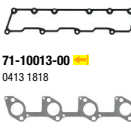

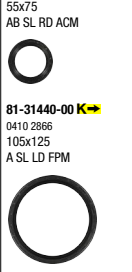







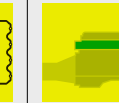
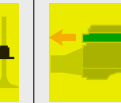
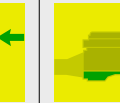



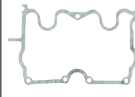













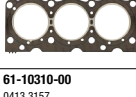











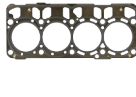
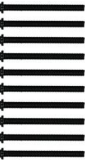

DEUTZ												
TCD 2012 L6 2V	6 Cyl. Ltr.	<b>01-29061-03</b> 0293 1662 				<b>61-37690-30</b> 0428 9405 99 Ø 1,26 mm MLS <b>1</b>  <b>61-37690-40</b> 0428 9404 99 Ø 1,36 mm MLS <b>2</b>  <b>61-37690-50</b> 0428 9403 99 Ø 1,46 mm MLS <b>3</b>    <b>61-37990-00</b> 0428 9411 102 Ø 1,2 mm MLS <b>1</b>  <b>61-37990-10</b> 0428 9410 102 Ø 1,34 mm MLS <b>2</b>  <b>61-37990-20</b> 0428 9409 102 Ø 1,4 mm MLS <b>3</b>  		<b>71-38982-00</b> 0429 1418   <b>71-38982-00</b> 0429 1418 	<b>12-27408-02</b>       <b>70-27408-00</b> 0415 3728 	<b>71-34884-00</b>  6x 0428 3576  <b>71-38922-00</b>  6x 0429 2820 	<b>10-35979-02</b> 0420 4453 	<b>81-10468-00</b>  0450 2202 74x95 A SL OD FPM  <b>81-10370-00</b>  0450 2203 120x140 A SL FPM 
BF 4M 2013	4 Cyl.	<b>01-33352-01</b> 0293 7583 				<b>61-37510-00</b> 0425 9841 1,1 mm <b>1</b>  <b>61-37510-10</b> 0425 9842 1,2 mm <b>2</b>  <b>61-37510-20</b> 0425 9843 1,3 mm <b>3</b>  		<b>71-33352-00</b> 0425 0634  <b>71-33356-00</b> 0425 2217 	<b>70-27408-00</b> 0415 3728 	<b>71-38978-00</b>  16x 0425 2298  <b>71-33209-00</b>  2x 0428 4670 	<b>70-31414-10</b> 	<b>81-10468-00</b>  0450 2202 74x95 A SL OD FPM  <b>81-10370-00</b>  0450 2203 120x140 A SL FPM 

DEUTZ													
BF 4M 2013 C      4 Cyl.      Ltr.	 <p><b>01-33352-01</b> 0293 7583</p>			<p><b>61-10079-00</b> 0425 9959 99 Ø 1,3 mm      2  MLS</p> <p><b>61-10079-10</b> 0425 9962 99 Ø 1,4 mm      3  MLS</p>  <p><b>61-10202-00</b> 0428 2252 102 Ø 1,2 mm      2  MLS</p> <p><b>61-10202-10</b> 0428 2253 102 Ø 1,35 mm      3  MLS</p>  <p><b>61-37510-00</b> 0425 9841 1,1 mm      1 </p> <p><b>61-37510-10</b> 0425 9842 1,2 mm      2 </p> <p><b>61-37510-20</b> 0425 9843 1,3 mm      3 </p> 			<p><b>71-33352-00</b> 0425 0634</p>  <p><b>71-33356-00</b> 0425 2217</p> 		<p><b>70-27408-00</b>      16x 0415 3728</p> 		<p><b>71-38978-00</b>       1x 0425 2298</p>  <p><b>71-33209-00</b>       2x 0428 4670</p> 	<p><b>70-31414-10</b></p> 	<p><b>81-10468-00</b>  0450 2202 74x95 A SL OD FPM</p>  <p><b>81-10370-00</b>  0450 2203 120x140 A SL FPM</p> 
BF 6M 2013      6 Cyl. BF 6M 2013 C	 <p><b>01-33083-01</b> 0293 1312</p>				<p><b>61-37530-00</b> 0428 5624 99 Ø 1,16 mm      1  MLS</p> <p><b>61-37530-10</b> 0428 5625 99 Ø 1,26 mm      2  MLS</p> <p><b>61-37530-20</b> 0428 5626 99 Ø 1,36 mm      3  MLS</p> 		<p><b>71-33017-00</b> 0425 2218</p>  <p><b>71-33083-00</b> 0425 0612</p> 	<p><b>70-27408-00</b>      24x 0415 3728</p> 	<p><b>71-38979-00</b>       1x 0425 2299</p>  <p><b>71-33209-00</b>       3x 0428 4670</p> 	<p><b>70-31414-10</b></p> 	<p><b>81-10468-00</b>  0450 2202 74x95 A SL OD FPM</p>  <p><b>81-10370-00</b>  0450 2203 120x140 A SL FPM</p> 		



















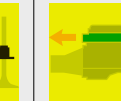









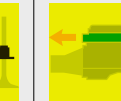







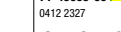
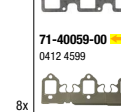
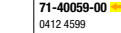

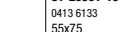

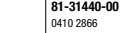

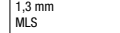

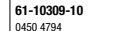

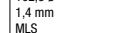

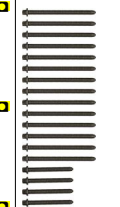
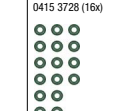

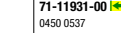

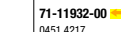

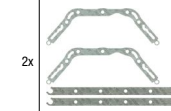
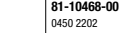

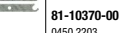

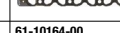
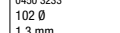
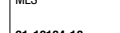
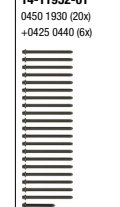
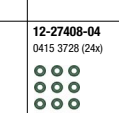

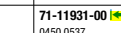

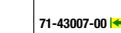
DEUTZ												
TCD 2013 L4 2V	4 Cyl. Ltr.	<p><b>01-38974-01</b> 0293 1763</p> 				<p><b>61-43165-00</b> 0429 2652 1,53 mm MLS <b>2</b> </p> <p><b>61-43165-10</b> 0429 2653 1,63 mm MLS <b>3</b> </p>  	<p><b>14-10728-01</b> 0420 2005 (18x)</p> 	<p><b>71-38974-00</b> 0429 1468</p> 		<p><b>71-35044-00</b>  <b>2x</b></p> <p>0420 0095</p>  <p><b>71-38922-00</b>  <b>4x</b></p> <p>0429 2820</p> 	<p><b>10-35976-01</b> 0420 4458</p> 	<p><b>81-35999-00</b>  <b>K</b></p> <p>0420 2260 81x104 FPM</p>  <p><b>81-10424-00</b>  <b>K</b></p> <p>0490 7773 130x150 A SL LD FPM</p> 
TCD 2013 L4 4V	4 Cyl.	<p><b>01-37698-01</b> 0293 7643</p> 				<p><b>61-36835-00</b> 0490 2563 1,15 mm <b>1</b> </p> <p><b>61-36835-10</b> 0490 2562 1,25 mm <b>2</b> </p> 		<p><b>71-37698-00</b></p> 	<p><b>70-27408-00</b> <b>16x</b></p> <p>0415 3728</p> 	<p><b>71-37842-00</b>  <b>4x</b></p> <p>0490 0310</p>  <p><b>71-36731-00</b>  <b>2x</b></p> <p>0490 4705</p> 	<p><b>70-31414-10</b></p> 	<p><b>81-35999-00</b>  <b>K</b></p> <p>0420 2260 81x104 FPM</p>  <p><b>81-10424-00</b>  <b>K</b></p> <p>0490 7773 130x150 A SL LD FPM</p> 
TCD 2013 L6 2V	6 Cyl.	<p><b>01-38971-01</b> 0293 1663</p> 				<p><b>61-37570-00</b> 0429 4194 1,42 mm <b>1</b> </p> <p><b>61-37570-10</b> 0429 4195 1,52 mm <b>2</b> </p> <p><b>61-37570-20</b> 0429 4196 1,62 mm <b>3</b> </p> 	<p><b>14-10728-02</b> 0420 2005 (26x)</p> 	<p><b>71-38971-00</b> 0428 8910</p> 	<p><b>12-76945-02</b> 0115 3857 (12x)</p> 	<p><b>71-35044-00</b>  <b>3x</b></p> <p>0420 0095</p>  <p><b>71-38922-00</b>  <b>6x</b></p> <p>0429 2820</p> 	<p><b>10-35976-02</b> 0420 4459</p> 	<p><b>81-35999-00</b>  <b>K</b></p> <p>0420 2260 81x104 FPM</p>  <p><b>81-10424-00</b>  <b>K</b></p> <p>0490 7773 130x150 A SL LD FPM</p> 



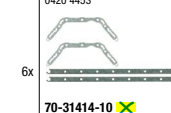

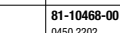

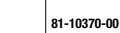









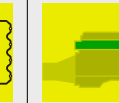
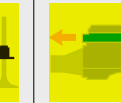
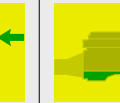

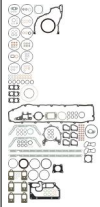



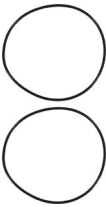





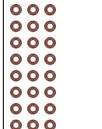











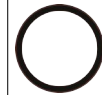

DEUTZ												
TCD 2013 L6 4V	6 Cyl. Ltr.	<p><b>01-39468-01</b> 0293 7644</p>  <p><b>01-39468-06</b> 0293 1797</p> 				<p><b>61-36840-00</b> 0490 0688 109,5 Ø 1,15 mm <b>1</b></p> <p><b>61-36840-10</b> 0490 0689 109,5 Ø 1,25 mm <b>2</b></p> 		<p><b>71-39468-00</b> 0415 1626</p> 	<p><b>12-27408-04</b> 0415 3728 (24x)</p>  <p><b>70-27408-00</b> 0415 3728</p> 	<p><b>71-37842-00</b> <b>1</b> <b>3x</b> 0490 0310</p>  <p><b>71-36731-00</b> <b>3x</b> 0490 4705</p> 	<p><b>70-31414-10</b></p> 	<p><b>81-35899-00</b> <b>K</b> 0420 2260 81x104 FPM</p>  <p><b>81-10424-00</b> <b>K</b> 0490 7773 130x150 A SL LD FPM</p> 
TCD 2015 V6	6 Cyl.	<p><b>01-33358-06</b> 0293 1719</p> 			<p><b>61-36485-00</b> 6x 0426 4004 146 Ø 1,4 mm <b>1</b></p> <p><b>61-36485-10</b> 6x 0426 4005 146 Ø 1,6 mm <b>2</b></p> <p><b>61-36485-20</b> 6x 0426 4006 146 Ø 1,8 mm <b>3</b></p> 		<p><b>71-29380-10</b> <b>0</b> 6x 0422 4392</p>  <p><b>71-33358-00</b> <b>U</b> 6x 0422 1064</p> 	<p><b>70-27408-00</b> 24x 0415 3728</p> 	<p><b>71-36738-00</b> <b>1</b> <b>6x</b> 0422 0148</p>  <p><b>71-36756-00</b> <b>6x</b> 0422 3020</p> 	<p><b>71-36627-00</b> 0426 3576</p> 	<p><b>81-36757-00</b> <b>K</b> 0422 5441 115x142 AB FILZ RD FPM</p>  <p><b>81-36758-00</b> <b>K</b> 0422 5442 115x140 AB FILZ LD FPM</p> 	
TCD 2015 V8	8 Cyl.	<p><b>01-33358-05</b> 0293 1720</p> 			<p><b>61-36485-00</b> 8x 0426 4004 146 Ø 1,4 mm <b>1</b></p> <p><b>61-36485-10</b> 8x 0426 4005 146 Ø 1,6 mm <b>2</b></p> <p><b>61-36485-20</b> 8x 0426 4006 146 Ø 1,8 mm <b>3</b></p> 		<p><b>71-29380-10</b> <b>0</b> 8x 0422 4392</p>  <p><b>71-33358-00</b> <b>U</b> 8x 0422 1064</p> 	<p><b>70-27408-00</b> 32x 0415 3728</p> 	<p><b>71-36738-00</b> <b>1</b> <b>8x</b> 0422 0148</p>  <p><b>71-36756-00</b> <b>8x</b> 0422 3020</p> 	<p><b>71-36947-00</b> 0426 3578</p> 	<p><b>81-36757-00</b> <b>K</b> 0422 5441 115x142 AB FILZ RD FPM</p>  <p><b>81-36758-00</b> <b>K</b> 0422 5442 115x140 AB FILZ LD FPM</p> 	

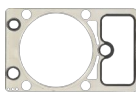







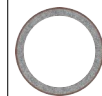







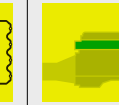
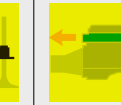
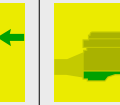

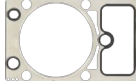







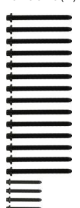

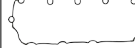

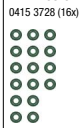





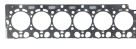
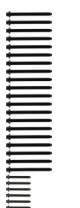

DEUTZ												
8220.02.842	6 Cyl. Ltr.	 01-33975-02	 02-33975-02			 61-33975-00 2x 128 Ø		 71-82905-00 2x		 71-33926-00 6x 71-82742-00 6x	 71-33979-00 71-33984-10	 81-23112-30 K 105x130 AB FIL RD PTFE ACM
8360.05.670	6 Cyl.	 01-33990-02	 02-33990-02			 61-33990-00 117,5 Ø 2,1 mm		 71-82903-00 2x		 71-45183-00 4x 71-84120-10 2x 71-45193-00 3x	 71-83011-00	 81-10122-00 K 75x100 AB SL RD  81-24476-20 K 125x150 A SL LD FPM
D 2.2 L3 TCD 2.2 L3 TD 2.2 L3	3 Cyl.					 61-11082-00 0413 6139 93 Ø 1,5 mm MLS	 14-32252-02 0427 0815 (8x)	 71-20220-00 0413 6181	 12-10719-02 0066 1771 (6x)  70-10719-00 0066 1771	 71-13161-00 6x 0413 6628  71-20222-00 6x 0413 6679	 70-31414-10	 81-20991-10 K 0413 6133 55x75 AB SL RD ACM  81-31440-00 K 0410 2866 105x125 A SL LD FPM
D 2.9 L4 TD 2.9 L4	4 Cyl.	 01-10310-01 0293 7719				 61-10310-00 0413 3157 93 Ø 1,4 mm MLS	 14-32252-03 0427 0815 (10x)	 71-12057-00 0413 3138	 12-27408-01 0415 3728 (8x)  70-27408-00 0415 3728	 71-12049-00 8x 0412 5801  71-10013-00 8x 0413 1818	 70-31414-10	 81-20991-10 K 0413 6133 55x75 AB SL RD ACM  81-31440-00 K 0410 2866 105x125 A SL LD FPM



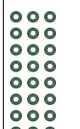















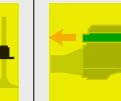

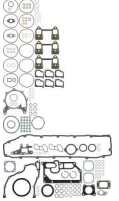
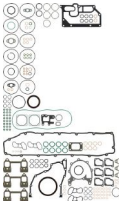

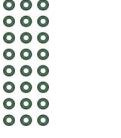







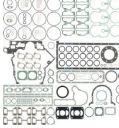
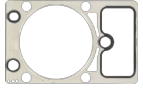
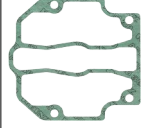





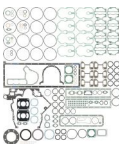

DEUTZ												
F 2L 1011	2 Cyl. Ltr.		<p><b>02-34845-01</b> 0292 8843</p> 	<p><b>08-29023-01</b> 0292 8729</p> 		<p><b>61-34860-00</b> 0417 6117 92,5 Ø 1,55 mm 1</p> <p><b>61-34860-10</b> 0417 6118 92,5 Ø 1,6 mm 2</p> <p><b>61-34860-20</b> 0417 6119 92,5 Ø 1,7 mm 3</p> 		<p><b>71-34845-00</b> 0417 3857</p> 	<p><b>12-27408-06</b> 0415 3728 (4x)</p> <p><b>70-27408-00</b> 0415 3728 4x</p> 	<p><b>71-28323-00</b>  2x 0410 2120</p> <p><b>71-28380-10</b>  2x 0417 3862</p>  	<p><b>70-31414-10</b></p> 	<p><b>81-20991-10</b>  0413 6133 55x75 AB SL RD ACM</p>  <p><b>81-31440-00</b>  0410 2866 105x125 A SL LD FPM</p>  <p><b>81-21909-20</b> <b>N</b> 0417 5435 45x60 A SL RD ACM</p> 
F 3L 1011	3 Cyl.		<p><b>02-34850-01</b> 0292 8844</p> 	<p><b>08-29023-01</b> 0292 8729</p> 		<p><b>61-29180-00</b> 0417 6489 92,5 Ø 1,55 mm 1</p> <p><b>61-29180-10</b> 0417 6490 92,5 Ø 1,6 mm 2</p> <p><b>61-29180-20</b> 0417 6491 92,5 Ø 1,7 mm 3</p> 		<p><b>71-34850-00</b> 0417 3858</p> 	<p><b>12-27408-03</b> 0415 3728 (6x)</p> <p><b>70-27408-00</b> 0415 3728 6x</p> 	<p><b>71-28323-00</b>  3x 0410 2120</p> <p><b>71-28380-10</b>  3x 0417 3862</p>  	<p><b>70-31414-10</b></p> 	<p><b>81-20991-10</b>  0413 6133 55x75 AB SL RD ACM</p>  <p><b>81-31440-00</b>  0410 2866 105x125 A SL LD FPM</p> 
TCD 2.9 L4 TCD 2.9 L4 HP TCD 2.9 L4 HT	4 Cyl.	<p><b>01-10310-01</b> 0293 7719</p> 			<p><b>61-10310-00</b> 0413 3157 93 Ø 1,4 mm MLS</p> 	<p><b>14-32252-03</b> 0427 0815 (10x)</p> 		<p><b>12-27408-01</b> 0415 3728 (8x)</p> <p><b>70-27408-00</b> 0415 3728 8x</p>  	<p><b>71-12049-00</b>  1 0412 5801</p> <p><b>71-10013-00</b>  0413 1818</p>  	<p><b>70-31414-10</b></p> 	<p><b>81-20991-10</b>  0413 6133 55x75 AB SL RD ACM</p>  <p><b>81-31440-00</b>  0410 2866 105x125 A SL LD FPM</p> 	

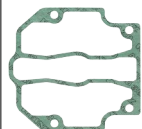

DEUTZ												
TCD 3.6 L4 TCD 3.6 L4 HP TCD 3.6 L4 HT TCD 3.6 L04 Tier 4i TD 3.6 L4	4 Cyl. Ltr.											
		<b>01-10077-01</b> 0293 7754 				<b>61-10077-00</b> 0412 5491 MLS 	<b>14-10669-03</b> 0425 0441 (16x) 	<b>71-10671-00</b> 0412 3406 	<b>12-27408-01</b> 0415 3728 (8x) 	<b>71-40099-00</b>  0412 2327  <b>71-40059-00</b>  0412 4599  8x	<b>70-31414-10</b> 	<b>81-20891-10</b>  0413 6133 55x75 AB SL RD ACM  <b>81-31440-00</b>  0410 2866 105x125 A SL LD FPM 
TCD 4.1 L04 4V	4 Cyl.					<b>61-10309-00</b> 0450 4793 102,3 Ø 1,3 mm MLS  1  <b>61-10309-10</b> 0450 4794 102,3 Ø 1,4 mm MLS  2  <b>61-10309-20</b> 0450 4795 102,3 Ø 1,5 mm MLS  3 	<b>14-11952-03</b> 0450 1930 (14x) +0425 1251 (4x) 		<b>12-27408-07</b> 0415 3728 (16x)  <b>70-27408-00</b> 0415 3728  16x	<b>71-11931-00</b>  4x 0450 0537  <b>71-11932-00</b>  2x 0451 4217 	<b>10-35979-01</b> 0420 4452 	<b>81-10468-00</b>  0450 2202 74x95 A SL OD FPM  <b>81-10370-00</b>  0450 2203 120x140 A SL FPM 
TCD 6.1 L06 4V	6 Cyl.					<b>61-10164-00</b> 0450 3233 102 Ø 1,3 mm MLS  <b>61-10164-10</b> 0451 2439 102 Ø 1,4 mm MLS  <b>61-10164-20</b> 0451 2440 102 Ø 1,5 mm MLS 	<b>14-11952-01</b> 0450 1930 (20x) +0425 0440 (6x) 		<b>12-27408-04</b> 0415 3728 (24x)  <b>70-27408-00</b> 0415 3728  24x	<b>71-11931-00</b>  6x 0450 0537  <b>71-43007-00</b>  6x 0451 3865  <b>71-11932-00</b>  3x 0451 4217 	<b>10-35979-02</b> 0420 4453  <b>70-31414-10</b> 	<b>81-10468-00</b>  0450 2202 74x95 A SL OD FPM  <b>81-10370-00</b>  0450 2203 120x140 A SL FPM 





















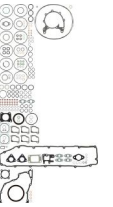

DEUTZ												
TCD 7.8 L6	6 Cyl. Ltr.	<p><b>01-39468-02</b> 0293 7848</p>  <p><b>01-39468-03</b> 0293 7871</p>  <p><b>01-39468-04</b> 0293 7849</p> 			<p><b>15-73194-01</b>  6x 0118 1178 (2x)</p> 	<p><b>61-10085-00</b> 0490 7243 112 Ø 1,15 mm </p> <p><b>61-10085-10</b> 0490 7244 112 Ø 1,25 mm </p> 	<p><b>14-10726-01</b> 0490 0634 (20x) +0490 0633 (6x)</p> 	<p><b>71-39468-00</b> 0490 1626</p> 	<p><b>12-10719-01</b> 0066 1771 (24x)</p>  <p><b>70-10719-00</b> 0066 1771</p> 	<p><b>71-37842-00</b>  6x 0490 0310</p>  <p><b>71-39926-00</b>  3x 0491 1100</p> 	<p><b>10-35976-02</b> 0420 4459</p> 	<p><b>81-10423-00</b>   0490 7772 81x104 A SL FPM</p>  <p><b>81-10424-00</b>   0490 7773 130x150 A SL LD FPM</p> 
TCD 12.0-V6	6 Cyl.				<p><b>61-36485-00</b> 0426 4004 146 Ø 1,4 mm </p> <p><b>61-36485-10</b> 0426 4005 146 Ø 1,6 mm </p> <p><b>61-36485-20</b> 0426 4006 146 Ø 1,8 mm </p> 				<p><b>71-36756-00</b>  6x 0422 3020</p> 	<p><b>71-36627-00</b> 0426 3576</p> 	<p><b>81-36757-00</b>   0422 5441 115x142 AB FILZ RD FPM</p>  <p><b>81-36758-00</b>   0422 5442 115x140 AB FILZ LD FPM</p> 	

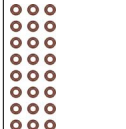
DEUTZ												
TCD 16.0-V6	8 Cyl. Ltr.					<p><b>61-36485-00</b> 0426 4004 146 Ø 1,4 mm <b>1</b></p> <p><b>61-36485-10</b> 0426 4005 146 Ø 1,6 mm <b>2</b></p> <p><b>61-36485-20</b> 0426 4006 146 Ø 1,8 mm <b>3</b></p> 				<p><b>71-36756-00</b>  <b>8x</b> 0422 3020</p> 	<p><b>71-36947-00</b> 0426 3578</p> 	<p><b>81-36757-00 K↔</b> 0422 5441 115x142 AB FILZ RD FPM</p>  <p><b>81-36758-00 K↔</b> 0422 5442 115x140 AB FILZ LD FPM</p> 
TCD 2012 L4 4V	4 Cyl.	<p><b>01-33352-02</b> 0293 7589</p> 				<p><b>61-10078-00</b> 0451 1447 102 Ø 1,3 mm MLS <b>2</b></p> <p><b>61-10078-10</b> 0451 1448 102 Ø 1,4 mm MLS <b>3</b></p> 	<p><b>14-10669-02</b> 0425 0441 (14x) +0425 0440 (4x)</p> 	<p><b>71-33352-00</b>  0425 0634</p>  <p><b>71-33356-00</b>  0425 2217</p> 	<p><b>12-27408-07</b> 0415 3728 (16x)</p>  <p><b>70-27408-00</b> 0415 3728</p> 	<p><b>71-10090-00</b>  <b>2x</b> 0429 2563</p> 	<p><b>70-31414-10</b></p> 	<p><b>81-10468-00 K↔</b> 0450 2202 74x95 A SL OD FPM</p>  <p><b>81-10370-00 K↔</b> 0450 2203 120x140 A SL FPM</p> 
TCD 2012 L06 4V DCR	6 Cyl.	<p><b>01-33083-02</b> 0293 7590</p> 				<p><b>61-10008-00</b> 0429 3262 102 Ø 1,2 mm MLS <b>1</b></p> <p><b>61-10008-10</b> 0429 3263 102 Ø 1,3 mm MLS <b>2</b></p> <p><b>61-10008-20</b> 0429 3331 102 Ø 1,4 mm MLS <b>3</b></p> 	<p><b>14-10669-01</b> 0425 0441 (20x) +0425 0440 (6x)</p> 	<p><b>71-33017-00</b>  0425 2218</p>  <p><b>71-33083-00</b>  0425 0612</p> 	<p><b>12-27408-04</b> 0415 3728 (24x)</p>  <p><b>70-27408-00</b> 0415 3728</p> 	<p><b>71-10090-00</b>  <b>3x</b> 0429 2563</p> 	<p><b>70-31414-10</b></p> 	<p><b>81-10468-00 K↔</b> 0450 2202 74x95 A SL OD FPM</p>  <p><b>81-10370-00 K↔</b> 0450 2203 120x140 A SL FPM</p> 

DEUTZ												
TCD 2013 L06 4V	6 Cyl. Ltr.	<p><b>01-39468-01</b> 0293 7644</p>  <p><b>01-39468-06</b> 0293 1797</p> 				<p><b>61-36840-00</b> 0490 0688 109,5 Ø 1,15 mm <b>1</b></p> <p><b>61-36840-10</b> 0490 0689 109,5 Ø 1,25 mm <b>2</b></p> 		<p><b>71-39468-00</b> 0490 1626</p> 	<p><b>12-27408-04</b> 0415 3728 (24x)</p>  <p><b>70-27408-00</b> 0415 3728</p> 	<p><b>71-37842-00</b> <b>K</b> <b>3x</b> 0490 0310</p>  <p><b>71-36731-00</b> <b>3x</b> 0490 4705</p> 	<p><b>70-31414-10</b></p> 	<p><b>81-10423-00</b> <b>K</b> 0490 7772 81x104 A SL FPM</p>  <p><b>81-35999-00</b> <b>K</b> 0420 2260 81x104 FPM</p>  <p><b>81-10424-00</b> <b>K</b> 0490 7773 130x150 A SL LD FPM</p> 
TCG 2015 V6	6 Cyl.	<p><b>01-33358-03</b> 0293 1717</p> 			<p><b>61-36485-00</b> 6x 0426 4004 146 Ø 1,4 mm <b>1</b></p> <p><b>61-36485-10</b> 6x 0426 4005 146 Ø 1,6 mm <b>2</b></p> <p><b>61-36485-20</b> 6x 0426 4006 146 Ø 1,8 mm <b>3</b></p> 		<p><b>71-29380-10</b> <b>0</b> 6x 0422 4392</p>  <p><b>71-33358-00</b> <b>U</b> 6x 0422 1064</p> 	<p><b>12-27408-06</b> 6x 0415 3728 (4x)</p>  <p><b>70-27408-00</b> 24x 0415 3728</p> 	<p><b>71-36738-00</b> <b>K</b> 6x 0422 0148</p>  <p><b>71-38923-00</b> <b>0</b> 6x 0422 8309</p> 	<p><b>71-36627-00</b> 0426 3576</p> 	<p><b>81-36757-00</b> <b>K</b> 0422 5441 115x142 AB FILZ RD FPM</p>  <p><b>81-36758-00</b> <b>K</b> 0422 5442 115x140 AB FILZ LD FPM</p> 	
TCG 2015 V8	8 Cyl.	<p><b>01-33358-04</b> 0293 1718</p> 			<p><b>61-36485-00</b> 8x 0426 4004 146 Ø 1,4 mm <b>1</b></p> <p><b>61-36485-10</b> 8x 0426 4005 146 Ø 1,6 mm <b>2</b></p> <p><b>61-36485-20</b> 8x 0426 4006 146 Ø 1,8 mm <b>3</b></p> 		<p><b>71-29380-10</b> <b>0</b> 8x 0422 4392</p>  <p><b>71-33358-00</b> <b>U</b> 8x 0422 1064</p> 	<p><b>12-27408-06</b> 8x 0415 3728 (4x)</p>  <p><b>70-27408-00</b> 32x 0415 3728</p> 	<p><b>71-36738-00</b> <b>K</b> 8x 0422 0148</p>  <p><b>71-38923-00</b> <b>0</b> 8x 0422 8309</p> 	<p><b>71-36947-00</b> 0426 3578</p> 	<p><b>81-36757-00</b> <b>K</b> 0422 5441 115x142 AB FILZ RD FPM</p>  <p><b>81-36758-00</b> <b>K</b> 0422 5442 115x140 AB FILZ LD FPM</p> 	

**DEUTZ**

TTCD 7.8 L6 6 Cyl. Ltr.

										
<p><b>01-39468-05</b> 0293 7872</p> 				<p><b>61-10308-00</b> 0491 4706 112 Ø 1,15 mm</p> <p><b>61-10308-10</b> 0491 4707 112 Ø 1,25 mm</p> 	<p><b>14-10726-01</b> 0490 0634 (20x) +0490 0633 (6x)</p> 	<p><b>71-39468-00</b> 0490 1626</p> 	<p><b>12-10719-01</b> 0066 1771 (24x)</p>  <p><b>70-10719-00</b> 0066 1771</p> 	<p><b>71-13396-00</b> 6x 0460 2340</p>  <p><b>71-39926-00</b> 3x 0491 1100</p> 	<p><b>10-10302-01</b> 0490 5028 +0118 0346</p>  <p><b>70-31414-10</b></p> 	<p><b>81-10423-00 K</b> 0490 7772 81x104 A SL FPM</p>  <p><b>81-10424-00 K</b> 0490 7773 130x150 A SL LD FPM</p> 

# Haftungsausschluss

## (für Katalog)

**Alle Angaben in unserem Katalog** wurden von uns sorgfältig geprüft, sind jedoch unverbindlich. Ersatzansprüche wegen Katalogangaben werden von uns nicht anerkannt. Der Käufer ist selbst verpflichtet, zu prüfen, ob unsere Teile für seine Zwecke geeignet sind. In allen Zweifelsfällen sollte Rücksprache mit unserem technischen Kundendienst erfolgen **Tel. +49 731 7046 999**.

**Technische Weiterentwicklungen** oder Änderungen bleiben vorbehalten, soweit damit keine Nachteile für den Kunden verbunden sind.

**Angaben, Namens- und Markenzeichen**, Beschreibungen, Nummern von Fahrzeugnummern und Herstellerzeichen, Original-Ersatzteilnummern der Fahrzeug- und Motorenhersteller u. a. sind ausschließlich für interne Zwecke gedacht. Solche Kennzeichnungen dürfen Fahrzeugbesitzern gegenüber nicht verwendet werden.

**Wir weisen ausdrücklich darauf hin**, dass alle von uns gelieferten Teile von geschultem Fachpersonal einzubauen sind. Reinz haftet für Fehler in diesem Katalog nur, wenn diese für den Kunden nicht offenbar erkennbar sind sowie nur bei Vorsatz und grober Fahrlässigkeit von Reinz, eines Vertreters oder eines Erfüllungsgehilfen. Dieser Haftungsausschluss gilt nicht im Rahmen

des Anwendungsbereichs des Produkthaftungsgesetzes und nicht bei Verletzung von Körper, Leben und Gesundheit, sowie bei der Verletzung von sog. Kardinalpflichten. Darüber hinaus ist unsere Haftung für Schäden, insbesondere für Personen-, Sach- oder Vermögensschäden, die unmittelbar oder mittelbar im Zusammenhang mit der Nutzung dieses Kataloges auftreten, sowie für nicht voraussehbare Schäden ausgeschlossen.

**Reinz ist Inhaber aller Schutzrechte** an den in diesem Katalog gespeicherten Daten. Kopie, Nachdruck, ganze oder teilweise Übernahme der Inhalte und Vervielfältigung, auch auszugsweise, ist nur mit unserer vorheriger schriftlicher Zustimmung sowie mit unserem Urheberrechtsvermerk zulässig.

Für Bestellungen, welche ab dem Erscheinungsdatum eines neuen Katalogs getätigt werden, sind alleine die Angaben des neuen Katalogs maßgeblich. Auf Angaben im Vorkatalog kann bei Neubestellungen nicht mehr zurückgegriffen werden.

**Sofern Sie noch Fragen haben, bitten wir Sie, sich mit uns in Verbindung zu setzen.**

VictorReinz.com/AGB

# Exclusion of Liability

## (for catalog)

**All details in our catalog** have been thoroughly checked by us but are however not binding. Right to damages on account of catalog details will not be recognized. The purchaser is obliged to check if our parts are suitable for their use. In all doubtful cases, the purchaser should consult our technical customer service under **+49 731 7046 999**.

**We reserve the right** to further technical developments or changes as long as no disadvantage for the customer results.

**Details, name and trademarks**, descriptions, numbers from vehicle numbers and manufacturer symbols, original vehicle replacement part numbers and engine manufacturer etc. are solely for internal use. Such labels must not be used with vehicle owners.

**We specifically point out** that all parts supplied by us must be assembled by trained specialists.

**Reinz is liable for mistakes** in this catalog only when they are not clearly recognizable for the customer, as well as by intent or gross negligence on the part of Reinz, its representative or vicarious agent. This exclusion of liability does not apply within the framework of the field of

application of the product liability laws and not by bodily harm, life and health, as well as by violation of cardinal duties. In addition, our liability for damages, especially personal, property or financial damages that occur directly or indirectly as a result of the use of this catalog, as well as non-foreseeable damages are excluded.

**Reinz is the owner of all patent rights** on the data stored in this catalog. Copies, reprints, whole or partial takeover of the contents and duplication even in excerpts are only permissible with our prior written approval, as well as with our copyright note.

**For orders placed after the publication date** of a new catalog, only the details in the new catalog are binding and no fall back to details in the previous catalog is possible.

**In case you have further questions, do not hesitate to contact us.**

VictorReinz.com/AGB

**VictorReinz.com**

**reinz.info@dana.com**

**Technical Hotline +49 (0)731 7046-9 99**

**REINZ-Dichtungs-GmbH**

Reinzstrasse 3-7  
89233 Neu-Ulm  
Germany  
+49 (0)731 7046-0

***VICTOR REINZ***<sup>®</sup>

---

