

VICTOR REINZ®

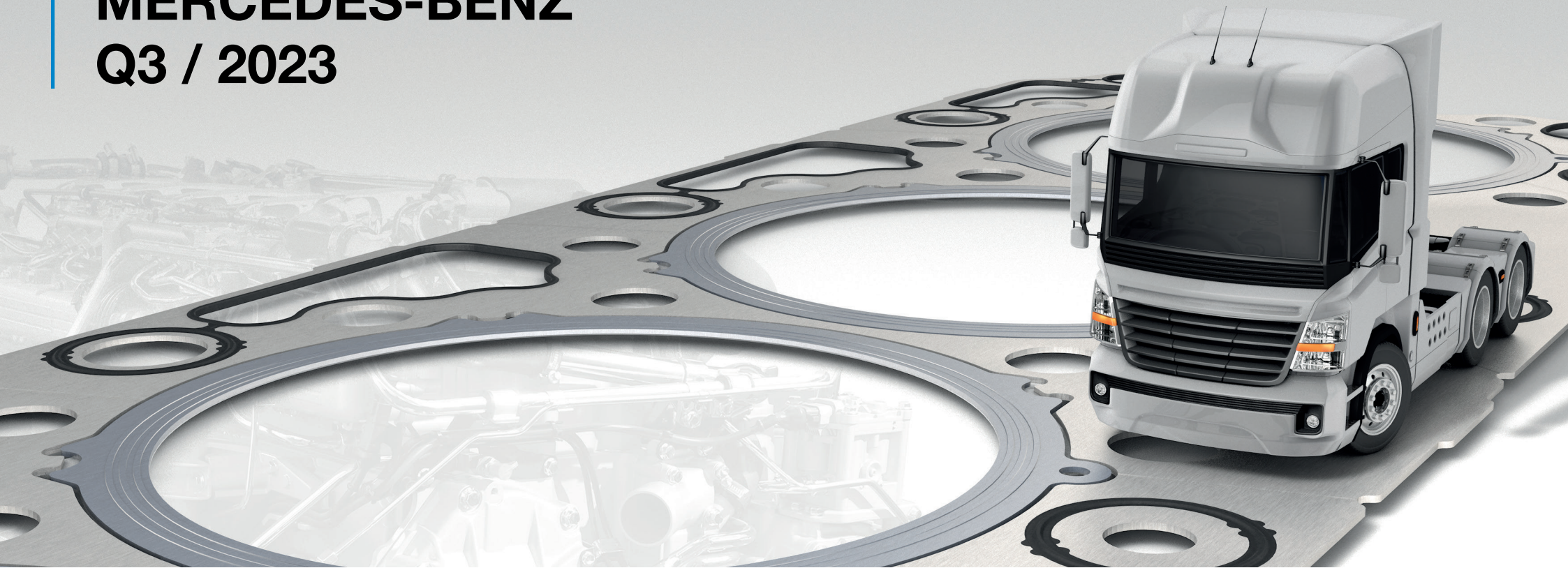

MERCEDES-BENZ
Q3 / 2023



VictorReinz.com/online-catalog

Victor Reinz®

at a Glance



Online Catalog

VictorReinz.com/online-catalog



Newsletter

VictorReinz.com/EN/News/Newsletter.aspx?region



Youtube

www.youtube.com/user/VictorReinzSealingEN



Catalog News

VictorReinz.com/news



Technical Service Information

VictorReinz.com/tsi



Facebook

www.facebook.com/VictorReinzParts



Just seal it!

VictorReinz.com/jsi



Technical Datasheet

VictorReinz.com/jsi-datasheet



LinkedIn

www.linkedin.com/showcase/victor-reinz-emea



Safety Datasheet

VictorReinz.com/jsi-datasheet



Homepage

VictorReinz.com

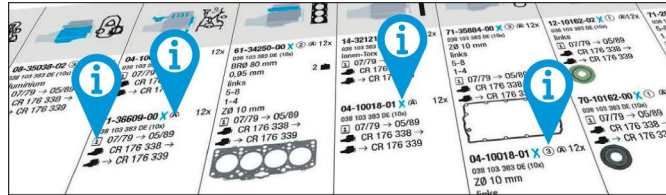



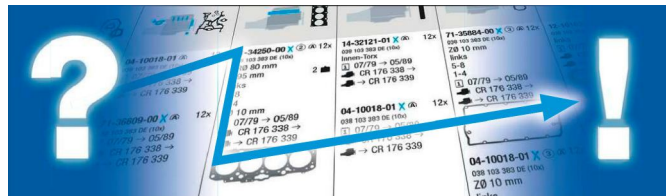



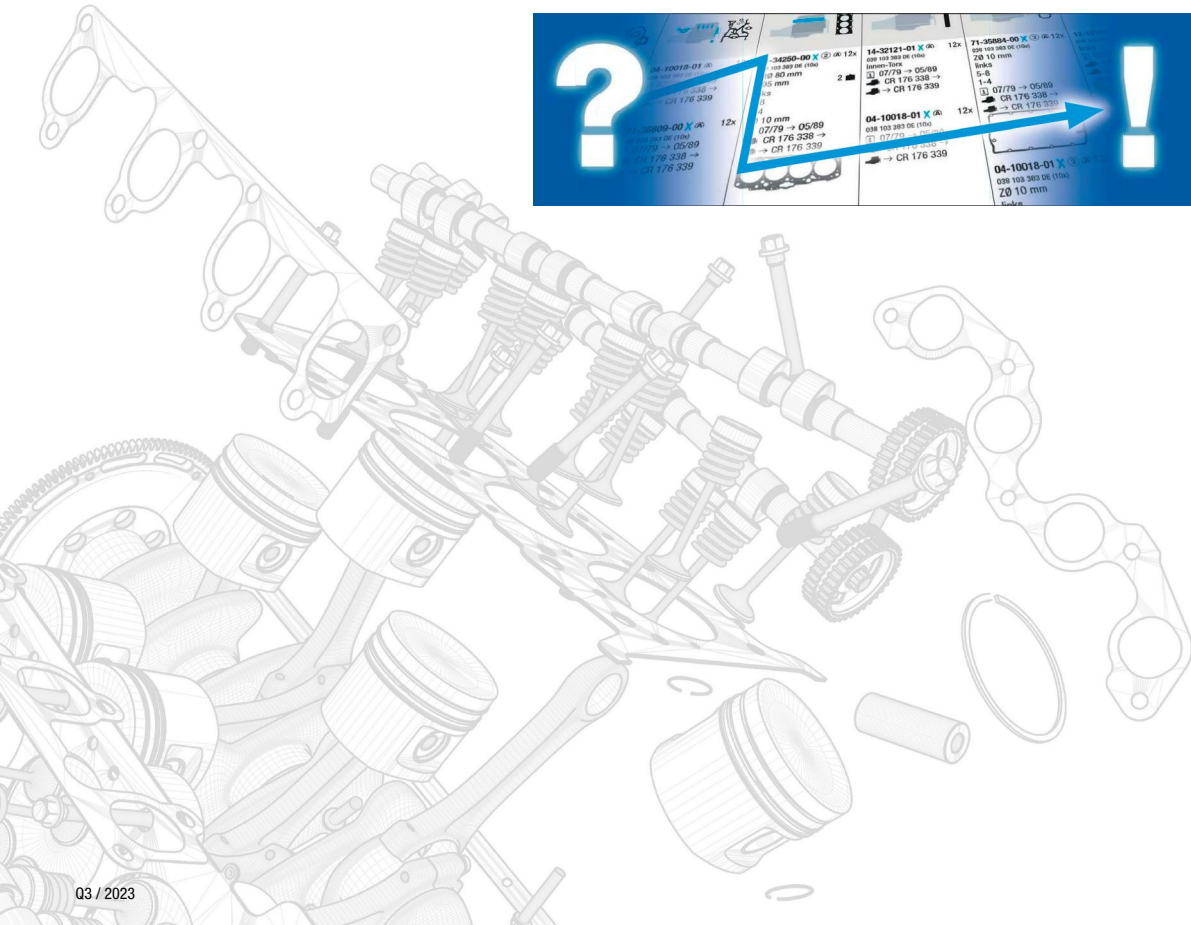





[VictorReinz.com/catalog-info](https://www.victorreinz.com/catalog-info)

















[VictorReinz.com/catalog-how-to-use](https://www.victorreinz.com/catalog-how-to-use)

















MERCEDES-BENZ

 Code		 Code		 Code		 Code		 Code		 Code		 Code	
OM 353.966	17	OM 355.965	19	OM 356.951	26	OM 357.917	26	OM 360.938	21	OM 362.910	22	OM 366.949	26
OM 353.967	17	OM 355.966	19	OM 356.952	26	OM 357.918	26	OM 360.939	21	OM 364.900	23	OM 366.951	25
OM 353.968	17	OM 355.967	19	OM 356.953	26	OM 357.919	26	OM 360.940	21	OM 364.905	23	OM 366.952	25
OM 353.969	17	OM 355.968	19	OM 356.954	25	OM 357.920	29	OM 360.941	21	OM 364.907	23	OM 366.953	26
OM 353.970	18	OM 355.969	19	OM 356.955	25	OM 357.921	29	OM 360.942	21	OM 364.908	23	OM 366.954	26
OM 353.971	18	OM 355.970	19	OM 356.956	25	OM 357.922	29	OM 360.943	21	OM 364.909	23	OM 366.955	25
OM 353.972	18	OM 355.972	19	OM 356.957	25	OM 357.924	29	OM 360.944	21	OM 364.918	23	OM 366.956	26
OM 353.973	18	OM 355.973	19	OM 356.958	25	OM 357.925	28	OM 360.946	21	OM 364.951	23	OM 366.957	25
OM 353.974	18	OM 355.974	19	OM 356.959	27	OM 357.926	28	OM 360.947	21	OM 364.955	23	OM 366.958	26
OM 353.975	18	OM 355.975	19	OM 356.977	20	OM 357.927	29	OM 360.948	21	OM 364.979	23	OM 366.960	25
OM 353.976	18	OM 355.976	19	OM 356.978	28	OM 357.929	29	OM 360.949	21	OM 364.982	23	OM 366.962	26
OM 353.977	18	OM 355.977	19	OM 356.979	29	OM 357.930	29	OM 360.950	21	OM 364.985	23	OM 366.963	26
OM 353.978	18	OM 355.978	19	OM 356.980	29	OM 357.931	28	OM 360.951	21	OM 366.901	20	OM 366.965	25
OM 353.980	17	OM 355.979	19	OM 356.981	25	OM 357.932	29	OM 360.952	21	OM 366.905	25	OM 366.966	27
OM 353.981	17	OM 355.980	19	OM 356.983	22	OM 357.933	29	OM 360.954	21	OM 366.906	25	OM 366.967	26
OM 353.982	17	OM 355.981	19	OM 356.984	25	OM 357.936	28	OM 360.955	21	OM 366.907	25	OM 366.968	26
OM 353.983	17	OM 355.982	19	OM 356.985	26	OM 357.937	28	OM 360.956	21	OM 366.908	26	OM 366.969	26
OM 353.984	17	OM 355.983	19	OM 356.986	27	OM 357.938	20	OM 360.959	21	OM 366.909	25	OM 366.970	26
OM 353.985	17	OM 355.984	19	OM 356.987	25	OM 357.940	29	OM 360.960	21	OM 366.910	25	OM 366.971	26
OM 353.988	17	OM 356.901	25	OM 356.988	20	OM 357.941	29	OM 360.961	21	OM 366.911	25	OM 366.973	26
OM 353.989	17	OM 356.902	25	OM 356.989	29	OM 357.942	29	OM 360.962	21	OM 366.912	26	OM 366.974	27
OM 353.991	18	OM 356.903	26	OM 356.990	26	OM 357.943	29	OM 360.963	21	OM 366.913	25	OM 366.975	26
OM 353.995	17	OM 356.904	25	OM 356.991	29	OM 357.944	29	OM 360.964	21	OM 366.914	25	OM 366.976	27
OM 353.997	18	OM 356.905	25	OM 356.992	27	OM 357.945	29	OM 360.965	21	OM 366.915	26	OM 366.977	26
OM 353.998	17	OM 356.906	25	OM 356.993	22	OM 357.946	29	OM 360.966	21	OM 366.917	25	OM 366.978	27
OM 353.999	17	OM 356.907	25	OM 356.994	27	OM 357.947	29	OM 360.967	21	OM 366.918	26	OM 366.979	27
OM 354.900	23	OM 356.908	25	OM 356.995	27	OM 357.948	29	OM 360.968	21	OM 366.919	25	OM 366.980	30
OM 354.920	23	OM 356.909	26	OM 356.996	22	OM 357.949	28	OM 360.969	21	OM 366.930	25	OM 366.981	25
OM 354.921	23	OM 356.910	25	OM 356.997	25	OM 357.961	30	OM 360.970	21	OM 366.931	26	OM 366.983	25
OM 354.922	23	OM 356.911	25	OM 356.998	25	OM 357.962	30	OM 360.971	21	OM 366.932	25	OM 366.984	26
OM 354.926	18	OM 356.912	25	OM 356.999	29	OM 357.963	26	OM 360.972	21	OM 366.933	25	OM 366.988	30
OM 355.910	19	OM 356.913	25	OM 357.900	26	OM 360.910	21	OM 360.973	21	OM 366.935	25	OM 366.990	25
OM 355.911	19	OM 356.914	25	OM 357.901	26	OM 360.911	21	OM 360.974	21	OM 366.936	25	OM 366.992	30
OM 355.912	19	OM 356.915	25	OM 357.902	26	OM 360.912	21	OM 360.975	21	OM 366.937	26	OM 366.993	26
OM 355.913	19	OM 356.916	25	OM 357.903	26	OM 360.914	21	OM 360.976	21	OM 366.938	25	OM 366.994	26
OM 355.914	19	OM 356.940	25	OM 357.904	25	OM 360.915	21	OM 360.978	21	OM 366.939	26	OM 366.995	26
OM 355.915	19	OM 356.941	27	OM 357.906	27	OM 360.916	21	OM 360.979	21	OM 366.940	25	OM 366.996	25
OM 355.916	19	OM 356.943	25	OM 357.907	27	OM 360.917	21	OM 360.980	21	OM 366.941	26	OM 366.997	30
OM 355.917	19	OM 356.944	26	OM 357.908	26	OM 360.918	21	OM 360.981	21	OM 366.942	26	OM 366.999	22
OM 355.918	19	OM 356.945	27	OM 357.909	27	OM 360.931	21	OM 360.982	21	OM 366.943	26	OM 370.905	23
OM 355.960	19	OM 356.946	26	OM 357.910	27	OM 360.933	21	OM 360.983	21	OM 366.944	27	OM 370.950	23
OM 355.961	19	OM 356.947	27	OM 357.912	25	OM 360.934	21	OM 360.984	21	OM 366.945	26	OM 370.951	23
OM 355.962	19	OM 356.948	26	OM 357.913	25	OM 360.935	21	OM 360.985	21	OM 366.946	26	OM 370.952	23
OM 355.963	19	OM 356.949	26	OM 357.915	25	OM 360.936	21	OM 362.906	22	OM 366.947	26	OM 372.906	22
OM 355.964	19	OM 356.950	25	OM 357.916	26	OM 360.937	21	OM 362.909	22	OM 366.948	26	OM 372.907	22















MERCEDES-BENZ

 Code		 Code		 Code		 Code		 Code		 Code		 Code	
OM 372.930	22	OM 376.962	28	OM 377.984	28	OM 401.973	32	OM 402.982	36	OM 407.952	39	OM 422.959	43
OM 372.950	22	OM 376.963	28	OM 377.985	28	OM 401.974	33	OM 402.983	36	OM 407.953	39	OM 422.963	44
OM 372.951	22	OM 376.964	28	OM 380.940	23	OM 401.975	32	OM 402.984	36	OM 407.954	39	OM 423.901	45
OM 372.953	22	OM 376.967	28	OM 380.942	23	OM 401.977	32	OM 402.985	36	OM 407.955	39	OM 423.905	45
OM 372.956	22	OM 376.968	28	OM 380.943	23	OM 401.978	32	OM 402.986	36	OM 407.956	39	OM 423.906	45
OM 372.958	22	OM 376.969	28	OM 382.912	30	OM 401.979	32	OM 402.987	36	OM 409.906	41	OM 423.907	45
OM 372.959	22	OM 376.970	28	OM 382.913	30	OM 401.980	32	OM 402.989	36	OM 409.907	41	OM 423.908	45
OM 372.960	22	OM 376.972	28	OM 382.919	20	OM 401.981	32	OM 402.990	36	OM 409.908	41	OM 423.909	45
OM 372.961	22	OM 376.975	28	OM 382.970	20	OM 401.984	32	OM 402.995	36	OM 421.901	42	OM 423.950	45
OM 372.962	22	OM 376.976	28	OM 382.971	20	OM 401.985	32	OM 402.996	36	OM 421.905	42	OM 423.951	45
OM 372.964	22	OM 376.977	28	OM 384.906	23	OM 401.986	32	OM 403.900	37	OM 421.906	42	OM 424.900	46
OM 372.980	22	OM 376.980	28	OM 384.907	94	OM 401.987	32	OM 403.905	37	OM 421.907	42	OM 424.901	46
OM 372.981	22	OM 376.981	28	OM 384.908	94	OM 401.989	32	OM 403.906	37	OM 421.908	42	OM 424.901.510	46
OM 372.982	22	OM 376.982	28	OM 386.906	94	OM 401.990	32	OM 403.910	38	OM 421.909	42	OM 427.900	46
OM 372.983	22	OM 376.984	28	OM 386.950	94	OM 401.991	32	OM 403.915	38	OM 421.910	42	OM 427.901	46
OM 372.984	22	OM 376.986	28	OM 386.951	94	OM 401.993	32	OM 403.916	38	OM 421.951	42	OM 427.902	46
OM 372.985	22	OM 376.987	28	OM 386.952	94	OM 401.994	32	OM 403.917	38	OM 422.901	43	OM 427.903	46
OM 372.986	22	OM 376.988	28	OM 386.980	94	OM 402.900	34	OM 403.918	38	OM 422.905	43	OM 427.905	46
OM 372.987	22	OM 376.989	28	OM 386.981	94	OM 402.901	34	OM 403.919	38	OM 422.906	43	OM 427.910	46
OM 374.900	23	OM 376.993	28	OM 386.983	94	OM 402.905	34	OM 403.930	38	OM 422.907	43	OM 427.911	46
OM 374.905	23	OM 376.994	28	OM 401.900	31	OM 402.906	34	OM 403.931	38	OM 422.908	43	OM 427.950	46
OM 374.907	22	OM 376.995	28	OM 401.901	31	OM 402.907	34	OM 403.932	38	OM 422.909	43	OM 427.951	46
OM 374.908	22	OM 376.997	28	OM 401.905	31	OM 402.910	34	OM 403.933	38	OM 422.910	43	OM 427.952	46
OM 374.992	24	OM 376.998	28	OM 401.906	31	OM 402.911	34	OM 403.934	38	OM 422.911	43	OM 429.951	41
OM 376.905	26	OM 376.999	28	OM 401.907	31	OM 402.912	34	OM 403.935	38	OM 422.912	43	OM 429.952	41
OM 376.906	26	OM 377.940	28	OM 401.908	31	OM 402.913	34	OM 407.900	39	OM 422.913	43	OM 429.953	41
OM 376.907	26	OM 377.941	28	OM 401.909	31	OM 402.914	34	OM 407.901	39	OM 422.914	43	OM 429.955	41
OM 376.908	26	OM 377.942	28	OM 401.912	31	OM 402.916	34	OM 407.905	39	OM 422.915	43	OM 440.905	48
OM 376.909	26	OM 377.943	28	OM 401.913	31	OM 402.917	34	OM 407.907	39	OM 422.916	43	OM 440.906	48
OM 376.910	26	OM 377.944	28	OM 401.914	31	OM 402.919	34	OM 407.908	39	OM 422.917	43	OM 440.907	48
OM 376.930	26	OM 377.945	28	OM 401.915	31	OM 402.921	34	OM 407.909	39	OM 422.918	43	OM 440.908	48
OM 376.941	28	OM 377.960	28	OM 401.916	31	OM 402.923	34	OM 407.910	39	OM 422.919	43	OM 440.909	48
OM 376.945	28	OM 377.961	28	OM 401.917	31	OM 402.924	34	OM 407.911	39	OM 422.920	43	OM 440.910	48
OM 376.946	28	OM 377.962	28	OM 401.918	31	OM 402.925	34	OM 407.913	40	OM 422.921	43	OM 440.911	48
OM 376.947	28	OM 377.963	28	OM 401.919	31	OM 402.926	34	OM 407.914	40	OM 422.922	43	OM 440.912	48
OM 376.950	28	OM 377.964	28	OM 401.921	31	OM 402.927	34	OM 407.915	40	OM 422.923	43	OM 440.940	36
OM 376.951	28	OM 377.967	28	OM 401.922	31	OM 402.928	34	OM 407.916	40	OM 422.950	43	OM 440.941	36
OM 376.952	28	OM 377.968	28	OM 401.923	31	OM 402.970	35	OM 407.917	40	OM 422.951	44	OM 440.942	36
OM 376.953	28	OM 377.969	28	OM 401.924	31	OM 402.971	36	OM 407.918	40	OM 422.952	43	OM 440.943	36
OM 376.954	28	OM 377.972	28	OM 401.925	31	OM 402.972	36	OM 407.919	40	OM 422.953	43	OM 440.945	36
OM 376.955	28	OM 377.973	28	OM 401.926	31	OM 402.973	36	OM 407.920	39	OM 422.954	43	OM 440.948	36
OM 376.956	28	OM 377.980	28	OM 401.927	31	OM 402.974	36	OM 407.930	39	OM 422.955	43	OM 440.949	36
OM 376.957	28	OM 377.981	28	OM 401.928	31	OM 402.975	36	OM 407.931	39	OM 422.956	43	OM 440.970	36
OM 376.958	28	OM 377.982	28	OM 401.970	33	OM 402.977	36	OM 407.932	39	OM 422.957	43	OM 440.971	36
OM 376.961	28	OM 377.983	28	OM 401.972	32	OM 402.978	36	OM 407.951	39	OM 422.958	43	OM 440.972	36

MERCEDES-BENZ

 Code		 Code		 Code		 Code		 Code		 Code		 Code	
OM 457.951	52	OM 460.909	57	OM 460.972	57	OM 471.928	63	OM 476.983	50	OM 541.953	65	OM 542.961	69
OM 457.952	51	OM 460.910	57	OM 460.974	56	OM 471.932	64	OM 476.985	50	OM 541.959	65	OM 542.962	69
OM 457.953	52	OM 460.911	57	OM 460.975	56	OM 471.933	64	OM 476.988	50	OM 541.960	65	OM 542.963	69
OM 457.954	53	OM 460.912	57	OM 460.976	56	OM 471.934	64	OM 476.991	50	OM 541.970	65	OM 542.964	69
OM 457.955	54	OM 460.913	57	OM 460.977	56	OM 471.935	63	OM 476.992	50	OM 541.971	65	OM 542.965	69
OM 457.956	52	OM 460.914	57	OM 460.978	56	OM 471.937	64	OM 481.902	42	OM 541.972	65	OM 542.966	69
OM 457.957	52	OM 460.915	57	OM 460.979	56	OM 471.938	64	OM 481.904	42	OM 541.973	65	OM 542.968	69
OM 457.958	52	OM 460.916	57	OM 460.980	56	OM 471.940	64	OM 482.912	43	OM 541.974	65	OM 542.969	69
OM 457.959	51	OM 460.917	57	OM 460.981	56	OM 471.941	64	OM 482.930	43	OM 541.975	65	OM 542.970	69
OM 457.960	52	OM 460.918	57	OM 460.982	56	OM 471.942	64	OM 482.940	43	OM 541.976	65	OM 542.971	69
OM 457.961	52	OM 460.919	57	OM 460.983	56	OM 471.944	64	OM 482.941	43	OM 541.977	65	OM 542.972	69
OM 457.962	52	OM 460.920	57	OM 460.984	57	OM 471.946	64	OM 485.980	51	OM 541.978	65	OM 542.975	69
OM 457.964	51	OM 460.921	57	OM 460.989	55	OM 471.951	63	OM 489.960	51	OM 541.979	65	OM 542.976	69
OM 457.965	51	OM 460.922	57	OM 466.900	50	OM 475.907	51	OM 489.961	51	OM 541.980	65	OM 601.900	70
OM 457.966	51	OM 460.923	57	OM 470.903	57	OM 475.950	51	OM 492.900	43	OM 541.981	65	OM 602.941	70
OM 457.967	51	OM 460.925	57	OM 470.904	57	OM 475.951	51	OM 521.940	65	OM 541.990	65	OM 602.948	70
OM 457.968	52	OM 460.926	55	OM 470.906	57	OM 475.952	51	OM 521.950	65	OM 541.991	65	OM 602.981	71
OM 457.969	52	OM 460.927	55	OM 470.907	57	OM 475.953	51	OM 521.951	65	OM 541.992	65	OM 602.989	71
OM 457.970	52	OM 460.929	57	OM 470.908	57	OM 475.954	51	OM 522.940	69	OM 541.993	65	OM 602.990	70
OM 457.973	51	OM 460.931	57	OM 470.910	57	OM 475.974	51	OM 522.941	69	OM 541.994	65	OM 602.994	71
OM 457.974	51	OM 460.932	55	OM 470.913	57	OM 475.976	51	OM 522.942	69	OM 541.995	65	OM 603.950	72
OM 457.975	52	OM 460.933	55	OM 470.914	57	OM 475.977	51	OM 522.943	69	OM 541.996	65	OM 612.983	95
OM 457.976	52	OM 460.934	55	OM 470.915	57	OM 475.978	51	OM 522.950	69	OM 541.997	65	OM 615.910	72
OM 457.977	52	OM 460.935	55	OM 470.917	57	OM 475.979	51	OM 541.920	65	OM 541.998	65	OM 615.911	72
OM 457.980	52	OM 460.936	55	OM 470.921	57	OM 475.982	51	OM 541.921	65	OM 541.999	65	OM 615.914	72
OM 457.981	52	OM 460.937	55	OM 470.922	57	OM 475.984	51	OM 541.922	65	OM 542.920	68	OM 615.916	72
OM 457.982	55	OM 460.938	55	OM 470.923	57	OM 475.985	51	OM 541.923	65	OM 542.921	68	OM 615.918	72
OM 457.983	55	OM 460.939	55	OM 471.900	58	OM 475.986	51	OM 541.924	65	OM 542.922	68	OM 615.930	73
OM 457.984	52	OM 460.940	55	OM 471.901	58	OM 475.989	51	OM 541.925	65	OM 542.923	69	OM 615.932	73
OM 457.985	55	OM 460.941	55	OM 471.902	59	OM 475.991	51	OM 541.926	65	OM 542.924	69	OM 615.938	72
OM 458.960	54	OM 460.942	55	OM 471.903	59	OM 475.994	51	OM 541.927	65	OM 542.925	68	OM 616.911	73
OM 458.970	52	OM 460.943	55	OM 471.905	58	OM 475.997	51	OM 541.928	65	OM 542.926	69	OM 616.915	73
OM 458.980	52	OM 460.944	55	OM 471.906	59	OM 475.998	51	OM 541.940	65	OM 542.940	67	OM 616.918	73
OM 458.990	52	OM 460.945	55	OM 471.909	58	OM 476.916	50	OM 541.941	65	OM 542.941	69	OM 616.919	73
OM 458.991	52	OM 460.946	55	OM 471.910	60	OM 476.917	50	OM 541.942	65	OM 542.942	68	OM 616.930	73
OM 458.992	52	OM 460.947	55	OM 471.911	60	OM 476.950	50	OM 541.943	65	OM 542.943	69	OM 616.931	73
OM 460.900	57	OM 460.948	55	OM 471.913	61	OM 476.971	50	OM 541.944	65	OM 542.944	68	OM 616.932	73
OM 460.901	57	OM 460.949	55	OM 471.914	61	OM 476.972	50	OM 541.945	65	OM 542.945	69	OM 616.942	73
OM 460.902	57	OM 460.950	55	OM 471.915	62	OM 476.973	50	OM 541.946	65	OM 542.946	69	OM 616.943	73
OM 460.903	57	OM 460.951	55	OM 471.917	62	OM 476.977	50	OM 541.947	65	OM 542.947	69	OM 616.960	74
OM 460.904	57	OM 460.953	55	OM 471.919	63	OM 476.978	50	OM 541.948	66	OM 542.948	69	OM 616.961	74
OM 460.905	57	OM 460.960	52	OM 471.920	62	OM 476.979	50	OM 541.949	65	OM 542.956	69	OM 616.962	74
OM 460.906	57	OM 460.961	52	OM 471.922	63	OM 476.980	50	OM 541.950	65	OM 542.957	69	OM 617.933	74
OM 460.907	57	OM 460.970	57	OM 471.926	63	OM 476.981	50	OM 541.951	65	OM 542.958	69	OM 621.915	74
OM 460.908	57	OM 460.971	57	OM 471.927	63	OM 476.982	50	OM 541.952	65	OM 542.960	69	OM 621.916	75

MERCEDES-BENZ

 Code		 Code		 Code		 Code		 Code		 Code		 Code	
OM 621.931	74	OM 902.935	86	OM 906.912	85	OM 906.959	85	OM 924.912	88	OM 925.960	90	OM 926.969	89
OM 621.932	75	OM 902.936	85	OM 906.913	85	OM 906.960	85	OM 924.913	88	OM 926.910	90	OM 926.970	90
OM 632.997	11	OM 902.937	85	OM 906.914	85	OM 906.961	85	OM 924.914	88	OM 926.911	90	OM 926.971	90
OM 632.998	11	OM 902.938	85	OM 906.915	85	OM 906.962	85	OM 924.915	88	OM 926.912	90	OM 926.972	90
OM 632.999	11	OM 902.939	85	OM 906.916	85	OM 906.963	85	OM 924.916	88	OM 926.913	90	OM 926.973	90
OM 636.914	75	OM 902.960	85	OM 906.917	85	OM 906.964	85	OM 924.917	88	OM 926.914	90	OM 926.974	89
OM 639.939	95	OM 902.961	85	OM 906.918	85	OM 906.965	86	OM 924.919	88	OM 926.915	90	OM 926.975	89
OM 642.864	76	OM 902.970	85	OM 906.919	85	OM 906.966	86	OM 924.920	88	OM 926.916	90	OM 926.976	90
OM 647.981	95	OM 902.971	85	OM 906.920	85	OM 906.967	86	OM 924.922	88	OM 926.917	90	OM 926.984	89
OM 660.950	95	OM 902.972	85	OM 906.921	85	OM 906.968	86	OM 924.923	88	OM 926.918	90	OM 926.985	90
OM 662.911	76	OM 904.905	78	OM 906.922	85	OM 906.970	86	OM 924.924	88	OM 926.919	90	OM 926.986	90
OM 662.940	77	OM 904.906	78	OM 906.923	85	OM 906.971	86	OM 924.925	87	OM 926.920	90	OM 926.987	89
OM 699.302	77	OM 904.907	78	OM 906.924	85	OM 906.973	86	OM 924.927	88	OM 926.921	90	OM 926.988	89
OM 699.303	77	OM 904.909	79	OM 906.925	85	OM 906.974	86	OM 924.928	88	OM 926.924	90	OM 926.989	89
OM 699.304	77	OM 904.910	80	OM 906.926	85	OM 906.975	86	OM 924.929	88	OM 926.925	90	OM 926.990	90
OM 699.305	77	OM 904.911	81	OM 906.927	85	OM 906.976	86	OM 924.930	88	OM 926.926	90	OM 926.991	89
OM 900.910	77	OM 904.915	84	OM 906.928	85	OM 906.977	86	OM 924.931	88	OM 926.927	90	OM 926.992	89
OM 900.911	83	OM 904.916	80	OM 906.929	85	OM 906.978	86	OM 924.932	88	OM 926.928	90	OM 926.993	89
OM 900.912	83	OM 904.922	82	OM 906.930	85	OM 906.979	86	OM 924.933	88	OM 926.929	90	OM 926.994	89
OM 900.913	83	OM 904.927	83	OM 906.931	85	OM 906.980	86	OM 924.934	88	OM 926.930	90	OM 926.995	89
OM 900.915	78	OM 904.928	83	OM 906.932	85	OM 906.981	86	OM 924.935	88	OM 926.932	90	OM 926.996	89
OM 900.920	78	OM 904.930	84	OM 906.933	85	OM 906.982	86	OM 924.936	88	OM 926.933	88	OM 926.997	89
OM 902.910	85	OM 904.941	84	OM 906.934	85	OM 906.983	86	OM 924.937	88	OM 926.934	90	OM 926.998	89
OM 902.911	86	OM 904.942	84	OM 906.935	85	OM 906.985	86	OM 924.938	88	OM 926.935	90	OM 926.999	89
OM 902.912	86	OM 904.943	84	OM 906.936	85	OM 906.986	86	OM 924.940	88	OM 926.936	90	OM 934.911	91
OM 902.913	85	OM 904.945	84	OM 906.937	85	OM 906.988	86	OM 924.941	88	OM 926.937	90	OM 934.912	91
OM 902.914	85	OM 904.949	84	OM 906.938	85	OM 906.990	86	OM 924.942	88	OM 926.938	90	OM 934.913	91
OM 902.915	85	OM 904.952	83	OM 906.939	85	OM 906.991	86	OM 924.980	88	OM 926.939	90	OM 934.914	91
OM 902.916	85	OM 904.953	83	OM 906.940	85	OM 906.992	86	OM 924.981	88	OM 926.940	90	OM 934.971	91
OM 902.917	85	OM 904.957	84	OM 906.941	85	OM 906.993	86	OM 924.982	88	OM 926.941	90	OM 934.972	91
OM 902.918	85	OM 904.962	84	OM 906.944	85	OM 906.994	86	OM 924.985	88	OM 926.942	88	OM 934.974	91
OM 902.919	85	OM 904.965	84	OM 906.945	85	OM 906.995	86	OM 924.986	88	OM 926.944	90	OM 934.976	91
OM 902.920	85	OM 904.966	84	OM 906.946	85	OM 906.998	86	OM 924.987	88	OM 926.945	90	OM 934.978	91
OM 902.921	85	OM 904.967	84	OM 906.947	85	OM 906.999	86	OM 924.988	88	OM 926.946	90	OM 936.910	92
OM 902.922	85	OM 904.968	84	OM 906.948	85	OM 909.900	86	OM 924.989	88	OM 926.947	90	OM 936.912	92
OM 902.923	86	OM 904.970	83	OM 906.949	85	OM 909.901	86	OM 924.990	88	OM 926.948	90	OM 936.913	92
OM 902.924	86	OM 904.972	84	OM 906.950	85	OM 909.910	86	OM 924.991	88	OM 926.949	90	OM 936.915	91
OM 902.925	85	OM 904.973	83	OM 906.951	85	OM 909.911	86	OM 924.993	88	OM 926.950	88	OM 936.916	92
OM 902.926	85	OM 904.976	83	OM 906.952	85	OM 909.920	86	OM 924.994	88	OM 926.951	89	OM 936.917	93
OM 902.927	85	OM 904.984	83	OM 906.953	85	OM 909.921	86	OM 924.995	88	OM 926.952	89	OM 936.919	91
OM 902.930	85	OM 904.985	83	OM 906.954	85	OM 909.960	86	OM 924.996	88	OM 926.959	90	OM 936.923	91
OM 902.931	85	OM 904.986	83	OM 906.955	85	OM 909.970	86	OM 924.997	88	OM 926.960	89	OM 936.971	92
OM 902.932	85	OM 904.987	83	OM 906.956	85	OM 909.971	86	OM 924.998	88	OM 926.961	89	OM 936.972	92
OM 902.933	85	OM 906.910	85	OM 906.957	85	OM 924.910	88	OM 924.999	88	OM 926.963	89	OM 936.973	92
OM 902.934	85	OM 906.911	85	OM 906.958	85	OM 924.911	88	OM 925.920	90	OM 926.968	88	OM 936.974	92

MERCEDES-BENZ



OM 936.975	93
OM 936.977	93
OM 936.980	92
OM 941.910	65
OM 941.920	65
OM 941.921	65
OM 941.929	65
OM 941.930	65
OM 941.940	65
OM 941.960	65
OM 941.970	65
OM 941.980	65
OM 941.981	65
OM 941.990	65
OM 941.991	65
OM 941.992	65
OM 942.900	69
OM 942.910	69
OM 942.911	69
OM 942.912	69
OM 942.925	69
OM 942.930	69
OM 942.960	69
OM 942.967	69
OM 942.970	69
OM 942.980	69
OM 942.990	69

MERCEDES-BENZ

OM 014 A
OM 014 LA



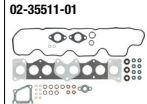
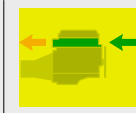

OM 632.997
OM 632.998
OM 632.999

4 Cyl.



02-35511-01

- 61-34465-00
92 Ø
1,3 mm 1
 - 61-34465-10
92 Ø
1,4 mm 2
 - 61-34465-20
92 Ø
1,5 mm 3
 - 61-34465-30
92 Ø
1,6 mm 0
- 
- 61-36655-00
92 Ø
1,3 mm
MLS
 - 61-36655-10
92 Ø
1,4 mm
MLS
 - 61-36655-20
92 Ø
1,5 mm
MLS
 - 61-36655-30
92 Ø
1,6 mm
MLS
- 

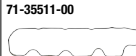

71-35511-00

- 12-26545-01
 - 70-26545-00 8x
- 

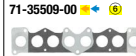

71-35509-00



70-31414-10

M 180

M 180.952
M 180.953

6 Cyl.

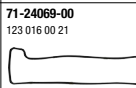

71-24069-00
123 016 00 21

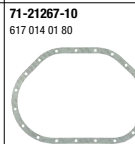



71-21267-10
617 014 01 80

M 276 DE 35

M 276.962

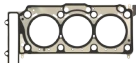
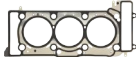
6 Cyl.

- 61-10090-00 L
276 016 02 20
93,5 Ø
MLS
 - 61-10091-00 R
276 016 05 20
93,5 Ø
MLS
- 
- 

- 14-32215-01 2x
272 016 01 69 (8x)
- 



70-31414-10

- 12-31306-05
606 050 00 58
 - 70-31306-00 24x
- 

- 71-10759-00 6x
276 141 00 80
 - 71-10760-00 6x
276 141 01 80
- 
- 



70-31414-10

- 81-26248-10 K
014 997 70 46
45x67
A SL RD PTFE
 - 81-10449-00 K
276 010 00 07
96 Ø
PTFE
- 
- 

MERCEDES-BENZ

M 276 DE 35 LA
 M 276.851
 M 276.852
 M 276.854
 M 276.855

6 Cyl.

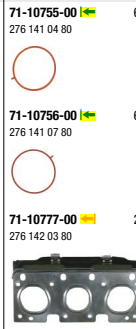
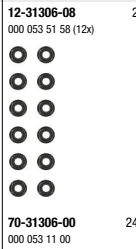
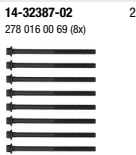
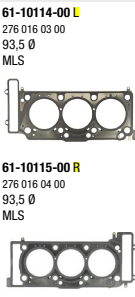
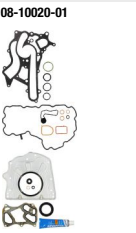
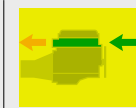

OM 312 D 46
 OM 312.954

6 Cyl.

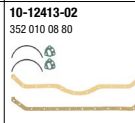
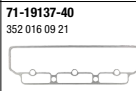
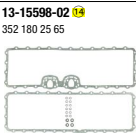







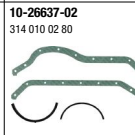
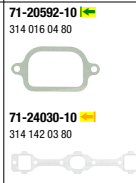
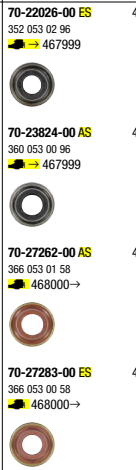
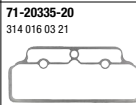
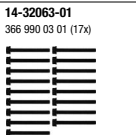
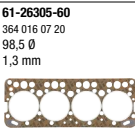
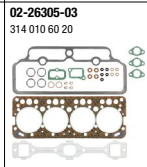
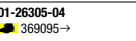



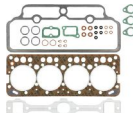



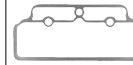





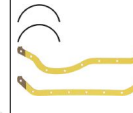



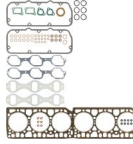

OM 314
 OM 314 A

OM 314.956
 OM 314.970

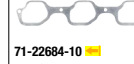



















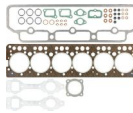

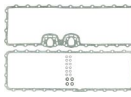

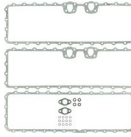











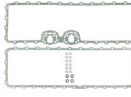











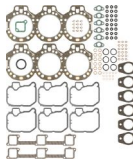



4 Cyl.



MERCEDES-BENZ

<p>OM 314</p> <p>OM 314.910 OM 314.916 OM 314.917 OM 314.944 OM 314.957 OM 314.964 OM 314.965 OM 340.932 OM 343.910 OM 343.932 OM 343.934</p>	<p>01-26305-03 369095→</p>	<p>02-26305-03 314 010 60 20</p> 	<p>08-12414-02 314 010 81 08 369094</p> 		<p>61-26305-60 364 016 07 20 98,5 Ø 1,3 mm</p> 	<p>14-32063-01 366 990 03 01 (17x)</p> 	<p>71-20335-20 314 016 03 21</p> 	<p>70-22026-00 ES 4x 352 053 02 96 467999</p>  <p>70-23824-00 AS 4x 360 053 00 96 467999</p>  <p>70-27262-00 AS 4x 366 053 01 58 468000→</p>  <p>70-27283-00 ES 4x 366 053 00 58 468000→</p> 	<p>71-20592-10 4x 314 016 04 80</p>  <p>71-24030-10 4x 314 142 03 80</p> 	<p>10-13034-01 364 010 01 80</p>  <p>71-13056-00 364 010 11 80</p> 	<p>81-20504-40 K↔ 014 997 16 47 65x90 A FIL RD FPM 369095→</p>  <p>71-24488-10 K↔ 001 997 41 41 (2x)</p> 
<p>OM 326 OM 326 h</p> <p>OM 326.910 OM 326.911 OM 326.912 OM 326.914 OM 326.915 OM 326.918 OM 326.918 OM 326.971 OM 326.972 OM 326.973 OM 326.974 OM 326.975 OM 326.977 OM 326.980 OM 326.983 OM 326.988</p>					<p>61-55639-00 6x 3260161420 7500130→</p>				<p>71-10447-60 6x 355 142 05 80</p> 	<p>10-14786-03 355 010 00 27</p> 	
<p>OM 327</p> <p>OM 327.910 OM 327.914 OM 327.915 OM 327.916 OM 327.917 OM 327.918 OM 327.919 OM 327.931 OM 327.932 OM 327.933 OM 327.934 OM 327.935 OM 327.936 OM 327.937 OM 327.938 OM 327.939 OM 327.940 OM 327.941 OM 327.942 OM 327.943 OM 327.944 OM 327.945 OM 327.946</p>		<p>02-22895-03 360 010 33 20</p> 			<p>61-22895-40 360 016 05 20 117 Ø 1,3 mm</p> 		<p>71-21032-20 2x 360 016 02 21</p> 	<p>70-23824-00 12x 360 053 00 96</p> 	<p>71-21034-10 2x 360 141 01 80</p>  <p>71-22684-10 2x 360 142 03 80</p>  <p>71-09752-20 16 066 492 00 80</p> 	<p>71-21031-20 360 014 03 22</p> 	<p>81-20309-20 K↔ 011 997 57 47 75x100 B SL RD FPM</p>  <p>81-21040-10 K↔ 004 997 93 47 125x160 B SL LD FPM</p> 

MERCEDES-BENZ

											
<p>OM 344 OM 352 A</p> <p>OM 344.913 OM 344.934 OM 344.937 OM 344.938 OM 344.939 OM 344.951</p> <p>6 Cyl.</p>		<p>02-27350-05 352 010 26 21 +346 017 01 60 (6x) +016 997 82 48 (6x)</p> 		<p>13-15598-02  352 180 25 65  730880</p>  <p>13-15598-03  366 180 37 65  730881→</p> 	<p>61-27350-40 366 016 06 20 98,5 Ø 1,3 mm</p> 		<p>71-19137-40 352 016 09 21</p> 		<p>71-24004-10  2x 352 142 04 80</p> 	<p>10-12413-02 352 010 08 80</p> 	<p>81-20504-40  014 997 16 47 65x90 A FIL RD FPM</p>  <p>71-24488-10  001 997 41 41 (2x)</p> 
<p>OM 344 OM 352 A</p> <p>OM 344.940 OM 344.948 OM 344.949 OM 344.952</p> <p>6 Cyl.</p>				<p>13-15598-02  352 180 25 65  730880</p>  <p>13-15598-03  366 180 37 65  730881→</p> 	<p>61-27350-40 366 016 06 20 98,5 Ø 1,3 mm</p> 		<p>71-19137-40 352 016 09 21</p> 		<p>71-24004-10  2x 352 142 04 80</p> 	<p>10-12413-02 352 010 08 80</p> 	<p>81-20504-40  014 997 16 47 65x90 A FIL RD FPM</p>  <p>71-24488-10  001 997 41 41 (2x)</p> 
<p>OM 346 OM 346 h</p> <p>OM 346.910 OM 346.911 OM 346.912 OM 346.913 OM 346.914 OM 346.915 OM 346.916 OM 346.917 OM 346.918 OM 346.919 OM 346.940 OM 346.941 OM 346.942 OM 346.943 OM 346.944 OM 346.945 OM 346.946 OM 346.947 OM 346.952 OM 346.953</p> <p>6 Cyl.</p>		<p>02-21760-06 355 010 12 20 +352 053 02 96 (24x)</p> 	<p>08-14786-01 346 010 20 08</p>		<p>61-21760-40 2x 355 016 02 20 130 Ø 1,3 mm</p> 		<p>71-20041-30 6x 355 016 00 21</p> 	<p>70-22026-00 24x 352 053 02 96</p> 	<p>71-20231-30  2x 355 141 02 80</p>  <p>71-10447-60 6x 355 142 05 80</p>  <p>71-09752-20   066 482 00 80</p> 	<p>10-14786-03 355 010 00 27</p> 	<p>81-20309-20  011 997 57 47 75x100 B SL RD FPM</p>  <p>71-20311-00  315 030 00 80 24x52 Filz</p> 

MERCEDES-BENZ

OM 352
OM 344.943
OM 344.945
6 Cyl.

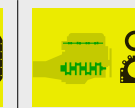
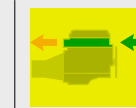

01-27350-06
760548

02-27350-05
352 010 26 21
+346 017 01 60 (6x)
+016 997 82 48 (6x)

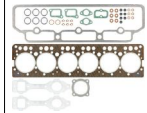

61-27350-40
366 016 06 20
98,5 Ø
1,3 mm



14-32063-02
366 990 03 01 (25x)
706241

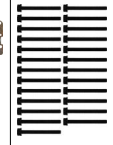

71-19137-40
352 016 09 21



70-22026-00 ES
352 053 02 96
794938



70-23824-00 AS
360 053 00 96
794938



70-27262-00 AS
366 053 01 58
794939



70-27283-00 ES
366 053 00 58
794939



71-24004-10
352 142 04 80



10-12413-02
352 010 08 80



71-13055-00
366 010 06 80



81-20504-40 K
014 997 16 47
65x90
A FIL RD FPM
598250



71-24488-10 K
001 997 41 41 (2x)



OM 352
OM 352 A
OM 344.912
OM 344.930
OM 344.931
OM 344.932
OM 344.933
OM 344.941
OM 344.944
OM 344.946
OM 344.963
6 Cyl.

01-27350-06
760548

01-27350-10
760549

02-27350-05
352 010 26 21
+346 017 01 60 (6x)
+016 997 82 48 (6x)

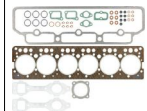

61-27350-40
366 016 06 20
98,5 Ø
1,3 mm



14-32063-02
366 990 03 01 (25x)
706241

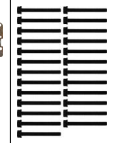

71-19137-40
352 016 09 21



70-22026-00 ES
352 053 02 96
794938



70-23824-00 AS
360 053 00 96
794938



70-27262-00 AS
366 053 01 58
794939



70-27283-00 ES
366 053 00 58
794939



71-24004-10
352 142 04 80



10-12413-02
352 010 08 80



71-13055-00
366 010 06 80



81-20504-40 K
014 997 16 47
65x90
A FIL RD FPM
598250



71-24488-10 K
001 997 41 41 (2x)













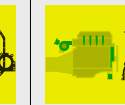
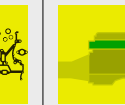
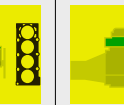

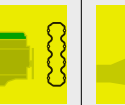
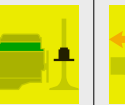
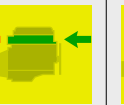

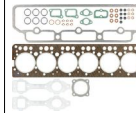

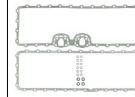

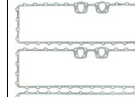







MERCEDES-BENZ

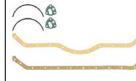





















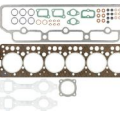



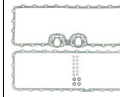

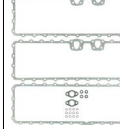



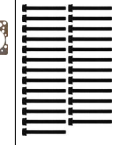











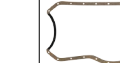





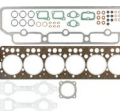







OM 352
OM 352 A
OM 352 MBSA
OM 352 DE 57

OM 352.901
OM 352.902
OM 352.903
OM 352.904
OM 352.905
OM 352.907
OM 352.908
OM 352.909
OM 352.910
OM 352.912
OM 352.914
OM 352.915
OM 352.917
OM 352.919
OM 352.930
OM 352.931
OM 352.932
OM 352.933
OM 352.934
OM 352.935
OM 352.936
OM 352.938
OM 352.939
OM 352.942
OM 352.943
OM 352.944
OM 352.945
OM 352.948
OM 352.953
OM 352.954
OM 352.955
OM 352.959
OM 352.963
OM 352.964
OM 352.965
OM 352.966
OM 352.967
OM 352.969
OM 352.970
OM 352.971
OM 352.972
OM 352.973
OM 352.974
OM 352.975
OM 352.976
OM 352.978
OM 352.979
OM 352.980
OM 352.981
OM 352.982
OM 352.983
OM 352.984
OM 352.985
OM 352.986
OM 352.987
OM 352.989
OM 352.990
OM 352.991
OM 352.992
OM 352.993
OM 352.996
OM 352.997
OM 352.998
OM 352.999
OM 353.900
OM 353.901
OM 353.902
OM 353.903
OM 353.904
OM 353.905
OM 353.906
OM 353.907
OM 353.915
OM 353.916
OM 353.917
OM 353.922
OM 353.923
OM 353.930
OM 353.932
OM 353.936
OM 353.940

6 Cyl.

											
<p>01-27350-06 → 760548</p> <p>01-27350-10 → 760549→</p>	<p>02-27350-05 352 010 26 21 +346 017 01 60 (6x) +016 997 82 48 (6x)</p> 		<p>13-15598-02  352 180 25 65 → 730880</p>   <p>13-15598-03  366 180 37 65 → 730881→</p>  	<p>61-27350-40 366 016 06 20 98,5 Ø 1,3 mm</p> 	<p>14-32063-02 366 990 03 01 (25x) → 706241</p> 	<p>71-19137-40 352 016 09 21</p> 	<p>70-22026-00 ES 6x 352 053 02 96 → 794938</p>  <p>70-23824-00 AS 6x 360 053 00 96 → 794938</p>  <p>70-27262-00 AS 6x 366 053 01 58 → 794939→</p>  <p>70-27283-00 ES 6x 366 053 00 58 → 794939→</p> 	<p>71-24004-10 2x 352 142 04 80</p> 	<p>10-12413-02 352 010 08 80</p>  <p>71-13055-00 366 010 06 80</p> 	<p>81-20504-40 K  014 997 16 47 65x90 A FIL RD FPM → 598250→</p>  <p>71-24488-10 K  001 997 41 41 (2x)</p> 	

MERCEDES-BENZ

MERCEDÉS-BENZ													
OM 352 OM 352 A OM 352 MBSA OM 352 DE 57	OM 353.941 OM 353.942 OM 353.943 OM 353.944 OM 353.945 OM 353.946 OM 353.949 OM 353.950 OM 353.960 OM 353.961 OM 353.962 OM 353.963 OM 353.964 OM 353.965 OM 353.966 OM 353.967 OM 353.968 OM 353.969 OM 353.980 OM 353.981 OM 353.982 OM 353.983 OM 353.984 OM 353.985 OM 353.988 OM 353.989 OM 353.995 OM 353.999	6 Cyl.	 01-27350-06 → 760548 01-27350-10 → 760549→	 02-27350-05 352 010 26 21 +346 017 01 60 (6x) +016 997 82 48 (6x) 		 13-15598-02  352 180 25 65 → 730880  13-15598-03  366 180 37 65 → 730881→ 	 61-27350-40 366 016 06 20 98,5 Ø 1,3 mm 	 14-32063-02 366 990 03 01 (25x) → 706241 	 71-19137-40 352 016 09 21 	 70-22026-00 ES 352 053 02 96 → 794938  70-23824-00 AS 360 053 00 96 → 794938  70-27262-00 AS 366 053 01 58 → 794939→  70-27283-00 ES 366 053 00 58 → 794939→ 	 71-24004-10  352 142 04 80 	 10-12413-02 352 010 08 80  71-13055-00 366 010 06 80 	 81-20504-40 K  014 997 16 47 65x90 A FIL RD FPM → 598250→  71-24488-10 K  001 997 41 41 (2x) 
OM 352	OM 341.910 OM 341.911 OM 341.912 OM 341.915 OM 341.918 OM 341.919 OM 341.931 OM 341.932 OM 341.934 OM 341.935 OM 341.936 OM 341.938 OM 341.941 OM 341.946 OM 341.948 OM 341.949 OM 341.951 OM 341.995 OM 344.905	6 Cyl.	01-27350-06	 02-27350-05 352 010 26 21 +346 017 01 60 (6x) +016 997 82 48 (6x) 		 61-27350-40 366 016 06 20 98,5 Ø 1,3 mm 	 14-32063-02 366 990 03 01 (25x) 	 71-19137-40 352 016 09 21 	 70-22026-00 ES 352 053 02 96 → 794938  70-23824-00 AS 360 053 00 96 → 794938  70-27262-00 AS 366 053 01 58 → 794939→  70-27283-00 ES 366 053 00 58 → 794939→ 	 71-24004-10  352 142 04 80 	 10-12413-02 352 010 08 80 		

MERCEDES-BENZ

OM 352 A
OM 352 A MBSA
OM 352 MBSA
OM 352/3
OM 353

OM 352.913
OM 352.916
OM 352.918
OM 352.937
OM 352.946
OM 352.949
OM 352.950
OM 352.968
OM 352.988
OM 352.994
OM 353.909
OM 353.910
OM 353.911
OM 353.912
OM 353.913
OM 353.914
OM 353.920
OM 353.921
OM 353.931
OM 353.933
OM 353.934
OM 353.935
OM 353.937
OM 353.938
OM 353.939
OM 353.951
OM 353.952
OM 353.953
OM 353.954
OM 353.957
OM 353.958
OM 353.959
OM 353.970
OM 353.971
OM 353.972
OM 353.973
OM 353.974
OM 353.975
OM 353.976
OM 353.977
OM 353.978
OM 353.991
OM 353.997

OM 354

OM 354.926

6 Cyl.

4 Cyl.



01-27350-09
760548
01-27350-11
760549→



02-27350-05
352 010 26 21
+346 017 01 60 (6x)
+016 997 82 48 (6x)

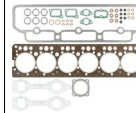

13-15598-02 (1x)
352 180 25 65
730880

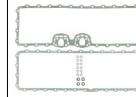

13-15598-03 (1x)
366 180 37 65
730881→

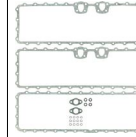

61-27350-40
366 016 06 20
98,5 Ø
1,3 mm



14-32063-02
366 990 03 01 (25x)
706241



71-19137-40
352 016 09 21



70-22026-00 ES
352 053 02 96
794938



70-23824-00 AS
360 053 00 96
794938



70-27262-00 AS
366 053 01 58
794939→



70-27283-00 ES
366 053 00 58
794939→

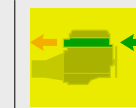

71-24004-10
352 142 04 80



71-09752-20 (1x)
066 492 00 80



10-12413-02
352 010 08 80



71-13055-00
366 010 06 80

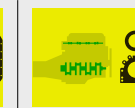

81-20504-40 K
014 997 16 47
65x90
A FIL RD FPM
598250→



71-24488-10 K
001 997 41 41 (2x)



02-26305-04
364 010 53 20
+346 017 01 60 (4x)
+016 997 82 48 (4x)

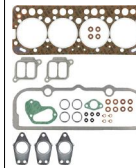

08-25508-08
364 010 22 08



61-26305-60
364 016 07 20
98,5 Ø
1,3 mm



14-32063-01
366 990 03 01 (17x)



71-26306-30
364 016 01 21



70-27262-00 AS
366 053 01 58



70-27283-00 ES
366 053 00 58



71-26323-20
366 141 10 80



71-26283-00
366 142 04 80



10-26637-02
314 010 02 80

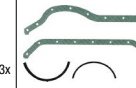

81-20504-40 K
014 997 16 47
65x90
A FIL RD FPM



71-24488-10 K
001 997 41 41 (2x)



















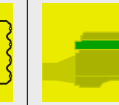
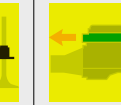
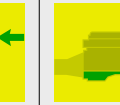







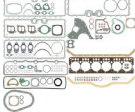







MERCEDES-BENZ

<p>OM 355 OM 355 A OM 355 h</p>	<p>OM 335.910 OM 335.930 OM 335.932 OM 355.960 OM 355.961 OM 355.962 OM 355.963 OM 355.964 OM 355.965 OM 355.966 OM 355.967 OM 355.968 OM 355.969 OM 355.970 OM 355.972 OM 355.973 OM 355.974 OM 355.975 OM 355.976 OM 355.977 OM 355.978 OM 355.979 OM 355.980 OM 355.981 OM 355.982 OM 355.983 OM 355.984</p>	<p>OM 335.910 OM 335.930 OM 335.932 OM 355.960 OM 355.961 OM 355.962 OM 355.963 OM 355.964 OM 355.965 OM 355.966 OM 355.967 OM 355.968 OM 355.969 OM 355.970 OM 355.972 OM 355.973 OM 355.974 OM 355.975 OM 355.976 OM 355.977 OM 355.978 OM 355.979 OM 355.980 OM 355.981 OM 355.982 OM 355.983 OM 355.984</p>	<p>OM 335.910 OM 335.930 OM 335.932 OM 355.960 OM 355.961 OM 355.962 OM 355.963 OM 355.964 OM 355.965 OM 355.966 OM 355.967 OM 355.968 OM 355.969 OM 355.970 OM 355.972 OM 355.973 OM 355.974 OM 355.975 OM 355.976 OM 355.977 OM 355.978 OM 355.979 OM 355.980 OM 355.981 OM 355.982 OM 355.983 OM 355.984</p>		<p>OM 335.910 OM 335.930 OM 335.932 OM 355.960 OM 355.961 OM 355.962 OM 355.963 OM 355.964 OM 355.965 OM 355.966 OM 355.967 OM 355.968 OM 355.969 OM 355.970 OM 355.972 OM 355.973 OM 355.974 OM 355.975 OM 355.976 OM 355.977 OM 355.978 OM 355.979 OM 355.980 OM 355.981 OM 355.982 OM 355.983 OM 355.984</p>						<p>OM 335.910 OM 335.930 OM 335.932 OM 355.960 OM 355.961 OM 355.962 OM 355.963 OM 355.964 OM 355.965 OM 355.966 OM 355.967 OM 355.968 OM 355.969 OM 355.970 OM 355.972 OM 355.973 OM 355.974 OM 355.975 OM 355.976 OM 355.977 OM 355.978 OM 355.979 OM 355.980 OM 355.981 OM 355.982 OM 355.983 OM 355.984</p>
<p>OM 355 OM 355 A OM 355 LA OM 355.I OM 355.II OM 355.III OM 355/6 A OM 355.1</p>	<p>OM 345.910 OM 345.912 OM 345.913 OM 345.914 OM 345.932 OM 345.933 OM 345.936 OM 345.937 OM 345.950 OM 345.952 OM 345.953 OM 345.960</p>	<p>OM 345.910 OM 345.912 OM 345.913 OM 345.914 OM 345.932 OM 345.933 OM 345.936 OM 345.937 OM 345.950 OM 345.952 OM 345.953 OM 345.960</p>	<p>OM 345.910 OM 345.912 OM 345.913 OM 345.914 OM 345.932 OM 345.933 OM 345.936 OM 345.937 OM 345.950 OM 345.952 OM 345.953 OM 345.960</p>	<p>OM 345.910 OM 345.912 OM 345.913 OM 345.914 OM 345.932 OM 345.933 OM 345.936 OM 345.937 OM 345.950 OM 345.952 OM 345.953 OM 345.960</p>	<p>OM 345.910 OM 345.912 OM 345.913 OM 345.914 OM 345.932 OM 345.933 OM 345.936 OM 345.937 OM 345.950 OM 345.952 OM 345.953 OM 345.960</p>						<p>OM 345.910 OM 345.912 OM 345.913 OM 345.914 OM 345.932 OM 345.933 OM 345.936 OM 345.937 OM 345.950 OM 345.952 OM 345.953 OM 345.960</p>
<p>OM 355</p>	<p>OM 355.910 OM 355.911 OM 355.912 OM 355.913 OM 355.914 OM 355.915 OM 355.916 OM 355.917 OM 355.918</p>	<p>OM 355.910 OM 355.911 OM 355.912 OM 355.913 OM 355.914 OM 355.915 OM 355.916 OM 355.917 OM 355.918</p>	<p>OM 355.910 OM 355.911 OM 355.912 OM 355.913 OM 355.914 OM 355.915 OM 355.916 OM 355.917 OM 355.918</p>		<p>OM 355.910 OM 355.911 OM 355.912 OM 355.913 OM 355.914 OM 355.915 OM 355.916 OM 355.917 OM 355.918</p>						<p>OM 355.910 OM 355.911 OM 355.912 OM 355.913 OM 355.914 OM 355.915 OM 355.916 OM 355.917 OM 355.918</p>

<p>01-21760-07 355 586 03 90</p>	<p>02-21760-06 355 010 12 20 +352 053 02 96 (24x)</p> <p>02-21760-07 355 010 12 20</p>	<p>08-14786-04 355 010 55 08</p>		<p>61-21760-40 2x 355 016 02 20 130 Ø 1,3 mm</p>		<p>71-20041-30 6x 355 016 00 21</p>	<p>70-22026-00 24x 352 053 02 96</p>	<p>71-20231-30 2x 355 141 02 80</p> <p>71-10447-60 6x 355 142 05 80</p> <p>71-09752-20 16 066 492 00 80</p>	<p>10-14786-03 355 010 00 27</p>	<p>81-20309-20 K 011 997 57 47 75x100 B SL RD FPM</p> <p>71-20311-00 K 315 030 00 80 24x52 Filz</p>
---	--	---	--	---	--	--	---	--	---	---

<p>01-21760-07 355 586 03 90</p>	<p>02-21760-07 355 010 12 20</p>	<p>08-14786-04 355 010 55 08</p>	<p>71-12408-00 2 346 014 01 20</p>	<p>61-21760-40 2x 355 016 02 20 130 Ø 1,3 mm</p>		<p>71-20041-30 6x 355 016 00 21</p>	<p>12-22026-02 24x 352 053 02 96</p>	<p>71-20231-30 2x 355 141 02 80</p> <p>71-10447-60 6x 355 142 05 80</p>	<p>10-14786-03 355 010 00 27</p>	<p>81-20309-20 K 011 997 57 47 75x100 B SL RD FPM</p> <p>71-20311-00 K 315 030 00 80 24x52 Filz</p>
---	---	---	---	---	--	--	---	---	---	---

	<p>02-21760-06 355 010 12 20 +352 053 02 96 (24x)</p>			<p>61-21760-40 2x 355 016 02 20 130 Ø 1,3 mm</p>		<p>71-20041-30 6x 355 016 00 21</p>	<p>70-22026-00 24x 352 053 02 96</p>	<p>71-20231-30 2x 355 141 02 80</p> <p>71-10447-60 6x 355 142 05 80</p> <p>71-09752-20 16 066 492 00 80</p>	<p>10-14786-03 355 010 00 27</p>	<p>81-20309-20 K 011 997 57 47 75x100 B SL RD FPM</p> <p>71-20311-00 K 315 030 00 80 24x52 Filz</p>
--	--	--	--	---	--	--	---	--	---	---









MERCEDES-BENZ													
OM 355/5 OM 355/5 A OM 355/5.1	OM 345.915 OM 345.919 OM 345.941 OM 345.942 OM 345.945 OM 345.946 OM 345.947 OM 345.949 OM 345.970 OM 345.972 OM 345.973 OM 345.974 OM 345.975 OM 345.977 OM 345.978 OM 347.915 OM 347.942 OM 347.943	5 Cyl.				71-12408-00  346 014 01 20 			71-20041-30 355 016 00 21 	70-22026-00 352 053 02 96 	71-10447-60  355 142 05 80 		
OM 356 OM 357 OM 366 OM 366 LA OM 382	OM 356.977 OM 356.988 OM 357.938 OM 366.901 OM 382.919 OM 382.970 OM 382.971	6 Cyl.	01-27350-07 	02-27350-06 366 010 71 20 +346 017 01 60 (6x) +016 997 82 48 (6x) 	08-25508-07 366 010 44 08 		61-27350-40 366 016 06 20 98,5 Ø 1,3 mm 	14-32063-02 366 990 03 01 (25x) 	71-26284-30 366 016 03 21 	70-27262-00 AS 366 053 01 58  70-27283-00 ES 366 053 00 58 	6x 71-26323-20  366 141 10 80  71-26283-00  366 142 04 80 	3x 10-12413-02 352 010 08 80  71-13055-00 366 010 06 80 	81-20504-40  014 997 16 47 65x90 A FIL RD FPM  71-24488-10  001 997 41 41 (2x) 







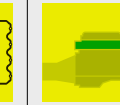
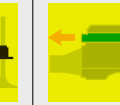
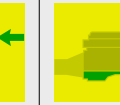









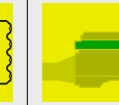
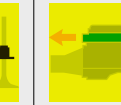
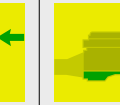

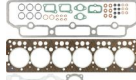

























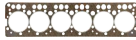









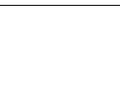



MERCEDES-BENZ

OM 360
OM 360 A
OM 360 H

















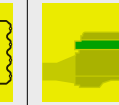
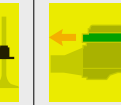
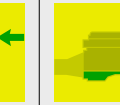

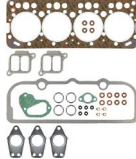











OM 360.910
OM 360.911
OM 360.912
OM 360.914
OM 360.915
OM 360.916
OM 360.917
OM 360.918
OM 360.931
OM 360.933
OM 360.934
OM 360.935
OM 360.936
OM 360.937
OM 360.938
OM 360.939
OM 360.940
OM 360.941
OM 360.942
OM 360.943
OM 360.944
OM 360.946
OM 360.947
OM 360.948
OM 360.949
OM 360.950
OM 360.951
OM 360.952
OM 360.954
OM 360.955
OM 360.956
OM 360.959
OM 360.960
OM 360.961
OM 360.962
OM 360.963
OM 360.964
OM 360.965
OM 360.966
OM 360.967
OM 360.968
OM 360.969
OM 360.970
OM 360.971
OM 360.972
OM 360.973
OM 360.974
OM 360.975
OM 360.976
OM 360.978
OM 360.979
OM 360.980
OM 360.981
OM 360.982
OM 360.983
OM 360.984
OM 360.985

6 Cyl.





















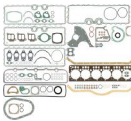
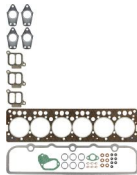
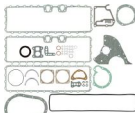











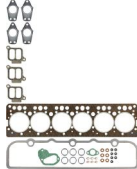

										
01-22895-06 360 010 03 44	02-22895-03 360 010 33 20			61-22895-40 360 016 05 20 117 Ø 1,3 mm	14-32273-01 327 990 05 04 (26x)	71-21032-20 360 016 02 21	70-23824-00 360 053 00 96	71-21034-10 360 141 01 80 71-22684-10 360 142 03 80 71-09752-20 066 492 00 80	71-21031-20 360 014 03 22	81-20309-20 011 997 57 47 75x100 B SL RD FPM 81-21040-10 004 997 93 47 125x160 B SL LD FPM

MERCEDES-BENZ													
OM 362 LA	OM 362.906 OM 362.909 OM 362.910	6 Cyl.		02-27350-05 352 010 26 21 +346 017 01 60 (6x) +016 997 82 48 (6x)   	08-25508-06 353 010 48 08   		61-27350-40 366 016 06 20 98,5 Ø 1,3 mm 		71-19137-40 352 016 09 21 	70-22026-00 ES 6x 352 053 02 96 → 794938  70-23824-00 AS 6x 360 053 00 96 → 794938  70-27262-00 AS 6x 366 053 01 58 → 794939→  70-27283-00 ES 6x 366 053 00 58 → 794939→ 	71-24004-10 2x 352 142 04 80 	10-12413-02 352 010 08 80  71-13055-00 366 010 06 80 	81-20504-40 K → 014 997 16 47 65x90 A FIL RD FPM  71-24488-10 K → 001 997 41 41 (2x) 
OM 363 A OM 366 OM 366 A OM 366 LA	OM 356.983 OM 356.993 OM 356.996 OM 366.999 OM 372.906 OM 372.907 OM 372.930 OM 372.950 OM 372.951 OM 372.953 OM 372.956 OM 372.958 OM 372.959 OM 372.960 OM 372.961 OM 372.962 OM 372.964 OM 372.980 OM 372.981 OM 372.982 OM 372.983 OM 372.984 OM 372.985 OM 372.986 OM 372.987	6 Cyl.		02-27350-06 366 010 71 20 +346 017 01 60 (6x) +016 997 82 48 (6x)  	08-25508-07 366 010 44 08   	04-10070-01 03   	61-27350-40 366 016 06 20 98,5 Ø 1,3 mm 	14-32063-02 366 990 03 01 (25x) 	71-26284-30 366 016 03 21 	70-27262-00 AS 6x 366 053 01 58  70-27283-00 ES 6x 366 053 00 58 	71-26323-20 3x 366 141 10 80 	10-12413-02 352 010 08 80  71-13055-00 366 010 06 80 	81-20504-40 K → 014 997 16 47 65x90 A FIL RD FPM  71-24488-10 K → 001 997 41 41 (2x) 
OM 364	OM 374.907 OM 374.908	4 Cyl.		02-26305-02 364 010 40 20 +346 017 01 60 (6x) +016 997 82 48 (6x)   	08-25508-08 364 010 22 08   		61-26305-60 364 016 07 20 98,5 Ø 1,3 mm 		71-26306-30 364 016 01 21 	70-27262-00 AS 4x 366 053 01 58  70-27283-00 ES 4x 366 053 00 58 	71-26323-30 2x 366 141 05 80 	10-13034-01 364 010 01 80  	

MERCEDES-BENZ														
OM 364 OM 364 A	OM 364.905 OM 364.908 OM 364.909 OM 364.951 OM 370.905 OM 370.950 OM 370.951 OM 370.952	4 Cyl.												
				02-26305-02 364 010 40 20 +346 017 01 60 (6x) +016 997 82 48 (6x) 	08-25508-08 364 010 22 08 		61-26305-60 364 016 07 20 98,5 Ø 1,3 mm 	14-32063-01 366 990 03 01 (17x) 	71-26306-30 364 016 01 21 	70-27262-00 AS 366 053 01 58 	4x 71-26323-30 I 2x 366 141 05 80 71-26283-00 3x 366 142 04 80	10-26637-02 314 010 02 80 	81-20504-40 K 014 997 16 47 65x90 A FIL RD FPM 71-24488-10 K 001 997 41 41 (2x)	
OM 364 OM 364 A	OM 364.979 OM 374.900	4 Cyl.			08-25508-08 364 010 22 08 		61-26305-60 364 016 07 20 98,5 Ø 1,3 mm 		71-26306-30 364 016 01 21 	70-27262-00 AS 366 053 01 58 	4x 71-26283-00 ES 366 053 00 58 4x			
OM 364 OM 364 LA	OM 364.900 OM 364.907 OM 364.918 OM 364.955 OM 364.982 OM 364.985	4 Cyl.	01-26305-02 	02-26305-02 364 010 40 20 +346 017 01 60 (6x) +016 997 82 48 (6x) 	08-25508-08 364 010 22 08 		61-26305-60 364 016 07 20 98,5 Ø 1,3 mm 	14-32063-01 366 990 03 01 (17x) 	71-26306-30 364 016 01 21 	70-27262-00 AS 366 053 01 58 	4x 71-26323-30 I 2x 366 141 05 80 71-26283-00 3x 366 142 04 80	10-13034-01 364 010 01 80 	81-20504-40 K 014 997 16 47 65x90 A FIL RD FPM 71-24488-10 K 001 997 41 41 (2x)	
OM 364	OM 374.905 OM 380.940 OM 380.942 OM 380.943 OM 384.906	4 Cyl.	01-26305-02 	02-26305-02 364 010 40 20 +346 017 01 60 (6x) +016 997 82 48 (6x) 	08-25508-08 364 010 22 08 		61-26305-60 364 016 07 20 98,5 Ø 1,3 mm 		71-26306-30 364 016 01 21 	70-27262-00 AS 366 053 01 58 	4x 71-26283-00 ES 366 053 00 58 4x	71-26323-30 I 2x 366 141 05 80 71-26283-00 3x 366 142 04 80	10-13034-01 364 010 01 80 	
OM 364 LA	OM 354.900 OM 354.920 OM 354.921 OM 354.922	4 Cyl.		02-26305-04 364 010 53 20 +346 017 01 60 (4x) +016 997 82 48 (4x) 	08-25508-08 364 010 22 08 		61-26305-60 364 016 07 20 98,5 Ø 1,3 mm 	14-32063-01 366 990 03 01 (17x) 	71-26306-30 364 016 01 21 	70-27262-00 AS 366 053 01 58 	4x 71-26283-00 ES 366 053 00 58 4x	71-26323-20 I 2x 366 141 10 80 71-26283-00 3x 366 142 04 80	10-26637-03 314 010 25 27 	81-20504-40 K 014 997 16 47 65x90 A FIL RD FPM 71-24488-10 K 001 997 41 41 (2x)

MERCEDES-BENZ												
OM 364 LA	OM 374.992	4 Cyl.	<p>02-26305-04 364 010 53 20 +346 017 01 60 (4x) +016 997 82 48 (4x)</p> 	<p>08-25508-08 364 010 22 08</p> 		<p>61-26305-60 364 016 07 20 98,5 Ø 1,3 mm</p> 		<p>71-26306-30 364 016 01 21</p> 	<p>70-27262-00 AS 4x 366 053 01 58</p>  <p>70-27283-00 ES 4x 366 053 00 58</p> 	<p>71-26323-20 2x 366 141 10 80</p>  <p>71-26283-00 3x 366 142 04 80</p> 		
M 366 G M 366 LAG	M 376.925 M 376.926 M 376.927 M 376.929.005	6 Cyl.				<p>61-27350-40 366 016 06 20 98,5 Ø 1,3 mm</p> 	<p>14-32063-02 366 990 03 01 (25x)</p> 		<p>12-10001-02</p>     <p>70-27262-00 AS 6x 366 053 01 58</p>  <p>70-27283-00 ES 6x 366 053 00 58</p> 	<p>71-26323-30 3x 366 141 05 80</p>  <p>71-26283-00 4x 366 142 04 80</p> 	<p>10-12413-02 352 010 08 80</p>  <p>71-13055-00 366 010 06 80</p> 	<p>81-20504-40 K 014 997 16 47 65x90 A FIL RD FPM</p>  <p>71-24488-10 K 001 997 41 41 (2x)</p> 

MERCEDES-BENZ

													
OM 366 OM 366 A OM 366 LA	OM 356.901 OM 356.902 OM 356.904 OM 356.905 OM 356.906 OM 356.907 OM 356.908 OM 356.910 OM 356.911 OM 356.913 OM 356.915 OM 356.916 OM 356.940 OM 356.943 OM 356.958 OM 356.984 OM 356.987 OM 357.904 OM 357.915 OM 366.905 OM 366.906 OM 366.907 OM 366.909 OM 366.910 OM 366.911 OM 366.913 OM 366.914 OM 366.917 OM 366.919 OM 366.930 OM 366.932 OM 366.933 OM 366.935 OM 366.936 OM 366.938 OM 366.940 OM 366.951 OM 366.952 OM 366.955 OM 366.957 OM 366.960 OM 366.965 OM 366.981 OM 366.983 OM 366.990 OM 366.996	6 Cyl.	01-27350-07 	02-27350-04 366 010 61 20 +346 017 01 60 (6x) +016 997 82 48 (6x) 	08-25508-07 366 010 44 08 		61-27350-40 366 016 06 20 98,5 Ø 1,3 mm 	14-32063-02 366 990 03 01 (25x) 	71-26284-30 366 016 03 21 	70-27262-00 AS 6x 366 053 01 58  70-27283-00 ES 6x 366 053 00 58 	71-26323-30 3x 366 141 05 80  71-26283-00 4x 366 142 04 80 	10-12413-02 352 010 08 80  71-13055-00 366 010 06 80 	81-20504-40 K 014 997 16 47 65x90 A FIL RD FPM  71-24488-10 K 001 997 41 41 (2x) 
OM 366 OM 366 A OM 366 LA	OM 356.912 OM 356.914 OM 356.950 OM 356.952 OM 356.954 OM 356.955 OM 356.956 OM 356.957 OM 356.981 OM 356.997 OM 356.998 OM 357.912 OM 357.913	6 Cyl.		02-27350-04 366 010 61 20 +346 017 01 60 (6x) +016 997 82 48 (6x) 	08-25508-09 366 010 42 08 		61-27350-40 366 016 06 20 98,5 Ø 1,3 mm 	14-32063-02 366 990 03 01 (25x) 	71-26284-30 366 016 03 21 	70-27262-00 AS 6x 366 053 01 58  70-27283-00 ES 6x 366 053 00 58 	71-26323-30 3x 366 141 05 80  71-26283-00 4x 366 142 04 80 	71-13057-00 352 010 22 80 	81-20504-40 K 014 997 16 47 65x90 A FIL RD FPM  71-24488-10 K 001 997 41 41 (2x) 

MERCEDES-BENZ

<p>OM 366 OM 366 A OM 366 LA</p> <p>OM 356.944 OM 356.946 OM 356.948 OM 356.949 OM 356.951 OM 356.953 OM 356.990 OM 357.900 OM 357.901 OM 357.902 OM 357.903 OM 357.908 OM 357.916 OM 357.917 OM 357.918 OM 357.919 OM 357.963 OM 366.941 OM 366.942 OM 366.943 OM 366.945 OM 366.946 OM 366.953 OM 366.962 OM 366.967 OM 366.968 OM 366.969 OM 366.970 OM 366.971 OM 366.973 OM 366.975 OM 366.993 OM 366.994 OM 366.995 OM 376.905 OM 376.906 OM 376.907 OM 376.908 OM 376.909 OM 376.910 OM 376.930</p>	<p>01-27350-07</p>	<p>02-27350-04</p> <p>366 010 61 20 +346 017 01 60 (6x) +016 997 82 48 (6x)</p>	<p>08-25508-07</p> <p>366 010 44 08</p>	<p>04-10070-01</p>	<p>61-27350-40</p> <p>366 016 06 20 98,5 Ø 1,3 mm</p>	<p>14-32063-02</p> <p>366 990 03 01 (25x)</p>	<p>71-26284-30</p> <p>366 016 03 21</p>	<p>70-27262-00 AS</p> <p>366 053 01 58</p> <p>6x</p> <p>70-27283-00 ES</p> <p>366 053 00 58</p> <p>6x</p>	<p>71-26323-30</p> <p>366 141 05 80</p> <p>3x</p> <p>71-26283-00</p> <p>366 142 04 80</p> <p>4x</p>	<p>10-12413-02</p> <p>352 010 08 80</p> <p>71-13055-00</p> <p>366 010 06 80</p>	<p>81-20504-40 K</p> <p>014 997 16 47 65x90 A FIL RD FPM</p> <p>71-24488-10 K</p> <p>001 997 41 41 (2x)</p>
<p>OM 366 OM 366 A OM 366 LA</p> <p>OM 366.908 OM 366.912 OM 366.915 OM 366.939 OM 366.947 OM 366.948 OM 366.949 OM 366.954 OM 366.956 OM 366.958 OM 366.963 OM 366.977 OM 366.984</p>		<p>02-27350-04</p> <p>366 010 61 20 +346 017 01 60 (6x) +016 997 82 48 (6x)</p>	<p>08-25508-07</p> <p>366 010 44 08</p>		<p>61-27350-40</p> <p>366 016 06 20 98,5 Ø 1,3 mm</p>	<p>14-32063-02</p> <p>366 990 03 01 (25x)</p>	<p>71-26284-30</p> <p>366 016 03 21</p>	<p>70-27262-00 AS</p> <p>366 053 01 58</p> <p>6x</p> <p>70-27283-00 ES</p> <p>366 053 00 58</p> <p>6x</p>	<p>71-26323-30</p> <p>366 141 05 80</p> <p>3x</p> <p>71-26283-00</p> <p>366 142 04 80</p> <p>4x</p>	<p>71-13057-00</p> <p>352 010 22 80</p>	<p>81-20504-40 K</p> <p>014 997 16 47 65x90 A FIL RD FPM</p> <p>71-24488-10 K</p> <p>001 997 41 41 (2x)</p>
<p>OM 366 OM 366 LA</p> <p>OM 356.903 OM 356.909 OM 356.985 OM 366.918 OM 366.931 OM 366.937</p>	<p>01-27350-08</p>	<p>02-27350-04</p> <p>366 010 61 20 +346 017 01 60 (6x) +016 997 82 48 (6x)</p>	<p>08-25508-07</p> <p>366 010 44 08</p>		<p>61-27350-40</p> <p>366 016 06 20 98,5 Ø 1,3 mm</p>	<p>14-32063-02</p> <p>366 990 03 01 (25x)</p>	<p>71-26284-30</p> <p>366 016 03 21</p>	<p>70-27262-00 AS</p> <p>366 053 01 58</p> <p>6x</p> <p>70-27283-00 ES</p> <p>366 053 00 58</p> <p>6x</p>	<p>71-26323-30</p> <p>366 141 05 80</p> <p>3x</p> <p>71-26283-00</p> <p>366 142 04 80</p> <p>4x</p>	<p>71-13055-00</p> <p>366 010 06 80</p>	<p>81-20504-40 K</p> <p>014 997 16 47 65x90 A FIL RD FPM</p> <p>71-24488-10 K</p> <p>001 997 41 41 (2x)</p>

MERCEDES-BENZ

OM 366 A
OM 366 LA

OM 356.941
OM 356.945
OM 356.947
OM 356.959
OM 356.986
OM 356.992
OM 356.994
OM 356.995
OM 357.906
OM 357.907
OM 357.909
OM 357.910
OM 366.944
OM 366.966
OM 366.974
OM 366.976
OM 366.978
OM 366.979

6 Cyl.













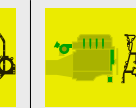

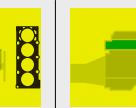

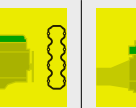
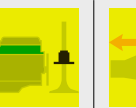
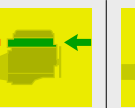

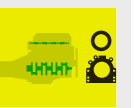
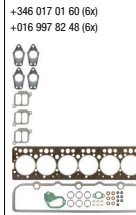
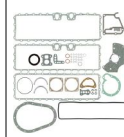
<p>01-27350-08</p>	<p>02-27350-04</p> <p>366 010 61 20 +346 017 01 60 (6x) +016 997 82 48 (6x)</p>	<p>08-25508-07</p> <p>366 010 44 08</p>	<p>04-10070-01</p>	<p>61-27350-40</p> <p>366 016 06 20 98,5 Ø 1,3 mm</p>	<p>14-32063-02</p> <p>366 990 03 01 (25x)</p>	<p>71-26284-30</p> <p>366 016 03 21</p>	<p>70-27262-00 AS 6x</p> <p>366 053 01 58</p> <p>70-27283-00 ES 6x</p> <p>366 053 00 58</p>	<p>71-26323-30 3x</p> <p>366 141 05 80</p> <p>71-26283-00 4x</p> <p>366 142 04 80</p>	<p>71-13055-00</p> <p>366 010 06 80</p>	<p>81-20504-40 K</p> <p>014 997 16 47 65x90 A FIL RD FPM</p> <p>71-24488-10 K</p> <p>001 997 41 41 (2x)</p>

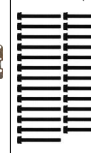
MERCEDES-BENZ

OM 366 A
OM 366 LA

OM 356.978
OM 357.925
OM 357.926
OM 357.931
OM 357.936
OM 357.937
OM 357.949
OM 376.941
OM 376.945
OM 376.946
OM 376.947
OM 376.950
OM 376.951
OM 376.952
OM 376.953
OM 376.954
OM 376.955
OM 376.956
OM 376.957
OM 376.958
OM 376.961
OM 376.962
OM 376.963
OM 376.964
OM 376.967
OM 376.968
OM 376.969
OM 376.970
OM 376.972
OM 376.975
OM 376.976
OM 376.977
OM 376.980
OM 376.981
OM 376.982
OM 376.984
OM 376.986
OM 376.987
OM 376.988
OM 376.989
OM 376.993
OM 376.994
OM 376.995
OM 376.997
OM 376.998
OM 376.999
OM 377.940
OM 377.941
OM 377.942
OM 377.943
OM 377.944
OM 377.945
OM 377.960
OM 377.961
OM 377.962
OM 377.963
OM 377.964
OM 377.967
OM 377.968
OM 377.969
OM 377.972
OM 377.973
OM 377.980
OM 377.981
OM 377.982
OM 377.983
OM 377.984
OM 377.985

6 Cyl.

											
		<p>02-27350-06 366 010 71 20 +346 017 01 60 (6x) +016 997 82 48 (6x)</p> 	<p>08-25508-07 366 010 44 08</p> 	<p>61-27350-40 366 016 06 20 98,5 Ø 1,3 mm</p> 	<p>14-32063-02 366 990 03 01 (25x)</p> 	<p>71-26284-30 366 016 03 21</p> 	<p>70-27262-00 AS 6x 366 053 01 58</p>  <p>70-27283-00 ES 6x 366 053 00 58</p> 	<p>71-26323-20 3x 366 141 10 80</p>  <p>71-26283-00 4x 366 142 04 80</p> 		<p>81-20504-40 K 014 997 16 47 65x90 A FIL RD FPM</p>  <p>71-24488-10 K 001 997 41 41 (2x)</p> 	

MERCEDES-BENZ													
OM 366 LA	OM 356.979 OM 356.999	6 Cyl.	 01-27350-07	 02-27350-06 366 010 71 20 +346 017 01 60 (6x) +016 997 82 48 (6x)	 08-25508-07 366 010 44 08	 04-10070-01 (H)	 61-27350-40 366 016 06 20 98,5 Ø 1,3 mm	 14-32063-02 366 990 03 01 (25x)	 71-26284-30 366 016 03 21	 70-27262-00 AS 366 053 01 58 6x	 71-26323-20 (L) → 366 141 10 80 3x	 10-12413-02 352 010 08 80	 81-20504-40 K ↔ 014 997 16 47 65x90 A FIL RD FPM 71-24488-10 K ↔ 001 997 41 41 (2x)
OM 366 LA	OM 356.980 OM 357.924 OM 357.945	6 Cyl.		 02-27350-06 366 010 71 20 +346 017 01 60 (6x) +016 997 82 48 (6x)	 08-25508-09 366 010 42 08		 61-27350-40 366 016 06 20 98,5 Ø 1,3 mm	 14-32063-02 366 990 03 01 (25x)	 71-26284-30 366 016 03 21	 70-27262-00 AS 366 053 01 58 6x	 71-26323-20 (L) → 366 141 10 80 3x	 71-13057-00 352 010 22 80	 81-20504-40 K ↔ 014 997 16 47 65x90 A FIL RD FPM 71-24488-10 K ↔ 001 997 41 41 (2x)
OM 366 LA	OM 356.989 OM 356.991 OM 357.920 OM 357.921 OM 357.922 OM 357.927 OM 357.929 OM 357.930 OM 357.932 OM 357.933 OM 357.942	6 Cyl.		 02-27350-06 366 010 71 20 +346 017 01 60 (6x) +016 997 82 48 (6x)	 08-25508-07 366 010 44 08	 04-10070-01 (H)	 61-27350-40 366 016 06 20 98,5 Ø 1,3 mm	 14-32063-02 366 990 03 01 (25x)	 71-26284-30 366 016 03 21	 70-27262-00 AS 366 053 01 58 6x	 71-26323-20 (L) → 366 141 10 80 3x		 81-20504-40 K ↔ 014 997 16 47 65x90 A FIL RD FPM 71-24488-10 K ↔ 001 997 41 41 (2x)
OM 366 LA	OM 357.940 OM 357.941 OM 357.943 OM 357.944 OM 357.947 OM 357.948	6 Cyl.		 02-27350-06 366 010 71 20 +346 017 01 60 (6x) +016 997 82 48 (6x)	 08-25508-07 366 010 44 08	 04-10070-01 (H) ↔ 450528	 61-27350-40 366 016 06 20 98,5 Ø 1,3 mm	 14-32063-02 366 990 03 01 (25x)	 71-26284-30 366 016 03 21	 70-27262-00 AS 366 053 01 58 6x	 71-26323-20 (L) → 366 141 10 80 3x		 81-20504-40 K ↔ 014 997 16 47 65x90 A FIL RD FPM 71-24488-10 K ↔ 001 997 41 41 (2x)
OM 366 LA	OM 357.946	6 Cyl.		 02-27350-06 366 010 71 20 +346 017 01 60 (6x) +016 997 82 48 (6x)	 08-25508-07 366 010 44 08	 04-10070-01 (H) ↔ 450529 →	 61-27350-40 366 016 06 20 98,5 Ø 1,3 mm	 14-32063-02 366 990 03 01 (25x)	 71-26284-30 366 016 03 21	 70-27262-00 AS 366 053 01 58 6x	 71-26323-20 (L) → 366 141 10 80 3x	 10-12413-02 352 010 08 80	 81-20504-40 K ↔ 014 997 16 47 65x90 A FIL RD FPM 71-24488-10 K ↔ 001 997 41 41 (2x)

MERCEDES-BENZ												
OM 366 LA	OM 357.961 OM 357.962	6 Cyl.										
			02-27350-06 366 010 71 20 +346 017 01 60 (6x) +016 997 82 48 (6x)	08-25508-07 366 010 44 08	04-10070-01 366 010 44 08	61-27350-40 366 016 06 20 98,5 Ø 1,3 mm	14-32063-02 366 990 03 01 (25x)	71-26284-30 366 016 03 21	70-27262-00 AS 6x 366 053 01 58	71-26323-30 3x 366 141 05 80	81-20504-40 K 014 997 16 47 65x90 A FIL RD FPM	
			02-27350-04 366 010 61 20 +346 017 01 60 (6x) +016 997 82 48 (6x)	08-25508-07 366 010 44 08	04-10070-01 023164	61-27350-40 366 016 06 20 98,5 Ø 1,3 mm	14-32063-02 366 990 03 01 (25x)	71-26284-30 366 016 03 21	70-27262-00 AS 6x 366 053 01 58	71-26323-30 3x 366 141 05 80	81-20504-40 K 014 997 16 47 65x90 A FIL RD FPM	
			02-27350-04 366 010 61 20 +346 017 01 60 (6x) +016 997 82 48 (6x)	08-25508-07 366 010 44 08	04-10070-01 023165→	61-27350-40 366 016 06 20 98,5 Ø 1,3 mm	14-32063-02 366 990 03 01 (25x)	71-26284-30 366 016 03 21	70-27262-00 AS 6x 366 053 01 58	71-26323-30 3x 366 141 05 80	81-20504-40 K 014 997 16 47 65x90 A FIL RD FPM	
			02-27350-04 366 010 61 20 +346 017 01 60 (6x) +016 997 82 48 (6x)	08-25508-07 366 010 44 08	04-10070-01 023165→	61-27350-40 366 016 06 20 98,5 Ø 1,3 mm	14-32063-02 366 990 03 01 (25x)	71-26284-30 366 016 03 21	70-27262-00 AS 6x 366 053 01 58	71-26323-30 3x 366 141 05 80	81-20504-40 K 014 997 16 47 65x90 A FIL RD FPM	
			02-27350-06 366 010 71 20 +346 017 01 60 (6x) +016 997 82 48 (6x)			61-27350-40 366 016 06 20 98,5 Ø 1,3 mm	14-32063-02 366 990 03 01 (25x)	71-26284-30 366 016 03 21	70-27262-00 AS 6x 366 053 01 58	71-26323-30 3x 366 141 05 80	81-20504-40 K 014 997 16 47 65x90 A FIL RD FPM	
			02-27350-04 366 010 61 20 +346 017 01 60 (6x) +016 997 82 48 (6x)			61-27350-40 366 016 06 20 98,5 Ø 1,3 mm	14-32063-02 366 990 03 01 (25x)	71-26284-30 366 016 03 21	70-27262-00 AS 6x 366 053 01 58	71-26323-30 3x 366 141 05 80	81-20504-40 K 014 997 16 47 65x90 A FIL RD FPM	
			02-27350-04 366 010 61 20 +346 017 01 60 (6x) +016 997 82 48 (6x)			61-27350-40 366 016 06 20 98,5 Ø 1,3 mm	14-32063-02 366 990 03 01 (25x)	71-26284-30 366 016 03 21	70-27262-00 AS 6x 366 053 01 58	71-26323-30 3x 366 141 05 80	81-20504-40 K 014 997 16 47 65x90 A FIL RD FPM	

MERCEDES-BENZ

OM 401
OM 401 A
OM 401 LA
OM 401 (RAM-Air)

OM 401.900
OM 401.901
OM 401.905
OM 401.906
OM 401.907
OM 401.908
OM 401.909
OM 401.912
OM 401.913
OM 401.914
OM 401.915
OM 401.916
OM 401.917
OM 401.918
OM 401.919
OM 401.921
OM 401.922
OM 401.923
OM 401.924
OM 401.925
OM 401.926
OM 401.927
OM 401.928

6 Cyl.

<p>01-25105-30</p>	<p>03-25105-09 </p> <p>423 010 04 20 ➔ 001206</p> <p>03-25105-08</p> <p>444 010 01 20 +422 053 01 96 (2x) ➔ 001207➔</p> <p>03-25105-11</p> <p>444 010 01 20 ➔ 001207➔</p> <p>03-25105-12</p> <p>➔ 001207➔</p>	<p>08-23922-04</p> <p>421 010 04 08</p>	<p>15-25799-02 </p> <p>423 010 48 33</p> <p>15-28490-01 </p> <p>442 011 00 59 +025 997 84 48 +025 997 85 48 (2x)</p> <p>15-76929-01 </p> <p>6x 009 997 88 48 (2x) +012 997 71 48 (2x)</p> <p>15-76930-01 </p> <p>6x 025 997 84 48 (2x) +025 997 85 48 (2x)</p>	<p>61-25105-15 6x</p> <p>422 016 04 20 144 Ø 1,25 mm</p> <p>61-25105-55 6x</p> <p>422 016 04 20 144 Ø 1,25 mm MLS</p>	<p>14-32060-01 6x</p> <p>422 990 02 01 (1x) +422 990 03 01 (3x) +422 990 04 01 (2x)</p>	<p>71-22992-00</p> <p>403 016 01 21 ➔ 001206</p> <p>71-23906-20</p> <p>442 016 07 21 ➔ 001207➔</p>	<p>70-23096-10 12x</p> <p>422 053 01 96</p>	<p>71-26069-20 </p> <p>6x 442 141 17 80</p> <p>71-23079-00 </p> <p>6x 403 142 03 80</p> <p>71-09752-20 </p> <p>16 066 492 00 80</p>	<p>71-23922-10</p> <p>441 014 00 22</p>	<p>81-23301-60 </p> <p>014 997 46 47 105x130 A FIL RD FPM</p> <p>81-23113-00 </p> <p>013 997 14 47 120x140 AB SL LD FPM</p>

MERCEDES-BENZ

OM 401 LA
 OM 441
 OM 441 A
 OM 441 LA

6 Cyl.

OM 401.972
 OM 401.973
 OM 401.975
 OM 401.977
 OM 401.978
 OM 401.979
 OM 401.980
 OM 401.981
 OM 401.984
 OM 401.985
 OM 401.986
 OM 401.987
 OM 401.989
 OM 401.990
 OM 401.991
 OM 401.993
 OM 401.994
 OM 441.901
 OM 441.951
 OM 441.952
 OM 441.960
 OM 441.961
 OM 441.962
 OM 441.981
 OM 441.982
 OM 441.983
 OM 441.985
 OM 441.986
 OM 441.987
 OM 441.988
 OM 441.989
 OM 441.990
 OM 441.991
 OM 441.992
 OM 441.993
 OM 441.994
 OM 441.995
 OM 441.996
 OM 441.997
 OM 441.998
 OM 441.999
 OM 445.920
 OM 445.921
 OM 445.922
 OM 445.923
 OM 445.924
 OM 445.925
 OM 445.926
 OM 445.927
 OM 445.929
 OM 445.930
 OM 445.931
 OM 445.933
 OM 445.936
 OM 445.937
 OM 445.938
 OM 445.939
 OM 445.940
 OM 445.941

01-25105-38 	03-25105-08 444 010 01 20 +422 053 01 96 (2x) 03-25105-11 444 010 01 20 03-25105-12 	08-23922-04 421 010 04 08 	15-25799-02 423 010 48 33 15-28490-01 442 011 00 59 +025 997 84 48 +025 997 85 48 (2x) 	61-25105-15 6x 422 016 04 20 144 Ø 1,25 mm 61-25105-55 6x 422 016 04 20 144 Ø 1,25 mm MLS 	14-32060-01 6x 422 990 02 01 (1x) +422 990 03 01 (3x) +422 990 04 01 (2x) 	71-23906-20 6x 442 016 07 21 	70-23096-10 12x 422 053 01 96 	71-26069-20 442 141 17 80 71-23079-00 403 142 03 80 	71-23922-10 441 014 00 22 	81-23301-60 014 997 46 47 105x130 A FIL RD FPM 81-23113-00 013 997 14 47 120x140 AB SL LD FPM 		

MERCEDES-BENZ

OM 401 LA
OM 441 A
OM 441 LA

OM 401.970
OM 401.974
OM 441.950
OM 441.953
OM 441.980
OM 445.934
OM 445.935

6 Cyl.

<p>01-25105-38</p>	<p>03-25105-08 444 010 01 20 +422 053 01 96 (2x)</p>	<p>08-23922-04 421 010 04 08</p>	<p>04-10069-01 (1)</p>	<p>61-25105-15 6x 422 016 04 20 144 Ø 1,25 mm</p> <p>61-25105-55 6x 422 016 04 20 144 Ø 1,25 mm MLS</p>	<p>14-32060-01 6x 422 990 02 01 (1x) +422 990 03 01 (3x) +422 990 04 01 (2x)</p>	<p>71-23906-20 6x 442 016 07 21</p>	<p>70-23096-10 12x 422 053 01 96</p>	<p>71-26069-20 (1) 6x 442 141 17 80</p> <p>71-23079-00 (1) 6x 403 142 03 80</p>	<p>71-23922-10 441 014 00 22</p>	<p>81-23301-60 (1) 6x 014 997 46 47 105x130 A FIL RD FPM</p> <p>81-23113-00 (1) 6x 013 997 14 47 120x140 AB SL LD FPM</p>
	<p>03-25105-11 444 010 01 20</p>		<p>15-25799-02 (1) 423 010 48 33</p> <p>15-28490-01 (3) 6x 442 011 00 59 +025 997 84 48 +025 997 85 48 (2x)</p>							

MERCEDES-BENZ

OM 402
OM 402 LA

OM 402.900
OM 402.901
OM 402.905
OM 402.906
OM 402.907
OM 402.910
OM 402.911
OM 402.912
OM 402.913
OM 402.914
OM 402.916
OM 402.917
OM 402.919
OM 402.921
OM 402.923
OM 402.924
OM 402.925
OM 402.926
OM 402.927
OM 402.928

8 Cyl.

<p>01-25105-31</p>	<p>03-25105-09 </p> <p>423 010 04 20 013687</p> <p>03-25105-08</p> <p>444 010 01 20 +422 053 01 96 (2x) 013688→</p> <p>03-25105-11</p> <p>444 010 01 20 013688→</p> <p>03-25105-12</p>	<p>08-23443-05</p> <p>422 010 06 08</p>	<p>15-25799-02 </p> <p>423 010 48 33</p> <p>15-28490-01 </p> <p>442 011 00 59 +025 997 84 48 +025 997 85 48 (2x)</p> <p>15-76929-01 </p> <p>8x</p> <p>009 997 88 48 (2x) +012 997 71 48 (2x)</p> <p>15-76930-01 </p> <p>8x</p> <p>025 997 84 48 (2x) +025 997 85 48 (2x)</p>	<p>61-25105-15 8x</p> <p>422 016 04 20 144 Ø 1,25 mm</p> <p>61-25105-55 8x</p> <p>422 016 04 20 144 Ø 1,25 mm MLS</p>	<p>14-32060-01 8x</p> <p>422 990 02 01 (1x) +422 990 03 01 (3x) +422 990 04 01 (2x) 129661→</p>	<p>71-22992-00</p> <p>403 016 01 21 013687</p> <p>71-23906-20</p> <p>442 016 07 21 013688→</p>	<p>70-23096-10 16x</p> <p>422 053 01 96</p>	<p>71-26069-20 </p> <p>8x</p> <p>442 141 17 80</p> <p>71-23079-00 </p> <p>8x</p> <p>403 142 03 80</p> <p>71-09752-20 </p> <p>16</p> <p>066 492 00 80</p>	<p>71-23443-20</p> <p>442 014 00 22</p>	<p>81-23301-60 </p> <p>014 997 46 47 105x130 A FIL RD FPM</p> <p>81-23113-00 </p> <p>013 997 14 47 120x140 AB SL LD FPM</p>

MERCEDES-BENZ

OM 402 LA
OM 442 A
OM 442 LA

OM 402.970
OM 442.954
OM 442.955
OM 442.960
OM 442.961
OM 446.934
OM 446.938

8 Cyl.

<p>01-25105-40</p>	<p>03-25105-08 444 010 01 20 +422 053 01 96 (2x)</p>	<p>08-23443-05 422 010 06 08</p>	<p>04-10079-01 </p>	<p>61-25105-15 8x 422 016 04 20 144 Ø 1,25 mm</p> <p>61-25105-55 8x 422 016 04 20 144 Ø 1,25 mm MLS</p>	<p>14-32060-01 8x 422 990 02 01 (1x) +422 990 03 01 (3x) +422 990 04 01 (2x)</p>	<p>71-23906-20 8x 442 016 07 21</p>	<p>70-23096-10 16x 422 053 01 96</p>	<p>71-26069-20 8x 442 141 17 80</p> <p>71-23079-00 8x 403 142 03 80</p>	<p>71-23443-20 442 014 00 22</p>	<p>81-23301-60 014 997 46 47 105x130 A FIL RD FPM</p> <p>81-23113-00 013 997 14 47 120x140 AB SL LD FPM</p>
	<p>03-25105-11 444 010 01 20</p>		<p>15-25799-02 423 010 48 33</p>							
	<p>03-25105-12</p>		<p>15-28490-01 8x 442 011 00 59 +025 997 84 48 +025 997 85 48 (2x)</p>							

MERCEDES-BENZ

OM 402 LA
OM 442 A
OM 442 LA

OM 402.971
OM 402.972
OM 402.973
OM 402.974
OM 402.975
OM 402.977
OM 402.978
OM 402.982
OM 402.983
OM 402.984
OM 402.985
OM 402.986
OM 402.987
OM 402.989
OM 402.990
OM 402.995
OM 402.996
OM 440.940
OM 440.941
OM 440.942
OM 440.943
OM 440.945
OM 440.948
OM 440.949
OM 440.970
OM 440.971
OM 440.972
OM 440.973
OM 440.974
OM 440.975
OM 440.976
OM 440.978
OM 440.979
OM 440.980
OM 440.981
OM 440.982
OM 440.983
OM 440.984
OM 440.985
OM 440.986
OM 440.987
OM 440.988
OM 440.989
OM 440.990
OM 440.991
OM 442.901
OM 442.940
OM 442.941
OM 442.942
OM 442.943
OM 442.944
OM 442.945
OM 442.946
OM 442.950
OM 442.951
OM 442.952
OM 442.953
OM 442.957
OM 442.958
OM 442.959
OM 442.962
OM 442.963
OM 442.964
OM 442.965
OM 442.966
OM 442.967
OM 442.968
OM 442.969
OM 442.970
OM 442.971
OM 442.972
OM 442.973
OM 442.974
OM 442.975
OM 442.976
OM 442.977
OM 442.978
OM 442.979
OM 442.980
OM 442.982
OM 442.983

8 Cyl.

<p>01-25105-40</p>	<p>03-25105-08 444 010 01 20 +422 053 01 96 (2x)</p> <p>03-25105-11 444 010 01 20</p> <p>03-25105-12</p>	<p>08-23443-05 422 010 06 08</p>	<p>15-25799-02 423 010 48 33</p> <p>15-28490-01 442 011 00 59 +025 997 84 48 +025 997 85 48 (2x)</p>	<p>61-25105-15 8x 422 016 04 20 144 Ø 1,25 mm</p> <p>61-25105-55 8x 422 016 04 20 144 Ø 1,25 mm MLS</p>	<p>14-32060-01 8x 422 990 02 01 (1x) +422 990 03 01 (3x) +422 990 04 01 (2x)</p>	<p>71-23906-20 8x 442 016 07 21</p>	<p>70-23096-10 16x 422 053 01 96</p>	<p>71-26069-20 8x 442 141 17 80</p> <p>71-23079-00 8x 403 142 03 80</p>	<p>71-23443-20 442 014 00 22</p>	<p>81-23301-60 014 997 46 47 105x130 A FIL RD FPM</p> <p>81-23113-00 013 997 14 47 120x140 AB SL LD FPM</p>

MERCEDES-BENZ

OM 402 LA
OM 442 A
OM 442 LA

OM 442.984
OM 442.985
OM 442.989
OM 442.991
OM 442.992
OM 442.993
OM 442.994
OM 442.995
OM 442.996
OM 442.997
OM 442.998
OM 442.999
OM 446.920
OM 446.922
OM 446.923
OM 446.924
OM 446.925
OM 446.926
OM 446.927
OM 446.928
OM 446.929
OM 446.930
OM 446.931
OM 446.932
OM 446.933
OM 446.935
OM 446.936
OM 446.939
OM 446.940
OM 446.941
OM 446.942
OM 446.943
OM 446.944
OM 446.945
OM 446.946
OM 446.947
OM 446.948

8 Cyl.

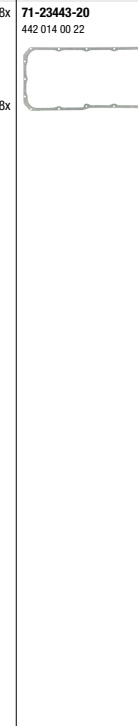
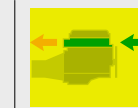
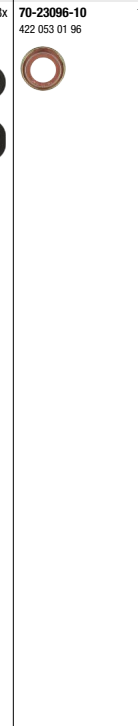
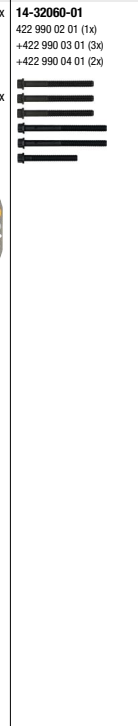
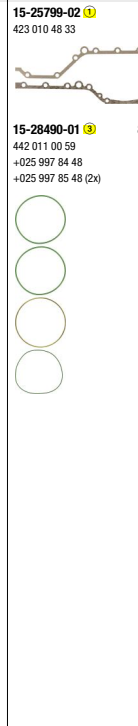
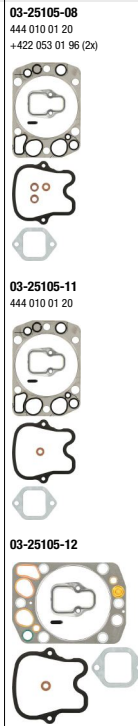

OM 403
OM 403.900
OM 403.905
OM 403.906

10 Cyl.

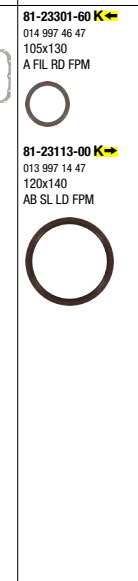
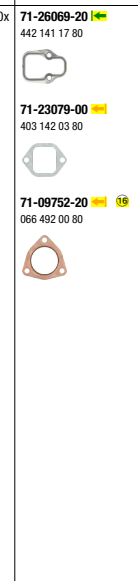
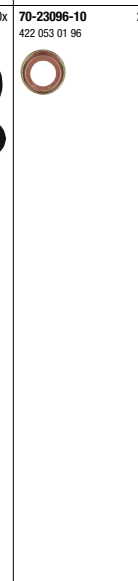
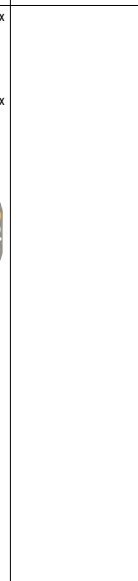
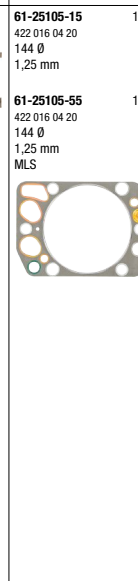
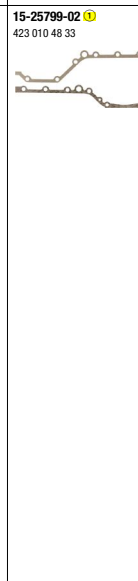
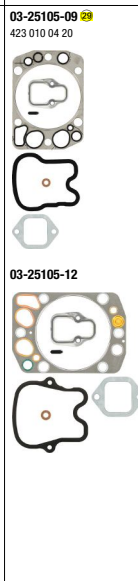

MERCEDES-BENZ

OM 403 10 Cyl.



- OM 403.910
- OM 403.915
- OM 403.916
- OM 403.917
- OM 403.918
- OM 403.919
- OM 403.930
- OM 403.931
- OM 403.932
- OM 403.933
- OM 403.934
- OM 403.935

<p>01-25105-32</p>	<p>03-25105-09 </p> <p>423 010 04 20 ➔ 022607</p> <p>03-25105-08</p> <p>444 010 01 20 +422 053 01 96 (2x) ➔ 022608➔</p> <p>03-25105-11</p> <p>444 010 01 20 ➔ 022608➔</p> <p>03-25105-12</p>	<p>08-23347-04</p> <p>423 010 06 08</p>	<p>15-25799-02 </p> <p>423 010 48 33</p> <p>15-28490-01 </p> <p>442 011 00 59 10x +025 997 84 48 +025 997 85 48 (2x)</p> <p>15-76929-01 </p> <p>009 997 88 48 (2x) 10x +012 997 71 48 (2x)</p> <p>15-76930-01 </p> <p>025 997 84 48 (2x) 10x +025 997 85 48 (2x)</p>	<p>61-25105-15 10x</p> <p>422 016 04 20 144 Ø 1,25 mm</p> <p>61-25105-55 10x</p> <p>422 016 04 20 144 Ø 1,25 mm MLS</p>	<p>14-32060-01 10x</p> <p>422 990 02 01 (1x) +422 990 03 01 (3x) +422 990 04 01 (2x) ➔ 129761➔</p>	<p>71-22992-00 10x</p> <p>403 016 01 21 ➔ 022607</p> <p>71-23906-20</p> <p>442 016 07 21 ➔ 022608➔</p>	<p>70-23096-10 20x</p> <p>422 053 01 96</p>	<p>71-26069-20 </p> <p>442 141 17 80 10x</p> <p>71-23079-00 </p> <p>403 142 03 80 10x</p> <p>71-09752-20 </p> <p>066 492 00 80 </p>	<p>71-23347-20</p> <p>443 014 00 22</p>	<p>81-23301-60 </p> <p>014 997 46 47 105x130 A FIL RD FPM</p> <p>81-23113-00 </p> <p>013 997 14 47 120x140 AB SL LD FPM</p>
---------------------------	--	--	--	---	---	--	--	--	--	---

MERCEDES-BENZ

OM 407
OM 407 A
OM 407 H
OM 407 HA
OM 407 LA

6 Cyl.

<p>01-25105-34 </p>	<p>03-25105-09 423 010 04 20 002809 </p> <p>03-25105-08 444 010 01 20 +422 053 01 96 (2x) 002810→ </p> <p>03-25105-11 444 010 01 20 002810→ </p> <p>03-25105-12 </p>	<p>08-23601-04 407 010 23 08 </p>	<p>15-28490-01 6x 442 011 00 59 +025 997 84 48 +025 997 85 48 (2x) </p> <p>15-76929-01 6x 009 997 88 48 (2x) +012 997 71 48 (2x) </p> <p>15-76930-01 6x 025 997 84 48 (2x) +025 997 85 48 (2x) </p>	<p>61-25105-15 6x 422 016 04 20 144 Ø 1,25 mm </p> <p>61-25105-55 6x 422 016 04 20 144 Ø 1,25 mm MLS </p>	<p>14-32060-01 6x 422 990 02 01 (1x) +422 990 03 01 (3x) +422 990 04 01 (2x) 017498→ </p>	<p>71-22992-00 403 016 01 21 002809 </p> <p>71-23906-20 442 016 07 21 002810→ </p>	<p>70-23096-10 12x 422 053 01 96 </p>	<p>71-26069-20 6x 442 141 17 80 </p> <p>71-23079-00 6x 403 142 03 80 </p> <p>71-09752-20 16 066 492 00 80 </p>	<p>71-23601-10 447 014 00 22 </p>	<p>81-23301-60 014 997 46 47 105x130 A FIL RD FPM </p> <p>81-23113-00 013 997 14 47 120x140 AB SL LD FPM </p>

MERCEDES-BENZ

OM 407 H
 OM 407.913
 OM 407.914
 OM 407.915
 OM 407.916
 OM 407.917
 OM 407.918
 OM 407.919













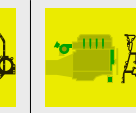

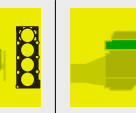
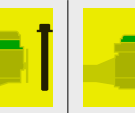
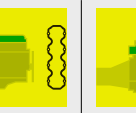
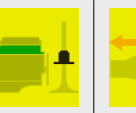
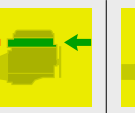

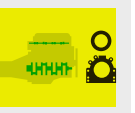

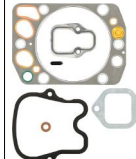
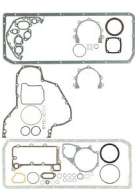

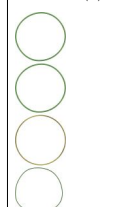

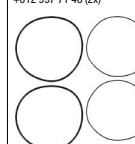

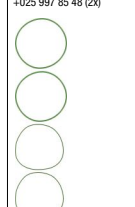

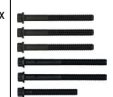

<p>01-25105-34 ↳ 002809</p>	<p>03-25105-09 Ⓜ ↳ 002809</p>	<p>08-23601-04 407 010 23 08</p>	<p>15-28490-01 Ⓜ 6x 442 011 00 59 +025 997 84 48 +025 997 85 48 (2x)</p>	<p>61-25105-15 6x 422 016 04 20 144 Ø 1,25 mm</p> <p>61-25105-55 6x 422 016 04 20 144 Ø 1,25 mm MLS</p>	<p>14-32060-01 6x 422 990 02 01 (1x) +422 990 03 01 (3x) +422 990 04 01 (2x) ↳ 017498→</p>	<p>71-22992-00 6x 403 016 01 21 ↳ 002809</p>	<p>71-23906-20 442 016 07 21 ↳ 002810→</p>	<p>70-23096-10 12x 422 053 01 96</p>	<p>71-26069-20 Ⓜ 6x 442 141 17 80</p> <p>71-23079-00 Ⓜ 6x 403 142 03 80</p> <p>71-09752-20 Ⓜ 16 066 492 00 80</p>	<p>71-23601-10 447 014 00 22</p>	<p>81-23301-60 Ⓜ 014 997 46 47 105x130 A FIL RD FPM</p> <p>81-23113-00 Ⓜ 013 997 14 47 120x140 AB SL LD FPM</p>

MERCEDES-BENZ

OM 409
OM 429
OM 429 LA

OM 409.906
OM 409.907
OM 409.908
OM 429.951
OM 429.952
OM 429.953
OM 429.955

5 Cyl.

											
		<p>03-25105-08 444 010 01 20 +422 053 01 96 (2x)</p>  <p>03-25105-11 444 010 01 20</p>  <p>03-25105-12</p> 	<p>08-26363-02 409 010 12 08</p> 	<p>15-28490-01  5x 442 011 00 59 +025 997 84 48 +025 997 85 48 (2x)</p>  <p>15-76929-01  5x 009 997 88 48 (2x) +012 997 71 48 (2x)</p>  <p>15-76930-01  5x 025 997 84 48 (2x) +025 997 85 48 (2x)</p> 	<p>61-25105-15 5x 422 016 04 20 144 Ø 1,25 mm</p> <p>61-25105-55 5x 422 016 04 20 144 Ø 1,25 mm MLS</p> 	<p>14-32060-01 5x 422 990 02 01 (1x) +422 990 03 01 (3x) +422 990 04 01 (2x)  017579→</p> 	<p>71-23906-20 5x 442 016 07 21</p> 	<p>70-23096-10 10x 422 053 01 96</p> 	<p>71-26069-20  5x 442 141 17 80</p>  <p>71-23079-00  5x 403 142 03 80</p> 	<p>71-23603-10 449 014 00 22</p> 	<p>81-23301-60  014 997 46 47 105x130 A FIL RD FPM</p>  <p>81-23113-00  013 997 14 47 120x140 AB SL LD FPM</p> 

MERCEDES-BENZ

OM 421
OM 421 A
OM 481

OM 421.901
OM 421.905
OM 421.906
OM 421.907
OM 421.908
OM 421.909
OM 421.910
OM 421.951
OM 481.902
OM 481.904

6 Cyl.

<p>01-25105-35</p>	<p>03-25105-08 444 010 01 20 +422 053 01 96 (2x)</p> <p>03-25105-11 444 010 01 20</p> <p>03-25105-12</p>	<p>08-23922-04 421 010 04 08</p>	<p>15-25799-02 </p> <p>423 010 48 33</p> <p>15-28490-01 </p> <p>442 011 00 59 +025 997 84 48 +025 997 85 48 (2x)</p> <p>15-76930-01 </p> <p>025 997 84 48 (2x) +025 997 85 48 (2x)</p>	<p>61-25105-15 6x 422 016 04 20 144 Ø 1,25 mm</p> <p>61-25105-55 6x 422 016 04 20 144 Ø 1,25 mm MLS</p>	<p>14-32060-01 6x 422 990 02 01 (1x) +422 990 03 01 (3x) +422 990 04 01 (2x)</p>	<p>71-23906-20 6x 442 016 07 21</p>	<p>70-23096-10 12x 422 053 01 96</p>	<p>71-26069-20 6x 442 141 17 80</p> <p>71-23079-00 6x 403 142 03 80</p>	<p>71-23922-10 441 014 00 22</p>	<p>81-23301-60 </p> <p>014 997 46 47 105x130 A FIL RD FPM</p> <p>81-23113-00 </p> <p>013 997 14 47 120x140 AB SL LD FPM</p>

MERCEDES-BENZ

OM 422
 OM 422 A
 OM 422 LA
 OM 482

OM 422.901
 OM 422.905
 OM 422.906
 OM 422.907
 OM 422.908
 OM 422.909
 OM 422.910
 OM 422.911
 OM 422.912
 OM 422.913
 OM 422.914
 OM 422.915
 OM 422.916
 OM 422.917
 OM 422.918
 OM 422.919
 OM 422.920
 OM 422.921
 OM 422.922
 OM 422.923
 OM 422.950
 OM 422.952
 OM 422.953
 OM 422.954
 OM 422.955
 OM 422.956
 OM 422.957
 OM 422.958
 OM 422.959
 OM 482.912
 OM 482.930
 OM 482.940
 OM 482.941
 OM 492.900



01-25105-33
 444 010 01 20
 +422 053 01 96 (2x)



03-25105-08
 444 010 01 20
 +422 053 01 96 (2x)

03-25105-11
 444 010 01 20

03-25105-12



08-23443-05
 422 010 06 08



15-25799-02 ⓘ
 423 010 48 33

15-28490-01 ⓘ 8x
 442 011 00 59
 +025 997 84 48
 +025 997 85 48 (2x)

15-76930-01 ⓘ 8x
 025 997 84 48 (2x)
 +025 997 85 48 (2x)



61-25105-15 8x
 422 016 04 20
 144 Ø
 1,25 mm

61-25105-55 8x
 422 016 04 20
 144 Ø
 1,25 mm
 MLS



14-32060-01 8x
 422 990 02 01 (1x)
 +422 990 03 01 (3x)
 +422 990 04 01 (2x)



71-23906-20 8x
 442 016 07 21

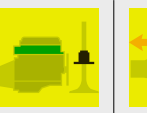

70-23096-10 16x
 422 053 01 96

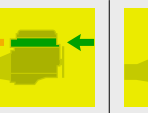

71-26069-20 ⓘ 8x
 442 141 17 80

71-23079-00 ⓘ 8x
 403 142 03 80



71-23443-20
 442 014 00 22



81-23301-60 K↔
 014 997 46 47
 105x130
 A FIL RD FPM

81-23113-00 K↔
 013 997 14 47
 120x140
 AB SL LD FPM

MERCEDES-BENZ

OM 422 A OM 422.951 8 Cyl.



OM 422.963

<p>01-25105-33 444 010 01 20 +422 053 01 96 (2x)</p>	<p>03-25105-08 444 010 01 20 +422 053 01 96 (2x)</p> <p>03-25105-11 444 010 01 20</p> <p>03-25105-12 025 997 84 48 (2x) +025 997 85 48 (2x)</p>	<p>08-23443-05 422 010 06 08</p> <p>15-25799-02 423 010 48 33</p> <p>15-28490-01 8x 442 011 00 59 +025 997 84 48 +025 997 85 48 (2x)</p> <p>15-76930-01 8x 025 997 84 48 (2x) +025 997 85 48 (2x)</p>	<p>04-10079-01 422 016 04 20 144 Ø 1,25 mm</p> <p>61-25105-15 8x 422 016 04 20 144 Ø 1,25 mm</p> <p>61-25105-55 8x 422 016 04 20 144 Ø 1,25 mm MLS</p>	<p>14-32060-01 8x 422 990 02 01 (1x) +422 990 03 01 (3x) +422 990 04 01 (2x)</p> <p>71-23906-20 8x 442 016 07 21</p>	<p>70-23096-10 16x 422 053 01 96</p>	<p>71-26069-20 8x 442 141 17 80</p> <p>71-23079-00 8x 403 142 03 80</p>	<p>71-23443-20 442 014 00 22</p>	<p>81-23301-60 014 997 46 47 105x130 A FIL RD FPM</p> <p>81-23113-00 013 997 14 47 120x140 AB SL LD FPM</p>		

MERCEDES-BENZ

OM 423
OM 423 LA
OM 423.901
OM 423.905
OM 423.906
OM 423.907
OM 423.908
OM 423.909
OM 423.950
OM 423.951

10 Cyl.

<p>01-25105-36 444 010 01 20 +422 053 01 96 (2x)</p>	<p>03-25105-08 444 010 01 20 +422 053 01 96 (2x)</p>	<p>08-23347-04 423 010 06 08</p>	<p>15-25799-02 10x 423 010 48 33</p>	<p>61-25105-15 10x 422 016 04 20 144 Ø 1,25 mm</p> <p>61-25105-55 10x 422 016 04 20 144 Ø 1,25 mm MLS</p>	<p>14-32060-01 10x 422 990 02 01 (1x) +422 990 03 01 (3x) +422 990 04 01 (2x)</p>	<p>71-23906-20 10x 442 016 07 21</p>	<p>70-23096-10 20x 422 053 01 96</p>	<p>71-26069-20 10x 442 141 17 80</p> <p>71-23079-00 10x 403 142 03 80</p>	<p>71-23347-20 443 014 00 22</p>	<p>81-23301-60 014 997 46 47 105x130 A FIL RD FPM</p> <p>81-23113-00 013 997 14 47 120x140 AB SL LD FPM</p>
<p>03-25105-11 444 010 01 20</p>	<p>03-25105-12</p>	<p>15-28490-01 10x 442 011 00 59 +025 997 84 48 +025 997 85 48 (2x)</p>	<p>15-76930-01 10x 025 997 84 48 (2x) +025 997 85 48 (2x)</p>							

MERCEDES-BENZ

<p>OM 424 OM 424 LA OM 444 A OM 444 LA</p>	<p>OM 424.900 OM 424.901 OM 424.901.510 OM 444.901 OM 444.901.400 OM 444.901.500 OM 444.901.501 OM 444.901.502 OM 444.901.504 OM 444.901.505 OM 444.901.506 OM 444.901.508 OM 444.901.520 OM 444.901.521</p>	<p>12 Cyl.</p>	<p>01-25105-44 </p>	<p>03-25105-08 444 010 01 20 +422 053 01 96 (2x) </p> <p>03-25105-11 444 010 01 20 </p> <p>03-25105-12 </p>	<p>08-26976-02 424 010 09 08 </p>	<p>15-25799-02 423 010 48 33 </p> <p>15-28490-01 442 011 00 59 12x +025 997 84 48 +025 997 85 48 (2x)</p> <p>15-76930-01 025 997 84 48 (2x) +025 997 85 48 (2x)</p>	<p>61-25105-15 12x 422 016 04 20 144 Ø 1,25 mm</p> <p>61-25105-55 12x 422 016 04 20 144 Ø 1,25 mm MLS </p>	<p>14-32060-01 12x 422 990 02 01 (1x) +422 990 03 01 (3x) +422 990 04 01 (2x) </p>	<p>71-23906-20 12x 442 016 07 21 </p>	<p>70-23096-10 24x 422 053 01 96 </p>	<p>71-26069-20 12x 442 141 17 80 </p> <p>71-23079-00 12x 403 142 03 80 </p>	<p>71-26976-10 444 014 00 22 </p>	<p>81-23301-60 014 997 46 47 105x130 A FIL RD FPM </p> <p>81-23113-00 013 997 14 47 120x140 AB SL LD FPM </p>
<p>OM 427 OM 427 A OM 427 H OM 427 HA</p>	<p>OM 427.900 OM 427.901 OM 427.902 OM 427.903 OM 427.905 OM 427.910 OM 427.911 OM 427.950 OM 427.951 OM 427.952</p>	<p>6 Cyl.</p>	<p>03-25105-10 447 010 07 20 </p> <p>03-25105-15 </p>	<p>08-23601-05 427 010 00 05 </p>	<p>15-28490-01 6x 442 011 00 59 +025 997 84 48 +025 997 85 48 (2x)</p> <p>15-76930-01 6x 025 997 84 48 (2x) +025 997 85 48 (2x)</p>	<p>61-25105-15 6x 422 016 04 20 144 Ø 1,25 mm</p> <p>61-25105-55 6x 422 016 04 20 144 Ø 1,25 mm MLS </p>	<p>14-32060-01 6x 422 990 02 01 (1x) +422 990 03 01 (3x) +422 990 04 01 (2x) </p>	<p>71-23906-20 6x 442 016 07 21 </p>	<p>70-23096-10 12x 422 053 01 96 </p>	<p>71-26069-20 6x 442 141 17 80 </p> <p>71-25749-00 6x 407 142 01 80 </p>	<p>71-23601-10 447 014 00 22 </p>	<p>81-23301-60 014 997 46 47 105x130 A FIL RD FPM </p> <p>81-23113-00 013 997 14 47 120x140 AB SL LD FPM </p>	

MERCEDES-BENZ

OM 441
OM 441 (RAM-Air)

OM 441.905
OM 441.906
OM 441.907
OM 441.908
OM 441.909
OM 441.910
OM 441.911
OM 441.912
OM 441.913
OM 441.914
OM 441.915
OM 441.916
OM 441.917
OM 441.918
OM 441.919
OM 441.920
OM 441.921
OM 441.922
OM 441.923
OM 441.924
OM 441.925
OM 441.926
OM 441.927
OM 441.932
OM 441.933

6 Cyl.

<p>01-25105-37</p>	<p>03-25105-08 444 010 01 20 +422 053 01 96 (2x)</p> <p>03-25105-11 444 010 01 20</p> <p>03-25105-12</p>	<p>08-23922-04 421 010 04 08</p>	<p>15-25799-02 </p> <p>423 010 48 33</p> <p>15-28490-01 </p> <p>442 011 00 59 +025 997 84 48 +025 997 85 48 (2x)</p> <p>15-76930-01 </p> <p>025 997 84 48 (2x) +025 997 85 48 (2x)</p>	<p>61-25105-15 6x 422 016 04 20 144 Ø 1,25 mm</p> <p>61-25105-55 6x 422 016 04 20 144 Ø 1,25 mm MLS</p>	<p>14-32060-01 6x 422 990 02 01 (1x) +422 990 03 01 (3x) +422 990 04 01 (2x)</p>	<p>71-23906-20 6x 442 016 07 21</p>	<p>70-23096-10 12x 422 053 01 96</p>	<p>71-26069-20 6x 442 141 17 80</p> <p>71-23079-00 6x 403 142 03 80</p>	<p>71-23922-10 441 014 00 22</p>	<p>81-23301-60 </p> <p>014 997 46 47 105x130 A FIL RD FPM</p> <p>81-23113-00 </p> <p>013 997 14 47 120x140 AB SL LD FPM</p>

MERCEDES-BENZ

OM 442
 OM 440.905
 OM 440.906
 OM 440.907
 OM 440.908
 OM 440.909
 OM 440.910
 OM 440.911
 OM 440.912
 OM 442.905
 OM 442.906
 OM 442.907
 OM 442.908
 OM 442.909
 OM 442.910
 OM 442.911
 OM 442.912
 OM 442.913
 OM 442.914
 OM 442.915
 OM 442.916
 OM 442.917
 OM 442.918
 OM 442.919
 OM 442.920
 OM 442.921
 OM 442.922
 OM 442.923
 OM 442.924
 OM 442.925
 OM 442.926
 OM 442.927
 OM 442.928
 OM 442.929
 OM 442.930
 OM 442.931
 OM 442.932
 OM 442.933
 OM 442.934
 OM 442.935
 OM 442.939

8 Cyl.

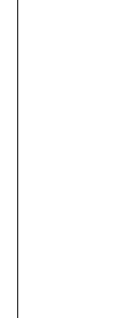
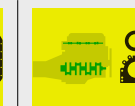
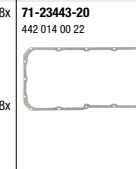
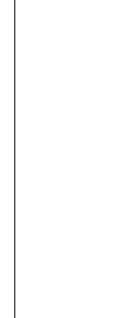
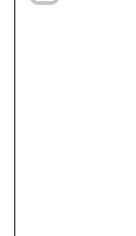
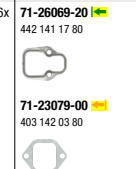
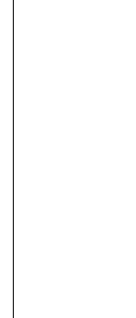
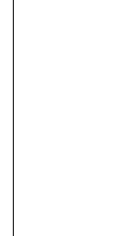
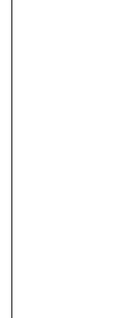
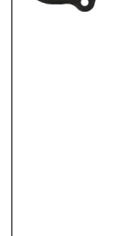
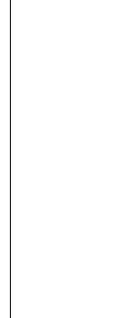
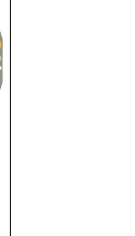
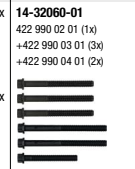
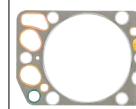
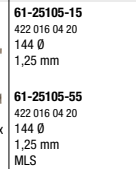
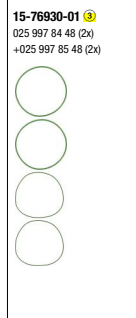
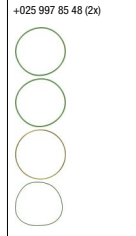
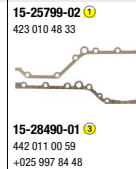
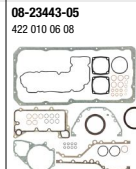
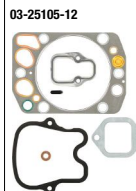
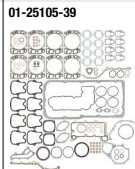

OM 443
 OM 443 A
 OM 443 LA
 OM 443.900
 OM 443.901
 OM 443.905
 OM 443.906
 OM 443.908
 OM 443.909
 OM 443.940
 OM 443.980

10 Cyl.

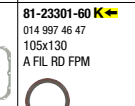
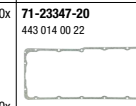
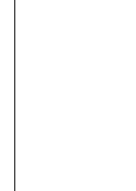
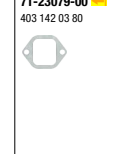
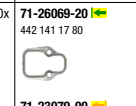
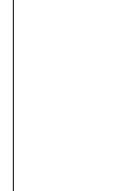
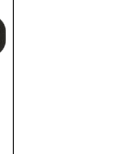
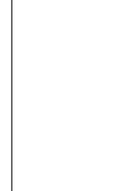
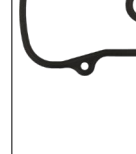
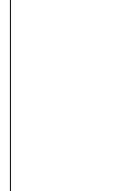
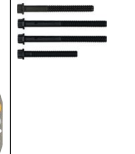
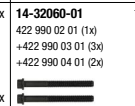
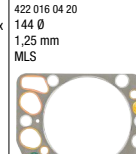
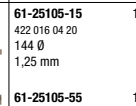
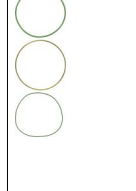
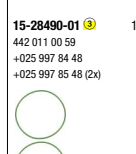
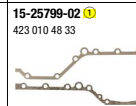
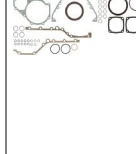
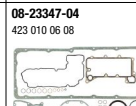
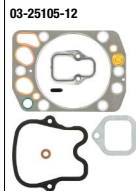

01-25105-39

03-25105-08

08-23443-05

15-25799-02

61-25105-15

14-32060-01

71-23906-20

70-23096-10

71-26069-20

71-23443-20

81-23301-60

444 010 01 20
 +422 053 01 96 (2x)

444 010 01 20
 +422 053 01 96 (2x)

422 010 06 08

423 010 48 33
 144 Ø
 1,25 mm

422 016 04 20
 144 Ø
 1,25 mm
 MLS

422 990 02 01 (1x)
 +422 990 03 01 (3x)
 +422 990 04 01 (2x)

442 016 07 21

422 053 01 96

442 141 17 80
 71-23079-00
 403 142 03 80

442 014 00 22

014 997 46 47
 105x130
 A FIL RD FPM
 81-23113-00
 013 997 14 47
 120x140
 AB SL LD FPM

03-25105-11

03-25105-12

08-23347-04

15-25799-02

61-25105-15

14-32060-01

71-23906-20

70-23096-10

71-26069-20

71-23347-20

81-23301-60

444 010 01 20

444 010 01 20

423 010 06 08

423 010 48 33
 144 Ø
 1,25 mm

422 016 04 20
 144 Ø
 1,25 mm
 MLS

422 990 02 01 (1x)
 +422 990 03 01 (3x)
 +422 990 04 01 (2x)

442 016 07 21

422 053 01 96

442 141 17 80
 71-23079-00
 403 142 03 80

443 014 00 22

014 997 46 47
 105x130
 A FIL RD FPM
 81-23113-00
 013 997 14 47
 120x140
 AB SL LD FPM

03-25105-11

03-25105-12

08-23347-04

15-25799-02

61-25105-15

14-32060-01

71-23906-20

70-23096-10

71-26069-20

71-23347-20

81-23301-60

444 010 01 20

444 010 01 20

423 010 06 08

423 010 48 33
 144 Ø
 1,25 mm

422 016 04 20
 144 Ø
 1,25 mm
 MLS

422 990 02 01 (1x)
 +422 990 03 01 (3x)
 +422 990 04 01 (2x)

442 016 07 21













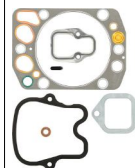
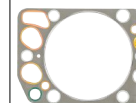
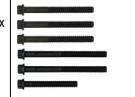
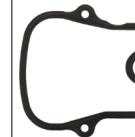





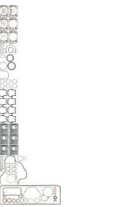

422 053 01 96

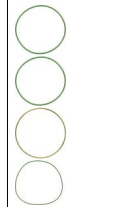
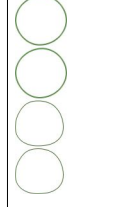
442 141 17 80
 71-23079-00
 403 142 03 80

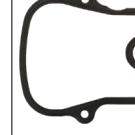















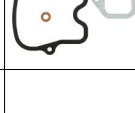































443 014 00 22

014 997 46 47
 105x130
 A FIL RD FPM
 81-23113-00
 013 997 14 47
 120x140
 AB SL LD FPM

MERCEDES-BENZ

<p>M 447 hLAG M 447 HLAG M 476</p>		<p>M 476.920 M 476.921 M 476.925 M 476.926 M 476.927 M 476.930 M 476.932 M 476.933 M 476.934 M 476.935 M 476.936 M 476.937</p>	<p>6 Cyl.</p>		<p>03-25105-11 444 010 01 20</p>  <p>6x</p> <p>03-25105-12 444 010 01 20</p>  <p>6x</p>	<p>61-25105-15 422 016 04 20 144 Ø 1,25 mm</p> <p>61-25105-55 422 016 04 20 144 Ø 1,25 mm MLS</p> 	<p>14-32060-01 422 990 02 01 (1x) +422 990 03 01 (3x) +422 990 04 01 (2x)</p> 	<p>71-23906-20 442 016 07 21</p> 	<p>70-23096-10 422 053 01 96</p> 	<p>71-26069-20 442 141 17 80</p>  <p>71-23079-00 403 142 03 80</p> 	<p>71-23601-10 447 014 00 22</p>  <p>81-23301-60 014 997 46 47 105x130 A FIL RD FPM</p>  <p>81-23113-00 013 997 14 47 120x140 AB SL LD FPM</p> 
<p>OM 447 OM 447 H OM 447 HA OM 447 HLAG OM 447 HO</p>	<p>01-25105-41</p> 	<p>OM 447.900 OM 447.902 OM 447.905 OM 447.906 OM 447.907 OM 447.908 OM 447.910 OM 447.911 OM 447.912 OM 447.913 OM 447.914 OM 447.915 OM 447.916 OM 447.950 OM 447.951 OM 447.952 OM 447.953 OM 447.954 OM 447.955 OM 447.956 OM 447.957 OM 447.958 OM 447.959 OM 447.968 OM 447.970 OM 447.971 OM 447.972 OM 447.973 OM 447.974 OM 447.975 OM 447.976 OM 447.977 OM 447.978 OM 447.979 OM 447.980 OM 447.981 OM 447.982 OM 447.983 OM 447.984 OM 447.985 OM 447.986 OM 447.987 OM 447.988 OM 447.990 OM 447.991 OM 447.992 OM 447.993 OM 447.994 OM 447.995 OM 447.996 OM 447.998 OM 447.999</p>	<p>6 Cyl.</p>	<p>03-25105-10 447 010 07 20</p>  <p>03-25105-15</p> 	<p>08-23601-05 427 010 00 05</p>  <p>15-28490-01 442 011 00 59 +025 997 84 48 +025 997 85 48 (2x)</p>  <p>15-76930-01 025 997 84 48 (2x) +025 997 85 48 (2x)</p> 	<p>61-25105-15 422 016 04 20 144 Ø 1,25 mm</p> <p>61-25105-55 422 016 04 20 144 Ø 1,25 mm MLS</p> 	<p>14-32060-01 422 990 02 01 (1x) +422 990 03 01 (3x) +422 990 04 01 (2x)</p> 	<p>71-23906-20 442 016 07 21</p> 	<p>70-23096-10 422 053 01 96</p> 	<p>71-26069-20 442 141 17 80</p>  <p>71-25749-00 407 142 01 80</p> 	<p>71-23601-10 447 014 00 22</p>  <p>81-23301-60 014 997 46 47 105x130 A FIL RD FPM</p>  <p>81-23113-00 013 997 14 47 120x140 AB SL LD FPM</p> 

MERCEDES-BENZ

<p>OM 447 A OM 447 LA</p> <p>OM 466.900 OM 476.916 OM 476.917 OM 476.950 OM 476.971 OM 476.972 OM 476.973 OM 476.977 OM 476.978 OM 476.979 OM 476.980 OM 476.981 OM 476.982 OM 476.983 OM 476.985 OM 476.988 OM 476.991 OM 476.992</p> <p>6 Cyl.</p>		 <p>03-25105-08 444 010 01 20 +422 053 01 96 (2x)</p>   <p>03-25105-11 444 010 01 20</p>   <p>03-25105-12</p>  		<p>15-28490-01  6x 442 011 00 59 +025 997 84 48 +025 997 85 48 (2x)</p>    	<p>61-25105-15 6x 422 016 04 20 144 Ø 1,25 mm</p> <p>61-25105-55 6x 422 016 04 20 144 Ø 1,25 mm MLS</p> 	<p>14-32060-01 6x 422 990 02 01 (1x) +422 990 03 01 (3x) +422 990 04 01 (2x)</p> 	<p>71-23906-20 6x 442 016 07 21</p> 	<p>70-23096-10 12x 422 053 01 96</p> 	<p>71-26069-20  6x 442 141 17 80</p>  <p>71-23079-00  6x 403 142 03 80</p> 	<p>71-23601-10 447 014 00 22</p> 	<p>81-23301-60   014 997 46 47 105x130 A FIL RD FPM</p>  <p>81-23113-00   013 997 14 47 120x140 AB SL LD FPM</p> 
<p>OM 447 HLA</p> <p>OM 447.947 OM 447.948 OM 447.949 OM 447.960</p> <p>6 Cyl.</p>		<p>08-23601-05 427 010 00 05</p> 	<p>15-28490-01  6x 442 011 00 59 +025 997 84 48 +025 997 85 48 (2x)</p>    	<p>61-25105-15 6x 422 016 04 20 144 Ø 1,25 mm</p> <p>61-25105-55 6x 422 016 04 20 144 Ø 1,25 mm MLS</p> 	<p>14-32060-01 6x 422 990 02 01 (1x) +422 990 03 01 (3x) +422 990 04 01 (2x)</p> 	<p>71-23906-20 6x 442 016 07 21</p> 	<p>70-23096-10 6x 422 053 01 96</p> 	<p>71-26069-20  6x 442 141 17 80</p> 	<p>71-23601-10 447 014 00 22</p> 	<p>81-23301-60   014 997 46 47 105x130 A FIL RD FPM</p>  <p>81-23113-00   013 997 14 47 120x140 AB SL LD FPM</p> 	

MERCEDES-BENZ

OM 449 A
OM 449 LA
OM 489

5 Cyl.

- OM 475.907
- OM 475.950
- OM 475.951
- OM 475.952
- OM 475.953
- OM 475.954
- OM 475.974
- OM 475.976
- OM 475.977
- OM 475.978
- OM 475.979
- OM 475.982
- OM 475.984
- OM 475.985
- OM 475.986
- OM 475.989
- OM 475.991
- OM 475.994
- OM 475.997
- OM 475.998
- OM 485.980
- OM 489.960
- OM 489.961

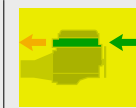

03-25105-08
444 010 01 20
+422 053 01 96 (2x)

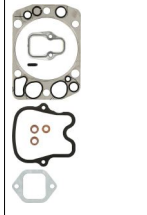

03-25105-11
444 010 01 20

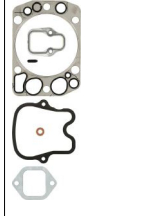

03-25105-12

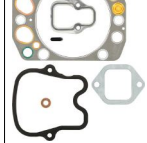

61-25105-15 5x
422 016 04 20
144 Ø
1,25 mm

61-25105-55 5x
422 016 04 20
144 Ø
1,25 mm
MLS

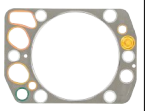

14-32060-01 5x
422 990 02 01 (1x)
+422 990 03 01 (3x)
+422 990 04 01 (2x)



71-23906-20 5x
442 016 07 21



70-23096-10 10x
422 053 01 96



71-26069-20 5x
442 141 17 80

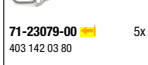

71-23079-00 5x
403 142 03 80



81-23301-60 K↔
014 997 46 47
105x130
A FIL RD FPM



81-23113-00 K↔
013 997 14 47
120x140
AB SL LD FPM



OM 457
OM 457 HLA

6 Cyl.

- OM 457.950
- OM 457.952
- OM 457.959
- OM 457.964
- OM 457.965
- OM 457.966
- OM 457.967
- OM 457.973
- OM 457.974

03-34285-06 6x
085588

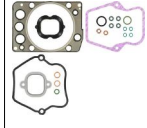

03-37770-04 6x
085589→

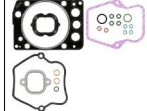

08-38384-01
457 010 16 05



61-34285-20 6x
460 016 05 20
143 Ø
1,25 mm
085588

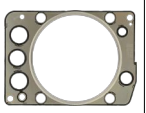

61-37770-00 6x
460 016 07 20
143 Ø
1,25 mm
085589→

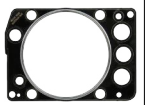

14-32069-01 6x
457 990 02 01 (4x)



71-34258-00 6x
457 016 00 21



71-34867-10 6x
457 016 02 21

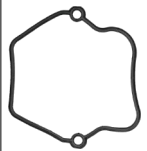

70-27214-00 24x
000 053 35 58



71-34432-00 6x
457 141 00 80

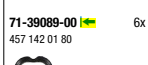

71-39089-00 6x
457 142 01 80



71-40966-00 2x
457 142 07 80



71-40967-00
457 140 00 80



71-40977-00
457 014 02 22



81-23301-60 K↔
014 997 46 47
105x130
A FIL RD FPM



81-23113-00 K↔
013 997 14 47
120x140
AB SL LD FPM



MERCEDES-BENZ

OM 457
OM 457 HLA
OM 457 LA
OM 460 LA

OM 457.917
OM 457.918
OM 457.927
OM 457.932
OM 457.937
OM 457.947
OM 457.948
OM 457.951
OM 457.953
OM 457.956
OM 457.957
OM 457.958
OM 457.960
OM 457.961
OM 457.962
OM 457.968
OM 457.969
OM 457.970
OM 457.975
OM 457.976
OM 457.977
OM 457.980
OM 457.981
OM 457.984
OM 458.970
OM 458.980
OM 458.990
OM 458.991
OM 458.992
OM 460.960
OM 460.961

6 Cyl.

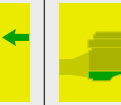
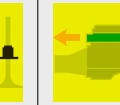

03-34285-05 6x
085588

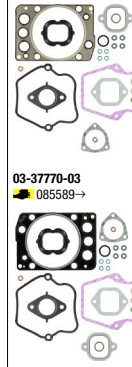

03-37770-03 6x
085589→

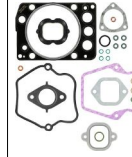

08-38384-01 457 010 16 05



61-34285-20 6x
460 016 05 20
143 Ø
1,25 mm
085588

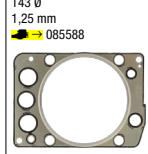

61-37770-00 6x
460 016 07 20
143 Ø
1,25 mm
085589→

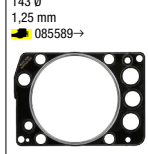

14-32069-01 6x
457 990 02 01 (4x)



71-34258-00 6x
457 016 00 21



71-34867-10 6x
457 016 02 21

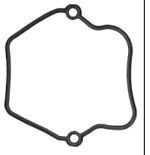

70-27214-00 24x
000 053 35 58



71-34432-00 6x
457 141 00 80



71-39089-00 6x
457 142 01 80



71-35327-00 6x
541 142 04 80



71-40977-00 457 014 02 22



81-23301-60 K 014 997 46 47
105x130
A FIL RD FPM



81-23113-00 K 013 997 14 47
120x140
AB SL LD FPM



OM 457 hLA

OM 457.933
OM 457.934
OM 457.935
OM 457.938
OM 457.941
OM 457.942

6 Cyl.



03-34285-06 6x
085588

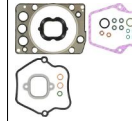

03-37770-04 6x
085589→

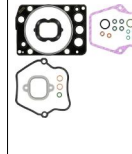

08-38384-01 457 010 16 05



61-34285-20 6x
460 016 05 20
143 Ø
1,25 mm
085588

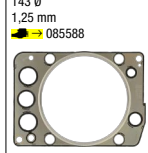

61-37770-00 6x
460 016 07 20
143 Ø
1,25 mm
085589→

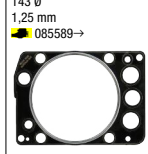

14-32069-01 6x
457 990 02 01 (4x)



71-34258-00 6x
457 016 00 21

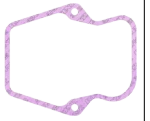

71-34867-10 6x
457 016 02 21

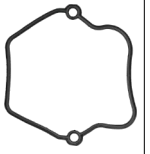

70-27214-00 24x
000 053 35 58



71-34432-00 6x
457 141 00 80



71-39089-00 6x
457 142 01 80



71-40966-00 2x
457 142 07 80



71-40967-00 2x
457 140 00 80



71-23601-20 447 014 03 22

























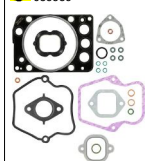
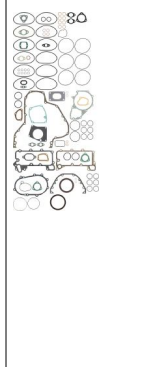
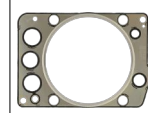

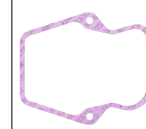
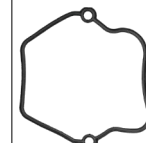









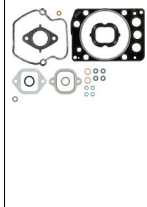
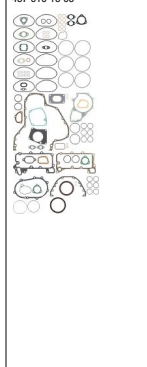
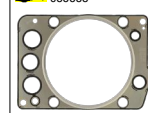

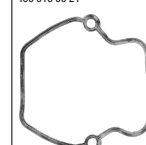

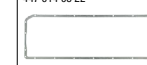

81-23301-60 K 014 997 46 47
105x130
A FIL RD FPM

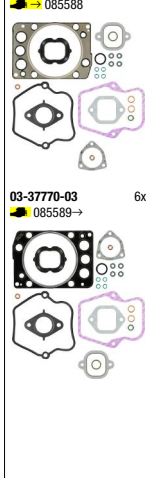
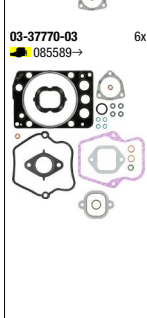
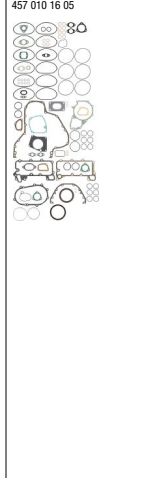
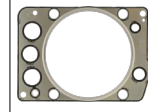

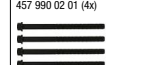
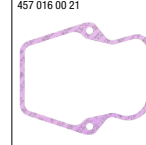
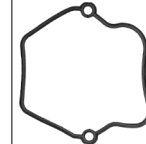
81-23113-00 K 013 997 14 47
120x140
AB SL LD FPM

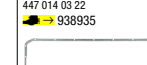
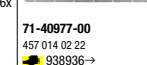

MERCEDES-BENZ

<p>OM 457 HLA</p> 											
<p>OM 457.954 6 Cyl.</p>	<p>03-34285-05 085588</p>  <p>03-3770-03 085589→</p> 	<p>08-38384-01 457 010 16 05</p> 		<p>61-34285-20 6x 460 016 05 20 143 Ø 1,25 mm 085588</p>  <p>61-3770-00 6x 460 016 07 20 143 Ø 1,25 mm 085589→</p> 	<p>14-32069-01 6x 457 990 02 01 (4x)</p> 	<p>71-34258-00 6x 457 016 00 21</p>  <p>71-34867-10 6x 457 016 02 21</p> 	<p>70-27214-00 24x 000 053 35 58</p> 	<p>71-34432-00 6x 457 141 00 80</p>  <p>71-39089-00 6x 457 142 01 80</p>  <p>71-40967-00 6x 457 140 00 80</p> 	<p>71-40977-00 457 014 02 22</p>  <p>71-41389-00 457 014 05 22</p> 	<p>81-23301-60 K 014 997 46 47 105x130 A FIL RD FPM</p>  <p>81-23113-00 K 013 997 14 47 120x140 AB SL LD FPM</p> 	
<p>OM 457 LA</p> <p>OM 457 LA OM 457.910 OM 457.922</p> <p>6 Cyl.</p>	<p>03-34285-03 6x 085588</p>  <p>03-3770-01 6x 085589→</p> 	<p>08-38384-01 457 010 16 05</p> 		<p>61-34285-20 6x 460 016 05 20 143 Ø 1,25 mm 085588</p>  <p>61-3770-00 6x 460 016 07 20 143 Ø 1,25 mm 085589→</p> 	<p>14-32069-01 6x 457 990 02 01 (4x)</p> 	<p>71-40956-00 6x 460 016 00 21</p> 	<p>70-27214-00 24x 000 053 35 58</p> 	<p>71-34432-00 6x 457 141 00 80</p>  <p>71-39089-00 6x 457 142 01 80</p>  <p>71-23079-00 6x 403 142 03 80</p> 	<p>71-23601-20 447 014 03 22</p> 	<p>81-23301-60 K 014 997 46 47 105x130 A FIL RD FPM</p>  <p>81-23113-00 K 013 997 14 47 120x140 AB SL LD FPM</p> 	
<p>OM 457 LA</p> <p>OM 457.914 OM 457.915 OM 457.916</p> <p>6 Cyl.</p>	<p>03-34285-05 6x 085588</p>  <p>03-3770-03 6x 085589→</p> 	<p>08-38384-01 457 010 16 05</p> 		<p>61-34285-20 6x 460 016 05 20 143 Ø 1,25 mm 085588</p>  <p>61-3770-00 6x 460 016 07 20 143 Ø 1,25 mm 085589→</p> 	<p>14-32069-01 6x 457 990 02 01 (4x)</p> 	<p>71-34258-00 6x 457 016 00 21</p>  <p>71-34867-10 6x 457 016 02 21</p> 	<p>70-27214-00 24x 000 053 35 58</p> 	<p>71-34432-00 6x 457 141 00 80</p>  <p>71-39089-00 6x 457 142 01 80</p>  <p>71-35327-00 6x 541 142 04 80</p> 	<p>71-23601-20 447 014 03 22 938935</p>  <p>71-40977-00 457 014 02 22 938936→</p> 	<p>81-23301-60 K 014 997 46 47 105x130 A FIL RD FPM</p>  <p>81-23113-00 K 013 997 14 47 120x140 AB SL LD FPM</p> 	

MERCEDES-BENZ

OM 457 LA OM 457.919 6 Cyl.

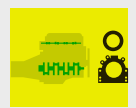
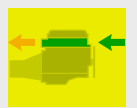

03-34285-03 6x
085588

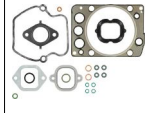

03-37770-01 6x
085589



08-38384-01 457 010 16 05



61-34285-20 6x
460 016 05 20
143 Ø
1,25 mm
085588

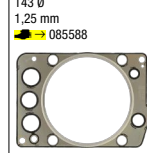

61-37770-00 6x
460 016 07 20
143 Ø
1,25 mm
085589

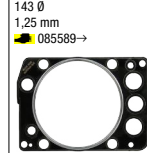

14-32069-01 6x
457 990 02 01 (4x)



71-40956-00 6x
460 016 00 21



70-27214-00 24x
000 053 35 58



71-34432-00 6x
457 141 00 80



71-39089-00 6x
457 142 01 80



71-35327-00 6x
541 142 04 80



71-23601-20 447 014 03 22



81-23301-60 K 014 997 46 47
105x130
A FIL RD FPM



81-23113-00 K 013 997 14 47
120x140
AB SL LD FPM



OM 457 LA OM 457.920 OM 457.923 OM 457.936 OM 457.939 OM 457.940 OM 457.943 OM 457.944 OM 457.945 OM 457.946 OM 457.949 OM 457.955 OM 458.960 6 Cyl.

03-34285-05 6x
085588

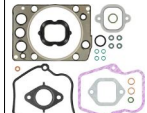

03-37770-03 6x
085589

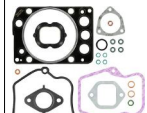

08-38384-01 457 010 16 05



61-34285-20 6x
460 016 05 20
143 Ø
1,25 mm
085588

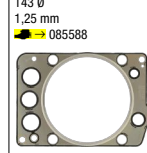

61-37770-00 6x
460 016 07 20
143 Ø
1,25 mm
085589

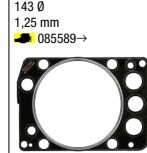

14-32069-01 6x
457 990 02 01 (4x)



71-34258-00 6x
457 016 00 21

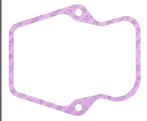

71-34867-10 6x
457 016 02 21

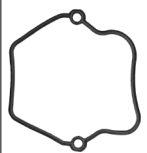

70-27214-00 24x
000 053 35 58



71-34432-00 6x
457 141 00 80



71-39089-00 6x
457 142 01 80



71-35327-00 6x
541 142 04 80



71-23601-20 447 014 03 22



81-23301-60 K 014 997 46 47
105x130
A FIL RD FPM



81-23113-00 K 013 997 14 47
120x140
AB SL LD FPM



OM 457 LA OM 457.924 OM 457.925 OM 457.926 OM 457.928 OM 457.929 OM 457.931 6 Cyl.

03-34285-05 6x
085588

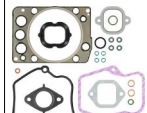

03-37770-03 6x
085589

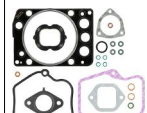

08-38384-01 457 010 16 05



61-34285-20 6x
460 016 05 20
143 Ø
1,25 mm
085588

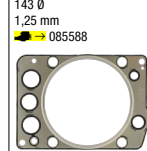

61-37770-00 6x
460 016 07 20
143 Ø
1,25 mm
085589

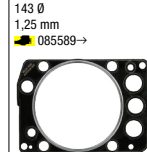

14-32069-01 6x
457 990 02 01 (4x)



71-34258-00 6x
457 016 00 21



71-34867-10 6x
457 016 02 21

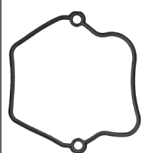

70-27214-00 24x
000 053 35 58



71-34432-00 6x
457 141 00 80



71-39089-00 6x
457 142 01 80



71-23079-00 6x
403 142 03 80

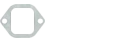

71-23601-20 447 014 03 22















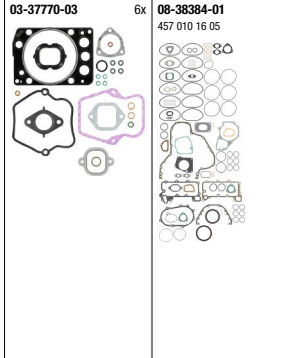







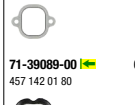
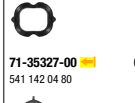







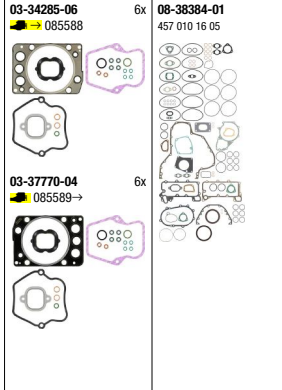
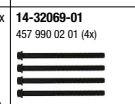
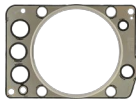



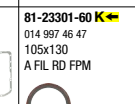
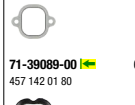





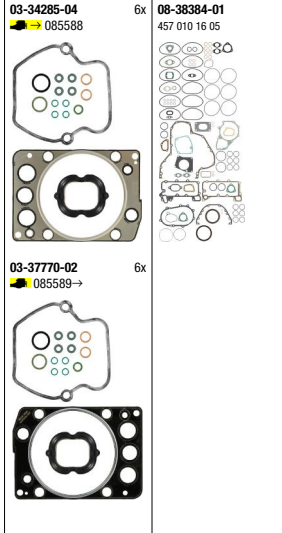
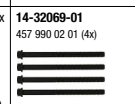
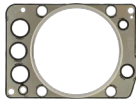

81-23301-60 K 014 997 46 47
105x130
A FIL RD FPM

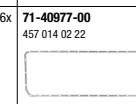

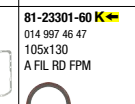
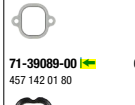
81-23113-00 K 013 997 14 47
120x140
AB SL LD FPM



MERCEDES-BENZ

<p>OM 457 LA OM 457 LA ES OM 460 LA</p>		<p>OM 457.907 OM 457.911 OM 457.982 OM 457.983 OM 457.985 OM 460.989</p>	<p>6 Cyl.</p>		<p>03-3770-03 6x 08-38384-01 457 010 16 05</p> 		<p>61-37770-00 6x 460 016 07 20 143 Ø 1,25 mm</p> 	<p>14-32069-01 6x 457 990 02 01 (4x)</p> 	<p>71-34258-00 6x 457 016 00 21</p> <p>71-34867-10 6x 457 016 02 21</p>  	<p>12-27214-05 457 016 00 21</p> <p>70-27214-00 24x 000 053 35 58</p>  	<p>71-34432-00 6x 457 141 00 80</p> <p>71-39089-00 6x 457 142 01 80</p> <p>71-35327-00 6x 541 142 04 80</p>    	<p>71-40977-00 457 014 02 22 938935</p> <p>71-41389-00 457 014 05 22 938936→</p>   	<p>81-10398-00 K↔ 014 997 98 46 100x130 A SL RD FPM</p> <p>81-36197-00 K↔ 021 997 53 47 115x140 AB SL LD PTFE</p>  
<p>OM 460 HLA</p>		<p>OM 460.950 OM 460.951 OM 460.953</p>	<p>6 Cyl.</p>		<p>03-34285-06 6x 085588</p> <p>03-3770-04 6x 085589→</p> <p>08-38384-01 457 010 16 05</p> 		<p>61-34285-20 6x 460 016 05 20 143 Ø 1,25 mm 085588</p> 	<p>14-32069-01 6x 457 990 02 01 (4x)</p> 	<p>71-34867-10 6x 457 016 02 21</p> 	<p>70-27214-00 24x 000 053 35 58</p>  	<p>71-34432-00 6x 457 141 00 80</p> <p>71-39089-00 6x 457 142 01 80</p> <p>71-40968-00 3x 460 142 23 80</p>    	<p>71-40977-00 457 014 02 22</p>  	<p>81-23301-60 K↔ 014 997 46 47 105x130 A FIL RD FPM</p> <p>81-23113-00 K↔ 013 997 14 47 120x140 AB SL LD FPM</p>  
<p>OM 460 LA</p>		<p>OM 460.926 OM 460.927 OM 460.932 OM 460.933 OM 460.934 OM 460.935 OM 460.936 OM 460.937 OM 460.938 OM 460.939 OM 460.940 OM 460.941 OM 460.942 OM 460.943 OM 460.944 OM 460.945 OM 460.946 OM 460.947 OM 460.948 OM 460.949</p>	<p>6 Cyl.</p>		<p>03-34285-04 6x 085588</p> <p>03-3770-02 6x 085589→</p> <p>08-38384-01 457 010 16 05</p> 		<p>61-34285-20 6x 460 016 05 20 143 Ø 1,25 mm 085588</p> 	<p>14-32069-01 6x 457 990 02 01 (4x)</p> 	<p>71-40956-00 6x 460 016 00 21</p> 	<p>70-27214-00 24x 000 053 35 58</p>  	<p>71-34432-00 6x 457 141 00 80</p> <p>71-39089-00 6x 457 142 01 80</p> <p>71-36743-00 3x 460 142 21 80</p>   	<p>71-40977-00 457 014 02 22</p>  	<p>81-23301-60 K↔ 014 997 46 47 105x130 A FIL RD FPM</p> <p>81-23113-00 K↔ 013 997 14 47 120x140 AB SL LD FPM</p>  

MERCEDES-BENZ

OM 460 LA
 OM 460.974
 OM 460.975
 OM 460.976
 OM 460.977
 OM 460.978
 OM 460.979
 OM 460.980
 OM 460.981

6 Cyl.

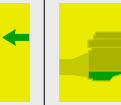
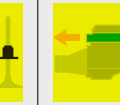
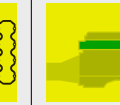

OM 460 LA
 OM 460.982
 OM 460.983

6 Cyl.

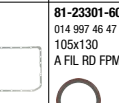
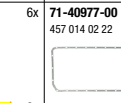
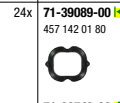
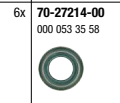
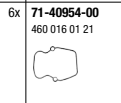
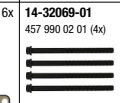

03-34285-07
 085588

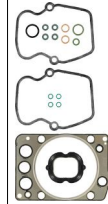

03-37770-05
 085589→

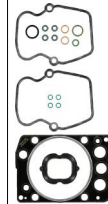

08-38384-01
 457 010 16 05

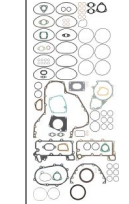

61-34285-20
 460 016 05 20
 143 Ø
 1,25 mm
 085588

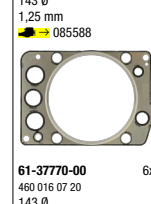

61-37770-00
 460 016 07 20
 143 Ø
 1,25 mm
 085589→

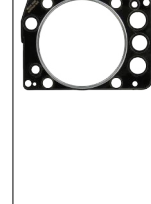

14-32069-01
 457 990 02 01 (4x)



71-40954-00
 460 016 01 21

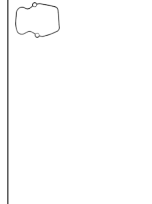

70-27214-00
 000 053 35 58

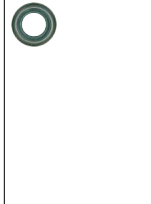

71-39089-00
 457 142 01 80

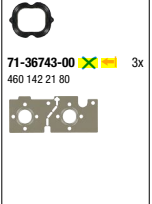

71-36743-00
 460 142 21 80



71-40977-00
 457 014 02 22



81-23301-60
 014 997 46 47
 105x130
 A FIL RD FPM



81-23113-00
 013 997 14 47
 120x140
 AB SL LD FPM



03-34285-07
 085588

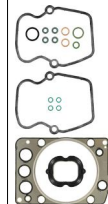

03-37770-05
 085589→

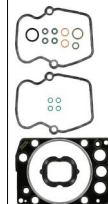

08-38384-01
 457 010 16 05



61-34285-20
 460 016 05 20
 143 Ø
 1,25 mm
 085588

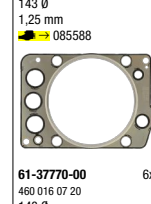

61-37770-00
 460 016 07 20
 143 Ø
 1,25 mm
 085589→

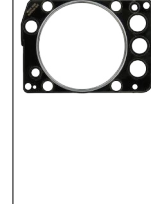

14-32069-01
 457 990 02 01 (4x)

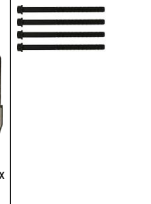

71-40954-00
 460 016 01 21

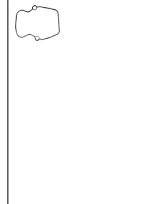

70-27214-00
 000 053 35 58

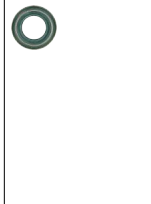

71-39089-00
 457 142 01 80

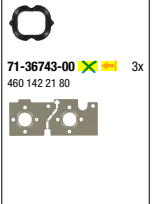

71-36743-00
 460 142 21 80



71-40977-00
 457 014 02 22























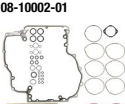

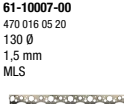
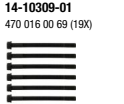
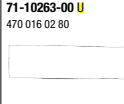
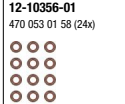
81-23301-60
 014 997 46 47
 105x130
 A FIL RD FPM



81-23113-00
 013 997 14 47
 120x140
 AB SL LD FPM

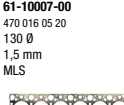
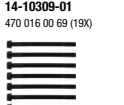

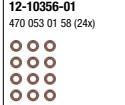
MERCEDES-BENZ

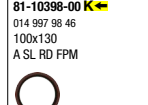
<p>OM 460 LA</p> <p>OM 460.900 OM 460.901 OM 460.902 OM 460.903 OM 460.904 OM 460.905 OM 460.906 OM 460.907 OM 460.908 OM 460.909 OM 460.910 OM 460.911 OM 460.912 OM 460.913 OM 460.914 OM 460.915 OM 460.916 OM 460.917 OM 460.918 OM 460.919 OM 460.920 OM 460.921 OM 460.922 OM 460.923 OM 460.925 OM 460.929 OM 460.931 OM 460.970 OM 460.971 OM 460.972 OM 460.984</p>		<p>6 Cyl.</p>									
<p>OM 470 LA</p> <p>OM 470.903 OM 470.906 OM 470.907 OM 470.917</p>		<p>6 Cyl.</p>									
<p>OM 470 LA</p> <p>OM 470.904 OM 470.908 OM 470.910 OM 470.913 OM 470.914 OM 470.915 OM 470.921 OM 470.922 OM 470.923</p>		<p>6 Cyl.</p>									

MERCEDES-BENZ

OM 471 LA OM 471.900 OM 471.909 6 Cyl.

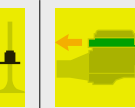
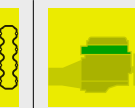
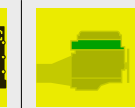

02-10173-01



02-37330-01

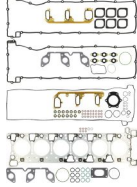

08-10002-01

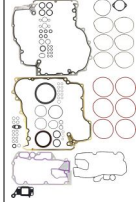

61-10173-00
471 016 07 20
133 Ø
1,2 mm
MLS



61-37330-00
471 016 12 20
137,4 Ø
1,3 mm



14-10581-01
471 016 00 69 (19X)

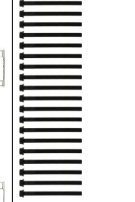

71-10353-00 U
471 016 04 80



71-10354-00 O 2x
471 016 01 21



12-10356-01
470 053 01 58 (24x)

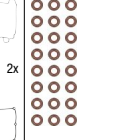

70-10356-00 24x
470 053 01 58



71-10275-00 I 6x
472 098 00 80



71-10268-00
471 142 01 80
Cyl. 1-3



71-10269-00
471 142 02 80
Cyl. 4-6



71-10272-00
471 203 06 80
Cyl. 1-3



71-10273-00
471 203 07 80
Cyl. 4-6



71-10274-00 16
471 096 03 80



70-31414-10
471 014 07 22



71-10294-00
471 014 07 22



81-10398-00 K
014 997 98 46
100x130
A SL RD FPM



81-10400-00 K
015 997 49 46
138x163
A SL LD FPM

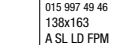

OM 471 LA OM 471.901 OM 471.905 6 Cyl.

02-10173-01



08-10002-01

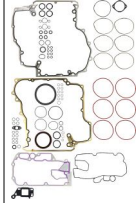

61-10173-00
471 016 07 20
133 Ø
1,2 mm
MLS



14-10581-01
471 016 00 69 (19X)

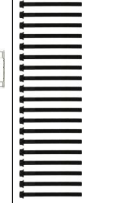

71-10353-00 U
471 016 04 80



71-10354-00 O 2x
471 016 01 21



12-10356-01
470 053 01 58 (24x)

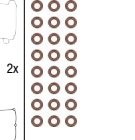

70-10356-00 24x
470 053 01 58



71-10275-00 I 6x
472 098 00 80



71-10268-00
471 142 01 80
Cyl. 1-3



71-10269-00
471 142 02 80
Cyl. 4-6



71-10272-00
471 203 06 80
Cyl. 1-3



71-10273-00
471 203 07 80
Cyl. 4-6



71-10274-00 16
471 096 03 80



70-31414-10
471 014 04 22



81-10399-00 K
016 997 06 46
100x130
A SL FIL RD PTFE



81-10400-00 K
015 997 49 46
138x163
A SL LD FPM

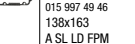

MERCEDES-BENZ

OM 471 LA
OM 471.902
OM 471.906
6 Cyl.

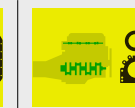
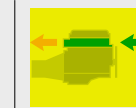

02-10173-01

08-10002-01

02-37330-01

61-10173-00
471 016 07 20
133 Ø
1,2 mm
MLS

61-37330-00
471 016 12 20
137,4 Ø
1,3 mm

14-10581-01
471 016 00 69 (19X)

71-10353-00 U
471 016 04 80

71-10354-00 U 2x
471 016 01 21

12-10356-01
470 053 01 58 (24x)

70-10356-00 24x
470 053 01 58

71-10275-00 6x
472 098 00 80

71-10268-00
471 142 01 80
Cyl. 1-3

71-10269-00
471 142 02 80
Cyl. 4-6

71-10272-00
471 203 06 80
Cyl. 1-3

71-10273-00
471 203 07 80
Cyl. 4-6

71-10274-00 16
471 096 03 80

70-31414-10

71-10323-00
471 014 04 22

81-10398-00 K
014 997 98 46
100x130
A SL RD FPM

81-10400-00 K
015 997 49 46
138x163
A SL LD FPM

OM 471 LA
OM 471.903
6 Cyl.

02-10173-01

08-10002-01

61-10173-00
471 016 07 20
133 Ø
1,2 mm
MLS

14-10581-01
471 016 00 69 (19X)

71-10354-00 U
471 016 01 21

71-12388-00 U
471 016 02 21

12-10356-01
470 053 01 58 (24x)

70-10356-00 24x
470 053 01 58

71-10275-00 6x
472 098 00 80

71-10268-00
471 142 01 80
Cyl. 1-3

71-10269-00
471 142 02 80
Cyl. 4-6

71-10272-00
471 203 06 80
Cyl. 1-3

71-10273-00
471 203 07 80
Cyl. 4-6

71-10274-00 16
471 096 03 80

70-31414-10













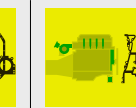

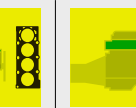

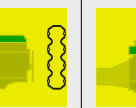
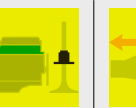
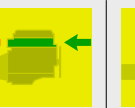

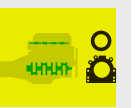
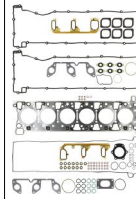
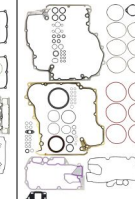

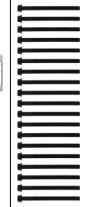

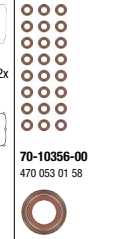

71-10323-00
471 014 04 22

81-10399-00 K
016 997 06 46
100x130
A SL FIL RD PTFE

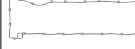









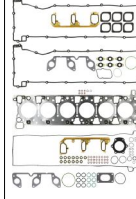

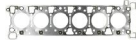
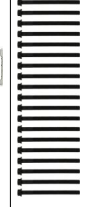
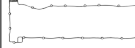
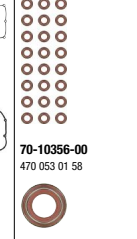

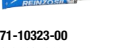
81-10400-00 K
015 997 49 46
138x163
A SL LD FPM

MERCEDES-BENZ

OM 471 LA OM 471.910 6 Cyl.

											
		<p>02-10173-01</p> 	<p>08-10002-01</p> 		<p>61-10173-00 471 016 07 20 133 Ø 1,2 mm MLS</p> 	<p>14-10581-01 471 016 00 69 (19X)</p> 	<p>71-10353-00 U 471 016 04 80</p> 	<p>12-10356-01 470 053 01 58 (24x)</p> 	<p>71-10275-00  6x 472 098 00 80</p> 	<p>70-31414-10</p> 	<p>81-10399-00 K  016 997 06 46 100x130 A SL FIL RD PTFE</p> 
						<p>71-10354-00 O 2x 471 016 01 21</p> 	<p>71-10356-00 24x 470 053 01 58</p> 	<p>71-10268-00  471 142 01 80 Cyl. 1-3</p> 	<p>71-10323-00 471 014 04 22</p> 	<p>81-10400-00 K  015 997 49 46 138x163 A SL LD FPM</p> 	

OM 471 LA OM 471.911 6 Cyl.

		<p>02-10173-01</p> 	<p>08-10002-01</p> 		<p>61-10173-00 471 016 07 20 133 Ø 1,2 mm MLS</p> 	<p>14-10581-01 471 016 00 69 (19X)</p> 	<p>71-10354-00 O 471 016 01 21</p> 	<p>12-10356-01 470 053 01 58 (24x)</p> 	<p>71-10275-00  6x 472 098 00 80</p> 	<p>70-31414-10</p> 	<p>81-10399-00 K  016 997 06 46 100x130 A SL FIL RD PTFE</p> 
							<p>71-12388-00 U 471 016 02 21</p> 	<p>71-10356-00 24x 470 053 01 58</p> 	<p>71-10268-00  471 142 01 80 Cyl. 1-3</p> 	<p>71-10323-00 471 014 04 22</p> 	<p>81-10400-00 K  015 997 49 46 138x163 A SL LD FPM</p> 

MERCEDES-BENZ

OM 471 LA OM 471.913 6 Cyl.

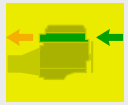

02-10173-01

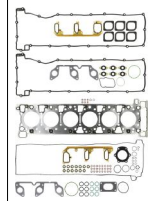

08-10002-01

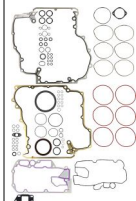

61-10173-00
471 016 07 20
133 Ø
1,2 mm
MLS



14-10581-01
471 016 00 69 (19X)



71-10353-00 U
471 016 04 80



71-10354-00 O
471 016 01 21

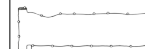

12-10356-01
470 053 01 58 (24x)

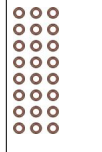

70-10356-00
470 053 01 58



71-10275-00 I 6x
472 098 00 80



71-10268-00 O
471 142 01 80
Cyl. 1-3

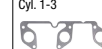

71-10269-00 O
471 142 02 80
Cyl. 4-6



71-10272-00 O
471 203 06 80
Cyl. 1-3



71-10273-00 O
471 203 07 80
Cyl. 4-6



70-31414-10
471 014 04 22



81-10399-00 K
016 997 06 46
100x130
A SL FIL RD PTFE



81-10400-00 K
015 997 49 46
138x163
A SL LD FPM



OM 471 LA OM 471.914 6 Cyl.

02-10173-01

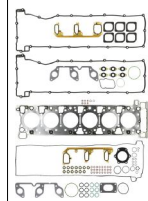

08-10002-01

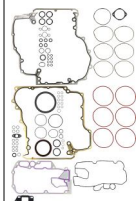

61-10173-00
471 016 07 20
133 Ø
1,2 mm
MLS



14-10581-01
471 016 00 69 (19X)



71-10353-00 U
471 016 04 80



71-12388-00 O 2x
471 016 02 21



12-10356-01
470 053 01 58 (24x)

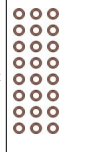

70-10356-00
470 053 01 58



71-10275-00 I 6x
472 098 00 80



71-10268-00 O
471 142 01 80
Cyl. 1-3

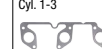

71-10269-00 O
471 142 02 80
Cyl. 4-6



71-10272-00 O
471 203 06 80
Cyl. 1-3



71-10273-00 O
471 203 07 80
Cyl. 4-6



70-31414-10
471 014 04 22



81-10399-00 K
016 997 06 46
100x130
A SL FIL RD PTFE



81-10400-00 K
015 997 49 46
138x163
A SL LD FPM



MERCEDES-BENZ

OM 471 LA OM 471.915 6 Cyl.

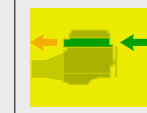

02-10173-01

02-37330-01

08-10002-01

61-10173-00
471 016 07 20
133 Ø
1,2 mm
MLS

61-37330-00
471 016 12 20
137,4 Ø
1,3 mm

14-10581-01
471 016 00 69 (19X)

71-10353-00 U
471 016 04 80

71-12388-00 O
471 016 02 21

12-10356-01
470 053 01 58 (24x)

70-10356-00
470 053 01 58

71-10275-00 I 6x
472 098 00 80

71-10268-00
471 142 01 80
Cyl. 1-3

71-10269-00
471 142 02 80
Cyl. 4-6

71-10272-00
471 203 06 80
Cyl. 1-3

71-10273-00
471 203 07 80
Cyl. 4-6

70-31414-10

71-10294-00
471 014 07 22

71-10323-00
471 014 04 22

81-10399-00 K →
016 997 06 46
100x130
A SL FIL RD PTFE

81-10400-00 K →
015 997 49 46
138x163
A SL LD FPM

OM 471 LA OM 471.917
OM 471.920 6 Cyl.

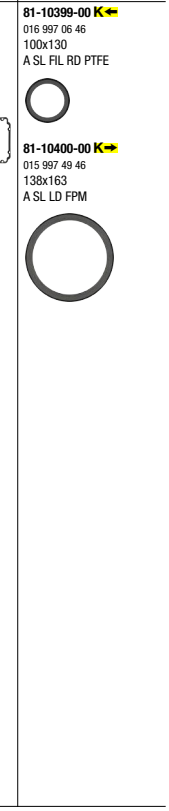
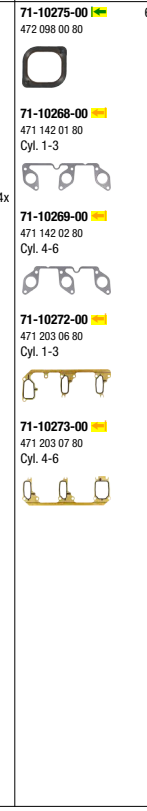
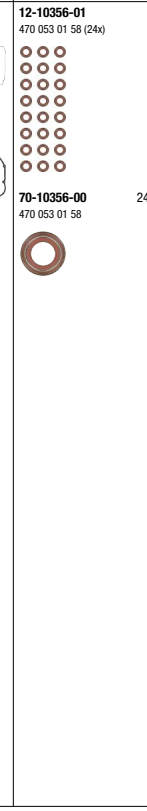
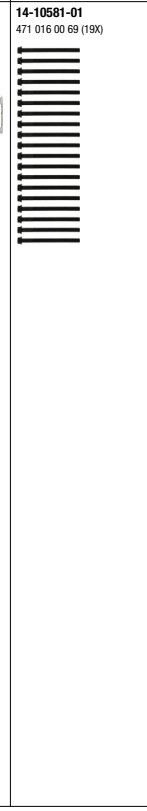
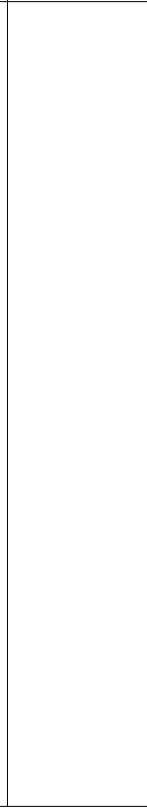

02-10173-01

08-10002-01

61-10173-00
471 016 07 20
133 Ø
1,2 mm
MLS

14-10581-01
471 016 00 69 (19X)

71-10353-00 U
471 016 04 80

71-12388-00 O
471 016 02 21

12-10356-01
470 053 01 58 (24x)

70-10356-00
470 053 01 58

71-10275-00 I 6x
472 098 00 80

71-10268-00
471 142 01 80
Cyl. 1-3

71-10269-00
471 142 02 80
Cyl. 4-6

71-10272-00
471 203 06 80
Cyl. 1-3

71-10273-00
471 203 07 80
Cyl. 4-6

70-31414-10

71-10323-00
471 014 04 22

81-10399-00 K →
016 997 06 46
100x130
A SL FIL RD PTFE

81-10400-00 K →
015 997 49 46
138x163
A SL LD FPM

MERCEDES-BENZ

OM 471 LA OM 471.919 6 Cyl.

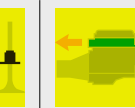
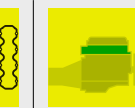
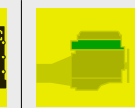

02-10173-01



02-37330-01

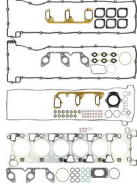

08-10002-01

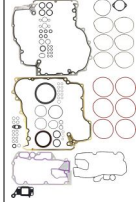

61-10173-00

471 016 07 20
133 Ø
1,2 mm
MLS



61-37330-00

471 016 12 20
137,4 Ø
1,3 mm



14-10581-01

471 016 00 69 (19X)

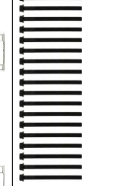

71-10353-00 U

471 016 04 80



71-10354-00 O 2x

471 016 01 21



12-10356-01

470 053 01 58 (24x)

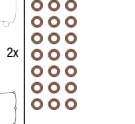

70-10356-00 24x



71-10275-00 I 6x

472 098 00 80



71-10268-00 O

471 142 01 80

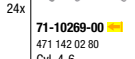

Cyl. 1-3



471 142 02 80



Cyl. 4-6



471 203 06 80



Cyl. 1-3



471 203 07 80



Cyl. 4-6



471 096 03 80



70-31414-10



71-10294-00

471 014 07 22

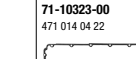

71-10323-00

471 014 04 22

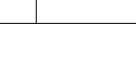
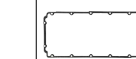
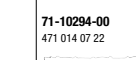

81-10398-00 K 014 997 98 46

100x130



A SL RD FPM

81-10400-00 K 015 997 49 46

138x163



A SL LD FPM

OM 471 LA OM 471.922 OM 471.926 OM 471.927 OM 471.928 OM 471.935 OM 471.951 6 Cyl.



02-37330-01

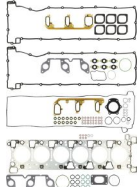

08-10002-01

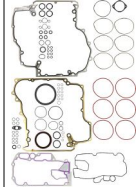

61-37330-00

471 016 12 20
137,4 Ø
1,3 mm



14-10581-01

471 016 00 69 (19X)

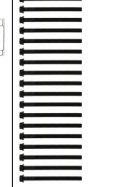

71-10354-00 O

471 016 01 21

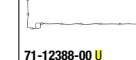

71-12388-00 U

471 016 02 21



12-10356-01

470 053 01 58 (24x)

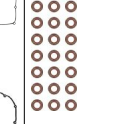

70-10356-00 24x



71-10275-00 I 6x

472 098 00 80



71-10268-00 O

471 142 01 80

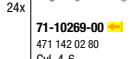

Cyl. 1-3



471 142 02 80



Cyl. 4-6



471 203 06 80



Cyl. 1-3



471 203 07 80



70-31414-10



71-10294-00

471 014 07 22

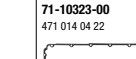

71-10323-00

471 014 04 22



81-10399-00 K 016 997 06 46

100x130



A SL FIL RD PTFE

81-10400-00 K 015 997 49 46

138x163



A SL LD FPM

MERCEDES-BENZ

OM 471 LA
 OM 471.932
 OM 471.933
 OM 471.934
 OM 471.937
 OM 471.938
 OM 471.940
 OM 471.941
 OM 471.942
 OM 471.946

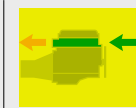

6 Cyl.

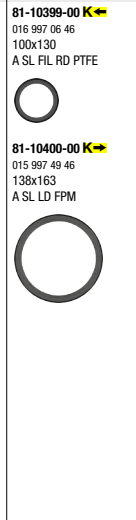
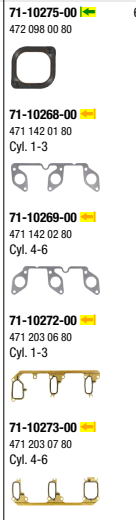
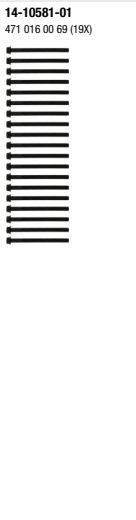
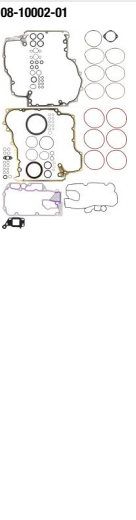
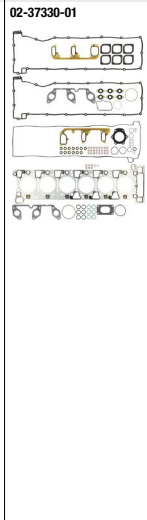

OM 471 LA OM 471.944 6 Cyl.

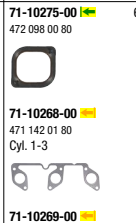
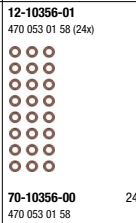
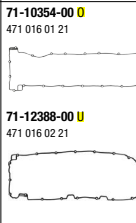
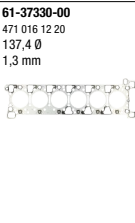
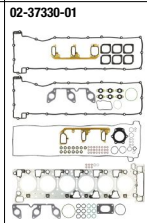

MERCEDES-BENZ

OM 501 LA
 OM 501 LA, III
 OM 501 LA,III
 OM 501 LA,III/1
 OM 501 LA,III/9
 OM 502 LA,III

 OM 521.940
 OM 521.950
 OM 521.951
 OM 541.920
 OM 541.921
 OM 541.922
 OM 541.923
 OM 541.924
 OM 541.925
 OM 541.926
 OM 541.927
 OM 541.928
 OM 541.940
 OM 541.941
 OM 541.942
 OM 541.943
 OM 541.944
 OM 541.945
 OM 541.946
 OM 541.947
 OM 541.949
 OM 541.950
 OM 541.951
 OM 541.952
 OM 541.953
 OM 541.959
 OM 541.960
 OM 541.970
 OM 541.971
 OM 541.972
 OM 541.973
 OM 541.974
 OM 541.975
 OM 541.976
 OM 541.977
 OM 541.978
 OM 541.979
 OM 541.980
 OM 541.981
 OM 541.990
 OM 541.991
 OM 541.992
 OM 541.993
 OM 541.994
 OM 541.995
 OM 541.996
 OM 541.997
 OM 541.998
 OM 541.999
 OM 941.910
 OM 941.920
 OM 941.921
 OM 941.929
 OM 941.930
 OM 941.940
 OM 941.960
 OM 941.970
 OM 941.980
 OM 941.981
 OM 941.990
 OM 941.991
 OM 941.992

6 Cyl.

<p>01-34190-01 541 010 13 05 +541 010 11 20(6x) +541 014 03 22 +000 053 35 58(24x) → 012090</p> <p>01-34190-02 541 010 13 05 +541 010 11 20 (6x) +541 014 07 22 +000 053 35 58 (24x) → 012091 → → 084423</p> <p>01-34190-05 541 010 13 05 +541 010 25 20 (6x) +541 014 07 22 +000 053 35 58 (24x) → 084424 → → 155295</p> <p>01-34190-06 541 010 13 05 +457 010 42 20 (6x) +541 014 07 22 +000 053 35 58 (24x) → 155296 → → 357748</p>	<p>03-34190-01 541 010 11 20 → 084423</p> <p>03-34190-02 541 010 25 20 → 084424 → → 155295</p> <p>03-34190-03 457 010 42 20 → 155296 → → 357748</p> <p>03-34195-01 → 357748</p> <p>03-37190-01 541 010 09 21 +541 016 13 20 → 357749 →</p> <p>03-37195-01 → 357749 →</p>	<p>08-33142-01 541 010 13 05</p>	<p>15-31313-01 541 010 21 33</p> <p>15-76031-01 541 011 00 59 +022 997 49 48 (2x) → 084654</p> <p>15-35170-01 541 011 00 59 +541 997 09 45 (2x) → 084655 →</p>	<p>61-34190-10 6x 541 016 16 20 150,5 Ø → 357748</p> <p>61-37190-10 6x 541 016 17 20 150,5 Ø → 357749 →</p>	<p>14-32068-01 6x 541 990 05 01 (4x)</p>	<p>71-33799-00 6x 541 016 03 21 → 084423</p> <p>71-35001-00 6x 541 016 04 21 → 084424 → → 155295</p> <p>71-34867-10 6x 457 016 02 21 → 155296 →</p>	<p>70-27214-00 24x 000 053 35 58</p>	<p>71-34033-00 541 098 04 80</p> <p>71-35327-00 541 142 04 80</p>	<p>71-34892-00 541 014 03 22 → 012090</p> <p>71-34904-00 541 014 07 22 → 012091 →</p> <p>71-42464-00 541 014 08 22</p>	<p>81-23301-60 014 997 46 47 105x130 A FIL RD FPM</p> <p>81-23113-00 013 997 14 47 120x140 AB SL LD FPM</p>		

MERCEDES-BENZ

OM 501 LA.III/9 OM 541.948 6 Cyl.

<p>01-34190-01 541 010 13 05 +541 010 11 20(6x) +541 014 03 22 +000 053 35 58(24x) → 012090</p>	<p>03-34190-01 541 010 11 20 → 084423</p> <p>03-34190-02 541 010 25 20 → 084424→ → 155295</p>	<p>08-33142-01 541 010 13 05</p>	<p>04-10054-01 (1) </p> <p>15-31313-01 (1) 541 010 21 33</p>	<p>61-34190-10 6x 541 016 16 20 150,5 Ø → 357748</p> <p>61-37190-10 6x 541 016 17 20 150,5 Ø → 357749→</p>	<p>14-32068-01 6x 541 990 05 01 (4x)</p>	<p>71-33799-00 6x 541 016 03 21 → 084423</p> <p>71-35001-00 6x 541 016 04 21 → 084424→ → 155295</p>	<p>70-27214-00 24x 000 053 35 58</p>	<p>71-34033-00 (1) 6x 541 098 04 80</p> <p>71-35327-00 6x 541 142 04 80</p>	<p>71-34892-00 (1) 6x 541 014 03 22 → 012090</p> <p>71-34904-00 (2) 6x 541 014 07 22 → 012091→</p> <p>71-42464-00 (3) 6x 541 014 08 22</p>	<p>81-23301-60 (1) 6x 014 997 46 47 105x130 A FIL RD FPM</p> <p>81-23113-00 (1) 6x 013 997 14 47 120x140 AB SL LD FPM</p>
<p>01-34190-02 541 010 13 05 +541 010 11 20 (6x) +541 014 07 22 +000 053 35 58 (24x) → 012091→ → 084423</p>	<p>03-34190-03 457 010 42 20 → 155296→ → 357748</p> <p>03-34195-01 → 357748</p>		<p>15-76031-01 (3) 6x 541 011 00 59 +022 997 49 48 (2x) → 084654</p> <p>15-35170-01 (3) 6x 541 011 00 59 +541 997 09 45 (2x) → 084655→</p>			<p>71-34867-10 6x 457 016 02 21 → 155296→</p>				
<p>01-34190-05 541 010 13 05 +541 010 25 20 (6x) +541 014 07 22 +000 053 35 58 (24x) → 084424→ → 155295</p>	<p>03-37190-01 541 010 09 21 +541 016 13 20 → 357749→</p>									
<p>01-34190-06 541 010 13 05 +457 010 42 20 (6x) +541 014 07 22 +000 053 35 58 (24x) → 155296→ → 357748</p>	<p>03-37195-01 → 357749→</p>									

MERCEDES-BENZ

OM 502 LA.III OM 542.940 8 Cyl.

<p>01-34190-03 541 010 13 05 +541 010 11 20(8x) +542 014 03 22 +000 053 35 58(32x) → 012090</p>	<p>03-34190-01 541 010 11 20 → 084423</p> <p>03-34190-02 541 010 25 20 → 084424→ → 155295</p>	<p>08-33142-01 541 010 13 05</p>	<p>04-10098-01 </p> <p>15-31313-01 541 010 21 33</p>	<p>61-34190-10 8x 541 016 16 20 150,5 Ø → 357748</p>	<p>14-32068-01 8x 541 990 05 01 (4x)</p>	<p>71-33799-00 8x 541 016 03 21 → 084423</p> <p>71-35001-00 8x 541 016 04 21 → 084424→ → 155295</p>	<p>70-27214-00 32x 000 053 35 58</p>	<p>71-34033-00 8x 541 098 04 80</p> <p>71-35327-00 8x 541 142 04 80</p>	<p>71-34894-00 542 014 03 22 → 012090</p> <p>71-34906-00 542 014 04 22 → 012091→</p>	<p>81-23301-60 014 997 46 47 105x130 A FIL RD FPM</p> <p>81-23113-00 013 997 14 47 120x140 AB SL LD FPM</p>
<p>01-34190-04 541 010 13 05 +541 010 11 20 (8x) +542 014 04 22 +000 053 35 58 (32x) → 012091→ → 084423</p>	<p>03-34190-03 457 010 42 20 → 155296→ → 357748</p>	<p>15-76031-01 8x 541 011 00 59 +022 997 49 48 (2x) → 084654</p>	<p>15-35170-01 8x 541 011 00 59 +541 997 09 45 (2x) → 084655→</p>			<p>71-34867-10 8x 457 016 02 21 → 155296→</p>				
	<p>03-34195-01 → 357748</p>									
	<p>03-37195-01 → 357749→</p>									

MERCEDES-BENZ

OM 502 LA
OM 502 LA.III
OM 502 LA.III/3

OM 542.920
OM 542.921
OM 542.922
OM 542.925
OM 542.942
OM 542.944

8 Cyl.

<p>01-34190-03 541 010 13 05 +541 010 11 20(8x) +542 014 03 22 +000 053 35 58(32x) → 012090</p>	<p>03-34190-01 541 010 11 20 → 084423</p>	<p>08-33142-01 541 010 13 05</p>	<p>04-10098-01 541 010 21 33</p>	<p>61-34190-10 8x 541 016 16 20 150,5 0 → 357748</p>	<p>14-32068-01 8x 541 990 05 01 (4x)</p>	<p>71-33799-00 8x 541 016 03 21 → 084423</p>	<p>70-27214-00 32x 000 053 35 58</p>	<p>71-34033-00 8x 541 098 04 80</p>	<p>71-34894-00 542 014 03 22 → 012090</p>	<p>81-23301-60 014 997 46 47 105x130 A FIL RD FPM</p>
	<p>03-34190-02 541 010 25 20 → 084424→ → 155295</p>		<p>15-31313-01 541 010 21 33</p>	<p>61-37190-10 8x 541 016 17 20 150,5 0 → 357749→</p>		<p>71-35001-00 8x 541 016 04 21 → 084424→ → 155295</p>		<p>71-35327-00 8x 541 142 04 80</p>	<p>71-34906-00 542 014 04 22 → 012091→</p>	<p>81-23113-00 013 997 14 47 120x140 AB SL LD FPM</p>
<p>01-34190-04 541 010 13 05 +541 010 11 20 (8x) +542 014 04 22 +000 053 35 58 (32x) → 012091→ → 084423</p>	<p>03-34190-03 457 010 42 20 → 155296→ → 357748</p>		<p>15-76031-01 8x 541 011 00 59 +022 997 49 48 (2x) → 084654</p>			<p>71-34867-10 8x 457 016 02 21 → 155296→</p>				
<p>01-34190-07 541 010 13 05 +541 010 25 20 (8x) +542 014 04 22 +000 053 35 58 (32x) → 084424→ → 155295</p>	<p>03-34195-01 → 357748</p>		<p>15-35170-01 8x 541 011 00 59 +541 997 09 45 (2x) → 084655→</p>							
<p>01-34190-08 541 010 13 05 +457 010 42 20 (8x) +542 014 04 22 +000 053 35 58 (32x) → 155296→ → 357748</p>	<p>03-37190-01 541 010 09 21 +541 016 13 20 → 357749→</p>									
<p>01-34190-01 541 010 13 05 +541 010 11 20 (8x) +542 014 03 22 +000 053 35 58 (32x) → 012090</p>	<p>03-37195-01 → 357749→</p>									

















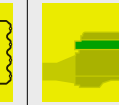
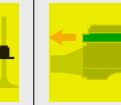
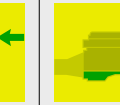

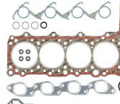

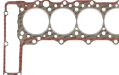

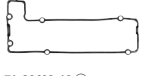

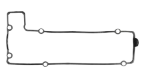







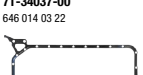



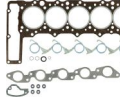



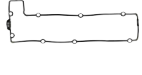













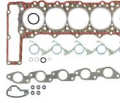

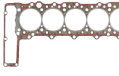

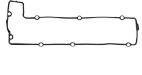



MERCEDES-BENZ

OM 502 LA
OM 502 LA.III
OM 502 LA.III/3
OM 542

OM 522.940
OM 522.941
OM 522.942
OM 522.943
OM 522.950
OM 542.923
OM 542.924
OM 542.926
OM 542.941
OM 542.943
OM 542.945
OM 542.946
OM 542.947
OM 542.948
OM 542.956
OM 542.957
OM 542.958
OM 542.960
OM 542.961
OM 542.962
OM 542.963
OM 542.964
OM 542.965
OM 542.966
OM 542.968
OM 542.969
OM 542.970
OM 542.971
OM 542.972
OM 542.975
OM 542.976
OM 542.900
OM 542.910
OM 542.911
OM 542.912
OM 542.925
OM 542.930
OM 542.960
OM 542.967
OM 542.970
OM 542.980
OM 542.990













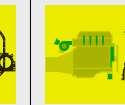
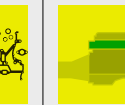
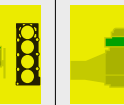

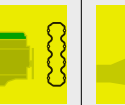
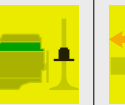
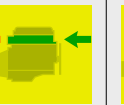
8 Cyl.

<p>01-34190-03 541 010 13 05 +541 010 11 20(8x) +542 014 03 22 +000 053 35 58(32x) ➡ 012090</p> <p>01-34190-04 541 010 13 05 +541 010 11 20 (8x) +542 014 04 22 +000 053 35 58 (32x) ➡ 012091→ ➡ 084423</p> <p>01-34190-07 541 010 13 05 +541 010 25 20 (8x) +542 014 04 22 +000 053 35 58 (32x) ➡ 084424→ ➡ 155295</p> <p>01-34190-08 541 010 13 05 +457 010 42 20 (8x) +542 014 04 22 +000 053 35 58 (32x) ➡ 155296→ ➡ 357748</p>	<p>03-34190-01 541 010 11 20 ➡ 084423</p> <p>03-34190-02 541 010 25 20 ➡ 084424→ ➡ 155295</p> <p>03-34190-03 457 010 42 20 ➡ 155296→ ➡ 357748</p> <p>03-34195-01 ➡ 357748</p> <p>03-37190-01 541 010 09 21 +541 016 13 20 ➡ 357749→</p> <p>03-37195-01 ➡ 357749→</p>	<p>08-33142-01 541 010 13 05</p>	<p>15-31313-01 Ⓢ 541 010 21 33</p> <p>15-76031-01 Ⓢ 8x 541 011 00 59 +022 997 49 48 (2x) ➡ 084654</p> <p>15-35170-01 Ⓢ 8x 541 011 00 59 +541 997 09 45 (2x) ➡ 084655→</p>	<p>61-34190-10 8x 541 016 16 20 150,5 Ø ➡ 357748</p> <p>61-37190-10 8x 541 016 17 20 150,5 Ø ➡ 357749→</p>	<p>14-32068-01 8x 541 990 05 01 (4x)</p>	<p>71-33799-00 8x 541 016 03 21 ➡ 084423</p> <p>71-35001-00 8x 541 016 04 21 ➡ 084424→ ➡ 155295</p> <p>71-34867-10 8x 457 016 02 21 ➡ 155296→</p>	<p>70-27214-00 32x 000 053 35 58</p>	<p>71-34033-00 Ⓢ 8x 541 098 04 80</p> <p>71-35327-00 Ⓢ 8x 541 142 04 80</p>	<p>71-34894-00 8x 542 014 03 22 ➡ 012090</p> <p>71-34906-00 Ⓢ 542 014 04 22 ➡ 012091→</p>	<p>81-23301-60 K↔ 014 997 46 47 105x130 A FIL RD FPM</p> <p>81-23113-00 K↔ 013 997 14 47 120x140 AB SL LD FPM</p>	



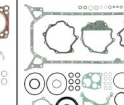
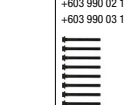
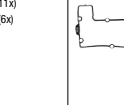
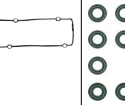



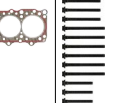



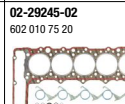
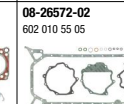

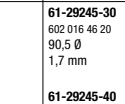

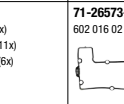
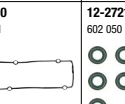
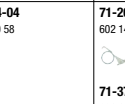
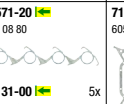
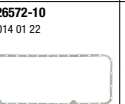
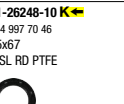
MERCEDES-BENZ												
OM 601 XIII/1	OM 601.900	4 Cyl.	<p>02-29120-01 601 010 48 20</p> 	<p>08-26204-02 601 010 48 05</p> 		<p>61-29120-20 601 016 33 20 90,5 Ø 1,8 mm</p> <p>61-29120-30 601 016 36 20 90,5 Ø 2 mm</p> 	<p>14-32031-01 603 990 01 10 (4x) +603 990 02 10 (9x) +603 990 03 10 (5x)</p> 	<p>71-26222-10  601 016 06 21</p>  <p>71-26492-10  601 016 07 21</p> 	<p>12-27214-03 102 050 00 58</p>  <p>70-27214-00 AS 4x 000 053 35 58</p>  <p>70-28424-10 ES 4x 102 053 02 58</p> 	<p>71-26206-20  601 141 11 80</p>  <p>71-26219-00  601 142 02 80</p> 	<p>71-26204-10 604 014 01 22</p>  <p>71-34037-00 646 014 03 22</p> 	<p>81-26248-10  014 997 70 46 45x67 A SL RD PTFE</p>  <p>81-26249-00  017 997 74 47 93x114 A SL LD FPM</p> 
OM 602 D 25	OM 602.990	5 Cyl.	<p>02-26570-06 602 010 66 20</p> 	<p>08-26572-02 602 010 55 05</p> 		<p>61-26570-50 602 016 31 20 88 Ø 1,75 mm</p> 	<p>14-32031-02 603 990 01 10 (5x) +603 990 02 10(11x) +603 990 03 10 (6x)</p> 	<p>71-26573-10 602 016 02 21</p> 	<p>12-27214-04 602 050 00 58</p>  <p>70-27214-00 AS 5x 000 053 35 58</p>  <p>70-28424-10 ES 5x 102 053 02 58</p> 	<p>71-26571-10  602 141 08 80</p>  <p>71-26611-00  602 142 00 80</p> 	<p>71-26572-10 605 014 01 22</p>  <p>71-34038-00 612 014 01 22</p> 	<p>81-26248-10  014 997 70 46 45x67 A SL RD PTFE</p>  <p>81-26249-00  017 997 74 47 93x114 A SL LD FPM</p> 
OM 602 D 29	OM 602.941 OM 602.948	5 Cyl.	<p>02-29245-01 602 010 67 20</p> 	<p>08-26572-02 602 010 55 05</p> 		<p>61-29245-30 602 016 46 20 90,5 Ø 1,7 mm</p> <p>61-29245-40 602 016 47 20 90,5 Ø 2 mm</p> 	<p>14-32031-02 603 990 01 10 (5x) +603 990 02 10(11x) +603 990 03 10 (6x)</p> 	<p>71-26574-10 602 016 03 21</p> 	<p>12-27214-04 602 050 00 58</p>  <p>70-27214-00 AS 5x 000 053 35 58</p>  <p>70-28424-10 ES 5x 102 053 02 58</p> 	<p>71-26571-20  602 141 08 80</p>  <p>71-26611-00  602 142 00 80</p> 	<p>71-26572-10 605 014 01 22</p>  <p>71-34038-00 612 014 01 22</p> 	<p>81-26248-10  014 997 70 46 45x67 A SL RD PTFE</p>  <p>81-26249-00  017 997 74 47 93x114 A SL LD FPM</p> 

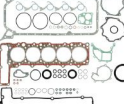
MERCEDES-BENZ

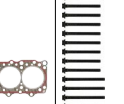



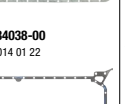





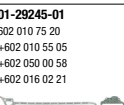
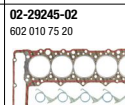
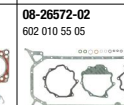
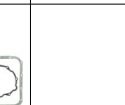
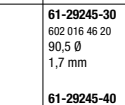
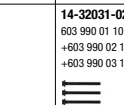
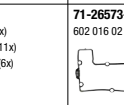
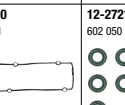
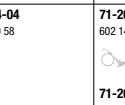
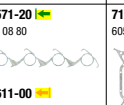

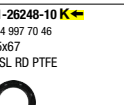
OM 602 D 29 OM 602.994 5 Cyl.

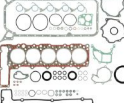
											
	02-29245-01 602 010 67 20	08-26572-02 602 010 55 05		61-29245-30 602 016 46 20 90,5 Ø 1,7 mm	14-32031-02 603 990 01 10 (5x) +603 990 02 10(11x) +603 990 03 10 (6x)	71-26573-10 602 016 02 21	12-27214-04 602 050 00 58	71-26571-20  602 141 08 80	71-26572-10 605 014 01 22	81-26248-10  014 997 70 46 45x67 A SL RD PTFE	
				61-29245-40 602 016 47 20 90,5 Ø 2 mm				71-26611-00  602 142 00 80		81-26249-00  017 997 74 47 93x114 A SL LD FPM	
							70-27214-00 AS 000 053 35 58	5x			
							70-28424-10 ES 102 053 02 58	5x			

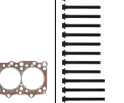

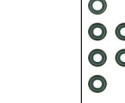







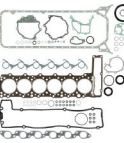

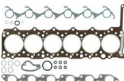

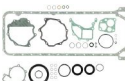

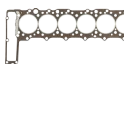

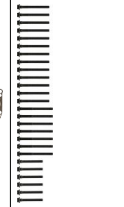





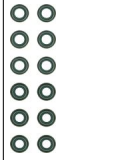

















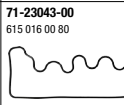

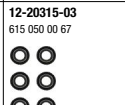

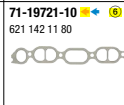

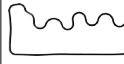
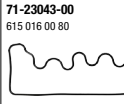

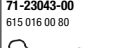



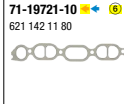



OM 602 DE 29 LA OM 602.981 5 Cyl.



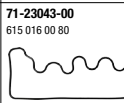



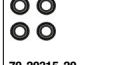
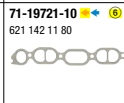









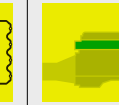
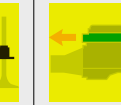
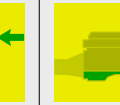

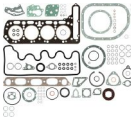
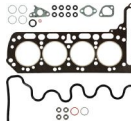











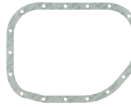
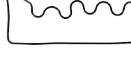









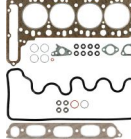

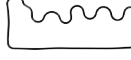









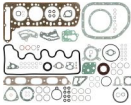
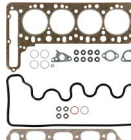



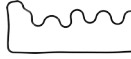



											
01-29245-01 602 010 75 20 +602 010 55 05 +602 050 00 58 +602 016 02 21	02-29245-02 602 010 75 20	08-26572-02 602 010 55 05		61-29245-30 602 016 46 20 90,5 Ø 1,7 mm	14-32031-02 603 990 01 10 (5x) +603 990 02 10(11x) +603 990 03 10 (6x)	71-26573-10 602 016 02 21	12-27214-04 602 050 00 58	71-26571-20  602 141 08 80	71-26572-10 605 014 01 22	81-26248-10  014 997 70 46 45x67 A SL RD PTFE	
				61-29245-40 602 016 47 20 90,5 Ø 2 mm				71-37131-00  601 141 00 60		81-90002-00  611 010 01 14	
							70-27214-00 AS 000 053 35 58	5x			
							70-28424-10 ES 102 053 02 58	5x			





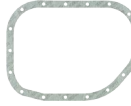











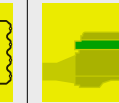
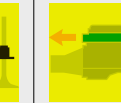
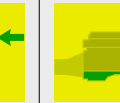

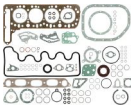
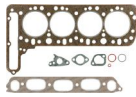







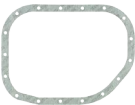

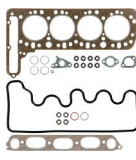

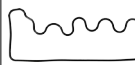





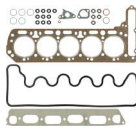







OM 602 DE 29 LA OM 602.989 5 Cyl.



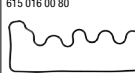













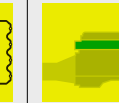
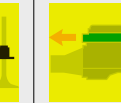
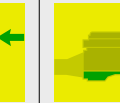

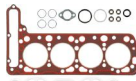

















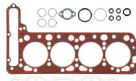

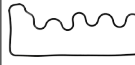



















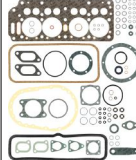

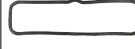



											
01-29245-01 602 010 75 20 +602 010 55 05 +602 050 00 58 +602 016 02 21	02-29245-02 602 010 75 20	08-26572-02 602 010 55 05		61-29245-30 602 016 46 20 90,5 Ø 1,7 mm	14-32031-02 603 990 01 10 (5x) +603 990 02 10(11x) +603 990 03 10 (6x)	71-26573-10 602 016 02 21	12-27214-04 602 050 00 58	71-26571-20  602 141 08 80	71-26572-10 605 014 01 22	81-26248-10  014 997 70 46 45x67 A SL RD PTFE	
				61-29245-40 602 016 47 20 90,5 Ø 2 mm				71-26611-00  602 142 00 80		81-90002-00  611 010 01 14	
							70-27214-00 AS 000 053 35 58	5x			
							70-28424-10 ES 102 053 02 58	5x			

MERCEDES-BENZ

<p>OM 603 D 30 A OM 603.950 6 Cyl.</p>	 01-27005-01 603 010 85 20 +603 010 67 05 +603 050 00 67 +603 016 02 21 	 02-27005-06 603 010 85 20 	 08-26232-02 603 010 67 05 	 61-27005-40 603 016 34 20 88,5 Ø 1,75 mm 61-27005-50 603 016 35 20 88,5 Ø 2 mm 	 14-32031-03 603 990 01 10 (6x) +603 990 02 10(13x) +603 990 03 10 (7x) 	 71-26999-00 603 016 02 21 	 71-27001-00 603 016 03 21 	 12-28424-03 603 050 00 67  70-27214-00 AS 6x 000 053 35 58 70-28424-10 ES 6x 102 053 02 58 	 71-27057-20  603 141 08 80  71-27058-00  603 142 00 80 	 71-26232-20 606 014 00 22 	 81-26248-10  014 997 70 46 45x67 A SL RD PTFE  81-26249-00  017 997 74 47 93x114 A SL LD FPM 
<p>OM 615 D 22 OM 615.910 OM 615.911 OM 615.918 OM 615.938 4 Cyl.</p>				 61-24060-40 615 016 20 20 89 Ø 1,75 mm 		 71-23043-00 615 016 00 80 	 12-20315-03 615 050 00 67  70-20315-20 8x 000 053 22 58 	 71-19721-10  621 142 11 80 	 71-21407-10 616 014 01 22 		
<p>OM 615 D 22 OM 615.914 4 Cyl.</p>						 71-23043-00 615 016 00 80 	 12-20315-03 615 050 00 67  70-20315-20 8x 000 053 22 58 	 71-19721-10  621 142 11 80 	 71-21407-10 616 014 01 22 		
<p>OM 615 D 22 OM 615.916 4 Cyl.</p>		 02-24060-05 615 010 97 21 +615 016 00 80 +615 050 00 67 		 61-24060-40 615 016 20 20 89 Ø 1,75 mm 		 71-23043-00 615 016 00 80 	 12-20315-03 615 050 00 67  70-20315-20 8x 000 053 22 58 	 71-19721-10  621 142 11 80 	 71-21407-10 616 014 01 22 		

MERCEDES-BENZ													
OM 615 D 22	OM 615.930	4 Cyl.	01-24060-03 615 010 97 21 +615 010 99 07 +615 050 00 67 	02-24060-05 615 010 97 21 +615 016 00 80 +615 050 00 67 			61-24060-40 615 016 20 20 89 Ø 1,75 mm 		71-23043-00 615 016 00 80 	12-20315-03 615 050 00 67     70-20315-20 000 053 22 58 	71-25883-20     615 142 04 80 	71-21407-10 616 014 01 22 	
OM 615 D 22 OM 616 D 24	OM 615.932 OM 616.915 OM 616.930 OM 616.931	4 Cyl.							71-23043-00 615 016 00 80 	12-20315-03 615 050 00 67     70-20315-20 000 053 22 58 	71-25883-20     615 142 04 80 		
OM 616 D 24	OM 616.911 OM 616.932 OM 616.942 OM 616.943	4 Cyl.		02-24110-04 616 010 52 21 +615 016 00 80 +615 050 00 67 			61-24110-40 616 016 20 20 92 Ø 1,75 mm 		71-23043-00 615 016 00 80 	12-20315-03 615 050 00 67     70-20315-20 000 053 22 58 	71-25883-20     615 142 04 80 		
OM 616 D 24	OM 616.918 OM 616.919	4 Cyl.	01-24110-03 616 010 52 21 +616 010 55 06 +615 050 00 67 	02-24110-04 616 010 52 21 +615 016 00 80 +615 050 00 67 	08-21407-09 616 010 55 06 		61-24110-40 616 016 20 20 92 Ø 1,75 mm 	14-32032-01 615 990 01 12 (4x) +615 990 02 12 (8x) +615 990 03 12 (6x) 	71-23043-00 615 016 00 80 	12-20315-03 615 050 00 67     70-20315-20 000 053 22 58 	71-25883-20     615 142 04 80 	71-21407-10 616 014 01 22 	81-17328-20  011 997 22 47 45x74,5/79,5 A SL RD FPM  71-19722-00  001 997 12 41 70x84 Graphit 

MERCEDES-BENZ													
OM 616 D 24	OM 616.960 OM 616.961	4 Cyl.	01-24110-03 616 010 52 21 +616 010 55 06 +615 050 00 67 	02-24110-05 616 010 52 21 	08-23724-02 616 010 56 06 		61-24110-40 616 016 20 20 92 Ø 1,75 mm 	14-32032-01 615 990 01 12 (4x) +615 990 02 12 (8x) +615 990 03 12 (6x) 	71-23043-00 615 016 00 80 		71-19721-10   621 142 11 80 	71-21407-10 616 014 01 22 	81-17328-20  011 997 22 47 45x74,5/79,5 A SL RD FPM 
OM 616 D 24	OM 616.962	4 Cyl.		02-24110-04 616 010 52 21 +615 016 00 80 +615 050 00 67 	08-23724-02 616 010 56 06 		61-24110-40 616 016 20 20 92 Ø 1,75 mm 		71-23043-00 615 016 00 80 	12-20315-03 615 050 00 67  70-20315-20 000 053 22 58  8x	71-25883-20   615 142 04 80 		
OM 617 D30	OM 617.933	5 Cyl.	01-24125-03 617 010 87 20 +617 010 11 05 +617 050 01 67 	02-24125-05 617 010 87 20 +617 016 01 80 +617 050 01 67 	08-21407-10 617 010 11 05 		61-24125-40 617 016 08 20 92 Ø 1,75 mm 		71-23796-00 617 016 01 80 	12-20315-04 617 050 01 67  70-20315-20 000 053 22 58  10x	71-23834-10   617 142 07 80 	71-20731-30   110 492 04 80 	
OM 621	OM 621.915 OM 621.931	4 Cyl.					61-19567-30 621 016 16 20 90 Ø 		71-23043-00 615 016 00 80 	12-20315-03 615 050 00 67  70-20315-20 000 053 22 58  8x	71-19721-10   621 142 11 80 		

MERCEDES-BENZ												
OM 621	OM 621.916	4 Cyl.	<p>01-19567-07</p> 	<p>02-19567-04 621 010 03 21</p> 		<p>61-19567-30 621 016 16 20 90 Ø</p> 		<p>71-23043-00 615 016 00 80</p> 	<p>12-20315-03 615 050 00 67</p>   <p>70-20315-20 000 053 22 58</p> 	<p>71-19721-10   </p> <p>621 142 11 80</p>  <p>41-73067-30   </p> <p>915035 000023</p>  <p>71-10474-10   </p> <p>621 492 00 81</p> 		
OM 621	OM 621.932	4 Cyl.	<p>01-19567-07</p> 	<p>02-19567-04 621 010 03 21</p> 		<p>61-19567-30 621 016 16 20 90 Ø</p> 		<p>71-23043-00 615 016 00 80</p> 	<p>12-20315-03 615 050 00 67</p>   <p>70-20315-20 000 053 22 58</p> 	<p>71-19721-10   </p> <p>621 142 11 80</p>  <p>41-73067-30   </p> <p>915035 000023</p>  <p>71-10474-10   </p> <p>621 492 00 81</p> 	<p>81-17328-20 </p> <p>011 997 22 47 45x74,5/79,5 A SL RD FPM</p>  <p>71-19722-00 </p> <p>001 997 12 41 78x84 Graphit</p> 	
OM 636	OM 636.914	4 Cyl.	<p>01-06858-08 636 010 09 21 +636 010 53 08 +636 053 00 60 (8x)</p> 	<p>02-06858-07 636 010 09 21 +636 016 01 80</p> 		<p>61-06858-30 636 016 12 20 76,5 Ø 1,3 mm</p> 		<p>71-15688-00 636 016 01 80</p> 	<p>40-77014-00 636 053 00 60</p> 	<p>71-09920-00  </p> <p>636 141 02 79</p>  <p>71-09918-40  </p> <p>636 142 06 80</p>  <p>71-10474-10   </p> <p>621 492 00 81</p> 	<p>71-15275-10 </p> <p>636 997 00 40 69x79 Graphit</p> 	

MERCEDES-BENZ

OM642 D30 LL OM 642.864 6 Cyl.

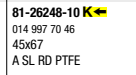
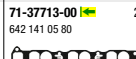
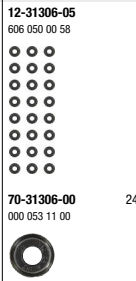
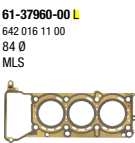
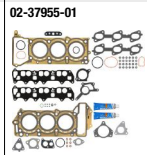
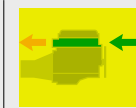

OM 662 D 29 OM 662.911 5 Cyl.

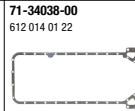
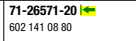
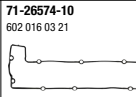
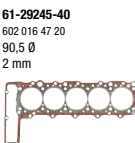
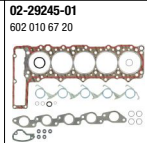

MERCEDES-BENZ

OM 904 LA
OM 900.915
OM 900.920
4 Cyl.
[NEW]

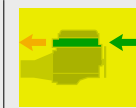

OM 904 LA
OM 904.905
OM 904.906
OM 904.907
4 Cyl.
[NEW]

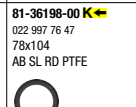
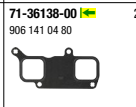
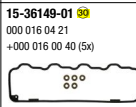
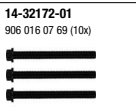
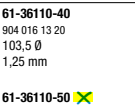
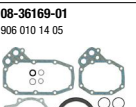
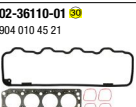
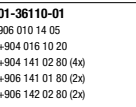

02-36110-01
904 010 45 21

02-36110-04

08-36169-01
906 010 14 05

61-36110-40
904 016 13 20
103,5 Ø
1,25 mm
61-36110-50
103,5 Ø
1,55 mm

14-32172-01
906 016 07 69 (10x)

15-36149-01
000 016 04 21
+000 016 00 40 (5x)
→ 519821

15-36149-02
000 016 04 21
+906 016 00 80
→ 519822→

12-34914-01
906 053 03 58 (12x)

70-34914-00
12x

71-36138-00
906 141 04 80

71-36168-00
904 141 02 80

71-36137-10
926 142 00 80

81-36198-00
022 997 76 47
78x104
AB SL RD PTFE

81-36197-00
021 997 53 47
115x140
AB SL LD PTFE

01-36110-01
906 010 14 05
+904 016 10 20
+904 141 02 80 (4x)
+906 141 01 80 (2x)
+906 142 02 80 (2x)

01-36110-02

02-36110-01
904 010 45 21

02-36110-02
904 010 80 20

02-36110-04

08-36169-01
906 010 14 05

04-10084-01

61-36110-40
904 016 13 20
103,5 Ø
1,25 mm
61-36110-50
103,5 Ø
1,55 mm

14-32172-01
906 016 07 69 (10x)

15-36149-01
000 016 04 21
+000 016 00 40 (5x)

15-36172-01
904 016 06 21
+906 016 00 80 (5x)

12-36154-01
906 053 01 58 (12x)
→ 039739

12-34914-01
906 053 03 58 (12x)
→ 039740→

70-36154-00
906 053 01 58
→ 039739

70-34914-00
→ 039740→

71-36138-00
906 141 04 80

71-36168-00
904 141 02 80

71-36137-10
926 142 00 80

71-36141-00
904 014 09 22

71-36161-00
904 014 07 22

81-36198-00
022 997 76 47
78x104
AB SL RD PTFE

81-36197-00
021 997 53 47
115x140
AB SL LD PTFE

MERCEDES-BENZ

OM 904 LA OM 904.909 4 Cyl.

[NEW]

<p>01-36110-01 906 010 14 05 +904 016 10 20 +904 141 02 80 (4x) +906 141 01 80 (2x) +906 142 02 80 (2x)</p> <p>01-36110-02</p>	<p>02-36110-01 </p> <p>904 010 45 21</p> <p>02-36110-02 </p> <p>904 010 80 20</p> <p>02-36110-04 </p>	<p>08-36169-01 906 010 14 05</p>	<p>04-10084-01 </p> <p> 067603</p>	<p>61-36110-40 904 016 13 20 103,5 Ø 1,25 mm</p> <p>61-36110-50 </p> <p>103,5 Ø 1,55 mm</p>	<p>14-32172-01 906 016 07 69 (10x)</p>	<p>15-36149-01 </p> <p>000 016 04 21 +000 016 00 40 (5x)</p> <p>15-36172-01 </p> <p>904 016 06 21 +906 016 00 80 (5x)</p>	<p>12-36154-01 906 053 01 58 (12x) 039739</p> <p>12-34914-01 906 053 03 58 (12x) 039740 →</p> <p>70-36154-00 12x 906 053 01 58 039739</p> <p>70-34914-00 12x 039740 →</p>	<p>71-36138-00 </p> <p>906 141 04 80</p> <p>71-36168-00 </p> <p>904 141 02 80</p> <p>71-36137-10 </p> <p>926 142 00 80</p>	<p>71-36141-00 </p> <p>904 014 09 22</p> <p>71-36161-00 </p> <p>904 014 07 22</p>	<p>81-36198-00 </p> <p>022 997 76 47 78x104 AB SL RD PTFE</p> <p>81-36197-00 </p> <p>021 997 53 47 115x140 AB SL LD PTFE</p>

MERCEDES-BENZ

OM 904 LA
 OM 904.910
 OM 904.916
 4 Cyl.
[NEW]

<p>01-36110-01 906 010 14 05 +904 016 10 20 +904 141 02 80 (4x) +906 141 01 80 (2x) +906 142 02 80 (2x)</p> <p>01-36110-02</p>	<p>02-36110-01 </p> <p>904 010 45 21</p> <p>02-36110-02 </p> <p>904 010 80 20</p> <p>02-36110-04 </p>	<p>08-36169-01 906 010 14 05</p>	<p>04-10084-01 </p> <p> 067603</p> <p>04-10041-01 </p> <p> 067604→</p>	<p>61-36110-40 904 016 13 20 103,5 Ø 1,25 mm</p> <p>61-36110-50 </p> <p>103,5 Ø 1,55 mm</p>	<p>14-32172-01 906 016 07 69 (10x)</p>	<p>15-36149-01 </p> <p>000 016 04 21 +000 016 00 40 (5x)</p> <p>15-36172-01 </p> <p>904 016 06 21 +906 016 00 80 (5x)</p>	<p>12-36154-01 906 053 01 58 (12x) 039739</p> <p>12-34914-01 906 053 03 58 (12x) 039740→</p> <p>70-36154-00 12x 906 053 01 58 039739</p> <p>70-34914-00 12x 039740→</p>	<p>71-36138-00 2x 906 141 04 80</p> <p>71-36168-00 4x 904 141 02 80</p> <p>71-36137-10 2x 926 142 00 80</p>	<p>71-36141-00 </p> <p>904 014 09 22</p> <p>71-36161-00 </p> <p>904 014 07 22</p>	<p>81-36198-00 </p> <p>022 997 76 47 78x104 AB SL RD PTFE</p> <p>81-36197-00 </p> <p>021 997 53 47 115x140 AB SL LD PTFE</p>

MERCEDES-BENZ

OM 904 LA OM 904.911 4 Cyl.

[NEW]

<p>01-36110-01 906 010 14 05 +904 016 10 20 +904 141 02 80 (4x) +906 141 01 80 (2x) +906 142 02 80 (2x)</p> <p>01-36110-02</p>	<p>02-36110-01 </p> <p>904 010 45 21</p> <p>02-36110-02 </p> <p>904 010 80 20</p> <p>02-36110-04 </p>	<p>08-36169-01 906 010 14 05</p>	<p>04-10084-01 </p> <p> 066058</p> <p>04-10041-01 </p> <p> 066059 → 136885</p>	<p>61-36110-40 904 016 13 20 103,5 Ø 1,25 mm</p> <p>61-36110-50 </p> <p>103,5 Ø 1,55 mm</p>	<p>14-32172-01 906 016 07 69 (10x)</p>	<p>15-36149-01 </p> <p>000 016 04 21 +000 016 00 40 (5x)</p> <p>15-36172-01 </p> <p>904 016 06 21 +906 016 00 80 (5x)</p>	<p>12-36154-01 906 053 01 58 (12x) 039739</p> <p>12-34914-01 906 053 03 58 (12x) 039740 →</p> <p>70-36154-00 12x 906 053 01 58 039739</p> <p>70-34914-00 12x 039740 →</p>	<p>71-36138-00 </p> <p>906 141 04 80</p> <p>71-36168-00 </p> <p>904 141 02 80</p> <p>71-36137-10 </p> <p>926 142 00 80</p>	<p>71-36141-00 </p> <p>904 014 09 22</p> <p>71-36161-00 </p> <p>904 014 07 22</p>	<p>81-36198-00 </p> <p>022 997 76 47 78x104 AB SL RD PTFE</p> <p>81-36197-00 </p> <p>021 997 53 47 115x140 AB SL LD PTFE</p>

MERCEDES-BENZ

OM 904 LA OM 904.922 4 Cyl.









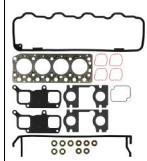

[NEW]

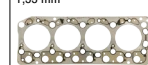
<p>01-36110-01 906 010 14 05 +904 016 10 20 +904 141 02 80 (4x) +906 141 01 80 (2x) +906 142 02 80 (2x)</p> <p>01-36110-02</p>	<p>02-36110-01 </p> <p>904 010 45 21</p> <p>02-36110-02 </p> <p>904 010 80 20</p> <p>02-36110-04 </p>	<p>08-36169-01 906 010 14 05</p>	<p>04-10084-01 </p> <p> 066058</p> <p>04-10041-01 </p> <p> 066059 →</p>	<p>61-36110-40 904 016 13 20 103,5 Ø 1,25 mm</p> <p>61-36110-50 </p> <p>103,5 Ø 1,55 mm</p>	<p>14-32172-01 906 016 07 69 (10x)</p>	<p>15-36149-01 </p> <p>000 016 04 21 +000 016 00 40 (5x)</p> <p>15-36172-01 </p> <p>904 016 06 21 +906 016 00 80 (5x)</p>	<p>12-36154-01 906 053 01 58 (12x) 039739</p> <p>12-34914-01 906 053 03 58 (12x) 039740 →</p> <p>70-36154-00 12x 906 053 01 58 039739</p> <p>70-34914-00 12x 039740 →</p>	<p>71-36138-00 </p> <p>906 141 04 80</p> <p>71-36168-00 </p> <p>904 141 02 80</p> <p>71-36137-10 </p> <p>926 142 00 80</p>	<p>71-36141-00 </p> <p>904 014 09 22</p> <p>71-36161-00 </p> <p>904 014 07 22</p>	<p>81-36198-00 </p> <p>022 997 76 47 78x104 AB SL RD PTFE</p> <p>81-36197-00 </p> <p>021 997 53 47 115x140 AB SL LD PTFE</p>

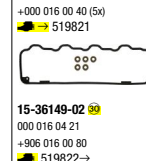
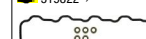
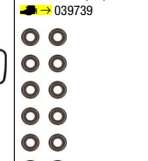
MERCEDES-BENZ

OM 904 LA
OM 904 LA - MTU
OM 904 LA.III/2
OM 904 LA.III/2
OM 904 LA.III/5

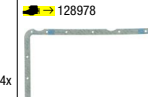
4 Cyl.
[NEW]

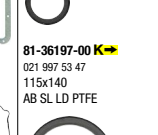
<p>01-36110-01 906 010 14 05 +904 016 10 20 +904 141 02 80 (4x) +906 141 01 80 (2x) +906 142 02 80 (2x)</p>  <p>01-36110-02</p>	<p>02-36110-01 </p> <p>904 010 45 21</p>  <p>02-36110-04 </p>	<p>08-36169-01 906 010 14 05</p> 		<p>61-36110-40 904 016 13 20 103,5 Ø 1,25 mm</p> <p>61-36110-50 103,5 Ø 1,55 mm</p> 	<p>14-32172-01 906 016 07 69 (10x)</p> 	<p>15-36149-01 000 016 04 21 +000 016 00 40 (5x) → 519821</p>  <p>15-36149-02 000 016 04 21 +906 016 00 80 → 519822→</p> 	<p>12-36154-01 906 053 01 58 (12x) → 039739</p>  <p>12-34914-01 906 053 03 58 (12x) → 039740→</p>  <p>70-36154-00 906 053 01 58 → 039739</p> <p>70-34914-00 → 039740→</p>	<p>71-36138-00 2x 906 141 04 80</p>  <p>71-36168-00 4x 904 141 02 80</p>  <p>71-36137-10 2x 926 142 00 80</p> 	<p>71-36141-00 904 014 09 22 → 128978</p>  <p>71-36161-00 904 014 07 22</p> 	<p>81-36198-00 022 997 76 47 78x104 AB SL RD PTFE</p>  <p>81-36197-00 021 997 53 47 115x140 AB SL LD PTFE</p> 

MERCEDES-BENZ

OM 904 LA
OM 904 LA.III/2



OM 904.915
OM 904.930
OM 904.941
OM 904.942
OM 904.943
OM 904.945
OM 904.949
OM 904.957
OM 904.962
OM 904.965
OM 904.966
OM 904.967
OM 904.968
OM 904.972

4 Cyl.
[NEW]



01-36110-01
906 010 14 05
+904 016 10 20
+904 141 02 80 (4x)
+906 141 01 80 (2x)
+906 142 02 80 (2x)



01-36110-02



02-36110-01
904 010 45 21

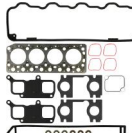

02-36110-02
904 010 80 20

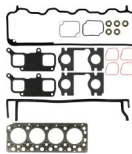

02-36110-04



08-36169-01
906 010 14 05



61-36110-40
904 016 13 20
103,5 Ø
1,25 mm

61-36110-50
103,5 Ø
1,55 mm



14-32172-01
906 016 07 69 (10x)



15-36149-01
000 016 04 21
+000 016 00 40 (5x)

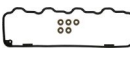

15-36172-01
904 016 06 21
+906 016 00 80 (5x)



12-36154-01
906 053 01 58 (12x)
 039739



12-34914-01
906 053 03 58 (12x)
 039740 →



70-36154-00 12x
906 053 01 58
 039739



70-34914-00 12x
 039740 →

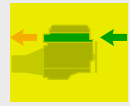

71-36138-00
906 141 04 80



71-36168-00
904 141 02 80



71-36137-10 2x
926 142 00 80



71-36141-00
904 014 09 22



71-36161-00
904 014 07 22



81-36198-00
022 997 76 47
78x104
AB SL RD PTFE



81-36197-00
021 997 53 47
115x140
AB SL LD PTFE



M 906 LAG

M 902.900
M 902.901
M 902.902
M 902.903
M 906.900
M 906.901
M 906.903

6 Cyl.



08-36169-01
906 010 14 05



61-36160-40
926 016 12 20
107,2 Ø
1,25 mm

61-36160-50
107,2 Ø
1,55 mm

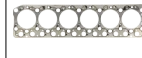

14-32172-02
906 016 07 69 (14x)



15-36159-01
906 016 06 21
+906 016 00 80 (7x)

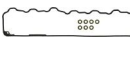

12-34914-02
906 053 03 58 (18x)



70-34914-00 18x



71-36138-00
906 141 04 80



71-36168-00
904 141 02 80



71-36137-10 3x
926 142 00 80



71-36139-00
906 014 09 22



81-36198-00
022 997 76 47
78x104
AB SL RD PTFE



81-36197-00
021 997 53 47
115x140
AB SL LD PTFE



MERCEDES-BENZ

OM 906 hLA
OM 906 HLA
OM 906 LA
OM 906 LA III/2
OM 906 LA III/3
OM 906 LA III/4

6 Cyl.
[NEW]

OM 902.910
OM 902.913
OM 902.914
OM 902.915
OM 902.916
OM 902.917
OM 902.918
OM 902.919
OM 902.920
OM 902.921
OM 902.922
OM 902.925
OM 902.926
OM 902.927
OM 902.930
OM 902.931
OM 902.932
OM 902.933
OM 902.934
OM 902.936
OM 902.937
OM 902.938
OM 902.939
OM 902.960
OM 902.961
OM 902.970
OM 902.971
OM 902.972
OM 906.910
OM 906.911
OM 906.912
OM 906.913
OM 906.914
OM 906.915
OM 906.916
OM 906.917
OM 906.918
OM 906.919
OM 906.920
OM 906.921
OM 906.922
OM 906.923
OM 906.924
OM 906.925
OM 906.926
OM 906.927
OM 906.928
OM 906.929
OM 906.930
OM 906.931
OM 906.932
OM 906.933
OM 906.934
OM 906.935
OM 906.936
OM 906.937
OM 906.938
OM 906.939
OM 906.940
OM 906.941
OM 906.944
OM 906.945
OM 906.946
OM 906.947
OM 906.948
OM 906.949
OM 906.950
OM 906.951
OM 906.952
OM 906.953
OM 906.954
OM 906.955
OM 906.956
OM 906.957
OM 906.958
OM 906.959
OM 906.960
OM 906.961
OM 906.962
OM 906.963
OM 906.964

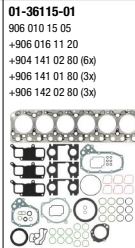

01-36115-02

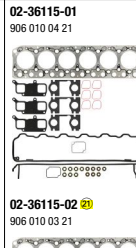

02-36115-03

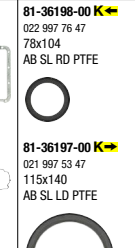
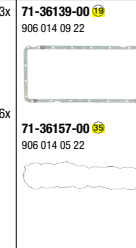
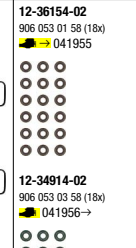
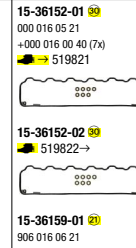
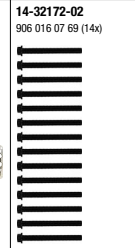
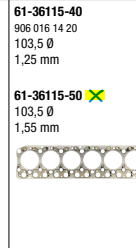

01-36115-01
906 010 15 05
+906 016 11 20
+904 141 02 80 (6x)
+906 141 01 80 (3x)
+906 142 02 80 (3x)

02-36115-01
906 010 04 21

08-36169-01
906 010 14 05

61-36115-40
906 016 14 20
103,5 Ø
1,25 mm

61-36115-50 ✕
103,5 Ø
1,55 mm

14-32172-02
906 016 07 69 (14x)

15-36152-01 Ⓢ
000 016 05 21
+000 016 00 40 (7x)
→ 519821

15-36152-02 Ⓢ
→ 519822→

15-36159-01 Ⓢ
906 016 06 21
+906 016 00 80 (7x)

12-36154-02
906 053 01 58 (18x)
→ 041955

12-34914-02
906 053 03 58 (18x)
→ 041956→

70-36154-00
906 053 01 58
→ 041955

70-34914-00
→ 041956→

71-36138-00 | → 3x
906 141 04 80

71-36168-00 | → 6x
904 141 02 80

71-36137-10 | → 3x
926 142 00 80



































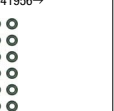

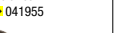

























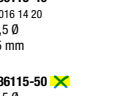







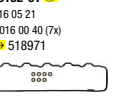
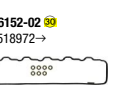





71-36139-00 Ⓢ
906 014 09 22

71-36157-00 Ⓢ
906 014 05 22

81-36198-00 K →
022 997 76 47
78x104
AB SL RD PTFE

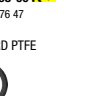
81-36197-00 K →
021 997 53 47
115x140
AB SL LD PTFE

MERCEDES-BENZ

<p>OM 906 hLA OM 906 HLA OM 906 LA OM 906 LA III/2 OM 906 LA III/3 OM 906 LA III/4</p>	 <p>01-36115-01 906 010 15 05 +906 016 11 20 +904 141 02 80 (6x) +906 141 01 80 (3x) +906 142 02 80 (3x)</p>  <p>01-36115-02</p>	<p>6 Cyl.</p> <p>[NEW]</p>	 <p>02-36115-01 906 010 04 21</p>  <p>02-36115-02  906 010 03 21</p> <p>02-36115-03</p>	 <p>08-36169-01 906 010 14 05</p> 	 <p>61-36115-40 906 016 14 20 103,5 Ø 1,25 mm</p> <p>61-36115-50  103,5 Ø 1,55 mm</p> 	 <p>14-32172-02 906 016 07 69 (14x)</p> 	 <p>15-36152-01  000 016 05 21 +000 016 00 40 (7x)  → 519821</p>  <p>15-36152-02   → 519822→</p>  <p>15-36159-01  906 016 06 21 +906 016 00 80 (7x)</p> 	 <p>12-36154-02 906 053 01 58 (18x)  → 041955</p>  <p>12-34914-02 906 053 03 58 (18x)  → 041956→</p>  <p>70-36154-00 906 053 01 58  → 041955</p>  <p>70-34914-00  → 041956→</p> 	 <p>71-36138-00  906 141 04 80</p>  <p>71-36168-00  904 141 02 80</p>  <p>71-36137-10 926 142 00 80</p> 	 <p>71-36139-00  906 014 09 22</p>  <p>71-36157-00  906 014 05 22</p> 	 <p>81-36198-00  022 997 76 47 78x104 AB SL RD PTFE</p>  <p>81-36197-00  021 997 53 47 115x140 AB SL LD PTFE</p> 
<p>OM 906 LA</p>	 <p>02-36115-01 906 010 04 21</p>  <p>02-36115-03</p>	<p>6 Cyl.</p> <p>[NEW]</p>	 <p>08-36169-01 906 010 14 05</p> 	 <p>61-36115-40 906 016 14 20 103,5 Ø 1,25 mm</p> <p>61-36115-50  103,5 Ø 1,55 mm</p> 	 <p>14-32172-02 906 016 07 69 (14x)</p> 	 <p>15-36152-01  000 016 05 21 +000 016 00 40 (7x)  → 518971</p>  <p>15-36152-02   → 518972→</p> 	 <p>12-34914-02 906 053 03 58 (18x)</p>  <p>70-34914-00</p> 	 <p>71-36138-00  906 141 04 80</p>  <p>71-36168-00  904 141 02 80</p>  <p>71-36137-10 926 142 00 80</p> 	 <p>71-36139-00  906 014 09 22</p>  <p>71-36157-00  906 014 05 22</p> 	 <p>81-36198-00  022 997 76 47 78x104 AB SL RD PTFE</p>  <p>81-36197-00  021 997 53 47 115x140 AB SL LD PTFE</p> 	

MERCEDES-BENZ

OM 924 LA OM 924.925 4 Cyl.

[NEW]



02-36145-01
924 010 03 20

08-36169-01
906 010 14 05

61-36145-40
924 016 11 20
107,2 Ø
1,25 mm

61-36145-50 ✕
107,2 Ø
1,55 mm

14-32172-01
906 016 07 69 (10x)

15-36149-01 Ⓞ
000 016 04 21
+000 016 00 40 (5x)
→ 519821

15-36149-02 Ⓞ
000 016 04 21
+906 016 00 80
→ 519822→

12-36154-01
906 053 01 58 (12x)
→ 039739

12-34914-01
906 053 03 58 (12x)
→ 039740→

70-36154-00 12x
906 053 01 58
→ 039739

70-34914-00 12x
→ 039740→

71-36138-00 | → 2x
906 141 04 80

71-36168-00 | → 4x
904 141 02 80

71-36141-00 Ⓞ
904 014 09 22
→ 128978

71-36161-00 Ⓞ
904 014 07 22

81-36198-00 K →
022 997 76 47
78x104
AB SL RD PTFE

81-36197-00 K →
021 997 53 47
115x140
AB SL LD PTFE

02-36145-02

MERCEDES-BENZ

OM 924 LA
OM 924 LA - MTU

OM 924.910
OM 924.911
OM 924.912
OM 924.913
OM 924.914
OM 924.915
OM 924.916
OM 924.917
OM 924.919
OM 924.920
OM 924.922
OM 924.923
OM 924.924
OM 924.927
OM 924.928
OM 924.929
OM 924.930
OM 924.931
OM 924.932
OM 924.933
OM 924.934
OM 924.935
OM 924.936
OM 924.937
OM 924.938
OM 924.940
OM 924.941
OM 924.942
OM 924.980
OM 924.981
OM 924.982
OM 924.985
OM 924.986
OM 924.987
OM 924.988
OM 924.989
OM 924.990
OM 924.991
OM 924.993
OM 924.994
OM 924.995
OM 924.996
OM 924.997
OM 924.998
OM 924.999

[NEW]

[NEW]

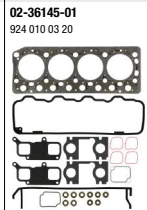
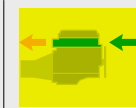

02-36145-02

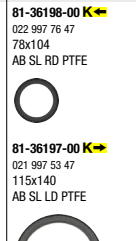
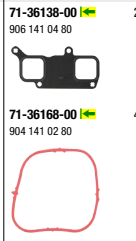
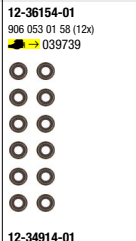
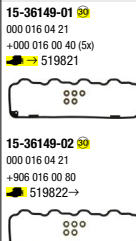
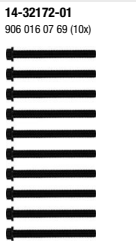
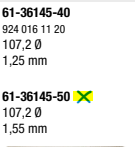

OM 926 LA

OM 926.933
OM 926.942
OM 926.950
OM 926.968



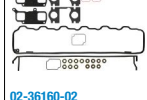
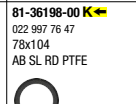
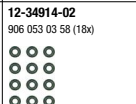
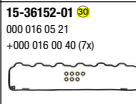
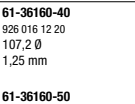
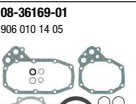
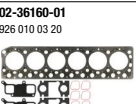



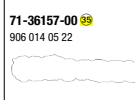
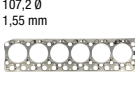













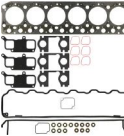













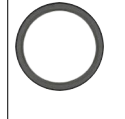
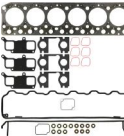





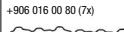



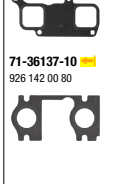



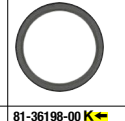
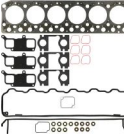



[NEW]









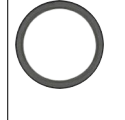





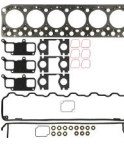







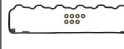















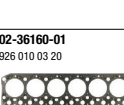
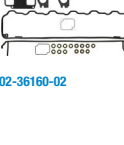
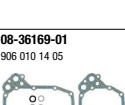

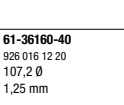

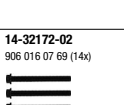

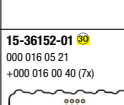

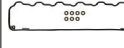
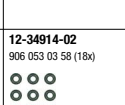





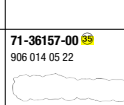







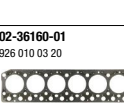

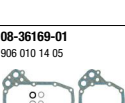

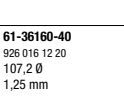

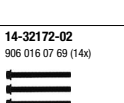

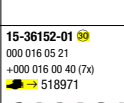

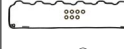

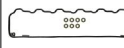















02-36160-02



MERCEDES-BENZ

<p>OM 926 LA</p> <p>OM 926.951 OM 926.960 OM 926.984 OM 926.987 OM 926.988 OM 926.995 OM 926.997</p> <p>6 Cyl.</p> <p>[NEW]</p>											
<p>OM 926 LA</p> <p>OM 926.952 OM 926.989 OM 926.991 OM 926.992 OM 926.993 OM 926.994 OM 926.998</p> <p>6 Cyl.</p> <p>[NEW]</p>		<p>02-36160-01 926 010 03 20</p>  <p>02-36160-02</p>	<p>08-36169-01 906 010 14 05</p> 		<p>61-36160-40 926 016 12 20 107,2 Ø 1,25 mm</p> <p>61-36160-50 107,2 Ø 1,55 mm</p> 	<p>14-32172-02 906 016 07 69 (14x)</p> 	<p>15-36152-01 </p> <p>000 016 05 21 +000 016 00 40 (7x)</p> 	<p>12-34914-02 906 053 03 58 (18x)</p> 	<p>71-36138-00 </p> <p>906 141 04 80</p> <p>71-36168-00 </p> <p>904 141 02 80</p> <p>71-36137-10 </p> <p>926 142 00 80</p> 	<p>71-36139-00 906 014 09 22</p> 	<p>81-36198-00 </p> <p>022 997 76 47 78x104 AB SL RD PTFE</p> <p>81-36197-00 </p> <p>021 997 53 47 115x140 AB SL LD PTFE</p> 
<p>OM 926 LA</p> <p>OM 926.961 OM 926.963</p> <p>6 Cyl.</p> <p>[NEW]</p>		<p>02-36160-01 926 010 03 20</p>  <p>02-36160-02</p>	<p>08-36169-01 906 010 14 05</p> 		<p>61-36160-40 926 016 12 20 107,2 Ø 1,25 mm</p> <p>61-36160-50 107,2 Ø 1,55 mm</p> 	<p>14-32172-02 906 016 07 69 (14x)</p> 	<p>15-36152-01 </p> <p>000 016 05 21 +000 016 00 40 (7x)</p>  <p>15-36159-01 </p> <p>906 016 06 21 +906 016 00 80 (7x)</p> 	<p>12-34914-02 906 053 03 58 (18x)</p> 	<p>71-36138-00 </p> <p>906 141 04 80</p> <p>71-36137-10 </p> <p>926 142 00 80</p> 	<p>71-36139-00 906 014 09 22</p> 	<p>81-36198-00 </p> <p>022 997 76 47 78x104 AB SL RD PTFE</p> <p>81-36197-00 </p> <p>021 997 53 47 115x140 AB SL LD PTFE</p> 
<p>OM 926 LA</p> <p>OM 926.969 OM 926.974 OM 926.975 OM 926.996 OM 926.999</p> <p>6 Cyl.</p> <p>[NEW]</p>		<p>02-36160-01 926 010 03 20</p>  <p>02-36160-02</p>	<p>08-36169-01 906 010 14 05</p> 		<p>61-36160-40 926 016 12 20 107,2 Ø 1,25 mm</p> <p>61-36160-50 107,2 Ø 1,55 mm</p> 		<p>15-36152-01 </p> <p>000 016 05 21 +000 016 00 40 (7x)</p> 	<p>12-34914-02 906 053 03 58 (18x)</p>  <p>70-34914-00 18x</p> 	<p>71-36138-00 </p> <p>906 141 04 80</p> <p>71-36137-10 </p> <p>926 142 00 80</p> 	<p>71-36157-00 </p> <p>906 014 05 22</p> 	<p>81-36198-00 </p> <p>022 997 76 47 78x104 AB SL RD PTFE</p> <p>81-36197-00 </p> <p>021 997 53 47 115x140 AB SL LD PTFE</p> 

MERCEDES-BENZ

<p>OM 926 LA</p> <p>OM 926.973 OM 926.976 OM 926.990</p> <p>6 Cyl.</p> <p>[NEW]</p>		 <p>02-36160-01 926 010 03 20</p>  <p>02-36160-02</p>	 <p>08-36169-01 906 010 14 05</p> 		 <p>61-36160-40 926 016 12 20 107,2 Ø 1,25 mm</p> <p>61-36160-50 107,2 Ø 1,55 mm</p> 		 <p>15-36152-01  000 016 05 21 +000 016 00 40 (7x)</p> 	 <p>12-34914-02 906 053 03 58 (18x)</p>  <p>70-34914-00 18x</p> 	 <p>71-36138-00  3x 906 141 04 80</p>  <p>71-36137-00 3x 906 142 11 80</p> 	 <p>71-36157-00  906 014 05 22</p> 	 <p>81-36198-00  022 997 76 47 78x104 AB SL RD PTFE</p>  <p>81-36197-00  021 997 53 47 115x140 AB SL LD PTFE</p> 
<p>OM 926 LA</p> <p>OM 926.985 OM 926.986</p> <p>6 Cyl.</p> <p>[NEW]</p>		 <p>02-36160-01 926 010 03 20</p>  <p>02-36160-02</p>	 <p>08-36169-01 906 010 14 05</p> 		 <p>61-36160-40 926 016 12 20 107,2 Ø 1,25 mm</p> <p>61-36160-50 107,2 Ø 1,55 mm</p> 	 <p>14-32172-02 906 016 07 69 (14x)</p> 	 <p>15-36152-01  000 016 05 21 +000 016 00 40 (7x)</p> 	 <p>12-34914-02 906 053 03 58 (18x)</p> 	 <p>71-36138-00  3x 906 141 04 80</p>  <p>71-36137-10 3x 926 142 00 80</p> 	 <p>71-36157-00  906 014 05 22</p> 	 <p>81-36198-00  022 997 76 47 78x104 AB SL RD PTFE</p>  <p>81-36197-00  021 997 53 47 115x140 AB SL LD PTFE</p> 
<p>OM 926 LA OM 926 LA - MTU</p> <p>OM 925.920 OM 925.960 OM 926.910 OM 926.911 OM 926.912 OM 926.913 OM 926.914 OM 926.915 OM 926.916 OM 926.917 OM 926.918 OM 926.919 OM 926.920 OM 926.921 OM 926.924 OM 926.925 OM 926.926 OM 926.927 OM 926.928 OM 926.929 OM 926.930 OM 926.932 OM 926.934 OM 926.935 OM 926.936 OM 926.937 OM 926.938 OM 926.939 OM 926.940 OM 926.941 OM 926.944 OM 926.945 OM 926.946 OM 926.947 OM 926.948 OM 926.949 OM 926.959 OM 926.970 OM 926.971 OM 926.972</p> <p>6 Cyl.</p> <p>[NEW]</p>		 <p>02-36160-01 926 010 03 20</p>  <p>02-36160-02</p>	 <p>08-36169-01 906 010 14 05</p> 		 <p>61-36160-40 926 016 12 20 107,2 Ø 1,25 mm</p> <p>61-36160-50 107,2 Ø 1,55 mm</p> 	 <p>14-32172-02 906 016 07 69 (14x)</p> 	 <p>15-36152-01  000 016 05 21 +000 016 00 40 (7x)  → 518971</p>  <p>15-36152-02   518972→</p> 	 <p>12-36154-02 906 053 01 58 (18x)  → 041955</p>  <p>12-34914-02 906 053 03 58 (18x)  041956→</p>  <p>70-36154-00 906 053 01 58  → 041955</p>  <p>70-34914-00  041956→</p> 	 <p>71-36138-00  3x 906 141 04 80</p>  <p>71-36168-00  6x 904 141 02 80</p>  <p>71-36137-10 3x 926 142 00 80</p> 	 <p>71-36139-00  906 014 09 22</p>  <p>71-36157-00  906 014 05 22</p> 	 <p>81-36198-00  022 997 76 47 78x104 AB SL RD PTFE</p>  <p>81-36197-00  021 997 53 47 115x140 AB SL LD PTFE</p> 

MERCEDES-BENZ

OM 934 LA
OM 934.911
OM 934.912
OM 934.913
OM 934.914
OM 934.971
OM 934.972
OM 934.974

4 Cyl.

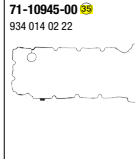
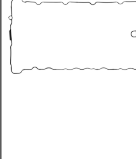
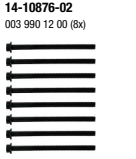
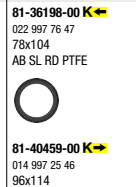
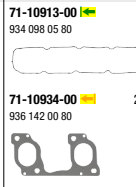
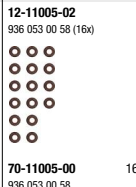
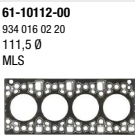
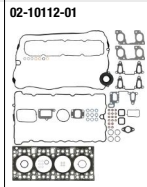
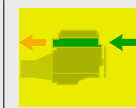

OM 934 LA
OM 934.976
OM 934.978

4 Cyl.

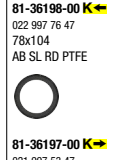
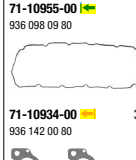
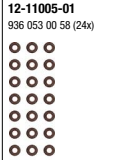
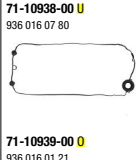
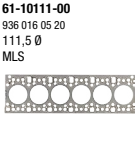
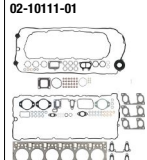
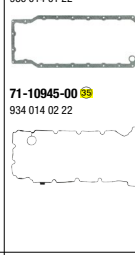
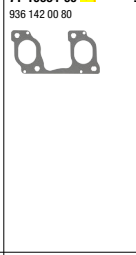
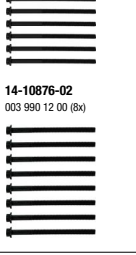
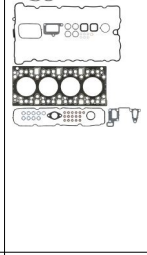
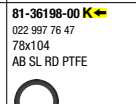
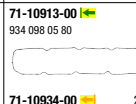
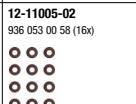
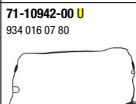
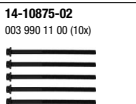
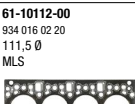
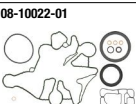
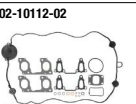

OM 936
OM 936.915
OM 936.919
OM 936.923

6 Cyl.

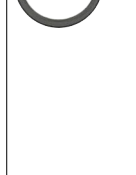
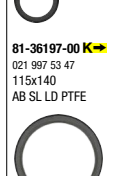
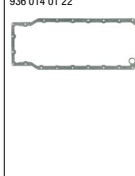
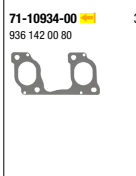
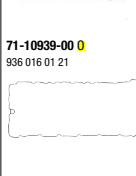
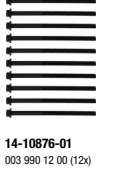
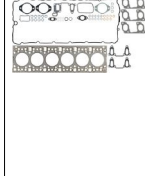
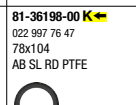
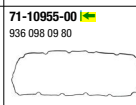
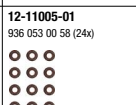
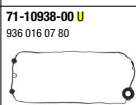
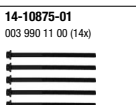
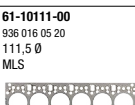
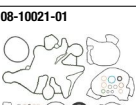
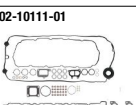

MERCEDES-BENZ

OM 936
OM 936 H
OM 936.971
OM 936.972
OM 936.973
OM 936.974
OM 936.980

6 Cyl.

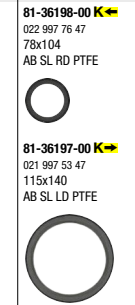
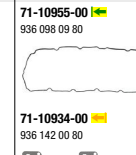
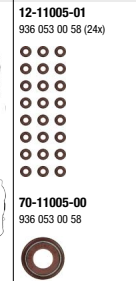
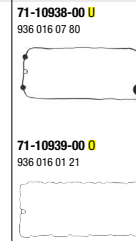
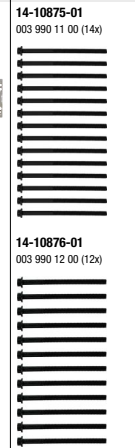
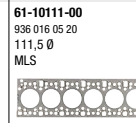
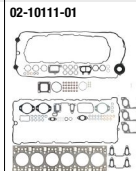
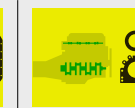
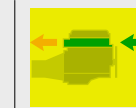

OM 936
OM 936 LA
OM 936.910
OM 936.912
OM 936.913
OM 936.916

6 Cyl.

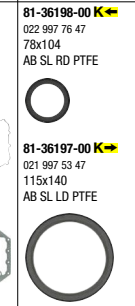
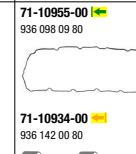
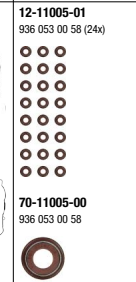
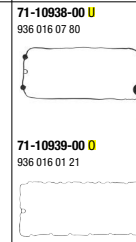
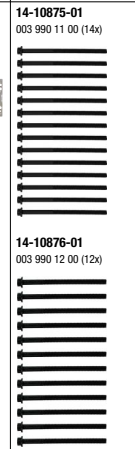
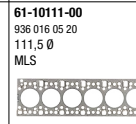
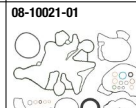
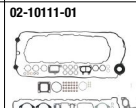

MERCEDES-BENZ

OM 936 LA OM 936.917 6 Cyl.

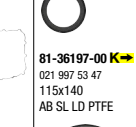
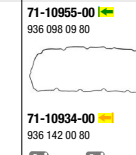
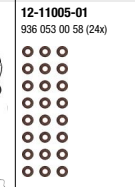
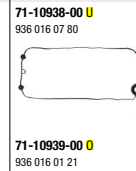
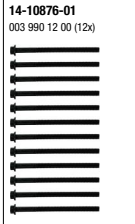
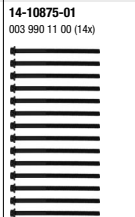
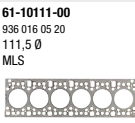
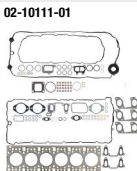
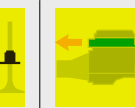
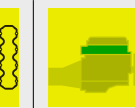
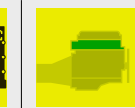



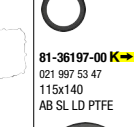
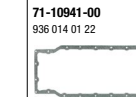
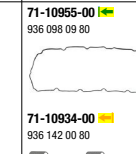
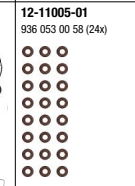
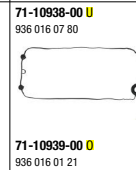
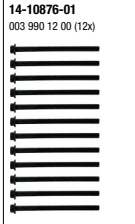
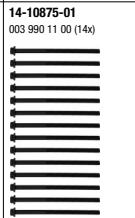
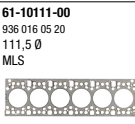



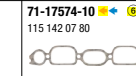
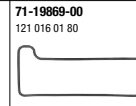















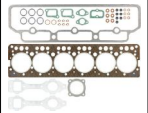









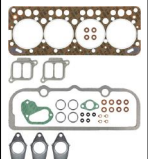







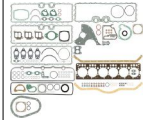
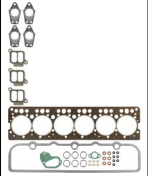

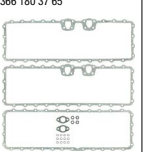





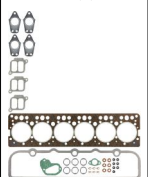

OM 936 LA OM 936.975 OM 936.977 6 Cyl.

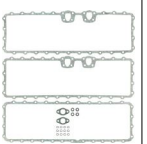















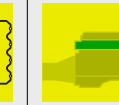
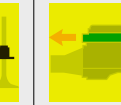
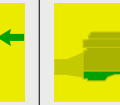

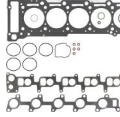
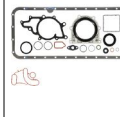





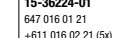
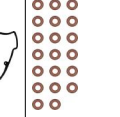













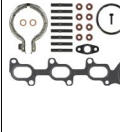

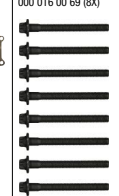

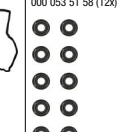





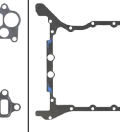



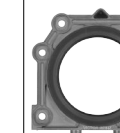
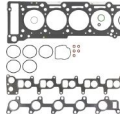
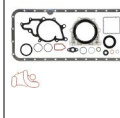



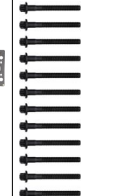

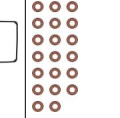



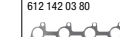





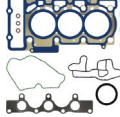
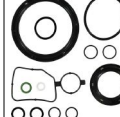

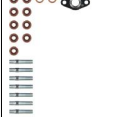

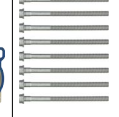





M 121.943 4 Cyl.



MERCEDES-BENZ

											
<p>OM 341.900 OM 341.913 OM 341.933 OM 341.937 OM 341.939 OM 341.943 OM 341.947 OM 341.950 OM 341.996</p>	<p>01-27350-09</p>	<p>02-27350-05 352 010 26 21 +346 017 01 60 (6x) +016 997 82 48 (6x)</p> 			<p>61-27350-40 366 016 06 20 98,5 Ø 1,3 mm</p> 	<p>14-32063-02 366 990 03 01 (25x)</p> 	<p>71-19137-40 352 016 09 21</p> 	<p>70-22026-00 ES 6x 352 053 02 96 794938</p>  <p>70-23824-00 AS 6x 360 053 00 96 794938</p>  <p>70-27262-00 AS 6x 366 053 01 58 794939→</p>  <p>70-27283-00 ES 6x 366 053 00 58 794939→</p> 	<p>71-24004-10 2x 352 142 04 80</p> 	<p>10-12413-02 352 010 08 80</p> 	
<p>OM 384.907 OM 384.908</p>		<p>02-26305-04 364 010 53 20 +346 017 01 60 (4x) +016 997 82 48 (4x)</p> 	<p>08-25508-08 364 010 22 08</p> 		<p>61-26305-60 364 016 07 20 98,5 Ø 1,3 mm</p> 		<p>71-26306-30 364 016 01 21</p> 	<p>70-27262-00 AS 6x 366 053 01 58</p>  <p>70-27283-00 ES 6x 366 053 00 58</p> 	<p>71-26323-30 2x 366 141 05 80</p>  <p>71-26283-00 3x 366 142 04 80</p> 	<p>10-13034-01 364 010 01 80</p> 	
<p>OM 386.906</p>	<p>01-27350-07</p> 	<p>02-27350-04 366 010 61 20 +346 017 01 60 (6x) +016 997 82 48 (6x)</p> 	<p>08-25508-07 366 010 44 08</p> 	<p>13-15598-03 366 180 37 65</p> 	<p>61-27350-40 366 016 06 20 98,5 Ø 1,3 mm</p> 		<p>71-26284-30 366 016 03 21</p> 	<p>70-27262-00 AS 6x 366 053 01 58</p>  <p>70-27283-00 ES 6x 366 053 00 58</p> 	<p>71-26323-30 3x 366 141 05 80</p>  <p>71-26283-00 4x 366 142 04 80</p> 	<p>10-12413-02 352 010 08 80</p> 	
<p>OM 386.950 OM 386.951 OM 386.952 OM 386.980 OM 386.981 OM 386.983</p>		<p>02-27350-06 366 010 71 20 +346 017 01 60 (6x) +016 997 82 48 (6x)</p> 	<p>08-25508-07 366 010 44 08</p> 	<p>13-15598-03 366 180 37 65</p> 	<p>61-27350-40 366 016 06 20 98,5 Ø 1,3 mm</p> 		<p>71-26284-30 366 016 03 21</p> 	<p>70-27262-00 AS 6x 366 053 01 58</p>  <p>70-27283-00 ES 6x 366 053 00 58</p> 	<p>71-26323-20 3x 366 141 10 80</p>  <p>71-26283-00 4x 366 142 04 80</p> 	<p>10-12413-02 352 010 08 80</p> 	

MERCEDES-BENZ												
OM 612.983	5 Cyl.		<p>02-35160-01 612 010 18 20</p> 	<p>08-34038-01 612 010 14 05</p> 	<p>04-10044-01 </p> 	<p>61-35160-10 647 016 06 20 89 Ø 1,2 mm MLS</p> 	<p>14-32109-02 611 990 13 22 (12x)</p> 	<p>15-40018-01 612 016 00 21 +611 016 02 21 (5x) → 50813930</p>  <p>15-36224-01 647 016 01 21 +611 016 02 21 (5x) → 50813931 →</p> 	<p>12-29491-04 000 053 42 58 (20x)</p>  <p>70-29491-00 000 053 42 58</p> 	<p>71-35216-00  612 141 01 80</p>  <p>71-35300-00  612 142 03 80</p> 	<p>71-34038-00 612 014 01 22</p> 	<p>81-26248-10  014 997 70 46 45x67 A SL RD PTFE</p>  <p>81-90002-00  611 010 01 14</p> 
OM 639.939	3 Cyl.		<p>02-10009-01</p> 	<p>08-10016-01</p> 	<p>04-10227-01 </p> 	<p>61-37545-00</p> 	<p>14-32212-03 000 016 00 69 (8x)</p> 	<p>15-39017-01</p> 	<p>12-31306-08 000 053 51 58 (12x)</p>  <p>70-31306-00 000 053 11 00</p> 	<p>71-39018-00  612 141 01 80</p>  <p>71-39027-00  612 142 03 80</p> 	<p>71-39031-00</p> 	<p>81-10401-00  000 997 19 08 40x62 A SL RD FPM</p>  <p>81-10435-00  640 010 15 68 90 Ø LD PTFE</p> 
OM 647.981	5 Cyl.		<p>02-35160-01 612 010 18 20</p> 	<p>08-34038-01 612 010 14 05</p> 	<p>04-10044-01 </p> 	<p>61-35160-10 647 016 06 20 89 Ø 1,2 mm MLS</p> 	<p>14-32109-02 611 990 13 22 (12x)</p> 	<p>15-36224-01 647 016 01 21 +611 016 02 21 (5x)</p> 	<p>12-29491-04 000 053 42 58 (20x)</p>  <p>70-29491-00 000 053 42 58</p> 	<p>71-35216-00  612 141 01 80</p>  <p>71-35300-00  612 142 03 80</p> 	<p>71-34038-00 612 014 01 22</p> 	<p>81-26248-10  014 997 70 46 45x67 A SL RD PTFE</p>  <p>81-90002-00  611 010 01 14</p> 
OM 660.950	3 Cyl.		<p>02-33165-01</p> 	<p>08-35224-01</p> 	<p>04-10052-01 </p> 	<p>61-33165-00 660 016 01 20 66,5 Ø MLS</p> 	<p>14-32173-01</p> 	<p>18-33173-50 000 1421 V003</p>  <p>71-36807-00 660 016 00 00</p> 	<p>12-31306-13</p>  <p>70-31306-00 000 053 11 00</p> 	<p>71-36503-00  166 997 02 46 40x62 A RD PTFE ACM</p>  <p>71-33226-00  000 4613 V002</p> 	<p>70-31414-10</p> 	<p>81-35035-00  166 997 02 46 40x62 A RD PTFE ACM</p>  <p>81-35051-00  166 997 01 46 80x100 A LD PTFE ACM</p> 

Haftungsausschluss

(für Katalog)

Alle Angaben in unserem Katalog wurden von uns sorgfältig geprüft, sind jedoch unverbindlich. Ersatzansprüche wegen Katalogangaben werden von uns nicht anerkannt. Der Käufer ist selbst verpflichtet, zu prüfen, ob unsere Teile für seine Zwecke geeignet sind. In allen Zweifelsfällen sollte Rücksprache mit unserem technischen Kundendienst erfolgen **Tel. +49 731 7046 999**.

Technische Weiterentwicklungen oder Änderungen bleiben vorbehalten, soweit damit keine Nachteile für den Kunden verbunden sind.

Angaben, Namens- und Markenzeichen, Beschreibungen, Nummern von Fahrzeugnummern und Herstellerzeichen, Original-Ersatzteilnummern der Fahrzeug- und Motorenhersteller u. a. sind ausschließlich für interne Zwecke gedacht. Solche Kennzeichnungen dürfen Fahrzeugbesitzern gegenüber nicht verwendet werden.

Wir weisen ausdrücklich darauf hin, dass alle von uns gelieferten Teile von geschultem Fachpersonal einzubauen sind. Reinz haftet für Fehler in diesem Katalog nur, wenn diese für den Kunden nicht offenbar erkennbar sind sowie nur bei Vorsatz und grober Fahrlässigkeit von Reinz, eines Vertreters oder eines Erfüllungsgehilfen. Dieser Haftungsausschluss gilt nicht im Rahmen

des Anwendungsbereichs des Produkthaftungsgesetzes und nicht bei Verletzung von Körper, Leben und Gesundheit, sowie bei der Verletzung von sog. Kardinalpflichten. Darüber hinaus ist unsere Haftung für Schäden, insbesondere für Personen-, Sach- oder Vermögensschäden, die unmittelbar oder mittelbar im Zusammenhang mit der Nutzung dieses Kataloges auftreten, sowie für nicht voraussehbare Schäden ausgeschlossen.

Reinz ist Inhaber aller Schutzrechte an den in diesem Katalog gespeicherten Daten. Kopie, Nachdruck, ganze oder teilweise Übernahme der Inhalte und Vervielfältigung, auch auszugsweise, ist nur mit unserer vorheriger schriftlicher Zustimmung sowie mit unserem Urheberrechtsvermerk zulässig.

Für Bestellungen, welche ab dem Erscheinungsdatum eines neuen Katalogs getätigt werden, sind alleine die Angaben des neuen Katalogs maßgeblich. Auf Angaben im Vorkatalog kann bei Neubestellungen nicht mehr zurückgegriffen werden.

Sofern Sie noch Fragen haben, bitten wir Sie, sich mit uns in Verbindung zu setzen.

VictorReinz.com/AGB

Exclusion of Liability

(for catalog)

All details in our catalog have been thoroughly checked by us but are however not binding. Right to damages on account of catalog details will not be recognized. The purchaser is obliged to check if our parts are suitable for their use. In all doubtful cases, the purchaser should consult our technical customer service under **+49 731 7046 999**.

We reserve the right to further technical developments or changes as long as no disadvantage for the customer results.

Details, name and trademarks, descriptions, numbers from vehicle numbers and manufacturer symbols, original vehicle replacement part numbers and engine manufacturer etc. are solely for internal use. Such labels must not be used with vehicle owners.

We specifically point out that all parts supplied by us must be assembled by trained specialists.

Reinz is liable for mistakes in this catalog only when they are not clearly recognizable for the customer, as well as by intent or gross negligence on the part of Reinz, its representative or vicarious agent. This exclusion of liability does not apply within the framework of the field of

application of the product liability laws and not by bodily harm, life and health, as well as by violation of cardinal duties. In addition, our liability for damages, especially personal, property or financial damages that occur directly or indirectly as a result of the use of this catalog, as well as non-foreseeable damages are excluded.

Reinz is the owner of all patent rights on the data stored in this catalog. Copies, reprints, whole or partial takeover of the contents and duplication even in excerpts are only permissible with our prior written approval, as well as with our copyright note.

For orders placed after the publication date of a new catalog, only the details in the new catalog are binding and no fall back to details in the previous catalog is possible.

In case you have further questions, do not hesitate to contact us.

VictorReinz.com/AGB

VictorReinz.com

reinz.info@dana.com

Technical Hotline +49 (0)731 7046-9 99

REINZ-Dichtungs-GmbH

Reinzstrasse 3-7
89233 Neu-Ulm
Germany
+49 (0)731 7046-0

VICTOR REINZ[®]

