

VICTOR REINZ®



**RENAULT
Q3 / 2023**



VictorReinz.com/online-catalog

Victor Reinz®

at a Glance



Online Catalog

VictorReinz.com/online-catalog



Newsletter

VictorReinz.com/EN/News/Newsletter.aspx?region



Youtube

www.youtube.com/user/VictorReinzSealingEN



Catalog News

VictorReinz.com/news



Technical Service Information

VictorReinz.com/tsi



Facebook

www.facebook.com/VictorReinzParts



Just seal it!

VictorReinz.com/jsi



Technical Datasheet

VictorReinz.com/jsi-datasheet



LinkedIn

www.linkedin.com/showcase/victor-reinz-emea



Safety Datasheet

VictorReinz.com/jsi-datasheet



Homepage

VictorReinz.com

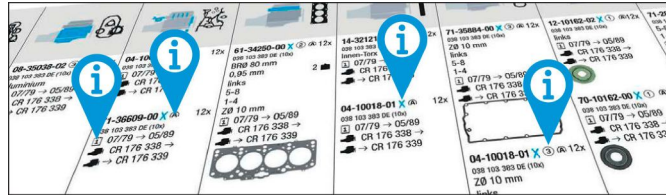

[VictorReinz.com/catalog-info](https://www.victorreinz.com/catalog-info)

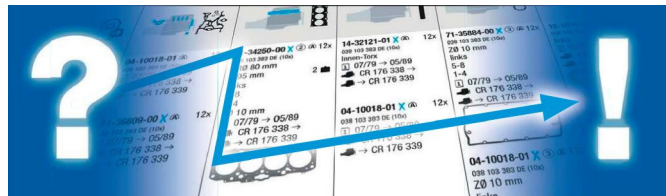

[VictorReinz.com/catalog-how-to-use](https://www.victorreinz.com/catalog-how-to-use)

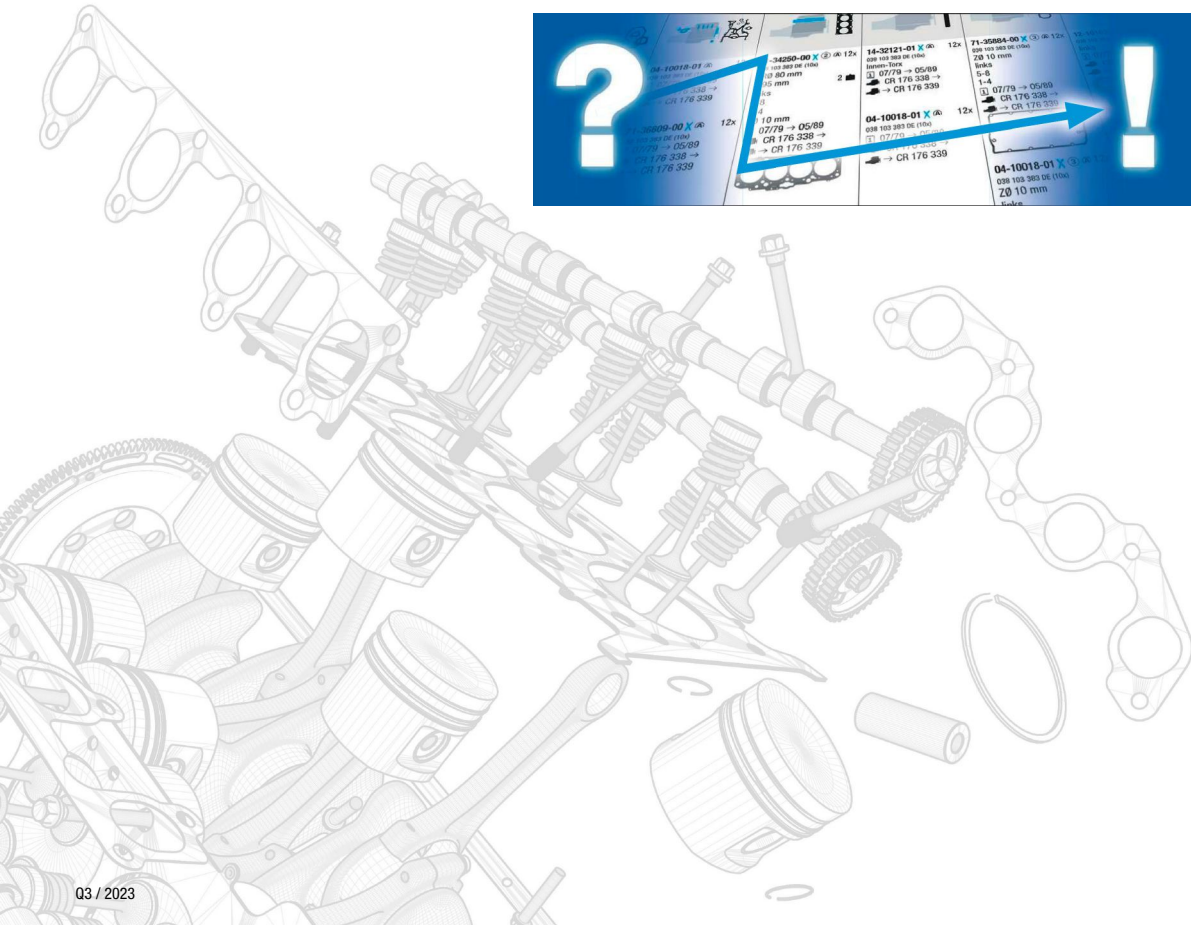

RENAULT

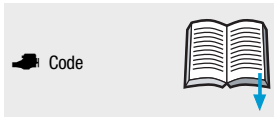

Code

0-9

798-10 14

8140.07.2530 ID 6

8140.07.2585 7

8140.21.235 5

8140.23.2565 8

8140.23.2585 8

8140.27.2530 IDS 6

8140.43.2585 9

8140.43.B.3586 8

8140.43.B.3588 8

8140.43.C.2586 8

8140.43.S.2585 8

8140.43.S.3585 8

8140.43K 8

8140.43N.3585 9

8140.47.2530 IDR 6

8140.47.2585 7

8140.47.2590 7

8140.61.235 5

8140.63.2585 9

8140.67.2585 8

D

DCI 4-B 10

DCI 4-C 10

DCI 6-A 14

DCI 6-W 15

DTI11 27

DTI11-122HH 27

DTI11-122HI 27

DTI11-122HJ 27

DTI13 34

DTI13-122HK 34

DTI13-122HL 34

DTI13-122HM 34

DTI5-122HN 11

DTI5-122HP 11

DTI8-122HQ 17

DTI8-122HR 17

DTI8-122HS 17

DXi 11 28

DXi 12 34

DXi 13 34

DXi 2,5 6



Code

DXi 3 9

DXi 5 11

DXi 5-180 11

DXi 5-220 11

DXi 7 17

DXi 7-270 16

DXi 7-300 16

DXi 7-310 16

DXi 7-340 16

E

EE9-502 35

M

MACK E.TECH A/46 30

MACK E.TECH B/46 30

MACK E.TECH C/46 30

MDS 06.35.40 A 30

MID 06.20.30 18

MIDR 04.02.26 A/4 11

MIDR 04.02.26 A/41 11

MIDR 04.02.26 B/4 11

MIDR 04.02.26 B/41 11

MIDR 06.02.12 D 12

MIDR 06.02.26 15

MIDR 06.02.26 D 15

MIDR 06.02.26 H 15

MIDR 06.02.26 Q 15

MIDR 06.02.26 S 15

MIDR 06.02.26 U 15

MIDR 06.02.26 U/4 16

MIDR 06.02.26 V 16

MIDR 06.02.26 V/4 16

MIDR 06.02.26 V/41 16

MIDR 06.02.26 W 15

MIDR 06.02.26 W/4 16

MIDR 06.02.26 W/41 16

MIDR 06.02.26 X 15

MIDR 06.02.26 Y/41 16

MIDR 06.20.45 19-20

MIDR 06.20.45 A2 20

MIDR 06.20.45 B3 20-21

MIDR 06.20.45 C/4 21

MIDR 06.20.45 D 19-20, 22-23

MIDR 06.20.45 D/41 21, 24



Code

MIDR 06.20.45 D3 22

MIDR 06.20.45 E 20

MIDR 06.20.45 E/41 21, 24

MIDR 06.20.45 E2 20

MIDR 06.20.45 E3 20

MIDR 06.20.45 H 20

MIDR 06.20.45 I41 20

MIDR 06.20.45 L 20

MIDR 06.20.45 M3 20

MIDR 06.20.45 M41 24

MIDR 06.20.45 R41 24

MIDR 06.23.56 A/3 28

MIDR 06.23.56 A/41 28

MIDR 06.23.56 B/41 28

MIDR 06.24.65 A/42 30

MIDR 06.24.65 B/42 30, 34

MIDR 06.24.65 C/42 30

MIDR 06.35.40 31

MIDR 06.35.40 C 29

MIDR 06.35.40 G 31-32

MIDR 06.35.40 H 29, 32

MIDR 06.35.40 J/3 33

MIDR 06.35.40 J1 32

MIDR 06.35.40 L1 33

MIDR 06.35.40 M3 33

MIDR 06.35.40 N/3 33

MIDR 06.35.40 P/41 33

MIDS 06.02.12 B 12-13

MIDS 06.02.12 C 13

MIDS 06.02.12 D/3 14

MIDS 06.20.30 18

MIDS 06.20.30 N 18

MIDS 06.20.30 N1 18-19

MIDS 06.20.30 P 18

MIDS 06.20.45 25

MIDS 06.20.45 B 22, 25-26

MIDS 06.20.45 J 20

MIDS 06.20.45 J3 20

MIDS 06.35.40 D 33

MIHR 06.20.45 A41 26

MIPR 06.20.45 A3 27

MIPS 06.20.45 B 27

Mack-EE9-530 35

Mack-EE9-560 35



Code

Z

ZD3 A 600 10

ZD3 A 604 10

D

dCi 11 B/43 28



dCi 11-270 28

dCi 11C 28

dCi 11E 28

dCi 11G 28

RENAULT

Ltr.   

2,4 8140.21.235 68-71 kW (92-96 PS)



2,4 8140.61.235 53 kW (72 PS)

02-31733-01
77 01 203 210
 566732→
 1051188

02-31830-03
 566731

02-33951-08
 1051189→

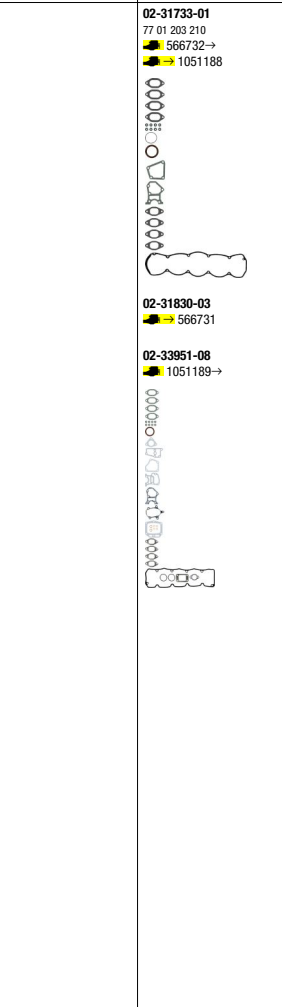

08-31749-04

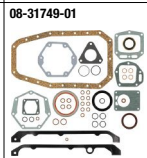

08-31749-01

61-45225-00
1,2 mm



61-31810-00
77 01 038 871
95 Ø
1,9 mm
 12/88



61-33610-00
77 01 038 393
95,2 Ø
1,65 mm
 01/89→

61-33610-10
95,2 Ø
1,7 mm
 01/89→

61-33610-20
95,2 Ø
1,8 mm



14-32096-01
50 01 001 215 (10x)
+50 01 001 216 (12x)

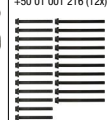

14-32096-01
50 01 001 215 (10x)
+50 01 001 216 (12x)

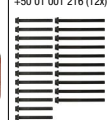

71-31733-00



71-31733-00
 566732→
 1051188



71-31739-10
77 01 031 953
 566731

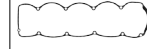

71-33951-10
50 01 846 751
 1051189→



12-34914-05
74 20 459 855 (8x)

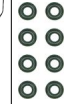

12-34914-05
74 20 459 855 (8x)



70-34914-00
74 20 459 855



71-33621-00  4x
77 00 034 967



71-33654-00  4x
77 01 035 824



71-33957-00  8x



71-33621-00  4x
77 00 034 967



71-33654-00  4x
77 01 035 824



71-33957-00  8x



71-34049-10



71-34049-10



81-33624-10  K→
77 01 035 019
90x115
A SL LD FPM



81-33627-00  N
77 01 035 740
55x70
A SL RD FPM



81-33623-00  K→
50 01 000 786
70x90
A SL RD FPM





81-33624-10  K→
77 01 035 019
90x115
A SL LD FPM













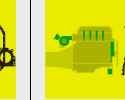
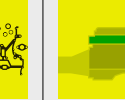
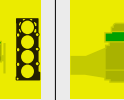

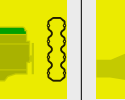
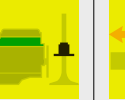
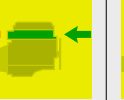

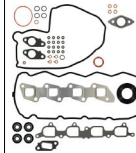



81-33627-00  N
77 01 035 740
55x70
A SL RD FPM













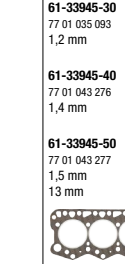
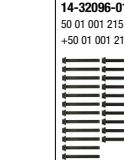
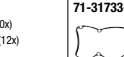
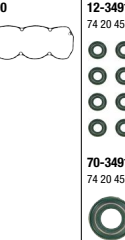
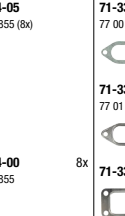
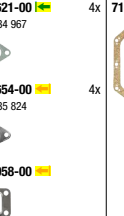
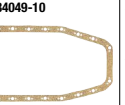



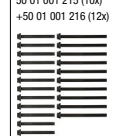





RENAULT



Ltr.  2,5 DXi 2,5  81-110 kW (110-150 PS)  1

											
		<p>02-53694-01 50 01 873 993</p> 		<p>61-53635-00 50 01 869 309 89 Ø 0,9 mm MLS 0</p> <p>61-53635-10 50 01 869 310 89 Ø 0,93 mm MLS 1</p> <p>61-53635-20 50 01 869 311 89 Ø 0,95 mm MLS 2</p> <p>61-53635-30 50 01 869 312 89 Ø 0,98 mm MLS 3</p> <p>61-53635-40 50 01 869 313 89 Ø 1 mm MLS 4</p> <p>61-53635-50 50 01 869 315 89 Ø 1,03 mm MLS 5</p> 		<p>71-53694-00</p> 	<p>12-52772-03</p> 	<p>71-53692-00 </p> <p>50 01 869 631</p>  <p>71-53198-00 </p> <p>50 01 869 633</p> 	<p>70-31414-10</p> 	<p>81-53387-00 </p> <p>50x62 RD</p>  <p>81-41272-00 </p> <p>84x104 A SL LD</p> 	



















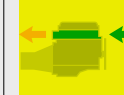





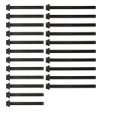



2,5 8140.07.2530 ID 56-85 kW (76-116 PS)
8140.27.2530 IDS
8140.47.2530 IDR

											
	<p>01-31733-09</p> 	<p>02-31733-10 77 01 205 185</p> 		<p>61-33945-30 77 01 035 093 1,2 mm</p> <p>61-33945-40 77 01 043 276 1,4 mm</p> <p>61-33945-50 77 01 043 277 1,5 mm 13 mm 2</p> 	<p>14-32096-01 50 01 001 215 (10x) +50 01 001 216 (12x)</p> 	<p>71-31733-00</p> 	<p>12-34914-05 74 20 459 855 (8x)</p>  <p>70-34914-00 74 20 459 855</p> 	<p>71-33621-00 </p> <p>77 00 034 967</p>  <p>71-33654-00 </p> <p>77 01 035 824</p>  <p>71-33958-00 </p> 	<p>71-34049-10</p> 	<p>81-33623-00 </p> <p>50 01 000 786 70x90 A SL RD FPM</p>  <p>81-33627-00 N</p> <p>77 01 035 740 55x70 A SL RD FPM</p> 	





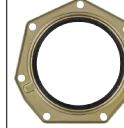









RENAULT

Ltr.   











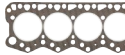
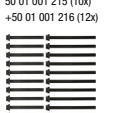

2,5 8140.07.2585 55 kW (75 PS)

										
<p>01-31733-08 </p>	<p>02-31733-10 </p>			<p>61-33945-30 77 01 035 093 1,2 mm</p> <p>61-33945-40 77 01 043 276 1,4 mm</p> <p>61-33945-50 77 01 043 277 1,5 mm 13 mm</p> 	<p>14-32096-01 50 01 001 215 (10x) +50 01 001 216 (12x)</p> 	<p>71-31733-00 </p>	<p>12-34914-05 74 20 459 855 (8x)</p>  <p>70-34914-00 74 20 459 855</p> 	<p>71-33621-00  4x 77 00 034 967</p> <p>71-33654-00  4x 77 01 035 824</p> <p>71-33958-00  8x </p>	<p>71-34049-10 </p>	<p>81-33623-00   50 01 000 786 70x90 A.SL.RD.FPM</p> <p>81-90042-00   50 01 865 996 FPM</p>  <p>81-33627-00 N 77 01 035 740 55x70 A.SL.RD.FPM</p> 

2,5 8140.07.2585 85 kW (116 PS)

<p>01-33951-05 </p>	<p>02-33951-08 </p>			<p>61-33945-30 77 01 035 093 1,2 mm</p> <p>61-33945-40 77 01 043 276 1,4 mm</p> <p>61-33945-50 77 01 043 277 1,5 mm 13 mm</p> 	<p>14-32096-01 50 01 001 215 (10x) +50 01 001 216 (12x)</p> 	<p>71-33951-10 50 01 846 751</p> 	<p>12-34914-05 74 20 459 855 (8x)</p>  <p>70-34914-00 74 20 459 855</p> 	<p>71-33621-00  4x 77 00 034 967</p> <p>71-33654-00  4x 77 01 035 824</p> <p>71-33958-00  8x </p>	<p>71-83048-00 </p>	<p>81-33623-00   50 01 000 786 70x90 A.SL.RD.FPM</p> 
--	--	--	--	---	--	--	--	---	--	--

2,5 8140.47.2590 85 kW (116 PS)

<p>01-33951-05 </p>	<p>02-33951-08 </p>			<p>61-33945-30 77 01 035 093 1,2 mm</p> <p>61-33945-40 77 01 043 276 1,4 mm</p> <p>61-33945-50 77 01 043 277 1,5 mm 13 mm</p> 	<p>14-32096-01 50 01 001 215 (10x) +50 01 001 216 (12x)</p> 	<p>71-33951-10 50 01 846 751</p> 	<p>70-34914-00 74 20 459 855</p> 	<p>71-33621-00  4x 77 00 034 967</p> <p>71-33654-00  4x 77 01 035 824</p> 	<p>71-83048-00 </p>	<p>81-33623-00   50 01 000 786 70x90 A.SL.RD.FPM</p> 
---	---	--	--	---	---	---	---	---	---	---

RENAULT													
Ltr.													
2,5	8140.67.2585	55 kW (75 PS)	<p>01-33951-09</p>	<p>02-33951-09</p>			<p>61-33610-00 77 01 038 393 95,2 Ø 1,65 mm</p> <p>61-33610-10 95,2 Ø 1,7 mm</p> <p>61-33610-20 95,2 Ø 1,8 mm</p>	<p>14-32096-01 50 01 001 215 (10x) +50 01 001 216 (12x)</p>	<p>71-33951-10 50 01 846 751</p>	<p>12-34914-05 74 20 459 855 (8x)</p> <p>70-34914-00 74 20 459 855</p> <p>8x</p>	<p>71-33621-00 </p> <p>77 00 034 967</p> <p>71-33654-00 </p> <p>77 01 035 824</p> <p>4x</p>	<p>71-34049-10</p>	<p>81-10173-00 </p> <p>FPM</p> <p>81-90042-00 </p> <p>50 01 865 996 FPM</p>
2,8	8140.23.2565 8140.23.2585	76-78 kW (103-106 PS)	<p>01-31733-11</p>	<p>02-31733-11</p>			<p>61-33950-00 77 01 044 225 1,3 mm</p> <p>61-33950-10 77 01 044 226 1,4 mm</p> <p>61-33950-20 77 01 044 227 1,5 mm</p>	<p>14-32096-01 50 01 001 215 (10x) +50 01 001 216 (12x)</p>	<p>71-31733-00</p>	<p>12-34914-05 74 20 459 855 (8x)</p> <p>70-34914-00 74 20 459 855</p> <p>8x</p>	<p>71-33621-00 </p> <p>77 00 034 967</p> <p>71-33654-00 </p> <p>77 01 035 824</p> <p>4x</p> <p>71-33963-00 </p> <p>77 01 035 824</p> <p>8x</p>	<p>71-33939-10</p>	<p>81-10173-00 </p> <p>FPM</p> <p>81-90042-00 </p> <p>50 01 865 996 FPM</p>
2,8	8140.43.B.3586 8140.43.B.3588 8140.43.C.2586 8140.43.S.2585 8140.43.S.3585	78-94 kW (106-128 PS)	<p>01-33951-10</p>	<p>02-33951-10 77 01 206 362</p>			<p>61-33950-00 77 01 044 225 1,3 mm</p> <p>61-33950-10 77 01 044 226 1,4 mm</p> <p>61-33950-20 77 01 044 227 1,5 mm</p>	<p>14-32096-01 50 01 001 215 (10x) +50 01 001 216 (12x)</p>	<p>71-33951-10 50 01 846 751</p>	<p>12-34914-05 74 20 459 855 (8x)</p> <p>70-34914-00 74 20 459 855</p> <p>8x</p>	<p>71-33621-00 </p> <p>77 00 034 967</p> <p>71-33654-00 </p> <p>77 01 035 824</p> <p>4x</p>	<p>71-33944-10</p>	<p>81-90042-00 </p> <p>50 01 865 996 FPM</p>
2,8	8140.43K	103-107 kW (140-146 PS)	<p>01-33951-07</p>	<p>02-33951-07</p>			<p>61-33950-00 77 01 044 225 1,3 mm</p> <p>61-33950-10 77 01 044 226 1,4 mm</p> <p>61-33950-20 77 01 044 227 1,5 mm</p>	<p>14-32096-01 50 01 001 215 (10x) +50 01 001 216 (12x)</p>	<p>71-33951-10 50 01 846 751</p>	<p>12-34914-05 74 20 459 855 (8x)</p> <p>70-34914-00 74 20 459 855</p> <p>8x</p>	<p>71-33621-00 </p> <p>77 00 034 967</p> <p>71-33654-00 </p> <p>77 01 035 824</p> <p>4x</p> <p>71-33963-00 </p> <p>77 01 035 824</p> <p>8x</p>	<p>71-34049-10</p>	<p>81-90042-00 </p> <p>50 01 865 996 FPM</p>

RENAULT

Ltr.

2,8 8140.43N.3585 107 kW (146 PS)



2,8 8140.43.2585 90 kW (122 PS)

<p>01-33951-07</p>	<p>02-33951-07</p>			<p>61-33950-00 77 01 044 225 1,3 mm</p> <p>61-33950-10 77 01 044 226 1,4 mm</p> <p>61-33950-20 77 01 044 227 1,5 mm</p>	<p>14-32096-01 50 01 001 215 (10x) +50 01 001 216 (12x)</p>	<p>71-33951-10 50 01 846 751</p>	<p>12-34914-05 74 20 459 855 (8x)</p> <p>70-34914-00 74 20 459 855</p> <p>8x</p>	<p>71-33621-00 4x 77 00 034 967</p> <p>71-33654-00 4x 77 01 035 824</p> <p>71-33963-00 16</p>	<p>71-34049-10</p>	<p>81-90042-00 FPM</p> <p>81-90042-00 FPM</p>
--------------------	--------------------	--	--	---	---	--------------------------------------	--	--	--------------------	---

2,8 8140.63.2585 63-64 kW (86-87 PS)

<p>01-33956-05</p>	<p>02-33956-03</p>			<p>61-33955-00 1,6 mm</p> <p>61-33955-10 1,7 mm</p> <p>61-33955-20 1,8 mm</p>	<p>14-32096-01 50 01 001 215 (10x) +50 01 001 216 (12x)</p>	<p>71-33956-00</p>	<p>12-34914-05 74 20 459 855 (8x)</p> <p>70-34914-00 74 20 459 855</p> <p>8x</p>	<p>71-33621-00 4x 77 00 034 967</p> <p>71-33654-00 4x 77 01 035 824</p>	<p>71-33944-10</p>	<p>81-90042-00 FPM</p> <p>81-90042-00 FPM</p>
--------------------	--------------------	--	--	---	---	--------------------	--	---	--------------------	---

























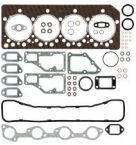

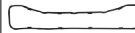









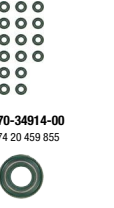





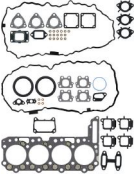

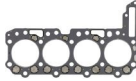







3,0 DXI 3 110 kW (150 PS) MAXITY

03/07

<p>01-53583-02 77 01 058 179</p>	<p>02-53583-02 77 01 475 738</p>		<p>04-10212-01 </p>	<p>61-53530-00 77 01 058 029 97 Ø 0,65 mm MLS </p> <p>61-53530-10 77 01 058 030 97 Ø 0,7 mm MLS </p>	<p>14-32279-01 77 01 058 031 (4x) +77 01 058 032 (14x)</p>	<p>71-53583-00</p>	<p>12-52748-01 77 01 064 021 (16x)</p> <p>70-53957-00</p> <p>16x</p>	<p>71-53586-00 77 01 057 927</p> <p>71-38512-00 77 01 059 057</p>		<p>81-53584-00 FPM</p> <p>81-90044-00 FPM</p>
--------------------------------------	--------------------------------------	--	---------------------	--	--	--------------------	--	---	--	---













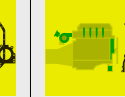

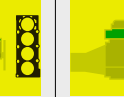
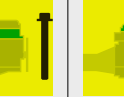
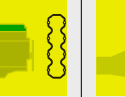

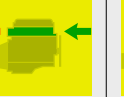

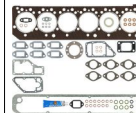
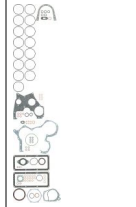

RENAULT					
Ltr.					
3,0	ZD3 A 600	85 kW (115 PS)			
			<p>01-53583-02 77 01 058 179</p>	<p>02-53583-02 77 01 475 738</p>	
			<p>61-53530-00 77 01 058 029 97 Ø 0,65 mm MLS</p> <p>61-53530-10 77 01 058 030 97 Ø 0,7 mm MLS</p>	<p>14-32279-01 77 01 058 031 (4x) +77 01 058 032 (14x)</p>	
				<p>71-53583-00</p>	<p>12-52748-01 77 01 064 021 (16x)</p>
				<p>71-53586-00 </p> <p>77 01 057 927</p>	<p>71-38512-00 </p> <p>77 01 059 057</p>
				<p>70-53957-00 16x</p>	<p>81-53584-00 </p> <p>77 01 058 087 52x66 FPM</p>
				<p>81-90044-00 </p> <p>77 01 058 047</p>	
3,0	ZD3 A 604	115 kW (156 PS)			
			<p>01-53583-02 77 01 058 179</p>	<p>02-53583-02 77 01 475 738</p>	
			<p>04-10193-01 </p>	<p>61-53530-00 77 01 058 029 97 Ø 0,65 mm MLS</p> <p>61-53530-10 77 01 058 030 97 Ø 0,7 mm MLS</p>	
				<p>14-32279-01 77 01 058 031 (4x) +77 01 058 032 (14x)</p>	
				<p>71-53583-00</p>	<p>12-52748-01 77 01 064 021 (16x)</p>
				<p>71-53586-00 </p> <p>77 01 057 927</p>	<p>71-38512-00 </p> <p>77 01 059 057</p>
				<p>70-53957-00 16x</p>	<p>81-53584-00 </p> <p>77 01 058 087 52x66 FPM</p>
				<p>81-90044-00 </p> <p>77 01 058 047</p>	
4,1	DCI 4-B	110-112 kW (150-152 PS)	MIDLUM	01/00	
			<p>02-31125-02 50 01 856 179</p>	<p>08-37729-01 50 01 856 180 08/01</p>	
			<p>08-37729-02 50 01 858 745 09/01 →</p>	<p>61-31125-00 50 10 450 664 112 Ø 1,5 mm</p>	
				<p>71-37686-00 50 10 622 085 04/03</p>	<p>12-37794-02 50 00 676 155 (8x)</p>
				<p>71-37687-00 </p> <p>50 10 450 519 50 10 553 703 05/03 →</p>	<p>71-37827-00 </p> <p>50 00 684 638</p>
				<p>71-37874-00 </p> <p>50 10 450 519 04/03</p>	<p>71-37876-00 </p> <p>50 10 553 380 05/03 →</p>
				<p>70-37794-00 8x</p>	<p>71-38484-00 50 10 450 945 09/01 →</p>
				<p>81-25013-30 </p> <p>50 10 339 722 80x100 B SL RD PTFE</p>	<p>81-33801-00 </p> <p>50 10 339 723 110x130 B SL LD PTFE ACM</p>
4,1	DCI 4-B DCI 4-C	112-128 kW (152-174 PS)	MIDLUM	10/01	
			<p>02-31125-02 50 01 856 179</p>	<p>08-37729-02 50 01 858 745</p>	
			<p>61-31125-00 50 10 450 664 112 Ø 1,5 mm</p>	<p>71-37686-00 50 10 622 085 04/03</p>	
				<p>71-37687-00 </p> <p>50 10 450 519 50 10 553 703 05/03 →</p>	<p>12-37794-02 50 00 676 155 (8x)</p>
				<p>71-37827-00 </p> <p>50 00 684 638</p>	<p>71-37874-00 </p> <p>50 10 450 519 04/03</p>
				<p>71-37876-00 </p> <p>50 10 553 380 05/03 →</p>	<p>71-38484-00 50 10 450 945</p>
				<p>70-37794-00 8x</p>	<p>81-25013-30 </p> <p>50 10 339 722 80x100 B SL RD PTFE</p>
				<p>81-33801-00 </p> <p>50 10 339 723 110x130 B SL LD PTFE ACM</p>	

RENAULT











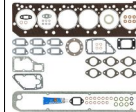

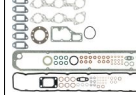

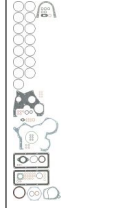

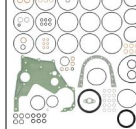



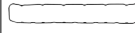









Ltr.														
4,1	MIDR 04.02.26 A/4 MIDR 04.02.26 A/41 MIDR 04.02.26 B/4 MIDR 04.02.26 B/41	100-112 kW (136-152 PS)	MIDLINER MIDLUM	05/96	 02-31125-01 50 01 835 770	 08-33801-01 50 01 835 771		 61-31125-00 50 10 450 664 112 Ø 1,5 mm		 71-37686-00 50 10 622 085	 12-37794-02 50 00 676 155 (8x)	 71-37827-00  50 00 684 638	 70-31414-10	 81-25013-30  50 10 339 722 80x100 B SL RD PTFE
4,8	DXI 5 DXI 5-180 DXI 5-220	118-161 kW (160-220 PS)	D-Serie MIDLUM	05/06				 61-36835-00 74 20 859 732 1,15 mm  61-36835-10 74 20 859 733 1,25 mm 		 71-37698-00 74 20 795 233	 12-34914-06 74 20 459 855 (16x)	 71-37842-00  74 20 794 356	 70-31414-10	 81-35999-00  74 21 486 081 81x104 FPM
5,1	DT15-122HN DT15-122HP	154-177 kW (209-241 PS)	D-Serie	01/13	 02-10147-01 74 21 914 900	 08-11736-01 74 21 914 897		 61-10147-00 74 22 231 933 114,5 Ø 1,15 mm MLS	 14-11702-01 74 00 993 799 (14x) +74 00 993 802 (4x) +74 00 984 757 (1x) +74 00 975 192 (1x)	 71-11781-00  74 21 717 476	 12-37804-02 74 20 864 662 (16x)	 71-11685-01  74 21 698 165	 71-11736-00 74 21 537 231	 81-10466-00  74 21 481 950
										 71-11782-00  74 21 717 615	 70-37804-00 74 20 864 662	 11-11685-01  74 21 914 906	 71-11689-00  74 21 742 293	 81-10463-00  74 21 230 631

RENAULT

Ltr.  5,5 MIDR 06.02.12 D 113-135 kW (154-183 PS) G-Serie MIDLINER  10/82-03/93 

											
	<p>02-29225-03 50 01 826 449</p> 	<p>08-37733-01 50 01 826 450</p> 		<p>61-29225-00 50 10 450 731 112 Ø 1,5 mm</p> 		<p>71-37676-00 50 00 794 488</p> 	<p>12-37797-01 08 52 959 800 (6x)</p>  <p>70-37797-00 08 52 959 800</p> 	<p>71-37869-00  6x 50 00 684 470</p> 	<p>71-37731-00 00 36 813 035</p> 	<p>81-37916-00  50 00 133 683 60x75 A SL RD FPM</p>  <p>81-37733-00  50 00 680 251 110x130 A SL LD FPM</p> 	

5,5 MIDR 06.02.12 D 127-135 kW (173-183 PS) MIDLINER 10/82-09/93

	<p>02-29225-03 50 01 826 449  05/90</p>  <p>02-29225-02 50 01 830 817  06/90→</p> 	<p>08-37733-01 50 01 826 450  12/90</p>  <p>08-33801-02 50 01 826 453  01/91→</p> 		<p>61-29225-00 50 10 450 731 112 Ø 1,5 mm</p> 		<p>71-37676-00 50 00 794 488  05/90</p>  <p>71-37688-00 50 10 622 086  06/90→</p> 	<p>12-37797-01 08 52 959 800 (6x)</p>  <p>70-37797-00 08 52 959 800</p> 	<p>71-37828-00  2x 50 00 676 810  06/90→</p>  <p>71-37869-00  6x 50 00 684 470</p> 	<p>71-37731-00 00 36 813 035</p> 	<p>81-37916-00  50 00 133 683 60x75 A SL RD FPM  05/90</p>  <p>81-25013-30  50 10 339 722 80x100 B SL RD PTFE  06/90→</p>  <p>81-37733-00  50 00 680 251 110x130 A SL LD FPM  12/90</p>  <p>81-33801-00  50 10 339 723 110x130 B SL LD PTFE ACM  01/91→</p> 
--	--	--	--	--	--	--	--	--	---	--

RENAULT

Ltr.   

5,5 MIDS 06.02.12 B 117 kW (159 PS) MIDLINER 05/89-09/93

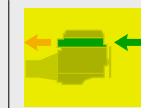

5,5 MIDS 06.02.12 C 103 kW (140 PS) MIDLINER 04/89-09/93

02-29225-03
50 01 826 449
1 → 05/90



02-29225-02
50 01 830 817
1 → 06/90 →



08-37733-01
50 01 826 450
1 → 05/90



08-33801-02
50 01 826 453
1 → 06/90 →



61-29225-00
50 10 450 731
112 Ø
1,5 mm



71-37676-00
50 00 794 488
1 → 05/90



71-37688-00
50 10 622 086
1 → 06/90 →



12-37797-01
08 52 959 800 (6x)









70-37797-00
08 52 959 800



71-37828-00  2x
50 00 676 810





71-37869-00  6x
50 00 684 470





71-37731-00
00 36 813 035





81-37916-00  
50 00 133 683
60x75
A SL RD FPM
1 → 05/90





81-25013-30  
50 10 339 722
80x100
B SL RD PTFE
1 → 06/90 →



81-37733-00  
50 00 680 251
110x130
A SL LD FPM
1 → 05/90



81-33801-00  
50 10 339 723
110x130
B SL LD PTFE ACM
1 → 06/90 →



02-29225-04
50 01 830 818
1 → 02/90



02-29225-02
50 01 830 817
1 → 03/90 →



08-33801-02
50 01 826 453



61-29225-00
50 10 450 731
112 Ø
1,5 mm



71-37676-00
50 00 794 488
1 → 02/90



71-37688-00
50 10 622 086
1 → 03/90 →



12-37797-01
08 52 959 800 (6x)









70-37797-00
08 52 959 800



71-37828-00  2x
50 00 676 810





71-37869-00  6x
50 00 684 470





71-37731-00
00 36 813 035















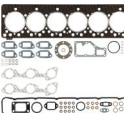





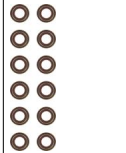















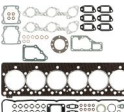







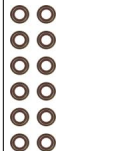















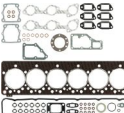







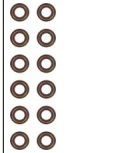









81-25013-30  
50 10 339 722
80x100
B SL RD PTFE



81-33801-00  
50 10 339 723
110x130
B SL LD PTFE ACM



RENAULT

























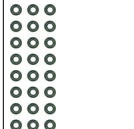













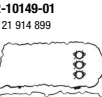

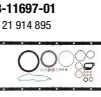

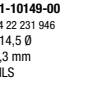

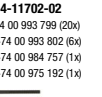
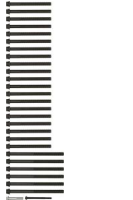
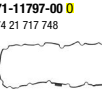





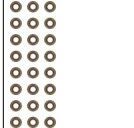





<p>Ltr.  5,5 MIDS 06.02.12 D/3 110 kW (150 PS) MIDLINER 01/94-05/96 </p>		<p>02-28915-02 50 01 854 364</p> 	<p>08-33801-02 50 01 826 453</p> 		<p>61-28915-00 50 10 450 423 112 Ø 1,5 mm</p> 		<p>71-37688-00 50 10 622 086</p> 	<p>12-37794-03 50 00 676 155 (12x)</p> 	<p>71-37828-00  2x 50 00 676 810</p>  <p>71-37869-00  6x 50 00 684 470</p> 	<p>71-37731-00 00 36 813 035</p> 	<p>81-25013-30   50 10 339 722 80x100 B SL RD PTFE</p>  <p>81-33801-00   50 10 339 723 110x130 B SL LD PTFE ACM</p> 
<p>5,5 798-10 113 kW (154 PS) MIDLINER 05/83-07/86</p>					<p>61-29225-00 50 10 450 731 112 Ø 1,5 mm</p> 				<p>71-37828-00  2x 50 00 676 810</p>  <p>71-37869-00  6x 50 00 684 470</p> 		
<p>6,2 DCI 6-A 195 kW (265 PS) MIDLUM 10/01</p>		<p>02-28915-03 50 01 856 181</p> 	<p>08-37738-01 50 01 858 729</p> 		<p>61-28915-00 50 10 450 423 112 Ø 1,5 mm</p> 		<p>71-37688-00 50 10 622 086  04/03</p>  <p>71-39579-00   50 10 553 654  05/03→</p> 	<p>12-37794-03 50 00 676 155 (12x)</p> 	<p>71-37828-00  2x 50 00 676 810</p>  <p>71-37874-00  6x 50 10 450 519  04/03</p>  <p>71-37883-00   50 10 553 379  05/03→</p> 	<p>71-37738-00 50 10 450 956</p> 	<p>81-25013-30   50 10 339 722 80x100 B SL RD PTFE</p>  <p>81-33801-00   50 10 339 723 110x130 B SL LD PTFE ACM</p> 
<p>6,2 DCI 6-A 195 kW (265 PS) PREMIUM DISTRIBUTION 08/00</p>		<p>02-28915-03 50 01 856 181</p> 	<p>08-37738-01 50 01 858 729</p> 		<p>61-28915-00 50 10 450 423 112 Ø 1,5 mm</p> 		<p>71-37688-00 50 10 622 086  04/03</p>  <p>71-39579-00   50 10 553 654  05/03→</p> 	<p>12-37794-03 50 00 676 155 (12x)</p> 	<p>71-37828-00  2x 50 00 676 810</p>  <p>71-37874-00  6x 50 10 450 519  04/03</p>  <p>71-37883-00   50 10 553 379  05/03→</p> 	<p>71-37739-00 50 10 450 773  09/01</p>  <p>71-37738-00 50 10 450 956  10/01→</p> 	<p>81-25013-30   50 10 339 722 80x100 B SL RD PTFE</p>  <p>81-33801-00   50 10 339 723 110x130 B SL LD PTFE ACM</p> 

RENAULT

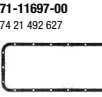
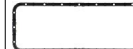
RENAULT															
6,2	DCI 6-W	154-158 kW (209-215 PS)	MIDLUM PREMIUM DISTRIBUTION	04/96		02-28915-02 50 01 854 364 	08-33801-02 50 01 826 453 		61-28915-00 50 10 450 423 112 Ø 1,5 mm 		71-37688-00 50 10 622 086 1 → 04/03 71-39579-00 ✕ 50 10 553 654 1 → 05/03 → 	12-37794-01 50 00 676 155 (6x) 70-37794-00 50 00 676 155 	71-37828-00 2x 50 00 676 810 71-37869-00 6x 50 00 684 470 	70-31414-10 	81-25013-30 50 10 339 722 80x100 B SL RD PTFE 81-33801-00 50 10 339 723 110x130 B SL LD PTFE ACM
6,2	MIDR 06.02.26 MIDR 06.02.26 D MIDR 06.02.26 H MIDR 06.02.26 S MIDR 06.02.26 X	144-166 kW (196-226 PS)	G-Serie MIDLINER	09/87-10/96		02-28915-01 50 01 826 451 1 → 02/90 02-28915-02 50 01 854 364 1 → 03/90 → 	08-33801-02 50 01 826 453 		61-28915-00 50 10 450 423 112 Ø 1,5 mm 		71-37676-00 50 00 794 488 1 → 02/90 71-37688-00 50 10 622 086 1 → 03/90 → 	12-37794-01 50 00 676 155 (6x) 70-37794-00 50 00 676 155 	71-37828-00 2x 50 00 676 810 71-37869-00 6x 50 00 684 470 	71-37731-00 00 36 813 035 	81-25013-30 50 10 339 722 80x100 B SL RD PTFE 81-33801-00 50 10 339 723 110x130 B SL LD PTFE ACM
6,2	MIDR 06.02.26 D MIDR 06.02.26 H MIDR 06.02.26 Q MIDR 06.02.26 U MIDR 06.02.26 V MIDR 06.02.26 W MIDR 06.02.26 X	110-166 kW (150-226 PS)	CLR C-Serie G-Serie MANAGER MIDLINER	05/90-01/00		02-28915-02 50 01 854 364 	08-33801-02 50 01 826 453 		61-28915-00 50 10 450 423 112 Ø 1,5 mm 		71-37688-00 50 10 622 086 	12-37794-01 50 00 676 155 (6x) 70-37794-00 50 00 676 155 	71-37828-00 2x 50 00 676 810 71-37869-00 6x 50 00 684 470 	71-37731-00 00 36 813 035 	81-25013-30 50 10 339 722 80x100 B SL RD PTFE 81-33801-00 50 10 339 723 110x130 B SL LD PTFE ACM

RENAULT														
Ltr.														
6,2	MIDR 06.02.26 U/4 MIDR 06.02.26 V/4 MIDR 06.02.26 Y/41	110-184 kW (150-250 PS)	MIDLINER MIDLUM PREMIUM DISTRIBUTION	11/92										
					02-28915-02 50 01 854 364 	08-33801-02 50 01 826 453 		61-28915-00 50 10 450 423 112 Ø 1,5 mm 		71-37688-00 50 10 622 086 	12-37794-03 50 00 676 155 (12x) 70-37794-00 50 00 676 155 12x	71-37828-00 2x 50 00 676 810 71-37869-00 6x 50 00 684 470 	70-31414-10 81-25013-30 K 50 10 339 722 80x100 B SL RD PTFE 81-33801-00 K 50 10 339 723 110x130 B SL LD PTFE ACM 	
6,2	MIDR 06.02.26 V/41	132 kW (180 PS)	MIDLINER	05/96-01/00	02-28915-02 50 01 854 364 	08-33801-02 50 01 826 453 		61-28915-00 50 10 450 423 112 Ø 1,5 mm 		71-37688-00 50 10 622 086 	12-37794-01 50 00 676 155 (6x) 70-37794-00 50 00 676 155 12x 70-37794-00 50 00 676 155 6x	71-37828-00 2x 50 00 676 810 71-37869-00 6x 50 00 684 470 	70-31414-10 81-25013-30 K 50 10 339 722 80x100 B SL RD PTFE 81-33801-00 K 50 10 339 723 110x130 B SL LD PTFE ACM 	
6,2	MIDR 06.02.26 W/4 MIDR 06.02.26 W/41	151-158 kW (205-215 PS)	MIDLINER MIDLUM PREMIUM DISTRIBUTION	05/92	02-28915-02 50 01 854 364 	08-33801-02 50 01 826 453 		61-28915-00 50 10 450 423 112 Ø 1,5 mm 		71-37688-00 50 10 622 086 	12-37794-01 50 00 676 155 (6x) 70-37794-00 50 00 676 155 6x	71-37828-00 2x 50 00 676 810 71-37869-00 6x 50 00 684 470 	70-31414-10 81-25013-30 K 50 10 339 722 80x100 B SL RD PTFE 81-33801-00 K 50 10 339 723 110x130 B SL LD PTFE ACM 	
7,1	DXi 7-270 DXi 7-300 DXi 7-310 DXi 7-340	194-250 kW (264-340 PS)	D-Serie	07/13	02-36840-01 74 21 366 087 			61-36840-00 74 20 980 442 109,5 Ø 1,15 mm 1 61-36840-10 X 74 20 996 260 109,5 Ø 1,25 mm 2 		71-39468-00 74 20 788 793 	12-34914-03 74 20 459 855 (24x) 70-34914-00 74 20 459 855 24x	71-37842-00 6x 74 20 794 356 71-36731-00 3x 74 20 911 633 	70-31414-10 81-35999-00 K 74 21 486 081 81x104 FPM 81-10424-00 K 74 21 486 084 130x150 A SL LD FPM 	

RENAULT

<p>Ltr.  7,2 DXi 7</p> <p>177-247 kW (240-340 PS)</p> <p>MIDLUM PREMIUM 2 DISTRIBUTION PREMIUM 2 LANDER</p> <p>10/05</p>		 <p>02-36840-01 74 21 366 087</p> 			 <p>61-36840-00 74 20 980 442 109,5 Ø 1,15 mm </p> <p>61-36840-10  74 20 996 260 109,5 Ø 1,25 mm </p> 		 <p>71-39468-00 74 20 788 793</p> 	 <p>12-34914-03 74 20 459 855 (24x)</p>  <p>70-34914-00 74 20 459 855</p> 	 <p>71-37842-00  6x 74 20 794 356</p>  <p>71-36731-00  3x 74 20 911 633</p> 	 <p>70-31414-10</p> 	 <p>81-35899-00  74 21 486 081 81x104 FPM</p>  <p>81-10424-00  74 21 486 084 130x150 A SL LD FPM</p> 
<p>7,7 DT18-122HQ DT18-122HR DT18-122HS</p> <p>184-235 kW (250-320 PS)</p> <p>C-Serie D ACCESS D-Serie</p> <p>01/13</p>		 <p>02-10149-01 74 21 914 899</p> 	 <p>08-11697-01 74 21 914 895</p> 		 <p>61-10149-00 74 22 231 946 114,5 Ø 1,3 mm MLS</p> 	 <p>14-11702-02 74 00 993 799 (20x) +74 00 993 802 (6x) +74 00 984 757 (1x) +74 00 975 192 (1x)</p> 	 <p>71-11797-00  74 21 717 748</p>  <p>71-11798-00  74 21 717 753</p> 	 <p>12-37804-01 74 20 864 662 (24x)</p>  <p>70-37804-00 74 20 864 662</p> 	 <p>71-11685-00  6x 74 21 698 165</p>  <p>11-11685-02   74 21 914 905</p>  <p>71-11689-00  6x 74 21 742 293</p> 	 <p>71-11697-00 74 21 492 627</p> 	 <p>81-10466-00  74 21 481 950</p>  <p>81-10463-00  74 21 230 631</p> 

RENAULT



Ltr. 8,8 MID 06.20.30 104-177 kW (141-241 PS) C-Serie G-Serie TB 06/80

8,8	02-31115-02 50 01 825 565	08-37732-01 50 01 826 448 1 → 10/85	15-73295-01 6x	61-31115-00 50 10 295 726 128 Ø 1,25 mm		71-31116-00 50 00 694 271	12-31112-02 50 10 295 494 (6x)	71-31113-00 6x 00 00 771 193 1 → 05/88	71-37829-00 2x 50 00 694 362 06/88 →	71-31114-00 6x 00 00 157 841	71-37732-00 50 10 240 658	81-25013-30 K↔ 50 10 339 722 80x100 B SL RD PTFE 1 → 10/85
	03-31116-01 00 00 323 761	08-37732-02 50 01 826 446 11/85 → 1 → 05/88					70-31112-00 50 10 295 494					81-37914-00 K↔ 50 10 359 806 90x110 A SL RD PTFE 11/85 →
		08-37732-03 50 01 826 447 06/88 →										81-37933-00 K↔ 50 10 359 807 150x172 A SL LD PTFE

8,8 MIDS 06.20.30 169-177 kW (230-241 PS) MANAGER 09/91-03/93

8,8	02-31115-02 50 01 825 565	08-37732-03 50 01 826 447	15-73295-01 6x	61-31115-00 50 10 295 726 128 Ø 1,25 mm		71-31116-00 50 00 694 271	12-31112-02 50 10 295 494 (6x)	71-37829-00 2x 50 00 694 362	71-31114-00 6x 00 00 157 841		71-37732-00 50 10 240 658	81-37914-00 K↔ 50 10 359 806 90x110 A SL RD PTFE
	03-31116-01 00 00 323 761						70-31112-00 50 10 295 494					81-37933-00 K↔ 50 10 359 807 150x172 A SL LD PTFE

RENAULT

Ltr.   

8,8 MIDS 06.20.30 N1 162 kW (220 PS) CLR 05/86-05/91

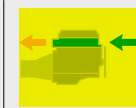

02-31115-02 50 01 825 565

03-31116-01 00 00 323 761

08-37732-02 50 01 826 446
1 → 05/88

08-37732-03 50 01 826 447
1 06/88 →

15-73295-01 6x

61-31115-00 6x
50 10 295 726
128 Ø
1,25 mm

71-31116-00 6x
50 00 694 271

12-31112-02 6x
50 10 295 494 (6x)

71-31113-00 6x
00 00 771 193
1 → 05/88

71-37829-00 2x
50 00 694 362
06/88 →

71-31114-00 6x
00 00 157 841

71-37732-00 6x
50 10 240 658

81-37914-00 K↔ 6x
50 10 359 806
90x110
A SL RD PTFE

81-37933-00 K↔ 6x
50 10 359 807
150x172
A SL LD PTFE

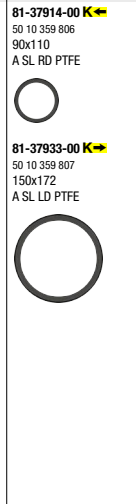
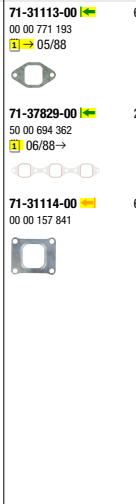
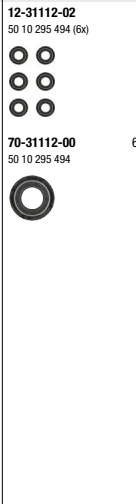
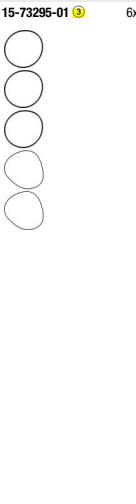

9,8 MIDR 06.20.45 214-222 kW (291-302 PS) FR1 01/83
MIDR 06.20.45 D G-Serie

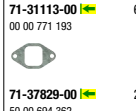
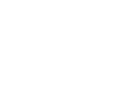
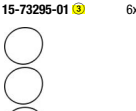

02-31116-02 50 00 793 734

03-31116-01 00 00 323 761

08-37732-02 50 01 826 446
1 → 05/88

08-37732-03 50 01 826 447
1 06/88 →

15-73295-01 6x

61-31115-00 6x
50 10 295 726
128 Ø
1,25 mm

71-31116-00 6x
50 00 694 271

70-25824-20 6x
00 24 472 534

71-31113-00 6x
00 00 771 193

71-37829-00 2x
50 00 694 362

71-31114-00 6x
00 00 157 841



71-37732-00 6x
50 10 240 658

81-37914-00 K↔ 6x
50 10 359 806
90x110
A SL RD PTFE

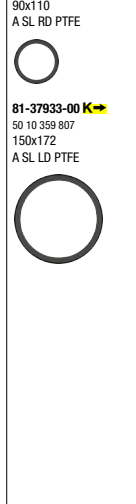
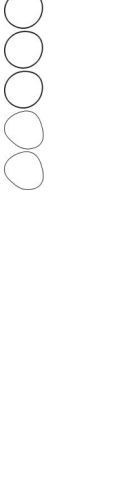
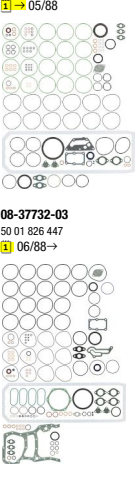
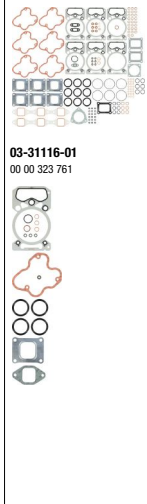











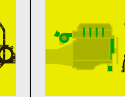

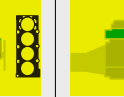
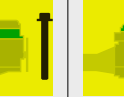
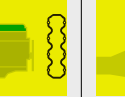

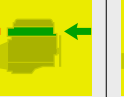

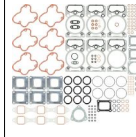



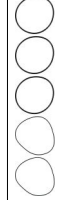
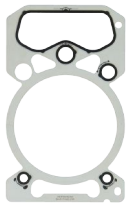
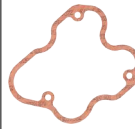

81-37933-00 K↔ 6x
50 10 359 807
150x172
A SL LD PTFE



RENAULT











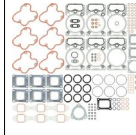

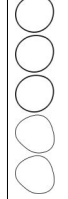
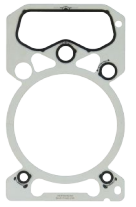
Ltr.   

9,8 MIDR 06.20.45 214-222 kW (291-302 PS) G-Serie 11/85-12/89

											
	<p>02-31116-02 50 00 793 734</p>  <p>03-31116-01 00 00 323 761</p> <p>6x</p>	<p>08-37732-02 50 01 826 446 1 → 05/88</p>  <p>08-37732-03 50 01 826 447 1 06/88 →</p> 	<p>15-73295-01 </p> <p>6x</p> 	<p>61-31115-00 6x</p> <p>50 10 295 726 128 Ø 1,25 mm</p> 		<p>71-31116-00 6x</p> <p>50 00 694 271</p> 	<p>70-25824-20 6x</p> <p>00 24 472 534</p> 	<p>71-31113-00  6x</p> <p>00 00 771 193</p>  <p>71-37829-00  2x</p> <p>50 00 694 362</p>  <p>71-31114-00 6x</p> <p>00 00 157 841</p> 	<p>71-37732-00 6x</p> <p>50 10 240 658</p> 	<p>81-37914-00 </p> <p>50 10 359 806 90x110 A SL RD PTFE</p>  <p>81-37933-00 </p> <p>50 10 359 807 150x172 A SL LD PTFE</p> 	











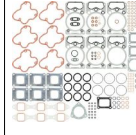

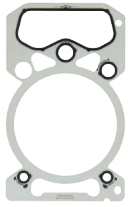
9,8 MIDR 06.20.45 A2 161-250 kW (219-340 PS) AGORA C-Serie
MIDR 06.20.45 E FR1
MIDR 06.20.45 E2 G-Serie
MIDR 06.20.45 E3 MAJOR
MIDR 06.20.45 H MANAGER
MIDR 06.20.45 I41 MAXTER
MIDR 06.20.45 L R-Serie
MIDR 06.20.45 M3
MIDS 06.20.45 J
MIDS 06.20.45 J3

01/83



	<p>02-31116-02 50 00 793 734</p> 	<p>08-37732-03 50 01 826 447</p> 	<p>15-73295-01 </p> <p>6x</p> 	<p>61-31115-00 6x</p> <p>50 10 295 726 128 Ø 1,25 mm</p> 		<p>71-31116-00 6x</p> <p>50 00 694 271</p> 	<p>70-25824-20 6x</p> <p>00 24 472 534</p> 	<p>71-37829-00  2x</p> <p>50 00 694 362</p>  <p>71-31114-00 6x</p> <p>00 00 157 841</p> 	<p>71-37732-00 6x</p> <p>50 10 240 658</p> 	<p>81-37914-00 </p> <p>50 10 359 806 90x110 A SL RD PTFE</p>  <p>81-37933-00 </p> <p>50 10 359 807 150x172 A SL LD PTFE</p> 
--	---	--	---	---	--	---	---	---	---	---

9,8 MIDR 06.20.45 B3 195 kW (265 PS) MANAGER MAXTER

11/92-10/96

	<p>02-31116-02 50 00 793 734</p> 	<p>08-37732-03 50 01 826 447</p> 		<p>61-31115-00 6x</p> <p>50 10 295 726 128 Ø 1,25 mm</p> 		<p>71-31116-00 6x</p> <p>50 00 694 271</p> 	<p>70-25824-20 6x</p> <p>00 24 472 534</p> 	<p>71-31113-00  6x</p> <p>00 00 771 193</p>  <p>71-37213-00 6x</p> <p>50 10 295 218</p> 	<p>71-37732-00 6x</p> <p>50 10 240 658</p> 	<p>81-37914-00 </p> <p>50 10 359 806 90x110 A SL RD PTFE</p>  <p>81-37933-00 </p> <p>50 10 359 807 150x172 A SL LD PTFE</p> 
--	---	--	--	---	--	---	---	---	---	--

RENAULT

Ltr.   

9,8 MIDR 06.20.45 B3 195-202 KW (265-275 PS) MANAGER 09/91-10/96

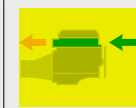

02-31116-02
50 00 793 734



03-31116-01
00 00 323 761

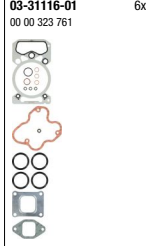

08-37732-03
50 01 826 447



61-31115-00 6x
50 10 295 726
128 Ø
1,25 mm



71-31116-00 6x
50 00 694 271



70-25824-20 6x
00 24 472 534



71-31113-00 6x
00 00 771 193



71-37829-00 2x
50 00 694 362





71-37213-00 6x
50 10 295 218





71-37732-00
50 10 240 658



81-37914-00 
50 10 359 806
90x110
A SL RD PTFE



81-37933-00 
50 10 359 807
150x172
A SL LD PTFE



9,8 MIDR 06.20.45 C/4 188-249 KW (256-339 PS) KERAX 02/96
MIDR 06.20.45 D/41 MAXTER
MIDR 06.20.45 E/41 PREMIUM DISTRIBUTION
PREMIUM ROUTE

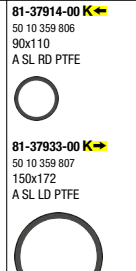
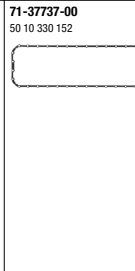
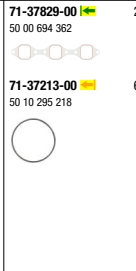
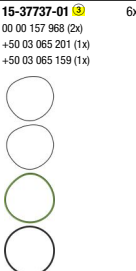

02-31115-01
50 01 834 578

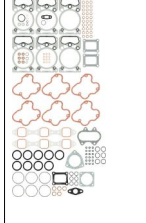

08-37737-01
50 01 834 579

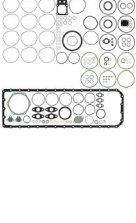

15-37737-01  6x
00 00 157 968 (2x)
+50 03 065 201 (1x)
+50 03 065 159 (1x)

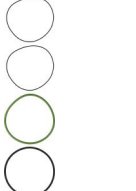

61-31115-00 6x
50 10 295 726
128 Ø
1,25 mm



71-31116-00 6x
50 00 694 271



71-37691-00    6x
50 10 330 375





12-31112-02
50 10 295 494 (6x)



70-31112-00 6x
50 10 295 494



71-37829-00  2x
50 00 694 362





71-37213-00 6x
50 10 295 218





71-37737-00
50 10 330 152



81-37914-00 
50 10 359 806
90x110
A SL RD PTFE





81-37933-00 
50 10 359 807
150x172
A SL LD PTFE













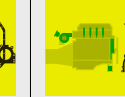

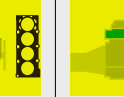
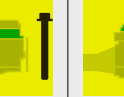
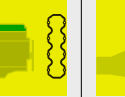

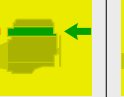



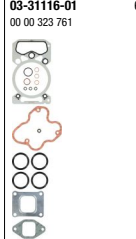



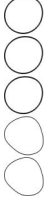

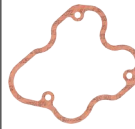



RENAULT













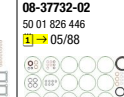
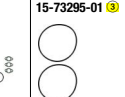

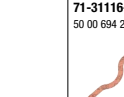
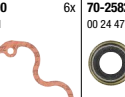
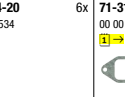
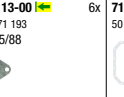



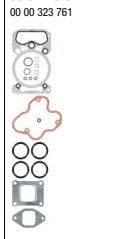



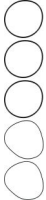



RENAULT													
Ltr.													
9,8 MIDR 06.20.45 D MIDR 06.20.45 D3 MIDS 06.20.45 B	195-222 kW (265-302 PS)	C-Serie FR1 G-Serie MANAGER MAXTER	10/82										
				<p>02-31116-02 50 00 793 734</p> <p>03-31116-01 00 00 323 761</p> <p>6x</p>	<p>08-37732-03 50 01 826 447</p>	<p>15-73295-01 </p> <p>6x</p>	<p>61-31115-00 6x 50 10 295 726 128 Ø 1,25 mm</p>		<p>71-31116-00 6x 50 00 694 271</p>	<p>70-25824-20 6x 00 24 472 534</p>	<p>71-31113-00 </p> <p>00 00 771 193</p> <p>71-37829-00 </p> <p>50 00 694 362</p> <p>2x</p> <p>71-31114-00 </p> <p>00 00 157 841</p> <p>6x</p>	<p>71-37732-00 50 10 240 658</p>	<p>81-37914-00 </p> <p>50 10 359 806 90x110 A SL RD PTFE</p> <p>81-37933-00 </p> <p>50 10 359 807 150x172 A SL LD PTFE</p>
9,8 MIDR 06.20.45 D MIDR 06.20.45 D3 MIDS 06.20.45 B	202-222 kW (275-302 PS)	CCH C-Serie G-Serie MANAGER MAXTER	01/90-10/96										
				<p>02-31116-02 50 00 793 734</p> <p>03-31116-01 00 00 323 761</p> <p>6x</p>	<p>08-37732-03 50 01 826 447</p>	<p>15-73295-01 </p> <p>6x</p>	<p>61-31115-00 6x 50 10 295 726 128 Ø 1,25 mm</p>		<p>71-31116-00 6x 50 00 694 271</p>	<p>70-25824-20 6x 00 24 472 534</p>	<p>71-37829-00 </p> <p>50 00 694 362</p> <p>2x</p> <p>71-31114-00 </p> <p>00 00 157 841</p> <p>6x</p>	<p>71-37732-00 50 10 240 658</p>	<p>81-37914-00 </p> <p>50 10 359 806 90x110 A SL RD PTFE</p> <p>81-37933-00 </p> <p>50 10 359 807 150x172 A SL LD PTFE</p>

RENAULT

Ltr.  9,8 MIDR 06.20.45 D  214-222 kW (291-302 PS) C-Serie  10/82-10/98

											
	<p>02-31116-02 50 00 793 734</p>  <p>03-31116-01 00 00 323 761</p> 	<p>08-37732-01 50 01 826 448 11 → 10/85</p>  <p>08-37732-02 50 01 826 446 11/85 → 11 → 05/88</p>  <p>08-37732-03 50 01 826 447 06/88 →</p> 	<p>15-73295-01  6x</p> 	<p>61-31115-00 6x</p> <p>50 10 295 726 128 Ø 1,25 mm</p> 		<p>71-31116-00 6x</p> <p>50 00 694 271</p> 	<p>70-25824-20 6x</p> <p>00 24 472 534</p> 	<p>71-31113-00  6x</p> <p>00 00 771 193 11 → 05/88</p>  <p>71-37829-00  2x</p> <p>50 00 694 362 06/88 →</p>  <p>71-31114-00 6x</p> <p>00 00 157 841</p> 	<p>71-37732-00</p> <p>50 10 240 658</p> 	<p>81-37914-00  K↔</p> <p>50 10 359 806 90x110 A SL RD PTFE</p>  <p>81-37933-00  K↔</p> <p>50 10 359 807 150x172 A SL LD PTFE</p> 	

9,8 MIDR 06.20.45 D 214-222 kW (291-302 PS) C-Serie 05/86-10/98

											
	<p>02-31116-02 50 00 793 734</p>  <p>03-31116-01 00 00 323 761</p> 	<p>08-37732-02 50 01 826 446 11 → 05/88</p>  <p>08-37732-03 50 01 826 447 06/88 →</p> 	<p>15-73295-01  6x</p> 	<p>61-31115-00 6x</p> <p>50 10 295 726 128 Ø 1,25 mm</p> 		<p>71-31116-00 6x</p> <p>50 00 694 271</p> 	<p>70-25824-20 6x</p> <p>00 24 472 534</p> 	<p>71-31113-00  6x</p> <p>00 00 771 193 11 → 05/88</p>  <p>71-37829-00  2x</p> <p>50 00 694 362 06/88 →</p>  <p>71-31114-00 6x</p> <p>00 00 157 841</p> 	<p>71-37732-00</p> <p>50 10 240 658</p> 	<p>81-37914-00  K↔</p> <p>50 10 359 806 90x110 A SL RD PTFE</p>  <p>81-37933-00  K↔</p> <p>50 10 359 807 150x172 A SL LD PTFE</p> 	

RENAULT

Ltr.   

9,8 MIDR 06.20.45 D/41 219 kW (298 PS) MAXTER 02/96-06/97

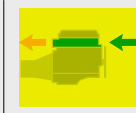

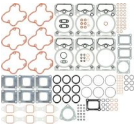

02-31116-02
50 00 793 734

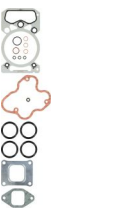

03-31116-01
00 00 323 761



08-37732-03
50 01 826 447

61-31115-00 6x
50 10 295 726
128 Ø
1,25 mm





71-31116-00 6x
50 00 694 271





70-25824-20 6x
00 24 472 534



71-31113-00  6x
00 00 771 193





71-37213-00  6x
50 10 295 218





71-37732-00
50 10 240 658



81-37914-00 
50 10 359 806
90x110
A SL RD PTFE



81-37933-00 
50 10 359 807
150x172
A SL LD PTFE





9,8 MIDR 06.20.45 E/41 249 kW (339 PS) MAXTER 10/92-06/97

02-31116-02
50 00 793 734



08-37732-03
50 01 826 447





61-31115-00 6x
50 10 295 726
128 Ø
1,25 mm



71-31116-00 6x
50 00 694 271



71-37691-00  U 6x
50 10 330 375

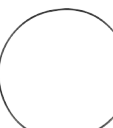

71-37692-00  0 2x
50 10 330 381

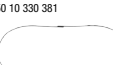

70-25824-20 6x
00 24 472 534



71-37829-00  2x
50 00 694 362





71-31114-00  6x
00 00 157 841





71-37732-00
50 10 240 658



81-37914-00 
50 10 359 806
90x110
A SL RD PTFE



81-37933-00 
50 10 359 807
150x172
A SL LD PTFE



9,8 MIDR 06.20.45 M41 222-250 kW (302-340 PS) ARES ILIADÉ 04/98
MIDR 06.20.45 R41

61-31115-00 6x
50 10 295 726
128 Ø
1,25 mm



71-31116-00 6x
50 00 694 271



70-25824-20 12x
00 24 472 534























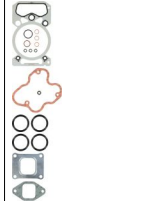



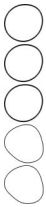

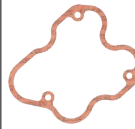

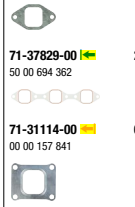

71-37829-00  2x
50 00 694 362

























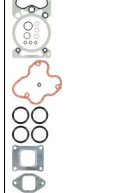



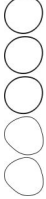

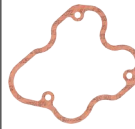

RENAULT

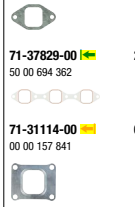
Ltr.  9,8 MIDS 06.20.45 192-202 kW (261-275 PS) C-Serie 10/82-10/98
MIDS 06.20.45 B G-Serie





										
	<p>02-31116-02 50 00 793 734</p>  <p>03-31116-01 00 00 323 761</p> 	<p>08-37732-01 50 01 826 448 1 → 10/85</p>  <p>08-37732-02 50 01 826 446 1 → 11/85 → 1 → 05/88</p>  <p>08-37732-03 50 01 826 447 1 → 06/88 →</p> 	<p>15-73295-01  6x</p> 	<p>61-31115-00 6x 50 10 295 726 128 Ø 1,25 mm</p> 		<p>71-31116-00 6x 50 00 694 271</p> 	<p>70-25824-20 6x 00 24 472 534</p> 	<p>71-31113-00  6x 00 00 771 193</p> <p>71-37829-00  2x 50 00 694 362</p> <p>71-31114-00  6x 00 00 157 841</p> 	<p>71-37732-00 50 10 240 658</p> 	<p>81-25013-30  50 10 339 722 80x100 B SL RD PTFE 1 → 10/85</p>  <p>81-37914-00  50 10 359 806 90x110 A SL RD PTFE 1 → 11/85 →</p>  <p>81-37933-00  50 10 359 807 150x172 A SL LD PTFE</p> 

RENAULT

Ltr. 		
9,8 MIDS 06.20.45 B	192-202 kW (261-275 PS) C-Serie G-Serie	10/82-10/98













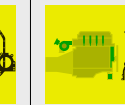
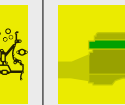
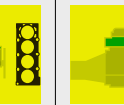

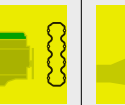
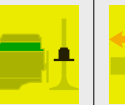
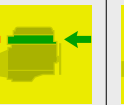





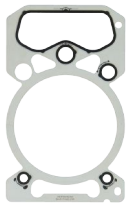
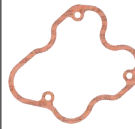

										
	<p>02-31116-02 50 00 793 734</p>  <p>03-31116-01 00 00 323 761</p> 	<p>08-37732-01 50 01 826 448 1 → 10/85</p>  <p>08-37732-02 50 01 826 446 1 → 11/85 → 1 → 05/88</p>  <p>08-37732-03 50 01 826 447 1 → 06/88 →</p> 	<p>15-73295-01  6x</p> 	<p>61-31115-00 6x 50 10 295 726 128 Ø 1,25 mm</p> 		<p>71-31116-00 6x 50 00 694 271</p> 	<p>70-25824-20 6x 00 24 472 534</p> 	<p>71-31113-00  6x 00 00 771 193</p> <p>71-37829-00  2x 50 00 694 362</p> <p>71-31114-00  6x 00 00 157 841</p> 	<p>71-37732-00 50 10 240 658</p> 	<p>81-25013-30  50 10 339 722 80x100 B SL RD PTFE 1 → 10/85</p>  <p>81-37914-00  50 10 359 806 90x110 A SL RD PTFE 1 → 11/85 →</p>  <p>81-37933-00  50 10 359 807 150x172 A SL LD PTFE</p> 

9,8 MIHR 06.20.45 A41	185 kW (252 PS) TRACER	01/91
-----------------------	------------------------	-------













				<p>61-31115-00 6x 50 10 295 726 128 Ø 1,25 mm</p> 		<p>71-31116-00 6x 50 00 694 271</p> 	<p>70-31112-00 12x 50 10 295 494</p> 	<p>71-37829-00  2x 50 00 694 362</p> 		
--	--	--	--	--	--	---	--	---	--	--

RENAULT

















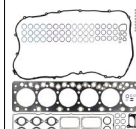

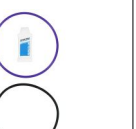

Ltr.   
 9,8 MIPR 06.20.45 A3 222 kW (302 PS)

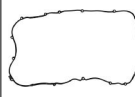















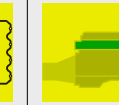
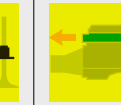
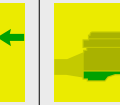











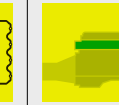
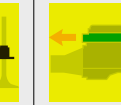
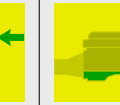



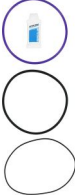















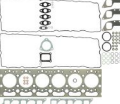



















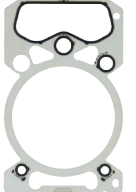

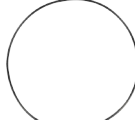



											
	02-31116-02 50 00 793 734			61-31115-00 6x 50 10 295 726 128 Ø 1,25 mm		71-31116-00 6x 50 00 694 271	70-31112-00 12x 50 10 295 494	71-31113-00  6x 00 00 771 193	71-31114-00  6x 00 00 157 841	71-37732-00 50 10 240 658	81-25013-30  50 10 339 722 80x100 B SL RD PTFE  10/85
											 81-37914-00  50 10 359 806 90x110 A SL RD PTFE  11/85→
											 81-37933-00  50 10 359 807 150x172 A SL LD PTFE

9,8 MIPS 06.20.45 B 176-186 kW (240-253 PS)

























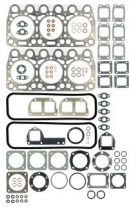
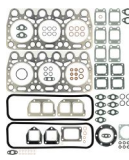

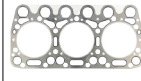

















	02-31116-02 50 00 793 734			61-31115-00 6x 50 10 295 726 128 Ø 1,25 mm		71-31116-00 6x 50 00 694 271	70-31112-00 12x 50 10 295 494	71-31113-00  6x 00 00 771 193	71-31114-00  6x 00 00 157 841  08/93	71-37732-00 50 10 240 658	
											
											
											

10,8 DT111 279-338 kW (379-460 PS) C-Serie
 DT111-122HH D-Series
 DT111-122HI K-Series
 DT111-122HJ T-Series
 01/13

















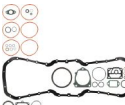
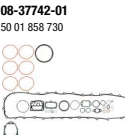

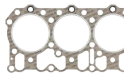



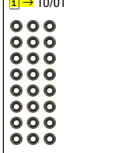
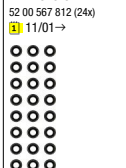

















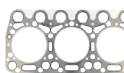

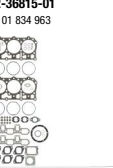
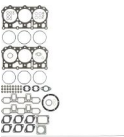



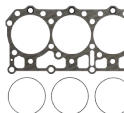
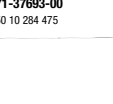
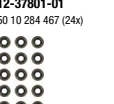
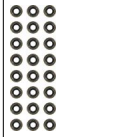

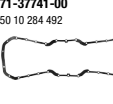

	02-36435-04 74 22 499 254	08-42117-02 74 22 106 469	15-42947-01  6x 74 85 103 699	61-36435-10 74 20 495 935 136 Ø 1,25 mm		71-11866-00 74 21 487 571	12-37804-01 74 20 864 662 (24x)	71-37843-00  74 20 850 506	71-37892-00  6x 74 21 482 601	71-39191-00  74 20 812 484	81-38651-00  74 21 347 087 136x159 A SL RD PTFE
			  								 81-37941-00  74 08 148 259 150x180 AB SL LD
							70-37804-00 24x 74 20 864 662				

RENAULT														
Ltr. 														
10,8 DXi 11	243-339 kW (330-460 PS)	KERAX PREMIUM 2 DISTRIBUTION PREMIUM 2 LANDER PREMIUM 2 ROUTE	10/05		02-36435-02 50 01 866 493 +74 20 850 506 +74 21 482 601 (6x)	08-37748-01 50 01 868 169 	15-42947-01  74 85 103 699 	61-36435-10 74 20 495 935 136 Ø 1,25 mm 		71-39074-00 74 20 804 638 	12-37804-01 74 20 864 662 (24x)  70-37804-00 74 20 864 662 24x 	71-37843-00  74 20 850 506  71-37892-00  74 21 482 601 6x 	71-39191-00  74 20 812 484  71-42117-00  74 21 517 690 	81-38651-00  74 21 347 087 136x159 A SL RD PTFE  81-37941-00  74 08 148 259 150x180 AB SL LD 
11,1 dCi 11 B/43 dCi 11C dCi 11E dCi 11G dCi 11-270	195-303 kW (265-412 PS)	KERAX PREMIUM DISTRIBUTION PREMIUM ROUTE	08/00		02-36830-01 50 01 857 432 	08-37747-01 50 01 855 172 		61-36830-00 50 10 477 117 128 Ø 1,3 mm 		71-37697-00 50 10 295 777 	12-37802-01 50 10 330 133 (12x)  70-37802-00 50 10 330 133 12x 	71-33377-00  50 10 477 090  71-33378-00  50 10 477 091  71-37889-00  50 10 477 331 3x 	71-37747-00 50 10 550 818 	81-37921-00  50 01 861 755 90x120 A SL RD PTFE  81-37938-00  50 10 295 831 160x190 A SL LD PTFE 
11,1 MIDR 06.23.56 A/3 MIDR 06.23.56 A/41 MIDR 06.23.56 B/41	255-288 kW (347-392 PS)	ILIADÉ KERAX PREMIUM DISTRIBUTION PREMIUM ROUTE	04/96		02-31115-01 50 01 834 578 	08-37737-01 50 01 834 579 	15-37737-01  00 00 157 968 (2x) +50 03 065 201 (1x) +50 03 065 159 (1x) 	61-31115-00 6x 50 10 295 726 128 Ø 1,25 mm 		71-31116-00 6x 50 00 694 271  71-37691-00  50 10 330 375  71-37692-00  50 10 330 381 	12-31112-02 50 10 295 494 (6x)  70-31112-00 6x 50 10 295 494 	71-37829-00  50 00 694 362  71-37213-00  50 10 295 218 6x 	71-37737-00 50 10 330 152 	81-37914-00  50 10 359 806 90x110 A SL RD PTFE  81-37933-00  50 10 359 807 150x172 A SL LD PTFE 























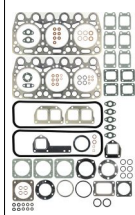
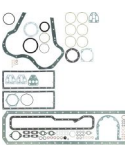
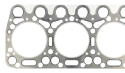



















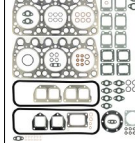

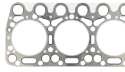







RENAULT

<p>Ltr.   </p>											
<p>11,9 MIDR 06.35.40 C 224-228 kW (305-310 PS) R-Serie 10/80-03/89</p>	<p>02-37145-01 50 01 825 563 12/85</p>  <p>02-37145-02 50 00 793 752 01/86→</p> 	<p>08-37736-03 50 01 830 814</p> 		<p>61-37145-00 2x 50 01 847 781 139 Ø 1,4 mm MLS</p> 		<p>71-37689-00 2x 50 00 678 440</p> 		<p>71-37829-00  2x 50 00 694 362</p>  <p>71-37879-00 1x 50 00 666 737</p>  <p>71-37881-00 2x 50 00 666 736</p>  <p>71-37882-00 50 00 666 738</p> 	<p>71-37736-00 50 00 693 229</p> 	<p>81-25013-30  50 10 339 722 80x100 B SL RD PTFE</p>  <p>81-37934-00  50 03 087 026 130x150 A SL LD PTFE</p>  <p>81-37946-00 N 00 24 472 710 10x30 A</p> 	
<p>11,9 MIDR 06.35.40 H 275 kW (374 PS) R-Serie 10/87-05/90</p>	<p>02-37145-01 50 01 825 563</p> 	<p>08-37736-03 50 01 830 814</p> 		<p>61-37145-00 2x 50 01 847 781 139 Ø 1,4 mm MLS</p> 		<p>71-37689-00 2x 50 00 678 440</p> 		<p>71-37834-00  6x 50 00 693 288</p>  <p>71-37879-00 1x 50 00 666 737</p>  <p>71-37881-00 2x 50 00 666 736</p>  <p>71-37882-00 50 00 666 738</p> 	<p>71-37736-00 50 00 693 229</p> 	<p>81-25013-30  50 10 339 722 80x100 B SL RD PTFE</p>  <p>81-37934-00  50 03 087 026 130x150 A SL LD PTFE</p>  <p>81-37946-00 N 00 24 472 710 10x30 A</p> 	

RENAULT

<p>Ltr.   </p> <p>12,0 MACK E.TECH A/46 295-353 kW (401-480 PS) MAGNUM 05/00 MACK E.TECH B/46 MACK E.TECH C/46</p>		 <p>02-36810-01 50 01 852 973</p> 	 <p>08-37741-01 50 01 852 974</p>  <p>08-37742-01 50 01 858 730</p> 		 <p>61-36810-00 2x 50 01 848 220 127 Ø 2,1 mm</p> 		 <p>71-37693-00 2x 50 10 284 475</p>	 <p>12-37801-01 50 10 284 467 (24x) 11/01→</p>  <p>12-42546-01 52 00 567 812 (24x) 11/01→</p>  <p>70-37801-00 24x 50 10 284 467 11/01→</p>  <p>70-42546-00 24x 52 00 567 812 11/01→</p> 	 <p>71-37836-00  2x 52 00 540 584</p>  <p>71-37884-00  6x 50 10 284 657</p> 	 <p>71-37741-00 50 10 284 492</p>  <p>71-37742-00 52 00 523 379</p> 	 <p>81-37917-00   52 00 590 535 B SL RD PTFE</p>  <p>81-37937-00   50 01 834 679 B SL LD PTFE</p> 
<p>12,0 MDS 06.35.40 A 206 kW (280 PS)</p>					<p>61-37145-00 2x 50 01 847 781 139 Ø 1,4 mm MLS</p> 					<p>71-37736-00 50 00 693 229</p> 	
<p>12,0 MIDR 06.24.65 A/42 287-346 kW (390-471 PS) MAGNUM 09/96 MIDR 06.24.65 B/42 MIDR 06.24.65 C/42</p>		 <p>02-36815-01 50 01 834 963</p> 	 <p>08-37741-02 50 01 834 964</p> 		 <p>61-36815-00 2x 50 01 834 870 127 Ø 2,3 mm</p> 		 <p>71-37693-00 2x 50 10 284 475</p>	 <p>12-37801-01 50 10 284 467 (24x)</p>  <p>70-37801-00 24x 50 10 284 467</p> 	 <p>71-37836-00  2x 52 00 540 584</p>  <p>71-37884-00  6x 50 10 284 657</p> 	 <p>71-37741-00 50 10 284 492</p> 	 <p>81-37917-00   52 00 590 535 B SL RD PTFE</p>  <p>81-37937-00   50 01 834 679 B SL LD PTFE</p> 

RENAULT

























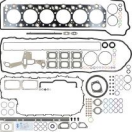





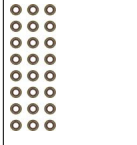









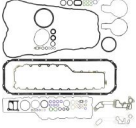



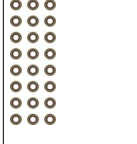













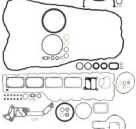



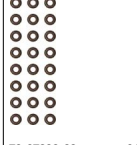





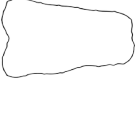





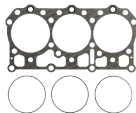

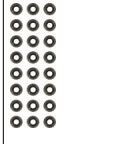
<p>Ltr. </p>	<p>12.0 MIDR 06.35.40</p>	<p>206 kW (280 PS)</p>	<p>TBH</p>	<p>01/77-06/80</p>														
<p>12.0 MIDR 06.35.40</p>	<p>206 kW (280 PS)</p>	<p>TBH</p>	<p>01/77-06/80</p>		<p>02-37145-01 50 01 825 563</p> 	<p>08-37736-03 50 01 830 814</p> 	<p>61-37145-00 2x 50 01 847 781 139 Ø 1,4 mm MLS</p> 	<p>71-37689-00 2x 50 00 678 440</p> 	<p>71-37689-00 2x 50 00 678 440</p> 	<p>71-37689-00 2x 50 00 678 440</p> 	<p>71-37829-00  2x 50 00 694 362</p> 	<p>71-37879-00  1x 50 00 666 737</p> 	<p>71-37881-00  2x 50 00 666 736</p> 	<p>71-37882-00  50 00 666 738</p> 	<p>71-37736-00 50 00 693 229</p> 	<p>81-25013-30 K  50 10 339 722 80x100 B SL RD PTFE</p> 	<p>81-37934-00 K  50 03 087 026 130x150 A SL LD PTFE</p> 	<p>81-37946-00 N 00 24 472 710 10x30 A</p> 
<p>12.0 MIDR 06.35.40 G</p>	<p>247-259 kW (336-352 PS)</p>	<p>CBH CLM R-Serie</p>	<p>03/86-10/92</p>		<p>02-37145-02 50 00 793 752  05/88</p> 	<p>08-37736-03 50 01 830 814</p> 	<p>61-37145-00 2x 50 01 847 781 139 Ø 1,4 mm MLS</p> 	<p>71-37689-00 2x 50 00 678 440</p> 	<p>71-37689-00 2x 50 00 678 440</p> 	<p>12-37798-01 50 01 859 093 (6x)</p> 	<p>71-37834-00  6x 50 00 693 288</p> 	<p>71-37879-00  1x 50 00 666 737</p> 	<p>71-37881-00  2x 50 00 666 736</p> 	<p>71-37882-00  50 00 666 738</p> 	<p>71-37736-00 50 00 693 229</p> 	<p>81-25013-30 K  50 10 339 722 80x100 B SL RD PTFE</p> 	<p>81-37934-00 K  50 03 087 026 130x150 A SL LD PTFE</p> 	<p>81-37946-00 N 00 24 472 710 10x30 A</p> 

RENAULT

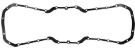

Ltr.	Midr.	PS	Motor	Year	Image 1	Image 2	Image 3	Image 4	Image 5	Image 6	Image 7	Image 8	Image 9	Image 10	Image 11
12.0	MIDR 06.35.40 G	259 kW (352 PS)	CBH MAJOR R-Serie	01/90-01/93											
						02-37145-01 50 01 825 563 	08-37736-03 50 01 830 814 		61-37145-00 2x 50 01 847 781 139 Ø 1,4 mm MLS 		71-37689-00 2x 50 00 678 440 	12-37798-01 2x 50 01 859 093 (6x) 	71-37834-00 6x 50 00 693 288 71-37879-00 1x 50 00 666 737 71-37881-00 2x 50 00 666 736 71-37882-00 50 00 666 738 	71-37736-00 50 00 693 229 	81-25013-30 K↔ 50 10 339 722 80x100 B SL RD PTFE 81-37934-00 K↔ 50 03 087 026 130x150 A SL LD PTFE 81-37946-00 N 00 24 472 710 10x30 A
12.0	MIDR 06.35.40 H	275-283 kW (374-385 PS)	CBH CLM MAGNUM MAJOR R-Serie	01/90-10/96											
						02-37145-01 50 01 825 563 	08-37736-03 50 01 830 814 		61-37145-00 2x 50 01 847 781 139 Ø 1,4 mm MLS 		71-37689-00 2x 50 00 678 440 		71-37834-00 6x 50 00 693 288 71-37879-00 1x 50 00 666 737 71-37881-00 2x 50 00 666 736 71-37882-00 50 00 666 738 	71-37736-00 50 00 693 229 	81-25013-30 K↔ 50 10 339 722 80x100 B SL RD PTFE 81-37934-00 K↔ 50 03 087 026 130x150 A SL LD PTFE 81-37946-00 N 00 24 472 710 10x30 A
12.0	MIDR 06.35.40 J1	305-314 kW (415-427 PS)	MAJOR	04/92-10/96											
						02-36800-01 50 01 830 802 	08-37736-01 50 01 830 801 		61-36800-00 2x 50 00 678 639 142 Ø 1,4 mm 		71-37689-00 2x 50 00 678 440 		71-37832-00 2x 50 00 693 159 71-37878-00 4x 50 10 248 715 	71-37736-00 50 00 693 229 	81-37914-00 K↔ 50 10 359 806 90x110 A SL RD PTFE 81-37934-00 K↔ 50 03 087 026 130x150 A SL LD PTFE

RENAULT

Ltr.														
12,0	MIDR 06.35.40 J/3 MIDR 06.35.40 L1 MIDR 06.35.40 M3 MIDR 06.35.40 N/3	236-314 kW (321-427 PS)	CBH CLM MAGNUM MAJOR	05/91-10/98										
					<p>02-36800-01 50 01 830 802</p>	<p>08-37736-01 50 01 830 801 1 → 08/95</p> <p>08-37736-02 50 01 834 315 1 → 09/95 →</p>		<p>61-36800-00 2x 50 00 678 639 142 Ø 1,4 mm</p>		<p>71-37689-00 2x 50 00 678 440</p>		<p>71-37832-00 2x 50 00 693 159</p> <p>71-37878-00 4x 50 10 248 715</p>	<p>71-37736-00 50 00 693 229</p>	<p>81-37914-00 K 50 10 359 806 90x110 A SL RD PTFE</p> <p>81-37934-00 K 50 03 087 026 130x150 A SL LD PTFE</p>
12,0	MIDR 06.35.40 J/3 MIDR 06.35.40 P/41	305 kW (415 PS)	MAGNUM MAJOR	04/92-12/96				<p>61-36800-00 2x 50 00 678 639 142 Ø 1,4 mm</p>		<p>71-37689-00 2x 50 00 678 440</p>		<p>71-37832-00 2x 50 00 693 159</p> <p>71-37878-00 4x 50 10 248 715</p>	<p>71-37736-00 50 00 693 229</p>	<p>81-37914-00 K 50 10 359 806 90x110 A SL RD PTFE</p> <p>81-37934-00 K 50 03 087 026 130x150 A SL LD PTFE</p>
12,0	MIDS 06.35.40 D	208 kW (283 PS)	CBH CLM	04/86-10/92				<p>61-37145-00 2x 50 01 847 781 139 Ø 1,4 mm MLS</p>		<p>71-37689-00 2x 50 00 678 440</p>	<p>12-37798-01 50 01 859 093 (6x)</p> <p>70-37798-00 50 01 859 093</p>	<p>71-37834-00 6x 50 00 693 288</p> <p>71-37879-00 2x 50 00 666 737</p> <p>71-37881-00 2x 50 00 666 736</p>	<p>71-37736-00 50 00 693 229</p>	<p>81-25013-30 K 50 10 339 722 80x100 B SL RD PTFE</p> <p>81-37934-00 K 50 03 087 026 130x150 A SL LD PTFE</p> <p>81-37946-00 N 00 24 472 710 10x30 A</p>

RENAULT														
Ltr. 														
12,1 DXi 12	324-353 kW (441-480 PS)	MAGNUM	10/04-04/06	01-36260-03 50 01 866 153 +74 03 099 100  	02-36260-03 50 01 866 152 +74 20 463 858 +74 08 170 959 (6x)  				15-36526-01  71-36526-00 74 20 710 235 	12-37804-01 74 20 864 662 (24x)  70-37804-00 74 20 864 662 	71-37187-00  74 20 463 858  71-33889-00  74 08 170 959 6x 	71-37749-00 74 20 532 272 	81-35206-10  74 85 108 352 180x205 A SL PTFE (Polytetrafluorethylen)/FPM (Fluor-Kautschuk) 	
12,8 DT113 DT113-122HK DT113-122HL DT113-122HM	323-382 kW (439-520 PS)	C-Serie K-Serie T-Serie	01/13		02-36855-03 74 22 164 943 	08-37751-02 74 21 581 522 	15-76926-06  74 00 270 950 	61-36855-10 74 21 510 072 147 Ø 		71-13208-00 74 22 777 560 	12-37804-01 74 20 864 662 (24x)  70-37804-00 74 20 864 662 	71-37846-00  74 20 805 850  71-37894-10  74 20 855 371 6x 	71-37751-00  74 20 541 940  71-39192-10  74 21 293 367 	81-38651-00  74 21 347 087 136x159 A SL RD PTFE  81-35206-10  74 85 108 352 180x205 A SL PTFE (Polytetrafluorethylen)/FPM (Fluor-Kautschuk) 
12,8 DXi 13	323-382 kW (440-520 PS)	KERAX MAGNUM	05/06		02-36855-01 50 01 867 441 	08-37751-01 50 01 867 442 	15-76926-06  74 00 270 950 	61-36855-10 74 21 510 072 147 Ø 		71-37703-00 74 20 538 793 	12-37806-01 74 20 802 229 (24x)  70-37806-00 74 20 802 229 	71-37846-00  74 20 805 850  71-37894-10  74 20 855 371 6x 	71-37751-00 74 20 541 940 	81-38651-00  74 21 347 087 136x159 A SL RD PTFE  81-35206-10  74 85 108 352 180x205 A SL PTFE (Polytetrafluorethylen)/FPM (Fluor-Kautschuk) 
12,8 MIDR 06.24.65 B/42	316 kW (430 PS)	MAGNUM	09/96		02-36815-01 50 01 834 963 	08-37741-02 50 01 834 964 		61-36815-00 2x 50 01 834 870 127 Ø 2,3 mm 		71-37693-00 2x 50 10 284 475 	12-37801-01 50 10 284 467 (24x)  70-37801-00 50 10 284 467 	71-37836-00  52 00 540 584  71-37884-00  50 10 284 657 6x 	71-37741-00 50 10 284 492 	81-37917-00  52 00 590 535 B SL RD PTFE  81-37937-00  50 01 834 679 B SL LD PTFE 

RENAULT

Ltr.  16,4 Mack-EE9-560 412 kW (560 PS) MAGNUM  04/96

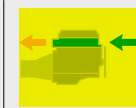

16,4 Mack-EE9-560 412 kW (560 PS) MAGNUM 04/96

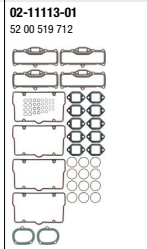



08-11233-01
50 01 832 284

15-10185-01  8x
50 00 823 015 (3x)



61-10125-00 4x
50 00 823 025
151,5 Ø
1,75 mm



71-11113-00 4x
50 01 834 126

71-11232-00  4x
50 00 823 055

71-11114-00  10x
52 00 294 767

71-11233-00
52 00 368 558

81-10443-00  
50 00 823 113
B PTFE

81-37937-00  
50 01 834 679
B SL LD PTFE

16,5 EE9-502 368-390 kW (500-530 PS) MAGNUM 09/90
Mack-EE9-530

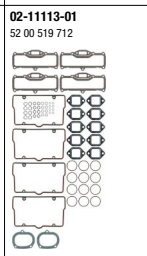

08-11233-01
50 01 832 284

15-10185-01  8x
50 00 823 015 (3x)



61-10125-00 4x
50 00 823 025
151,5 Ø
1,75 mm



71-11113-00 4x
50 01 834 126

71-11232-00  4x
50 00 823 055

71-11114-00  10x
52 00 294 767

71-11233-00
52 00 368 558

81-10443-00  
50 00 823 113
B PTFE

81-37937-00  
50 01 834 679
B SL LD PTFE

Haftungsausschluss

(für Katalog)

Alle Angaben in unserem Katalog wurden von uns sorgfältig geprüft, sind jedoch unverbindlich. Ersatzansprüche wegen Katalogangaben werden von uns nicht anerkannt. Der Käufer ist selbst verpflichtet, zu prüfen, ob unsere Teile für seine Zwecke geeignet sind. In allen Zweifelsfällen sollte Rücksprache mit unserem technischen Kundendienst erfolgen **Tel. +49 731 7046 999**.

Technische Weiterentwicklungen oder Änderungen bleiben vorbehalten, soweit damit keine Nachteile für den Kunden verbunden sind.

Angaben, Namens- und Markenzeichen, Beschreibungen, Nummern von Fahrzeugnummern und Herstellerzeichen, Original-Ersatzteilnummern der Fahrzeug- und Motorenhersteller u. a. sind ausschließlich für interne Zwecke gedacht. Solche Kennzeichnungen dürfen Fahrzeugbesitzern gegenüber nicht verwendet werden.

Wir weisen ausdrücklich darauf hin, dass alle von uns gelieferten Teile von geschultem Fachpersonal einzubauen sind. Reinz haftet für Fehler in diesem Katalog nur, wenn diese für den Kunden nicht offenbar erkennbar sind sowie nur bei Vorsatz und grober Fahrlässigkeit von Reinz, eines Vertreters oder eines Erfüllungsgehilfen. Dieser Haftungsausschluss gilt nicht im Rahmen

des Anwendungsbereichs des Produkthaftungsgesetzes und nicht bei Verletzung von Körper, Leben und Gesundheit, sowie bei der Verletzung von sog. Kardinalpflichten. Darüber hinaus ist unsere Haftung für Schäden, insbesondere für Personen-, Sach- oder Vermögensschäden, die unmittelbar oder mittelbar im Zusammenhang mit der Nutzung dieses Kataloges auftreten, sowie für nicht voraussehbare Schäden ausgeschlossen.

Reinz ist Inhaber aller Schutzrechte an den in diesem Katalog gespeicherten Daten. Kopie, Nachdruck, ganze oder teilweise Übernahme der Inhalte und Vervielfältigung, auch auszugsweise, ist nur mit unserer vorheriger schriftlicher Zustimmung sowie mit unserem Urheberrechtsvermerk zulässig.

Für Bestellungen, welche ab dem Erscheinungsdatum eines neuen Katalogs getätigt werden, sind alleine die Angaben des neuen Katalogs maßgeblich. Auf Angaben im Vorkatalog kann bei Neubestellungen nicht mehr zurückgegriffen werden.

Sofern Sie noch Fragen haben, bitten wir Sie, sich mit uns in Verbindung zu setzen.

VictorReinz.com/AGB

Exclusion of Liability

(for catalog)

All details in our catalog have been thoroughly checked by us but are however not binding. Right to damages on account of catalog details will not be recognized. The purchaser is obliged to check if our parts are suitable for their use. In all doubtful cases, the purchaser should consult our technical customer service under **+49 731 7046 999**.

We reserve the right to further technical developments or changes as long as no disadvantage for the customer results.

Details, name and trademarks, descriptions, numbers from vehicle numbers and manufacturer symbols, original vehicle replacement part numbers and engine manufacturer etc. are solely for internal use. Such labels must not be used with vehicle owners.

We specifically point out that all parts supplied by us must be assembled by trained specialists.

Reinz is liable for mistakes in this catalog only when they are not clearly recognizable for the customer, as well as by intent or gross negligence on the part of Reinz, its representative or vicarious agent. This exclusion of liability does not apply within the framework of the field of

application of the product liability laws and not by bodily harm, life and health, as well as by violation of cardinal duties. In addition, our liability for damages, especially personal, property or financial damages that occur directly or indirectly as a result of the use of this catalog, as well as non-foreseeable damages are excluded.

Reinz is the owner of all patent rights on the data stored in this catalog. Copies, reprints, whole or partial takeover of the contents and duplication even in excerpts are only permissible with our prior written approval, as well as with our copyright note.

For orders placed after the publication date of a new catalog, only the details in the new catalog are binding and no fall back to details in the previous catalog is possible.

In case you have further questions, do not hesitate to contact us.

VictorReinz.com/AGB

VictorReinz.com

reinz.info@dana.com

Technical Hotline +49 (0)731 7046-9 99

REINZ-Dichtungs-GmbH

Reinzstrasse 3-7
89233 Neu-Ulm
Germany
+49 (0)731 7046-0

VICTOR REINZ[®]

