

**VICTOR REINZ®**



**VOLVO**  
**Q3 / 2023**



**[VictorReinz.com/online-catalog](https://VictorReinz.com/online-catalog)**

# Victor Reinz®

## at a Glance



### Online Catalog

[VictorReinz.com/online-catalog](https://VictorReinz.com/online-catalog)



### Newsletter

[VictorReinz.com/EN/News/Newsletter.aspx?region](https://VictorReinz.com/EN/News/Newsletter.aspx?region)



### Youtube

[www.youtube.com/user/VictorReinzSealingEN](https://www.youtube.com/user/VictorReinzSealingEN)



### Catalog News

[VictorReinz.com/news](https://VictorReinz.com/news)



### Technical Service Information

[VictorReinz.com/tsi](https://VictorReinz.com/tsi)



### Facebook

[www.facebook.com/VictorReinzParts](https://www.facebook.com/VictorReinzParts)



### Just seal it!

[VictorReinz.com/jsi](https://VictorReinz.com/jsi)



### Technical Datasheet

[VictorReinz.com/jsi-datasheet](https://VictorReinz.com/jsi-datasheet)



### LinkedIn

[www.linkedin.com/showcase/victor-reinz-emea](https://www.linkedin.com/showcase/victor-reinz-emea)



### Safety Datasheet

[VictorReinz.com/jsi-datasheet](https://VictorReinz.com/jsi-datasheet)



### Homepage

[VictorReinz.com](https://VictorReinz.com)

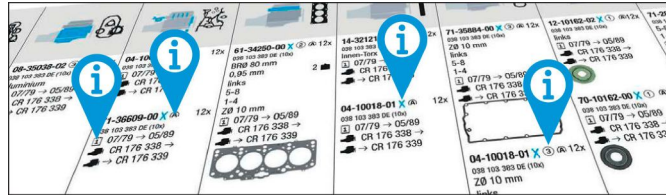

[VictorReinz.com/catalog-info](https://VictorReinz.com/catalog-info)

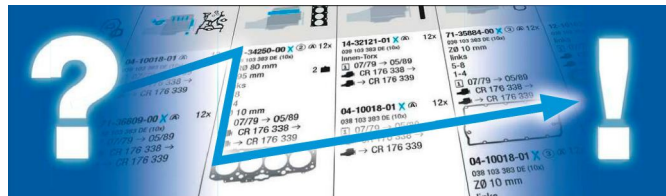

[VictorReinz.com/catalog-how-to-use](https://VictorReinz.com/catalog-how-to-use)

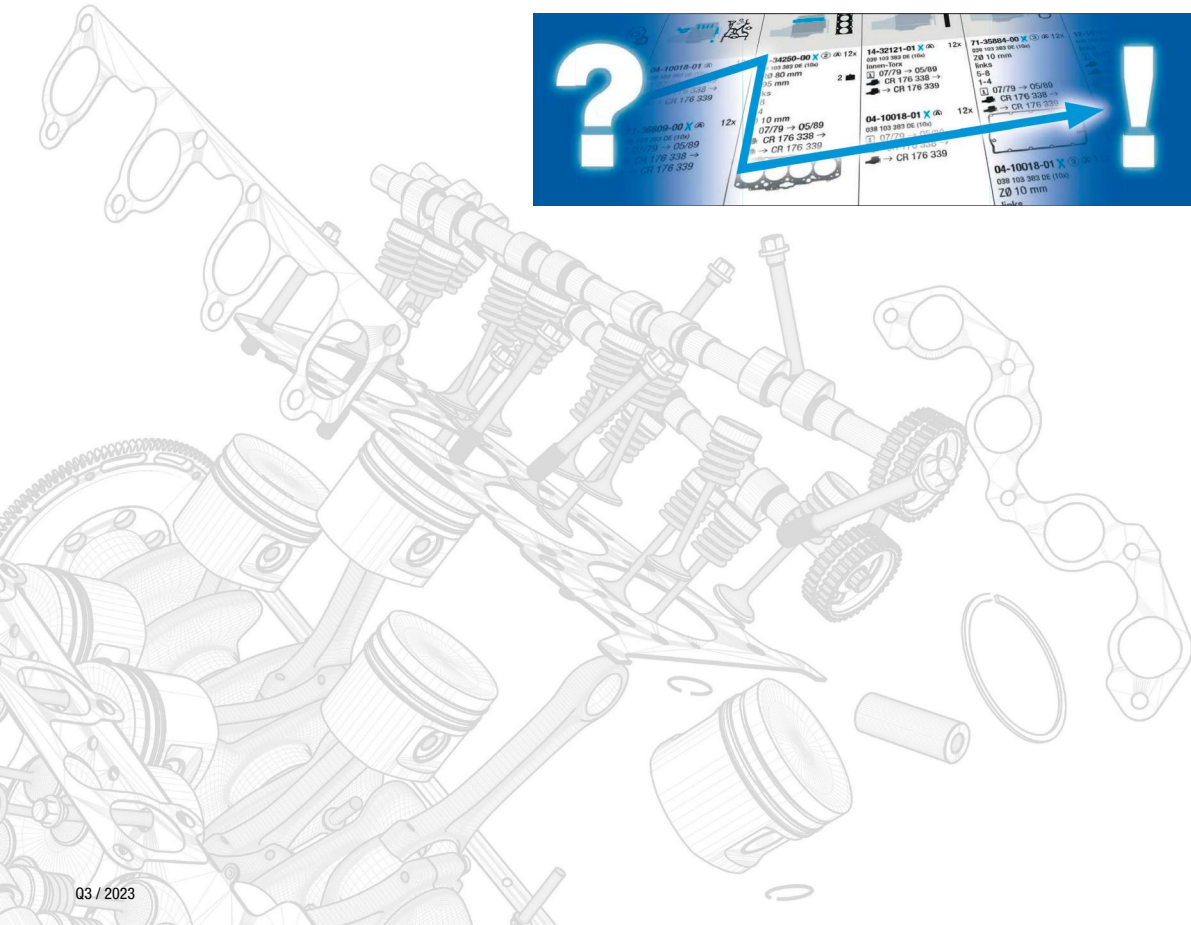

# VOLVO



**D**

D 100 A	13
D 100 B	13
D 16A	29
D 50 A	6
D 50 B	6
D 60 A	7
D 70 A	9
D 70 B	9
D10A320	14
D10A360	14
D11-325	23
D11-355	23
D11-365	23
D11-385	23
D11-405	23
D11B390	23
D11B430	23
D11C330	23
D11C370	23
D11C380	23
D11C410	23
D11C430	23
D11C450	23
D11C460	23
D11K330	23
D11K370	23
D11K380	23
D11K410	23
D11K430	23
D11K450	23
D11K460	23
D12A340	27
D12A380	27
D12A420	27
D12C340	27
D12C380	27
D12C390	27
D12C420	27
D12C460	27
D12D340	27
D12D365	27
D12D380	27
D12D390	27
D12D395	27



D12D420	27
D12D425	27
D12D435	27
D12D460	27
D12D465	27
D12D500	28
D13400	28
D13435	28
D13465	28
D13500	28
D13A360	28
D13A380	28
D13A400	28
D13A420	28
D13A440	28
D13A460	28
D13A480	28
D13A500	28
D13A520	28
D13B360	28
D13B400	28
D13B440	28
D13B500	28
D13C380	28
D13C420	28
D13C440	28
D13C460	28
D13C480	28
D13C500	28
D13C520	28
D13C540	28
D13F335	28
D13F375	28
D13F405	28
D13F425	28
D13F435	28
D13F485	28
D13F515	28
D13H375	28
D13H405	28
D13H425	28
D13H435	28
D13H440	28
D13H455	28
D13H475	28



D13H500	28
D13J375	28
D13J405	28
D13J425	28
D13J435	28
D13J455	28
D13J475	28
D13J500	28
D13K420	29
D13K420S	29
D13K440	29
D13K460	29
D13K460S	29
D13K460T	29
D13K480	29
D13K500	29
D13K500S	29
D13K500T	29
D13K520	29
D13K540	29
D13K540S	29
D13M375	28
D13M405	28
D13M425	28
D13M435	28
D13M455	28
D13M500	28
D16A470	30
D16A520	30
D16B520	30
D16C550	30
D16C610	30
D16E540	30
D16E580	30
D16E660	30
D16G540	30
D16G600	30
D16G700	29-30
D16G750	29-30
D16K550	30
D16K650	30
D16K750	30
D4A140	6
D5K210	6
D5K240	6



D6A180	7
D6A210	7
D6A230	7
D6A250	7
D6B	7
D6B 180	7
D6B 220	7
D6B 250	7
D7A230	9
D7A260	9
D7A285	10
D7B230	10
D7B260	10
D7C215	12
D7C250	12
D7C275	12
D7C290	12
D7C310	12
D7E240	12
D7E280	12
D7E290	12
D7E320	12
D8K250	12
D8K280	12
D8K320	12
D8K350	12
D9A260	13
D9A300	13
D9A340	13
D9A380	13
D9B260	13
D9B300	13
D9B310	13
D9B340	13
D9B360	13
D9B380	13
DH10A245	14
DH10A285	14
DH10A360	14
DH12D340	26
DH12D380	26
DH12D420	26
DH12E340	27
DH12E380	27
DH12E420	27



DH12E460	27
<b>T</b>	
TD 100 A	13, 15
TD 100 B	13
TD 100 BG	13
TD 100 G	15
TD 100 GA	15
TD 101 F	16
TD 101 FA	16
TD 101 FC	17
TD 101 FD	17
TD 101 G	16
TD 101 GA	15
TD 101 GB	15
TD 101 GE	15
TD 102 F	17-18
TD 102 FAQ	18
TD 102 FBQ	19
TD 102 FCQ	18
TD 102 FD	18
TD 102 FDQ	18
TD 102 FEQ	18
TD 102 FF	19
TD 102 FGQ	18
TD 102 FH	17-18
TD 102 FL	17-18
TD 102 FM	18
TD 102 FQ	18
TD 102 FS	18
TD 102 FT	18
TD 103 E	18
TD 103 EA	18
TD 103 ES	18
TD 103 KB	18
TD 103 KF	18
TD 120 A	24
TD 120 C	24
TD 120 D	24
TD 120 E	24
TD 120 F	24
TD 120 FA	24
TD 120 FB	24
TD 120 FC	24
TD 120 FTQ	24

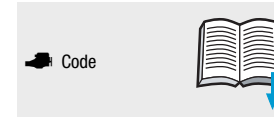

TD 120 G	25
TD 120 GA	24
TD 121 F	25
TD 121 FA	25
TD 121 FB	25
TD 121 FC	25
TD 121 FD	25
TD 121 FE	25
TD 121 FF	25
TD 121 FG	25
TD 121 FH	25
TD 121 FK	25
TD 121 G	25
TD 121 GD	25
TD 122 F	23, 26
TD 122 FA	26
TD 122 FAQ	26
TD 122 FBQ	26
TD 122 FCQ	26
TD 122 FH	26
TD 122 FK	26
TD 122 FKQ	26
TD 122 FL	26
TD 122 FR	23, 26
TD 122 FS	26
TD 123 E	23
TD 123 EA	26
TD 123 EB	26
TD 123 EC	26
TD 123 ED	26
TD 123 ES	23, 26
TD 162 F	30
TD 162 FJ	30
TD 162 FL	30
TD 162 FS	30
TD 163 ES	30
TD 50 A	6
TD 50 B	6
TD 60 A	7
TD 60 B	8
TD 60 C	8
TD 60 D	8
TD 60 DG	8
TD 61 F	8
TD 61 FB	8

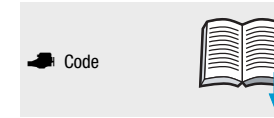

TD 61 G	8
TD 61 GA	8
TD 61 GB	8
TD 61 GC	8
TD 61 GE	8
TD 61 GS	8
TD 63 E	8
TD 63 ES	8
TD 70 A	9
TD 70 B	9
TD 70 C	9
TD 70 D	9
TD 70 E	9
TD 70 F	11
TD 70 FS	11
TD 70 G	11
TD 70 H	9
TD 70 HA	9
TD 71 A	11
TD 71 ACE	11
TD 71 AG	11
TD 71 AGP	11
TD 71 AP	11
TD 71 APB	11
TD 71 AW	11
TD 71 F	11
TD 71 FA	11
TD 71 FC	11
TD 71 FD	11
TD 71 FQ	11
TD 71 FS	11
TD 71 FSQ	11
TD 73 E	11
TD 73 EA	11
TD 73 EB	11
TD 73 ES	11
THD 100 A	20
THD 100 D	20
THD 100 DA	21
THD 100 DB	21
THD 100 DC	21
THD 100 DD	21
THD 100 E	22
THD 100 EA	22
THD 100 EB	22

# VOLVO



THD 100 EC .....	22
THD 100 ED .....	22
THD 100 EE .....	22
THD 100 EK .....	22
THD 101 B .....	22
THD 101 GB .....	22
THD 101 GC .....	22
THD 101 GD .....	22
THD 101 KB .....	22
THD 101 KC .....	22
THD 101 KE .....	22
THD 102 KA .....	23
THD 102 KB .....	22
THD 102 KD .....	22
THD 102 KE .....	23
THD 102 KF .....	22
THD 102 KJ .....	22
THD 103 E .....	22
THD 103 ES .....	22
THD 103 KB .....	22
THD 103 KD .....	22
THD 103 KF .....	22

VOLVO												
Ltr.												
4,0	D4A140		<b>02-41465-02</b> 3 094 795 	<b>08-41463-01</b> 85 103 850 		<b>61-41465-00</b> 3 976 803 105 Ø 		<b>71-94589-00</b> 11 708 206 	<b>12-93421-01</b> 3 976 841 (4x) +3 976 842 (4x)  <b>70-93421-00 AS</b> 4x 3 976 841  <b>70-93422-00 ES</b> 4x 3 976 842 	<b>71-94557-00</b> 2x 3 796 779 	<b>71-41463-00</b> 11 997 979 	<b>81-10099-00 K</b> 6 613 348 60,3x79,4 AB RD FPM/ACM <b>81-10283-02 K</b> 6 212 971 133,3x158,7 A SL LD FPM 
5,1	D 50 A D 50 B TD 50 A TD 50 B	<b>01-25025-06</b> 275 740-9 (2x) +270 766-9 +270 770-1 +270 779-2 	<b>02-25025-03</b> 275 740-9 (2x) +270 766-9 +270 770-1 	<b>08-25034-03</b> 270 779-2 	<b>15-76820-01</b> 6x 275 460-4 	<b>61-25025-20</b> 2x 275 740-9 107 Ø 1,25 mm 		<b>15-25033-01</b> 270 770-1 	<b>12-25051-01</b> 411 166-2 (12x)  <b>70-25051-00</b> 12x 411 166-2 	<b>11-25035-01</b> 3x 270 766-9 	<b>71-25034-20</b> 420 025-9 	<b>40-75195-00 K</b> 421 131-4 89x76,2 Filz <b>40-75196-00 K</b> 421 147-0 127x140 Filz 
5,1	D5K210 D5K240		<b>02-10147-01</b> 21 914 900 	<b>08-11736-01</b> 21 914 897 		<b>61-10147-00</b> 22 231 933 114,5 Ø 1,15 mm MLS 	<b>14-11702-01</b> 993 799 (14x) +993 802 (4x) +984 757 (1x) +975 192 (1x) 	<b>71-11781-00</b> 2x 21 717 476 	<b>12-37804-02</b> 20 864 662 (16x)  <b>70-37804-00</b> 16x 20 864 662 	<b>71-11685-00</b> 4x 21 698 165 	<b>71-11736-00</b> 21 537 231 	<b>81-10466-00 K</b> 21 481 950 <b>81-10463-00 K</b> 21 230 631 
								<b>71-11782-00</b> 2x 21 717 615 		<b>71-11685-01</b> 3x 21 914 906 	<b>71-11689-00</b> 4x 21 742 293 	

VOLVO												
5,5	D 60 A TD 60 A											
		<b>01-25025-06</b> 275 740-9 (2x) +270 766-9 +270 770-1 +270 779-2	<b>02-25025-03</b> 275 740-9 (2x) +270 766-9 +270 770-1	<b>08-25034-03</b> 270 779-2	<b>15-76073-02</b> 271 162-0	<b>61-25025-20</b> 2x 275 740-9 107 Ø 1,25 mm		<b>15-25033-01</b> 270 770-1	<b>12-25051-01</b> 411 166-2 (12x)	<b>11-25035-01</b> 270 766-9	<b>71-25034-20</b> 420 025-9	<b>40-75195-00</b> 421 131-4 89x76,2 Filz  <b>40-75196-00</b> 421 147-0 127x140 Filz  <b>81-26294-10</b> 477 119-2 127x150 AB SL LD FPM
5,5	D6A180 D6A210 D6A230 D6A250											
		<b>02-31081-01</b> 276 873 +276 872	<b>08-34848-01</b> 276 874	<b>15-76073-01</b> 271 161-2	<b>61-31090-10</b> 2x 276 821-6 112,5 Ø	<b>14-32282-01</b> 2x 465 840 (20x)	<b>71-31081-00</b> 2x	<b>12-34914-01</b> 859 171 (12x)	<b>70-34914-00</b> 12x 859 171	<b>70-31414-10</b> 276 872 <b>11-31079-03</b> 276 872	<b>71-34848-00</b> 420 941-7	<b>81-31168-00</b> 477 118-4 76,2x101,68 A FILZ RD FPM  <b>81-26294-10</b> 477 119-2 127x150 AB SL LD FPM
5,5	D6B D6B 180 D6B 220 D6B 250											
					<b>61-31090-10</b> 2x 276 821-6 112,5 Ø		<b>15-31081-01</b> 275 776-3	<b>12-34914-01</b> 859 171 (12x)	<b>11-31079-01</b> 270 764-4	<b>71-31079-00</b> 420 538	<b>71-34848-00</b> 420 941-7	

VOLVO												
5,5	TD 60 B TD 60 C TD 60 D TD 60 DG	<b>01-25025-07</b> 275 740-9 (2x) +270 762-8 +270 768-5 +270 778-4 	<b>02-25025-04</b> 275 740-9 (2x) +270 762-8 +270 768-5 	<b>08-25034-04</b> 270 778-4 	<b>15-76073-02</b> 271 162-0 	<b>61-25025-20</b> 2x 275 740-9 107 Ø 1,25 mm 		<b>15-25033-02</b> 270 762-8 	<b>12-26365-01</b> 465 551-0 (12x)  <b>70-26365-00</b> 465 551-0 	<b>11-25052-01</b> 270 768-5 	<b>71-25034-20</b> 420 025-9 	<b>40-75195-00</b> 421 131-4 89x76,2 Filz  <b>40-75196-00</b> 421 147-0 127x140 Filz  <b>81-26294-10</b> 477 119-2 127x150 AB SL LD FPM 
5,5	TD 61 F TD 61 FB TD 61 G TD 61 GA TD 61 GB TD 61 GC TD 61 GE TD 61 GS TD 63 E TD 63 ES	<b>01-31090-01</b> 276 821-6 (2x) +270 764-4 +270 774-3 +275 776-3 	<b>02-31090-01</b> 276 821-6 (2x) +270 764-4 +275 776-3 	<b>08-25034-05</b> 270 774-3 	<b>15-76073-01</b> 271 161-2 	<b>61-31090-10</b> 2x 276 821-6 112,5 Ø 	<b>14-32282-01</b> 2x 465 840 (20x) 	<b>15-31081-01</b> 275 776-3 	<b>12-26365-01</b> 465 551-0 (12x)  <b>70-26365-00</b> 465 551-0 	<b>11-31079-01</b> 270 764-4 	<b>71-25034-20</b> 420 025-9  <b>71-34848-00</b> 420 941-7 	<b>81-31168-00</b> 477 118-4 76,2x101,68 A FILZ RD FPM  <b>40-75196-00</b> 421 147-0 127x140 Filz  <b>81-26294-10</b> 477 119-2 127x150 AB SL LD FPM 













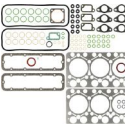





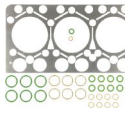

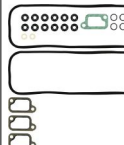

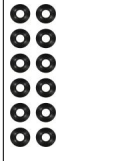

















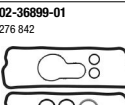
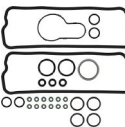
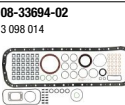

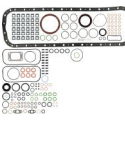

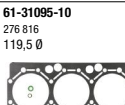
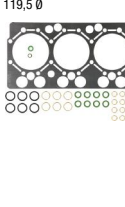
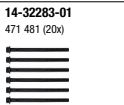

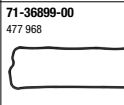







**VOLVO**

Ltr.

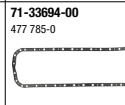

6,7 D 70 A  
D 70 B  
TD 70 A  
TD 70 B  
TD 70 C  
TD 70 D  
TD 70 E  
TD 70 H  
TD 70 HA

 <p><b>01-23155-04</b> 275 525-4 (2x) +270 761-0 +270 771-9 +270 957-4</p> 	 <p><b>02-23155-02</b> 275 525-4 (2x) +270 761-0 +270 771-9</p> 	 <p><b>08-24837-03</b> 270 957-4</p> 	 <p><b>15-76804-04</b>  6x 271 160-4</p> 	 <p><b>61-23155-10</b> 2x 275 525-4 114,4 Ø 1,25 mm</p> 		 <p><b>15-24850-02</b> 270 761-0</p>  <p><b>71-24850-00</b> 2x 421 066-2</p> 	 <p><b>12-27127-01</b> 469 456-8 (12x)</p>  <p><b>70-27127-00</b> 12x 469 456-8</p> 	 <p><b>11-24853-02</b>    270 771-9</p> 	 <p><b>71-24837-10</b> 421 025-8</p> 	 <p><b>40-75195-00</b>  421 131-4 89x76,2 Filz</p>  <p><b>40-75196-00</b>  421 147-0 127x140 Filz</p>  <p><b>81-26294-10</b>  477 119-2 127x150 AB SL LD FPM</p> 
<p>6,7 D7A230 D7A260</p>	 <p><b>02-36899-01</b> 276 842</p> 	 <p><b>08-33694-02</b> 3 098 014</p> 	 <p><b>15-76804-03</b>  6x 271 159-6</p> 	 <p><b>61-31095-10</b> 2x 276 816 119,5 Ø</p> 	 <p><b>14-32283-01</b> 2x 471 481 (20x)</p> 	 <p><b>71-36899-00</b> 2x 477 968</p> 	 <p><b>12-34914-01</b> 859 171 (12x)</p>  <p><b>70-34914-00</b> 12x 859 171</p> 	 <p><b>70-31414-10</b>  276 175-7</p>  <p><b>11-31083-02</b>    276 175-7</p>  <p><b>71-31083-00</b> 2x 471 650-2</p> 	 <p><b>71-33694-00</b> 477 785-0</p> 	 <p><b>81-31168-00</b>  477 118-4 76,2x101,68 A FILZ RD FPM</p>  <p><b>81-26294-10</b>  477 119-2 127x150 AB SL LD FPM</p> 

**VOLVO**

Ltr.  

6,7 D7A285

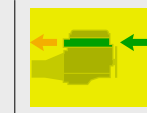

**02-36899-01**  
276 842



**08-33694-02**  
3 098 014



**15-76804-03**  6x  
271 159-6

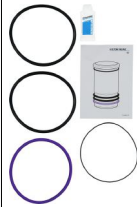

**61-31095-10** 2x  
276 816  
119,5 Ø



**14-32283-01** 2x  
471 481 (20x)

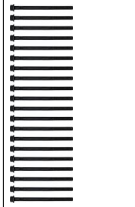



**71-36899-00** 2x  
477 968



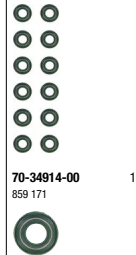

**12-34914-01**  
859 171 (12x)

**70-34914-00**  
859 171



**70-31414-10**    
477 118-4  
76,2x101,68  
A FILZ RD FPM

**11-31083-02**    
276 175-7

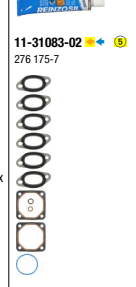

**71-33694-00**  
477 785-0



**81-31168-00**   
477 118-4  
76,2x101,68  
A FILZ RD FPM

**81-26294-10**   
477 119-2  
127x150  
AB SL LD FPM



6,7 D7B230  
D7B260

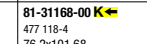
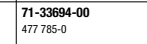
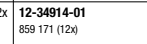
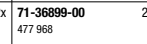
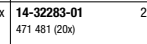
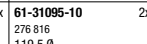
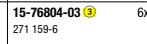
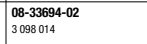
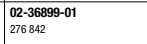



**02-36899-01**  
276 842



**08-33694-02**  
3 098 014



**15-76804-03**  6x  
271 159-6



**61-31095-10** 2x  
276 816  
119,5 Ø



**14-32283-01** 2x  
471 481 (20x)

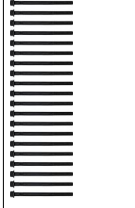



**71-36899-00** 2x  
477 968



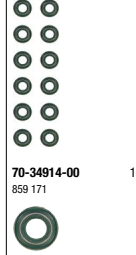

**12-34914-01**  
859 171 (12x)

**70-34914-00**  
859 171



**70-31414-10**    
477 118-4  
76,2x101,68  
A FILZ RD FPM

**11-31083-02**    
276 175-7

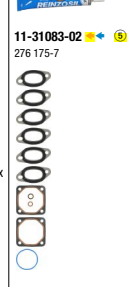

**71-33694-00**  
477 785-0



**81-31168-00**   
477 118-4  
76,2x101,68  
A FILZ RD FPM

**81-26294-10**   
477 119-2  
127x150  
AB SL LD FPM



VOLVO												
6,7	TD 70 F TD 70 FS TD 70 G	<b>01-23155-05</b> 275 525-4 (2x) +270 761-0 +270 771-9 +270 777-6	<b>02-23155-02</b> 275 525-4 (2x) +270 761-0 +270 771-9	<b>08-24837-06</b> 270 777-6	<b>15-76804-04</b> 271 160-4 6x	<b>61-23155-10</b> 2x 275 525-4 114,4 Ø 1,25 mm		<b>15-24850-02</b> 270 761-0	<b>12-27127-01</b> 469 456-8 (12x)	<b>11-24853-02</b> 270 771-9	<b>71-24837-10</b> 421 025-8	<b>40-75195-00</b> 421 131-4 89x76,2 Filz  <b>40-75196-00</b> 421 147-0 127x140 Filz  <b>81-26294-10</b> 477 119-2 127x150 AB SL LD FPM
6,7	TD 71 A TD 71 ACE TD 71 AG TD 71 AGP TD 71 AP TD 71 APB TD 71 AW TD 71 F TD 71 FA TD 71 FC TD 71 FD TD 71 FQ TD 71 FS TD 71 FSQ	<b>01-31095-01</b> 275 779-7 (2x) +270 765-1 +270 775-0 +275 781-3	<b>02-31095-01</b> 275 779-7 (2x) +270 765-1 +275 781-3	<b>08-24837-04</b> 270 775-0	<b>15-76804-03</b> 271 159-6 6x	<b>61-31095-10</b> 2x 276 816 119,5 Ø	<b>14-32283-01</b> 2x 471 481 (20x)	<b>15-31104-01</b> 275 781-3	<b>12-27127-01</b> 469 456-8 (12x)	<b>11-31083-01</b> 270 765-1	<b>71-24837-10</b> 421 025-8  <b>71-33694-00</b> 477 785-0	<b>81-31168-00</b> 477 118-4 76,2x101,68 A FILZ RD FPM  <b>81-26294-10</b> 477 119-2 127x150 AB SL LD FPM
6,7	TD 73 E TD 73 EA TD 73 EB TD 73 ES	<b>01-31095-02</b>	<b>02-31095-02</b> 276 816 (2x) +3 098 378 +276 175-7	<b>08-24837-05</b>	<b>15-76804-03</b> 271 159-6 6x	<b>61-31095-10</b> 2x 276 816 119,5 Ø	<b>14-32283-01</b> 2x 471 481 (20x)	<b>15-31104-02</b> 3 098 378	<b>12-34914-01</b> 859 171 (12x)	<b>11-31083-02</b> 276 175-7	<b>71-24837-10</b> 421 025-8  <b>71-33694-00</b> 477 785-0	<b>81-31168-00</b> 477 118-4 76,2x101,68 A FILZ RD FPM  <b>81-26294-10</b> 477 119-2 127x150 AB SL LD FPM

VOLVO														
7,1	D7E240 D7E280 D7E290 D7E320		<b>02-36840-01</b> 21 226 240 	<b>08-42048-01</b> 21 079 028 	<b>15-73536-01</b> 6x 20 412 762 (2x) 	<b>61-36840-00</b> 20 980 440 109,5 Ø 1,15 mm 		<b>71-39468-00</b> 20 788 793 	<b>12-34914-03</b> 20 459 855 (24x) 	<b>71-37842-00</b> 6x 20 794 356 	<b>70-31414-10</b> 	<b>81-35899-00</b> 20 412 568 81x104 FPM 		
7,3	D7C215 D7C250 D7C275 D7C290 D7C310	<b>01-31095-03</b> 	<b>02-31095-04</b> 	<b>08-33694-01</b> 3 098 379 	<b>15-76804-03</b> 6x 271 159-6 	<b>61-31095-10</b> 2x 276 816 119,5 Ø 	<b>14-32283-01</b> 2x 471 481 (20x) 	<b>71-31104-00</b> 2x 471 520 	<b>12-34914-01</b> 859 171 (12x) 	<b>70-31414-10</b> 	<b>11-31083-02</b> 276 175-7 	<b>71-31083-00</b> 6x 471 650-2 	<b>71-33694-00</b> 477 785-0 	<b>81-31168-00</b> 477 118-4 76,2x101,68 A FILZ RD FPM 
7,7	D8K250 D8K280 D8K320 D8K350		<b>02-10149-01</b> 21 914 899 	<b>08-11697-01</b> 21 914 895 		<b>61-10149-00</b> 22 231 946 114,5 Ø 1,3 mm MLS 	<b>14-11702-02</b> 993 799 (20x) +993 802 (6x) +984 757 (1x) +975 192 (1x) 	<b>71-11797-00</b> 21 717 748 	<b>12-37804-01</b> 20 864 662 (24x) 	<b>71-11685-00</b> 6x 21 698 165 	<b>11-11685-02</b> 21 914 905 	<b>71-11689-00</b> 6x 21 742 293 	<b>71-11697-00</b> 21 492 627 	<b>81-10466-00</b> 21 481 950 

VOLVO												
9,4	D9A260 D9A300 D9A340 D9A380 D9B260 D9B300 D9B310 D9B340 D9B360 D9B380		<b>02-36435-01</b> 20 515 369 	<b>08-39191-02</b> 20 505 492 	<b>15-42947-01</b> 85 103 699 	<b>61-36435-10</b> 20 495 935 136 Ø 1,25 mm 		<b>71-39074-00</b> 20 804 638 	<b>12-34914-03</b> 20 459 855 (24x)  <b>70-34914-00</b> 859 171 24x 	<b>70-31414-10</b>  <b>71-37892-00</b> 21 482 601 6x 	<b>71-39191-00</b> 20 812 484  <b>71-42117-00</b> 21 517 690 	<b>81-38651-00</b> 21 347 087 136x159 A SL RD PTFE  <b>81-37941-00</b> 8 148 259 150x180 AB SL LD 
9,6	D 100 A D 100 B TD 100 A TD 100 B TD 100 BG	<b>01-23160-06</b> 275 551-0 (6x) +270 958-2 +276 034-6 +276 122-9 	<b>02-23160-03</b> 275 551-0 (6x) +270 958-2 +276 034-6 	<b>08-24860-04</b> 276 122-9 	<b>15-76807-03</b> 271 158-8 	<b>61-23160-10</b> 6x 275 551-0 130 Ø 1,4 mm 		<b>15-24360-01</b> 276 034-6  <b>71-24359-00</b> 6x 423 145-2 	<b>12-27127-01</b> 469 456-8 (12x)  <b>70-27127-00</b> 469 456-8 12x 	<b>11-24361-03</b> 270 958-2 	<b>71-24860-10</b> 422 025-7 	<b>40-75197-00</b> 422 146-1 85,7x98,5 Filz  <b>40-75198-00</b> 422 145-3 155x168 Filz  58275  <b>81-36602-00</b> 20 441 687 155x180 AB SL LD FPM 58276→ 

**VOLVO**

Ltr.



9,6 DH10A245  
DH10A285  
DH10A360



**01-27190-03**  
270 789-1 (6x)  
+276 035-3  
+276 052-8  
+276 123-7



**02-27190-02**  
270 789-1 (6x)  
+276 035-3  
+276 052-8

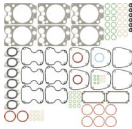

**08-31517-01**

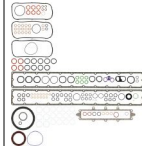

**15-76086-01** 6x



**61-27190-10** 6x  
270 789-1  
137 Ø  
1,4 mm

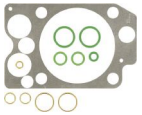

**15-26296-02**

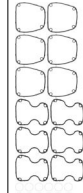

**71-26296-10** 6x  
424 693 0

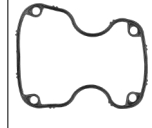

**71-26297-10** 6x  
424 694-8

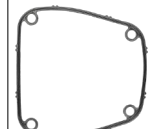

**11-31088-01** 276 052-8

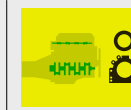
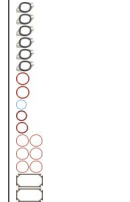

**81-25952-20**   
424 983-5  
85,73x114,33  
A SL RD FPM



**81-36602-00**   
20 441 697  
155x180  
AB SL LD FPM



9,6 D10A320  
D10A360

**01-27190-03**  
270 789-1 (6x)  
+276 035-3  
+276 052-8  
+276 123-7



**02-27190-02**  
270 789-1 (6x)  
+276 035-3  
+276 052-8

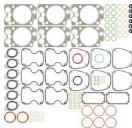

**08-24860-05**

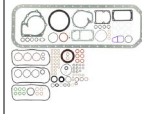

**15-76086-01** 6x

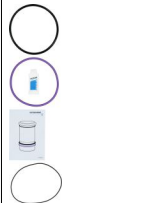

**61-27190-10** 6x  
270 789-1  
137 Ø  
1,4 mm

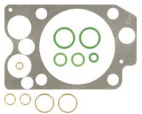

**15-26296-01**

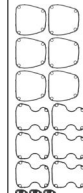

**71-26296-10** 6x  
424 693 0

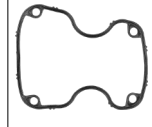

**71-26297-10** 6x  
424 694-8

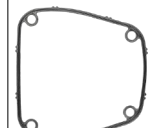

**11-31088-01** 276 052-8

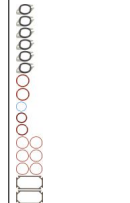

**71-24860-10**

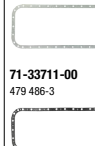

**71-33711-00**  
479 486-3



**81-25952-20**   
424 983-5  
85,73x114,33  
A SL RD FPM



**81-36602-00**   
20 441 697  
155x180  
AB SL LD FPM



VOLVO												
9,6	TD 100 A	<p><b>01-23160-06</b> 275 551-0 (6x) +270 958-2 +276 034-6 +276 122-9</p>	<p><b>02-23160-03</b> 275 551-0 (6x) +270 958-2 +276 034-6</p>	<p><b>08-24860-04</b> 276 122-9</p>	<p><b>15-76807-03</b>  271 158-8  → 199157</p>	<p><b>61-23160-10</b> 6x 275 551-0 130 Ø 1,4 mm</p>		<p><b>15-24360-01</b> 276 034-6</p>	<p><b>12-27127-01</b> 469 456-8 (12x)</p>	<p><b>11-24361-03</b>  270 958-2</p>	<p><b>71-24860-10</b> 422 025-7</p>	<p><b>40-75197-00</b>  422 146-1 85,7x98,5 Filz</p> <p><b>40-75198-00</b>  422 145-3 155x168 Filz  → 58275</p> <p><b>81-36602-00</b>  20 441 697 155x180 AB SL LD FPM  → 58276 →</p>
9,6	TD 100 G TD 100 GA TD 101 GA TD 101 GB TD 101 GE	<p><b>01-27190-02</b> 270 789-1 (6x) +276 035-3 +276 052-8 +276 122-9</p>	<p><b>02-27190-02</b> 270 789-1 (6x) +276 035-3 +276 052-8</p>	<p><b>08-24860-04</b> 276 122-9</p>	<p><b>15-76807-03</b>  271 158-8</p>	<p><b>61-27190-10</b> 6x 270 789-1 137 Ø 1,4 mm</p>		<p><b>15-26296-01</b> 276 035-3</p>		<p><b>11-31088-01</b>  276 052-8</p>	<p><b>71-24860-10</b> 422 025-7</p>	<p><b>40-75197-00</b>  422 146-1 85,7x98,5 Filz  → 168545</p> <p><b>81-25952-20</b>  424 983-5 85,73x114,33 A SL RD FPM  → 168546 →</p> <p><b>81-36602-00</b>  20 441 697 155x180 AB SL LD FPM</p>

VOLVO													
9,6	TD 101 F TD 101 FA TD 101 G	56683 56683 56683	<b>01-27190-02</b> 270 789-1 (6x) +276 035-3 +276 052-8 +276 122-9 	<b>02-27190-02</b> 270 789-1 (6x) +276 035-3 +276 052-8 	<b>08-24860-04</b> 276 122-9 	<b>15-76807-03</b> 271 158-8 199157  <b>15-76086-01</b> 271 157-0 199158→ 	<b>61-27190-10</b> 6x 270 789-1 137 Ø 1,4 mm 		<b>15-26296-01</b> 276 035-3  <b>71-26296-10</b> 6x 424 693 0  <b>71-26297-10</b> 6x 424 694-8 		<b>11-31088-01</b> 276 052-8 	<b>71-24860-10</b> 422 025-7 	<b>40-75197-00</b> 422 146-1 85,7x98,5 Filz 168545  <b>81-25952-20</b> 424 983-5 85,73x114,33 A SL RD FPM 168546→  <b>81-36602-00</b> 20 441 697 155x180 AB SL LD FPM 
9,6	TD 101 F TD 101 FA TD 101 G	306000→ 306000→ 306000→ 306000→	<b>01-27190-03</b> 270 789-1 (6x) +276 035-3 +276 052-8 +276 123-7 	<b>02-27190-02</b> 270 789-1 (6x) +276 035-3 +276 052-8 	<b>08-24860-05</b> 276 123-7 	<b>15-76807-03</b> 271 158-8 199157  <b>15-76086-01</b> 271 157-0 199158→ 	<b>61-27190-10</b> 6x 270 789-1 137 Ø 1,4 mm 		<b>15-26296-01</b> 276 035-3  <b>71-26296-10</b> 6x 424 693 0  <b>71-26297-10</b> 6x 424 694-8 		<b>11-31088-01</b> 276 052-8 	<b>71-24860-10</b> 422 025-7 	<b>40-75197-00</b> 422 146-1 85,7x98,5 Filz 168545  <b>81-25952-20</b> 424 983-5 85,73x114,33 A SL RD FPM 168546→  <b>81-36602-00</b> 20 441 697 155x180 AB SL LD FPM 



**VOLVO**

Ltr.

TD 101 FC  
TD 101 FD



9,6  
+276 035-3  
+276 052-8  
+276 123-7

**01-27190-03**  
270 789-1 (6x)  
+276 035-3  
+276 052-8  
+276 123-7

**02-27190-02**  
270 789-1 (6x)  
+276 035-3  
+276 052-8

**08-24860-05**  
276 123-7

**15-76807-03** 6x  
271 158-8  
199157

**61-27190-10** 6x  
270 789-1  
137 Ø  
1,4 mm

**15-26296-01**  
276 035-3

**11-31088-01** 6x  
276 052-8

**71-24860-10**  
422 025-7

**81-25952-20 K**  
424 983-5  
85,73x114,33  
A SL RD FPM

**81-36602-00 K**  
20 441 697  
155x180  
AB SL LD FPM

9,6  
TD 102 F  
TD 102 FH  
TD 102 FL

**01-27190-03**  
270 789-1 (6x)  
+276 035-3  
+276 052-8  
+276 123-7

**02-27190-02**  
270 789-1 (6x)  
+276 035-3  
+276 052-8

**08-24860-05**  
276 123-7

**15-76086-01** 6x  
271 157-0  
199158

**61-27190-10** 6x  
270 789-1  
137 Ø  
1,4 mm

**15-26296-01**  
276 035-3

**11-31088-01** 6x  
276 052-8













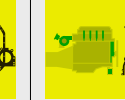
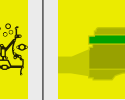
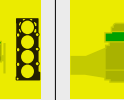

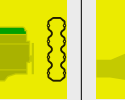
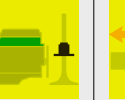
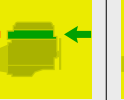

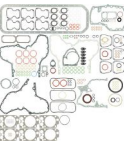
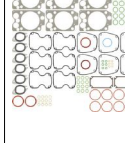



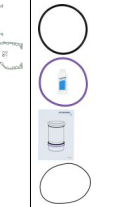
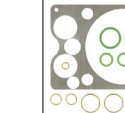
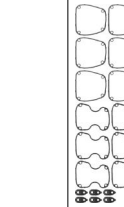

**71-24860-10**  
422 025-7

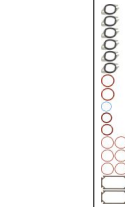
**81-25952-20 K**  
424 983-5  
85,73x114,33  
A SL RD FPM











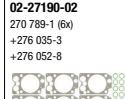
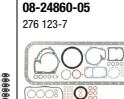

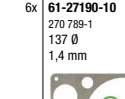
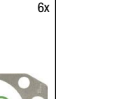
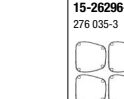
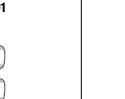
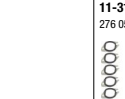

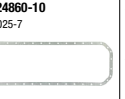

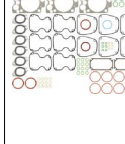
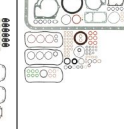

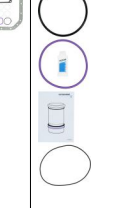

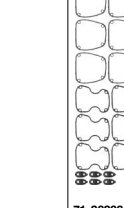

**81-36602-00 K**  
20 441 697  
155x180  
AB SL LD FPM

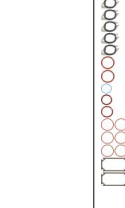

**VOLVO**













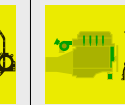
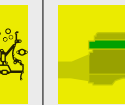
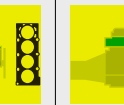

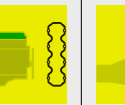
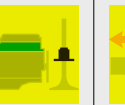
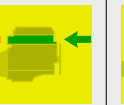

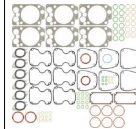
Ltr.    
 9,6 TD 102 F  N 10 306000→  
 TD 102 FH  N 10 306000→  
 TD 102 FL  N 10 306000→

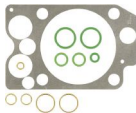
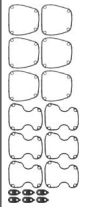

											
<b>01-27190-02</b> 270 789-1 (6x) +276 035-3 +276 052-8 +276 122-9 	<b>02-27190-02</b> 270 789-1 (6x) +276 035-3 +276 052-8 	<b>08-24860-04</b> 276 122-9 	<b>15-76086-01</b>   271 157-0 6x 	<b>61-27190-10</b> 6x 270 789-1 137 Ø 1,4 mm 		<b>15-26296-01</b> 276 035-3 			<b>11-31088-01</b>    276 052-8 	<b>71-24860-10</b> 422 025-7 	<b>81-25952-20</b>   424 983-5 85,73x114,33 A SL RD FPM  <b>81-36602-00</b>   20 441 697 155x180 AB SL LD FPM 











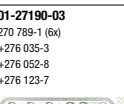
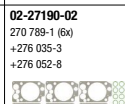
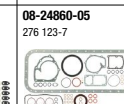
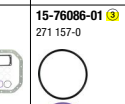
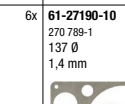
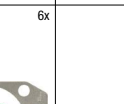
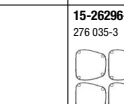
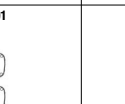
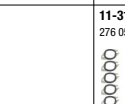
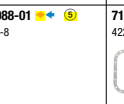
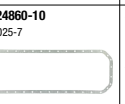
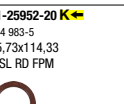

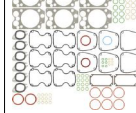

9,6 TD 102 FAQ  
 TD 102 FCQ  
 TD 102 FD  
 TD 102 FDQ  
 TD 102 FEQ  
 TD 102 FGQ  
 TD 102 FM  
 TD 102 FQ  
 TD 102 FS  
 TD 102 FT  
 TD 103 E  
 TD 103 EA  
 TD 103 ES  
 TD 103 KB  
 TD 103 KF

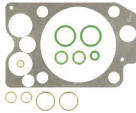
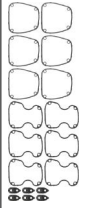
											
<b>01-27190-03</b> 270 789-1 (6x) +276 035-3 +276 052-8 +276 123-7 	<b>02-27190-02</b> 270 789-1 (6x) +276 035-3 +276 052-8 	<b>08-24860-05</b> 276 123-7 	<b>15-76086-01</b>   271 157-0 6x 	<b>61-27190-10</b> 6x 270 789-1 137 Ø 1,4 mm 		<b>15-26296-01</b> 276 035-3 			<b>11-31088-01</b>    276 052-8 	<b>71-24860-10</b> 422 025-7 	<b>81-25952-20</b>   424 983-5 85,73x114,33 A SL RD FPM  <b>81-36602-00</b>   20 441 697 155x180 AB SL LD FPM 

**VOLVO**  
Ltr.    
9,6 TD 102 FBQ

											
	<b>02-27190-02</b> 270 789-1 (6x) +276 035-3 +276 052-8 		<b>15-76086-01</b>  271 157-0 	<b>61-27190-10</b> 6x 270 789-1 137 Ø 1,4 mm 		<b>15-26296-01</b> 276 035-3 			<b>11-31088-01</b>  276 052-8 	<b>71-24860-10</b> 422 025-7 	<b>81-25952-20 K</b>  424 983-5 85,73x114,33 A SL RD FPM  <b>81-36602-00 K</b>  20 441 697 155x180 AB SL LD FPM 

9,6 TD 102 FF  F10 314000→  
 F10 314000→







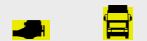





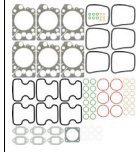

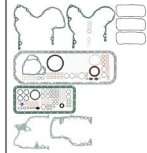

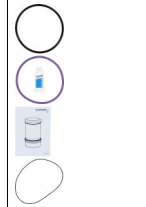

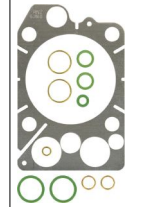

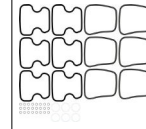
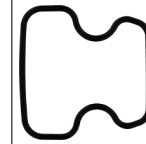

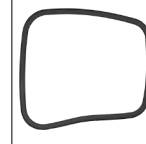

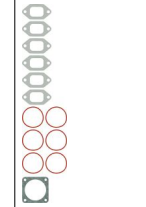

											
<b>01-27190-03</b> 270 789-1 (6x) +276 035-3 +276 052-8 +276 123-7 	<b>02-27190-02</b> 270 789-1 (6x) +276 035-3 +276 052-8 	<b>08-24860-05</b> 276 123-7 	<b>15-76086-01</b>  271 157-0 	<b>61-27190-10</b> 6x 270 789-1 137 Ø 1,4 mm 		<b>15-26296-01</b> 276 035-3 			<b>11-31088-01</b>  276 052-8 	<b>71-24860-10</b> 422 025-7 	<b>81-25952-20 K</b>  424 983-5 85,73x114,33 A SL RD FPM  <b>81-36602-00 K</b>  20 441 697 155x180 AB SL LD FPM 

**VOLVO**

Ltr.



9,6 THD 100 A  
THD 100 D

 <p><b>01-23160-04</b> 275 551-0 (6x) +270 782-6 +270 958-2 +275 533-8</p> 	 <p><b>02-23160-02</b> 275 551-0 (6x) +270 958-2 +275 533-8</p> 	 <p><b>08-25811-02</b> 270 782-6</p> 	 <p><b>15-76807-03</b>  6x 271 158-8</p> 	 <p><b>61-23160-10</b> 6x 275 551-0 130 Ø 1,4 mm</p> 		 <p><b>15-24360-02</b> 275 533-8</p>  <p><b>71-24359-00</b> 6x 423 145-2</p>  <p><b>71-24360-00</b>  6x 423 146-0</p> 		 <p><b>11-24361-03</b>   6x 270 958-2</p> 	 <p><b>71-25811-10</b> 424 127-9</p> 	 <p><b>81-25852-20</b>   424 983-5 85,73x114,33 A SL RD FPM</p>  <p><b>81-36602-00</b>   20 441 897 155x180 AB SL LD FPM</p> 
--	---	--	---	--	--	--	--	---	--	---

**VOLVO**

Ltr.

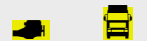

9,6 THD 100 DA  
THD 100 DB  
THD 100 DC  
THD 100 DD

<p><b>01-23160-04</b> 275 551-0 (6x) +270 782-6 +270 958-2 +275 533-8 ➡ 23198</p>	<p><b>02-23160-02</b> 275 551-0 (6x) +270 958-2 +275 533-8 ➡ 23198</p>	<p><b>08-25811-02</b> 270 782-6</p>	<p><b>15-76807-03</b> Ⓢ 271 158-8</p>	<p><b>61-23160-10</b> 6x 275 551-0 130 Ø 1,4 mm</p>		<p><b>15-24360-02</b> 275 533-8 ➡ 23198</p> <p><b>15-26296-02</b> 275 741-7 ➡ 23199→</p> <p><b>71-24359-00</b> 6x 423 145-2 ➡ 23198</p> <p><b>71-24360-00</b> Ⓢ 6x 423 146-0 ➡ 23198</p> <p><b>71-26296-10</b> 6x 424 693 0 ➡ 23199→</p> <p><b>71-26297-10</b> Ⓢ 6x 424 694-8 ➡ 23199→</p>		<p><b>11-24361-03</b> Ⓢ Ⓢ 270 958-2</p>	<p><b>71-25811-10</b> 424 127-9</p>	<p><b>81-25852-20</b> Ⓢ 424 983-5 85,73x114,33 A SL RD FPM</p> <p><b>81-36602-00</b> Ⓢ 20 441 697 155x180 AB SL LD FPM</p>

**VOLVO**

Ltr.



9,6 THD 100 E  
THD 100 EA  
THD 100 EB  
THD 100 EC  
THD 100 ED  
THD 100 EE  
THD 100 EK

		<p><b>02-27190-03</b> 270 789-1 (6x) +275 741-0 +276 052-8</p>	<p><b>08-25811-02</b> 270 782-6</p>	<p><b>15-76807-03</b> </p> <p>271 158-8 6x</p>	<p><b>61-27190-10</b> 6x</p> <p>270 789-1 137 Ø 1,4 mm</p>		<p><b>15-26296-02</b> 275 741-7</p>		<p><b>11-31088-01</b> </p> <p>276 052-8</p>	<p><b>71-25811-10</b> 424 127-9</p>	<p><b>81-25852-20</b> </p> <p>424 983-5 85,73x114,33 A SL RD FPM</p> <p><b>81-36602-00</b> </p> <p>20 441 697 155x180 AB SL LD FPM</p>

9,6 THD 101 B  
THD 101 GB  
THD 101 GC  
THD 101 GD  
THD 101 KB  
THD 101 KC  
THD 101 KE  
THD 102 KB  
THD 102 KD  
THD 102 KF  
THD 102 KJ  
THD 103 E  
THD 103 ES  
THD 103 KB  
THD 103 KD  
THD 103 KF

		<p><b>01-27190-04</b> 270 789-1 (6x) +275 741-0 +275 785-4 +276 052-8</p>	<p><b>02-27190-03</b> 270 789-1 (6x) +275 741-0 +276 052-8</p>	<p><b>08-31517-01</b> 275 785-4</p>	<p><b>15-76086-01</b> </p> <p>271 157-0 6x</p>	<p><b>61-27190-10</b> 6x</p> <p>270 789-1 137 Ø 1,4 mm</p>		<p><b>15-26296-02</b> 275 741-7</p>		<p><b>11-31088-01</b> </p> <p>276 052-8</p>	<p><b>81-25852-20</b> </p> <p>424 983-5 85,73x114,33 A SL RD FPM</p> <p><b>81-36602-00</b> </p> <p>20 441 697 155x180 AB SL LD FPM</p>

VOLVO													
9,6	THD 102 KA THD 102 KE												
		<b>01-27190-04</b> 270 789-1 (6x) +275 741-0 +275 785-4 +276 052-8	<b>02-27190-03</b> 270 789-1 (6x) +275 741-0 +276 052-8	<b>08-31517-01</b> 275 785-4	<b>15-76086-01</b> 271 157-0 6x	<b>61-27190-10</b> 6x 270 789-1 137 Ø 1,4 mm		<b>15-26296-02</b> 275 741-7		<b>11-31088-01</b> 276 052-8		<b>81-25852-20</b> 424 983-5 85,73x114,33 A SL RD FPM	
												<b>81-36602-00</b> 20 441 697 155x180 AB SL LD FPM	
10,8	D11B390 D11B430 D11C330 D11C370 D11C380 D11C410 D11C430 D11C450 D11C460 D11-325 D11-355 D11-365 D11-385 D11-405		<b>02-36435-03</b> 21 413 877	<b>08-39191-01</b> 21 422 745	<b>15-42947-01</b> 85 103 699 6x	<b>61-36435-10</b> 20 495 935 136 Ø 1,25 mm		<b>71-39074-00</b> 20 804 638	<b>12-37804-01</b> 20 864 662 (24x)	<b>71-37843-00</b> 20 850 506	<b>71-39191-00</b> 20 812 484	<b>81-38651-00</b> 21 347 087 136x159 A SL RD PTFE	
				<b>08-42117-01</b> 21 422 748					<b>70-37804-00</b> 20 864 662 24x	<b>71-37892-00</b> 21 482 601 6x	<b>71-42117-00</b> 21 517 690	<b>81-37941-00</b> 8 148 259 150x180 AB SL LD	
10,8	D11K330 D11K370 D11K380 D11K410 D11K430 D11K450 D11K460		<b>02-36435-04</b> 22 499 254	<b>08-42117-02</b> 22 106 469	<b>15-42947-01</b> 85 103 699 6x	<b>61-36435-10</b> 20 495 935 136 Ø 1,25 mm		<b>71-11866-00</b> 21 487 571	<b>12-37804-01</b> 20 864 662 (24x)	<b>71-37843-00</b> 20 850 506	<b>71-39191-00</b> 20 812 484	<b>81-38651-00</b> 21 347 087 136x159 A SL RD PTFE	
									<b>70-37804-00</b> 20 864 662 24x	<b>71-37892-00</b> 21 482 601 6x	<b>71-42117-00</b> 21 517 690	<b>81-37941-00</b> 8 148 259 150x180 AB SL LD	
11,9	TD 122 F TD 122 FR TD 123 E TD 123 ES		<b>01-31085-01</b> 270 949-1 (6x) +270 772-7 +275 554-4 +276 125-2	<b>02-31085-01</b> 270 949-1 (6x) +270 772-7 +275 554-4	<b>08-24875-04</b> 276 125-2	<b>15-76296-06</b> 270980 6x	<b>61-31085-10</b> 6x 270 949-1 147 Ø 1,4 mm	<b>14-32280-01</b> 6x 470 261 (8x)	<b>15-24362-01</b> 275 554-4		<b>11-24362-02</b> 270 772-7	<b>71-24875-10</b> 424 605-4	<b>81-25952-20</b> 424 983-5 85,73x114,33 A SL RD FPM
												<b>71-34392-00</b> 479 484-8	<b>81-36602-00</b> 20 441 697 155x180 AB SL LD FPM
										<b>71-24362-20</b> 6x 424 692-2			

**VOLVO**

Ltr.



12.0 TD 120 A  
TD 120 C  
TD 120 D  
TD 120 E  
TD 120 F  
TD 120 FA  
TD 120 FB  
TD 120 FC  
TD 120 FTQ  
TD 120 GA

<p><b>01-23215-05</b> 275 548-6 (6x) +270 772-7 +275 554-4 +276 124-6</p>	<p><b>02-23215-02</b> 275 548-6 (6x) +270 772-2 +275 554-4</p> <p><b>03-23215-02</b></p>	<p><b>08-24875-03</b> 276 124-6</p>	<p><b>15-76926-05</b>  6x 271 181-0</p>	<p><b>61-23215-10</b> 6x 275 548-6 140 Ø 1,4 mm</p>	<p><b>14-32280-01</b> 6x 470 261 (8x)</p>	<p><b>15-24362-01</b> 6x 275 554-4</p> <p><b>71-24362-20</b> 6x 424 692-2</p>		<p><b>11-24363-02</b>   6x 270 772-7</p>	<p><b>71-24875-10</b> 424 605-4</p>	<p><b>40-75197-00 K</b>  422 146-1 85,7x98,5 Filz  91925</p> <p><b>81-25952-20 K</b>  424 983-5 85,73x114,33 A SL RD FPM  91926-→</p> <p><b>40-75198-00 K</b>  422 145-3 155x168 Filz  13193</p> <p><b>81-36602-00 K</b>  20 441 697 155x180 AB SL LD FPM  13194-→</p>



**VOLVO**

Ltr.

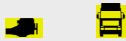

12.0 TD 120 G

<p><b>01-23215-05</b> 275 548-6 (6x) +270 772-7 +275 554-4 +276 124-6</p>	<p><b>02-23215-02</b> 275 548-6 (6x) +270 772-2 +275 554-4</p> <p><b>03-23215-02</b></p>	<p><b>08-24875-03</b> 276 124-6</p>	<p><b>15-76926-03</b> ③ 6x 271 156-2</p> <p><b>15-76926-05</b> ③ 6x 271 181-0</p>	<p><b>61-23215-10</b> 6x 275 548-6 140 Ø 1,4 mm</p>	<p><b>14-32280-01</b> 6x 470 261 (8x)</p>	<p><b>15-24362-01</b> 275 554-4</p> <p><b>71-24362-20</b> 6x 424 692-2</p>		<p><b>11-24363-02</b> ④ ⑤ 270 772-7</p>	<p><b>71-24875-10</b> 424 605-4</p>	<p><b>40-75197-00</b> K↔ 422 146-1 85,7x98,5 Filz ↔ 91925</p> <p><b>81-25952-20</b> K↔ 424 983-5 85,73x114,33 A SL RD FPM ↔ 91926→</p> <p><b>40-75198-00</b> K↔ 422 145-3 155x168 Filz ↔ 13193</p> <p><b>81-36602-00</b> K↔ 20 441 697 155x180 AB SL LD FPM ↔ 13194→</p>

12.0

TD 121 F  
TD 121 FA  
TD 121 FB  
TD 121 FC  
TD 121 FD  
TD 121 FE  
TD 121 FF  
TD 121 FG  
TD 121 FH  
TD 121 FK  
TD 121 G  
TD 121 GD

<p><b>01-23215-05</b> 275 548-6 (6x) +270 772-7 +275 554-4 +276 124-6</p>	<p><b>02-23215-02</b> 275 548-6 (6x) +270 772-2 +275 554-4</p>	<p><b>08-24875-03</b> 276 124-6</p>	<p><b>15-76926-04</b> ④ 6x 271 155-4 ↔ 131995</p> <p><b>15-76926-06</b> ③ 6x 270950 ↔ 131996→</p>	<p><b>61-23215-10</b> 6x 275 548-6 140 Ø 1,4 mm</p>	<p><b>14-32280-01</b> 6x 470 261 (8x)</p>	<p><b>15-24362-01</b> 275 554-4</p> <p><b>71-24362-20</b> 6x 424 692-2</p>		<p><b>11-24363-02</b> ④ ⑤ 270 772-7</p>	<p><b>71-24875-10</b> 424 605-4</p>	<p><b>40-75197-00</b> K↔ 422 146-1 85,7x98,5 Filz ↔ 91925</p> <p><b>81-25952-20</b> K↔ 424 983-5 85,73x114,33 A SL RD FPM ↔ 91926→</p> <p><b>81-36602-00</b> K↔ 20 441 697 155x180 AB SL LD FPM</p>
---	--	---	---	---	---	--	--	---	---	---

VOLVO												
Ltr.												
12.0	TD 122 F TD 122 FA TD 122 FAQ TD 122 FBQ TD 122 FCQ TD 122 FH TD 122 FK TD 122 FL TD 122 FR TD 122 FS TD 123 EA TD 123 EB TD 123 EC TD 123 ED TD 123 ES	<b>01-31085-01</b> 270 949-1 (6x) +270 772-7 +275 554-4 +276 125-2 	<b>02-31085-01</b> 270 949-1 (6x) +270 772-7 +275 554-4 	<b>08-24875-04</b> 276 125-2 	<b>15-76926-06</b> 270950 	<b>61-31085-10</b> 6x 270 949-1 147 Ø 1,4 mm 	<b>14-32280-01</b> 6x 470 261 (6x) 	<b>15-24362-01</b> 6x 275 554-4  <b>71-24362-20</b> 6x 424 692-2 	<b>11-24363-02</b> 270 772-7 	<b>71-24875-10</b> 424 605-4  <b>71-34392-00</b> 479 484-8 	<b>81-25852-20</b> 424 983-5 85,73x114,33 A SL RD FPM  <b>81-36602-00</b> 20 441 697 155x180 AB SL LD FPM 	
12.0	TD 122 FL	<b>01-31085-01</b> 270 949-1 (6x) +270 772-7 +275 554-4 +276 125-2 	<b>02-31085-01</b> 270 949-1 (6x) +270 772-7 +275 554-4 	<b>08-24875-04</b> 276 125-2 	<b>15-76926-06</b> 270950 	<b>61-31085-10</b> 6x 270 949-1 147 Ø 1,4 mm 	<b>14-32280-01</b> 6x 470 261 (6x) 	<b>15-24362-01</b> 6x 275 554-4  <b>71-24362-20</b> 6x 424 692-2 	<b>11-24363-02</b> 270 772-7 	<b>71-24875-10</b> 424 605-4  <b>71-34392-00</b> 479 484-8  <b>71-34392-00</b> 479 484-8 	<b>81-25952-20</b> 424 983-5 85,73x114,33 A SL RD FPM  <b>81-36602-00</b> 20 441 697 155x180 AB SL LD FPM 	
12.1	DH12D340 DH12D380 DH12D420	<b>02-36260-01</b> 20 710 242 +3 093 504 +3 099 100 	<b>08-10006-01</b> 85 104 225 	<b>61-36260-10</b> 3 099 100 147 Ø 1,25 mm 	<b>15-36526-01</b> 85 112 559  <b>71-36526-00</b> 8 170 116 	<b>12-34914-03</b> 20 459 855 (24x)  <b>70-34914-00</b> 859 171 	<b>11-33889-02</b> 3 093 504 	<b>10-10995-01</b> 85 104 152 	<b>81-38651-00</b> 21 347 087 136x159 A SL RD PTFE  <b>81-35206-10</b> 85 108 352 180x205 A SL PTFE (Polytetrafluorethylen)/FPM (Fluor-Kautschuk) 			

**VOLVO**

Ltr.

12,1



DH12E340  
DH12E380  
DH12E420  
DH12E460

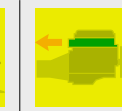

**02-36260-01**  
20 710 242  
+3 093 504  
+3 099 100



**08-10006-01**  
85 104 225



**61-36260-10**  
3 099 100  
147 Ø  
1,25 mm

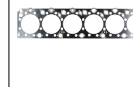

**15-36526-01**  
85 112 559

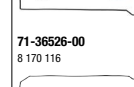

**71-36526-00**  
8 170 116



**12-34914-03**  
20 459 855 (24x)

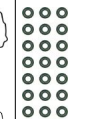

**70-34914-00**  
859 171

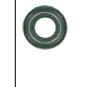

**11-33889-02**

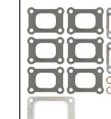

**71-33889-00**

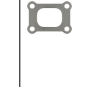

**10-10995-01**  
85 104 152

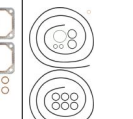

**81-38651-00**

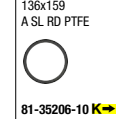

**81-35206-10**



12,1

D12A340  
D12A380  
D12A420

**01-29095-01**

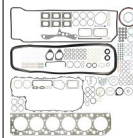

**02-29095-01**  
276 875  
+276 930

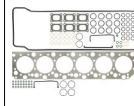

**08-35936-03**  
276 888

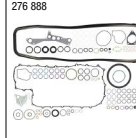

**15-76926-06**

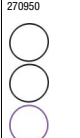

**61-29095-10**  
3 093 503  
147 Ø  
1,25 mm

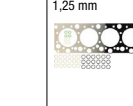

**15-34868-01**

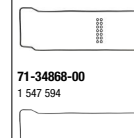

**71-34868-00**  
1 547 594



**12-34914-03**  
20 459 855 (24x)

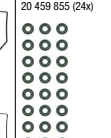

**70-34914-00**  
859 171



**11-33889-01**

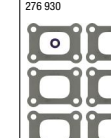

**71-35936-00**



**71-42299-00**

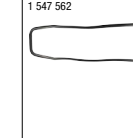

**81-42299-00**

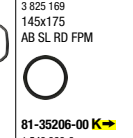

**81-35206-00**



12,1

D12C340  
D12C380  
D12C390  
D12C420  
D12C460

**01-36260-01**

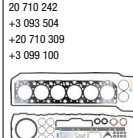

**02-36260-01**  
20 710 242  
+3 093 504  
+20 710 309  
+3 099 100



**08-35936-02**  
20 710 309

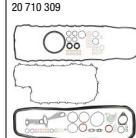

**15-76926-06**

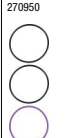

**61-36260-10**  
3 099 100  
147 Ø  
1,25 mm

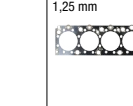

**15-36526-01**  
85 112 559

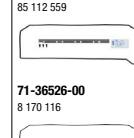

**71-36526-00**  
8 170 116



**12-34914-03**  
20 459 855 (24x)

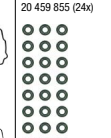

**70-34914-00**  
859 171



**11-33889-02**

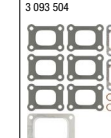

**71-37749-00**

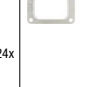

**71-35936-00**

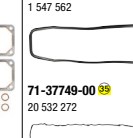

**81-42299-00**

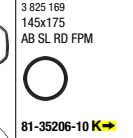

**81-35206-10**



12,1

D12D340  
D12D365  
D12D380  
D12D390  
D12D395  
D12D420  
D12D425  
D12D435  
D12D460  
D12D465

**01-36260-01**

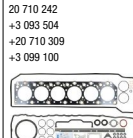

**02-36260-01**  
20 710 242  
+3 093 504  
+20 710 309  
+3 099 100



**08-35936-02**  
20 710 309

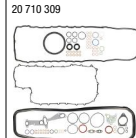

**15-76926-06**

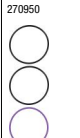

**61-36260-10**  
3 099 100  
147 Ø  
1,25 mm

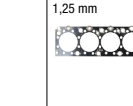

**15-36526-01**  
85 112 559

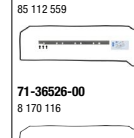

**71-36526-00**  
8 170 116



**12-34914-03**  
20 459 855 (24x)

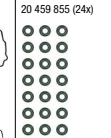

**70-34914-00**  
859 171

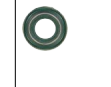

**11-33889-02**

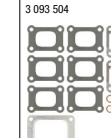

**71-37749-00**

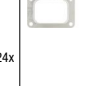

**71-35936-00**

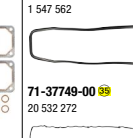

**81-35206-10**

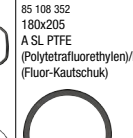

**81-35206-10**



**VOLVO**

Ltr.

12,1 D12D500



<p><b>01-36260-01</b> 20 710 242 +3 093 504 +20 710 309 +3 099 100</p>	<p><b>02-36260-01</b> 20 710 242 +3 093 504 +3 099 100</p>		<p><b>15-76926-06</b>  6x 270950</p>	<p><b>61-36260-10</b> 3 099 100 147 Ø 1,25 mm</p>		<p><b>15-36526-01</b> 85 112 559</p> <p><b>71-36526-00</b> 8 170 116</p>	<p><b>12-34914-03</b> 20 459 855 (24x)</p> <p><b>70-34914-00</b> 859 171</p> <p>24x</p>	<p><b>11-33889-02</b>  3 093 504</p>	<p><b>71-35936-00</b>  1 547 562</p> <p><b>71-37749-00</b>  20 532 272</p>	<p><b>81-35206-10</b> </p> <p>85 108 352 180x205 A SL PTFE (Polytetrafluorethylen)/FPM (Fluor-Kautschuk)</p>
--	--	--	--	---	--	--	---	--	--	--

12,8

D13A360  
D13A380  
D13A400  
D13A420  
D13A440  
D13A460  
D13A480  
D13A500  
D13A520  
D13B360  
D13B400  
D13B440  
D13B500  
D13C380  
D13C420  
D13C440  
D13C460  
D13C480  
D13C500  
D13C520  
D13C540  
D13F335  
D13F375  
D13F405  
D13F425  
D13F435  
D13F485  
D13F515  
D13H375  
D13H405  
D13H425  
D13H435  
D13H440  
D13H455  
D13H475  
D13H500  
D13J375  
D13J405  
D13J425  
D13J435  
D13J455  
D13J475  
D13J500  
D13M375  
D13M405  
D13M425  
D13M435  
D13M455  
D13M500  
D13400  
D13435  
D13465  
D13500

<p><b>01-36855-01</b> 21 539 731 +21 545 620</p>	<p><b>02-36855-02</b> 21 768 034</p>	<p><b>08-37751-02</b> 21 545 620</p>		<p><b>61-36855-10</b> 21 510 072 147 Ø</p>		<p><b>71-37703-00</b> 20 538 793</p>	<p><b>12-37804-01</b> 20 864 662 (24x)</p> <p><b>70-37804-00</b> 20 864 662</p> <p>24x</p>	<p><b>71-37846-00</b>  20 805 850</p> <p><b>71-37894-10</b>   6x 20 855 371</p>	<p><b>71-37751-00</b>  20 541 940</p> <p><b>71-39192-10</b>  21 293 367</p>	<p><b>81-38651-00</b> </p> <p>21 347 087 136x159 A SL RD PTFE</p> <p><b>81-35206-10</b> </p> <p>85 108 352 180x205 A SL PTFE (Polytetrafluorethylen)/FPM (Fluor-Kautschuk)</p>
--	--	--	--	--	--	--	--	---	---	--













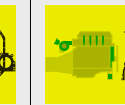
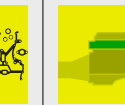
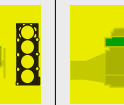

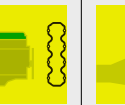
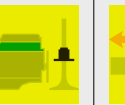
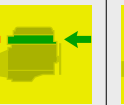

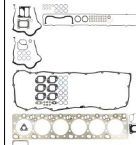
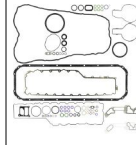
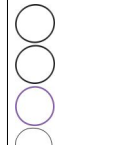
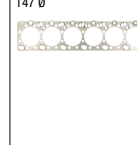
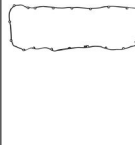
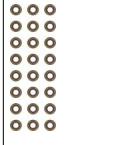

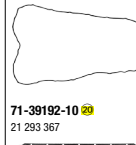
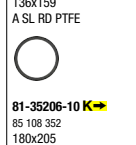

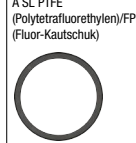

**VOLVO**

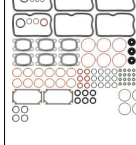
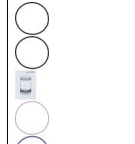
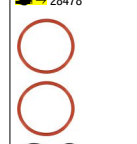
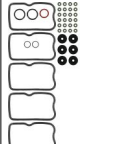
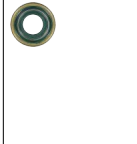
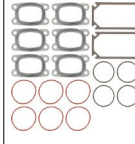
Ltr.

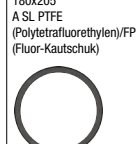
- D13K420
- D13K420S
- D13K440
- D13K460
- D13K460S
- D13K460T
- D13K480
- D13K500
- D13K500S
- D13K500T
- D13K520
- D13K540
- D13K540S

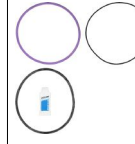
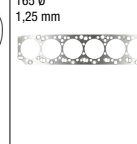
16,0 D 16A

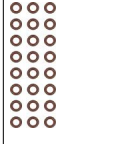
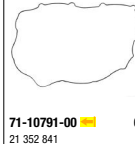
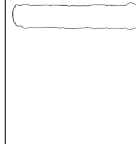
16,0 D16G700  
D16G750

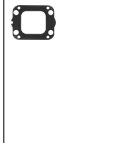
											
12,8	<p><b>02-36855-03</b> 22 164 943</p> 	<p><b>08-37751-02</b> 21 545 620</p> 	<p><b>15-76926-06</b> ③ 6x 270950</p> 	<p><b>61-36855-10</b> 21 510 072 147 Ø</p> 		<p><b>71-13208-00</b> 22 777 560</p> 	<p><b>12-37804-01</b> 20 864 662 (24x)</p> 	<p><b>71-37846-00</b> ① 6x 20 805 850</p> 	<p><b>71-37751-00</b> ② ③ 20 541 940</p> 	<p><b>81-38651-00</b> K↔ 21 347 087 136x159 A SL PTFE</p> 	
							<p><b>70-37804-00</b> 20 864 662</p> 	<p><b>71-37894-10</b> ④ 6x 20 855 371</p> 	<p><b>71-39192-10</b> ⑤ 21 293 367</p> 	<p><b>81-35206-10</b> K↔ 85 108 352 180x205 A SL PTFE (Polytetrafluorethylen)/FPM (Fluor-Kautschuk)</p> 	
16,0	<p><b>01-34120-01</b> 276 924 (6x) +276 947 +3 095 201 +3 095 202</p> 	<p><b>02-34120-01</b> 276 924 (6x) +276 947 +3 095 201</p> 		<p><b>15-76818-01</b> ③ 6x 270 935</p> 	<p><b>61-34120-00</b> 6x 276 924 ➡ 28478</p> 		<p><b>15-33712-01</b> 3 095 201</p> 	<p><b>70-34944-00</b> 24x 1 556 064</p> 	<p><b>11-33891-01</b> ① ② ③ 6x 276 917</p> 	<p><b>71-35937-00</b> 1 556 387 ➡ 6618→</p> 	<p><b>81-35206-10</b> K↔ 85 108 352 180x205 A SL PTFE (Polytetrafluorethylen)/FPM (Fluor-Kautschuk)</p> 
							<p><b>71-33891-00</b> 6x 8 130 038</p> 				
16,0				<p><b>15-10805-01</b> ③ 6x 20 520 607</p> 	<p><b>61-10831-00</b> 21 575 727 165 Ø 1,25 mm</p> 		<p><b>71-10789-00</b> 20 736 230</p> 	<p><b>12-10792-01</b> 20 924 435 (24x)</p> 	<p><b>71-18852-00</b> ① 6x 20 563 945</p> 	<p><b>71-10796-00</b> 20 734 156</p> 	
							<p><b>70-10792-00</b> 24x 20 924 435</p> 	<p><b>71-10791-00</b> ② 6x 21 352 841</p> 			

**VOLVO**

Ltr.

- D16A470
- D16A520
- D16B520
- TD 162 F
- TD 162 FJ
- TD 162 FL
- TD 162 FS
- TD 163 ES



<p>16,1</p>	<p><b>01-34120-01</b> 276 924 (6x) +276 947 +3 095 201 +3 095 202</p>	<p><b>02-34120-01</b> 276 924 (6x) +276 947 +3 095 201</p>	<p><b>08-35937-01</b> 3 095 202</p>	<p><b>15-76818-01</b> ⑤ 270 935</p>	<p><b>61-34120-00</b> 6x 276 924 ➡ 28478</p> <p><b>61-34120-10</b> ⑤ 6x ➡ 28479➔</p>		<p><b>15-33712-01</b> 3 095 201</p>	<p><b>12-34944-01</b> 1 556 064 (24x)</p> <p><b>70-34944-00</b> 24x 1 556 064</p> <p><b>71-33712-00</b> 6x 1 543 581-1</p>	<p><b>11-33891-01</b> ⑤ 276 917</p> <p><b>71-33891-00</b> ⑤ 6x 8 130 038</p>	<p><b>71-40321-00</b> ⑤ 1 543 599 ➡ 6617</p> <p><b>71-35937-00</b> 1 556 387 ➡ 6618➔</p>	<p><b>81-38651-00</b> K↔ 21 347 087 136x159 A SL RD PTFE</p> <p><b>81-35206-10</b> K↔ 85 108 352 180x205 A SL PTFE (Polytetrafluorethylen)/FPM (Fluor-Kautschuk)</p>
-------------	---	--	---	---	--	--	---	--	--	--	--

<p>16,1</p> <p>D16C550 D16C610</p>		<p><b>02-10789-01</b> 85 107 729</p>	<p><b>08-10796-01</b> 85 107 769</p>	<p><b>15-10805-01</b> ⑤ 6x 20 520 607</p>	<p><b>61-37975-00</b> 21 431 327 166 Ø 1,25 mm</p>		<p><b>71-10789-00</b> 20 736 230</p>	<p><b>12-10792-01</b> 20 924 435 (24x)</p> <p><b>70-10792-00</b> 24x 20 924 435</p>	<p><b>71-10790-00</b> ⑤ 20 479 613</p> <p><b>71-10791-00</b> ⑤ 6x 21 352 841</p>	<p><b>71-10796-00</b> 20 734 156</p>	<p><b>81-38651-00</b> K↔ 21 347 087 136x159 A SL RD PTFE</p> <p><b>81-35206-10</b> K↔ 85 108 352 180x205 A SL PTFE (Polytetrafluorethylen)/FPM (Fluor-Kautschuk)</p>
--	--	--	--	---	--	--	--	---	--	--	--

<p>16,1</p> <p>D16E540 D16E580 D16E660 D16G540 D16G600 D16G700 D16G750 D16K550 D16K650 D16K750</p>				<p><b>15-10805-01</b> ⑤ 6x 20 520 607</p>	<p><b>61-10831-00</b> 21 575 727 165 Ø 1,25 mm</p>		<p><b>71-10789-00</b> 20 736 230</p>	<p><b>12-10792-01</b> 20 924 435 (24x)</p> <p><b>70-10792-00</b> 24x 20 924 435</p>	<p><b>71-18852-00</b> ⑤ 20 563 945</p> <p><b>71-10791-00</b> ⑤ 6x 21 352 841</p>	<p><b>71-10796-00</b> 20 734 156</p>	
--	--	--	--	---	--	--	--	---	--	--	--

# Haftungsausschluss

## (für Katalog)

**Alle Angaben in unserem Katalog** wurden von uns sorgfältig geprüft, sind jedoch unverbindlich. Ersatzansprüche wegen Katalogangaben werden von uns nicht anerkannt. Der Käufer ist selbst verpflichtet, zu prüfen, ob unsere Teile für seine Zwecke geeignet sind. In allen Zweifelsfällen sollte Rücksprache mit unserem technischen Kundendienst erfolgen **Tel. +49 731 7046 999**.

**Technische Weiterentwicklungen** oder Änderungen bleiben vorbehalten, soweit damit keine Nachteile für den Kunden verbunden sind.

**Angaben, Namens- und Markenzeichen**, Beschreibungen, Nummern von Fahrzeugnummern und Herstellerzeichen, Original-Ersatzteilnummern der Fahrzeug- und Motorenhersteller u. a. sind ausschließlich für interne Zwecke gedacht. Solche Kennzeichnungen dürfen Fahrzeugbesitzern gegenüber nicht verwendet werden.

**Wir weisen ausdrücklich darauf hin**, dass alle von uns gelieferten Teile von geschultem Fachpersonal einzubauen sind. Reinz haftet für Fehler in diesem Katalog nur, wenn diese für den Kunden nicht offenbar erkennbar sind sowie nur bei Vorsatz und grober Fahrlässigkeit von Reinz, eines Vertreters oder eines Erfüllungsgehilfen. Dieser Haftungsausschluss gilt nicht im Rahmen

des Anwendungsbereichs des Produkthaftungsgesetzes und nicht bei Verletzung von Körper, Leben und Gesundheit, sowie bei der Verletzung von sog. Kardinalpflichten. Darüber hinaus ist unsere Haftung für Schäden, insbesondere für Personen-, Sach- oder Vermögensschäden, die unmittelbar oder mittelbar im Zusammenhang mit der Nutzung dieses Kataloges auftreten, sowie für nicht voraussehbare Schäden ausgeschlossen.

**Reinz ist Inhaber aller Schutzrechte** an den in diesem Katalog gespeicherten Daten. Kopie, Nachdruck, ganze oder teilweise Übernahme der Inhalte und Vervielfältigung, auch auszugsweise, ist nur mit unserer vorheriger schriftlicher Zustimmung sowie mit unserem Urheberrechtsvermerk zulässig.

Für Bestellungen, welche ab dem Erscheinungsdatum eines neuen Katalogs getätigt werden, sind alleine die Angaben des neuen Katalogs maßgeblich. Auf Angaben im Vorkatalog kann bei Neubestellungen nicht mehr zurückgegriffen werden.

**Sofern Sie noch Fragen haben, bitten wir Sie, sich mit uns in Verbindung zu setzen.**

[VictorReinz.com/AGB](http://VictorReinz.com/AGB)

# Exclusion of Liability

## (for catalog)

**All details in our catalog** have been thoroughly checked by us but are however not binding. Right to damages on account of catalog details will not be recognized. The purchaser is obliged to check if our parts are suitable for their use. In all doubtful cases, the purchaser should consult our technical customer service under **+49 731 7046 999**.

**We reserve the right** to further technical developments or changes as long as no disadvantage for the customer results.

**Details, name and trademarks**, descriptions, numbers from vehicle numbers and manufacturer symbols, original vehicle replacement part numbers and engine manufacturer etc. are solely for internal use. Such labels must not be used with vehicle owners.

**We specifically point out** that all parts supplied by us must be assembled by trained specialists.

**Reinz is liable for mistakes** in this catalog only when they are not clearly recognizable for the customer, as well as by intent or gross negligence on the part of Reinz, its representative or vicarious agent. This exclusion of liability does not apply within the framework of the field of

application of the product liability laws and not by bodily harm, life and health, as well as by violation of cardinal duties. In addition, our liability for damages, especially personal, property or financial damages that occur directly or indirectly as a result of the use of this catalog, as well as non-foreseeable damages are excluded.

**Reinz is the owner of all patent rights** on the data stored in this catalog. Copies, reprints, whole or partial takeover of the contents and duplication even in excerpts are only permissible with our prior written approval, as well as with our copyright note.

**For orders placed after the publication date** of a new catalog, only the details in the new catalog are binding and no fall back to details in the previous catalog is possible.

**In case you have further questions, do not hesitate to contact us.**

[VictorReinz.com/AGB](http://VictorReinz.com/AGB)

**VictorReinz.com**

**reinz.info@dana.com**

**Technical Hotline +49 (0)731 7046-9 99**

**REINZ-Dichtungs-GmbH**

Reinzstrasse 3-7  
89233 Neu-Ulm  
Germany  
+49 (0)731 7046-0

***VICTOR REINZ***<sup>®</sup>

---

