

**VICTOR REINZ®**

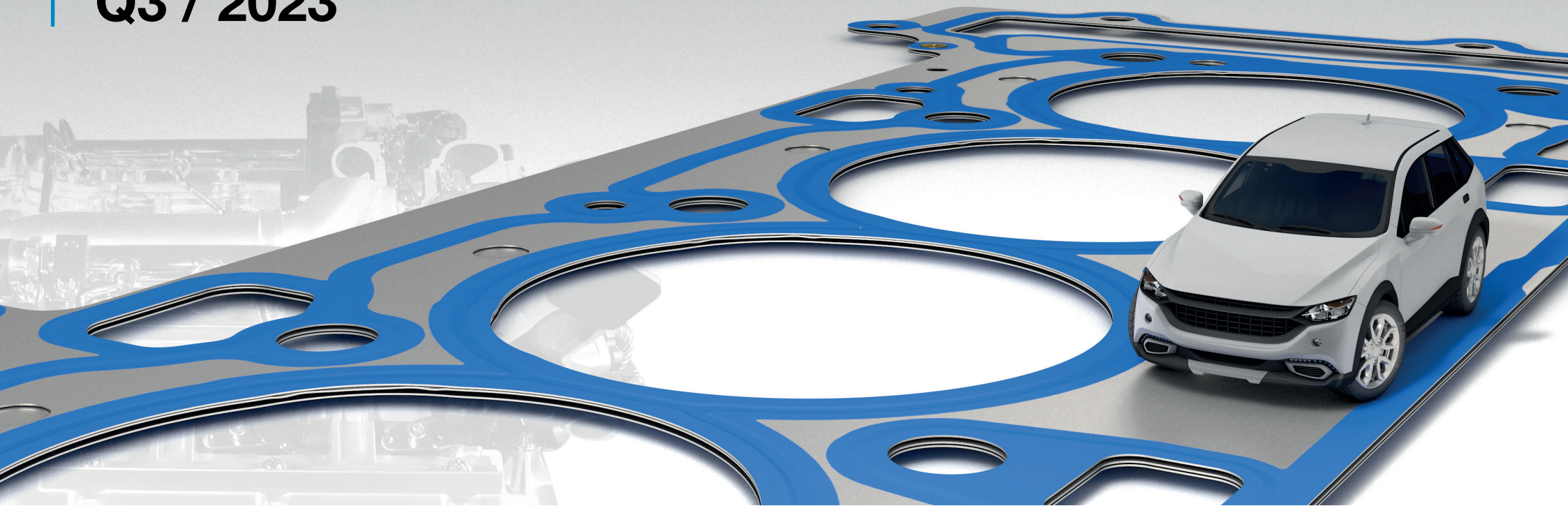

**AUSTIN**  
**Q3 / 2023**



**[VictorReinz.com/online-catalog](https://VictorReinz.com/online-catalog)**

# Victor Reinz®

at a Glance



## Online Catalog

[VictorReinz.com/online-catalog](https://VictorReinz.com/online-catalog)



## Newsletter

[VictorReinz.com/EN/News/Newsletter.aspx?region](https://VictorReinz.com/EN/News/Newsletter.aspx?region)



## Youtube

[www.youtube.com/user/VictorReinzSealingEN](https://www.youtube.com/user/VictorReinzSealingEN)



## Catalog News

[VictorReinz.com/news](https://VictorReinz.com/news)



## Technical Service Information

[VictorReinz.com/tsi](https://VictorReinz.com/tsi)



## Facebook

[www.facebook.com/VictorReinzParts](https://www.facebook.com/VictorReinzParts)



## Just seal it!

[VictorReinz.com/jsi](https://VictorReinz.com/jsi)



## Technical Datasheet

[VictorReinz.com/jsi-datasheet](https://VictorReinz.com/jsi-datasheet)



## LinkedIn

[www.linkedin.com/showcase/victor-reinz-emea](https://www.linkedin.com/showcase/victor-reinz-emea)



## Safety Datasheet

[VictorReinz.com/jsi-datasheet](https://VictorReinz.com/jsi-datasheet)



## Homepage

[VictorReinz.com](https://VictorReinz.com)

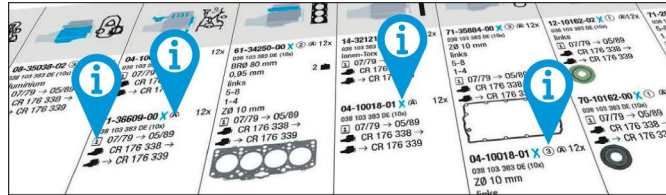

[VictorReinz.com/catalog-info](https://www.victorreinz.com/catalog-info)

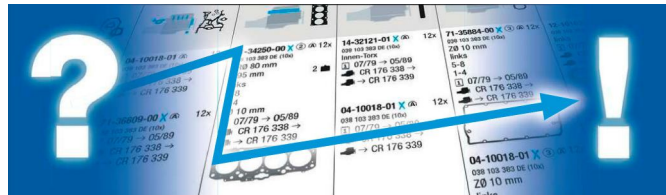

[VictorReinz.com/catalog-how-to-use](https://www.victorreinz.com/catalog-how-to-use)

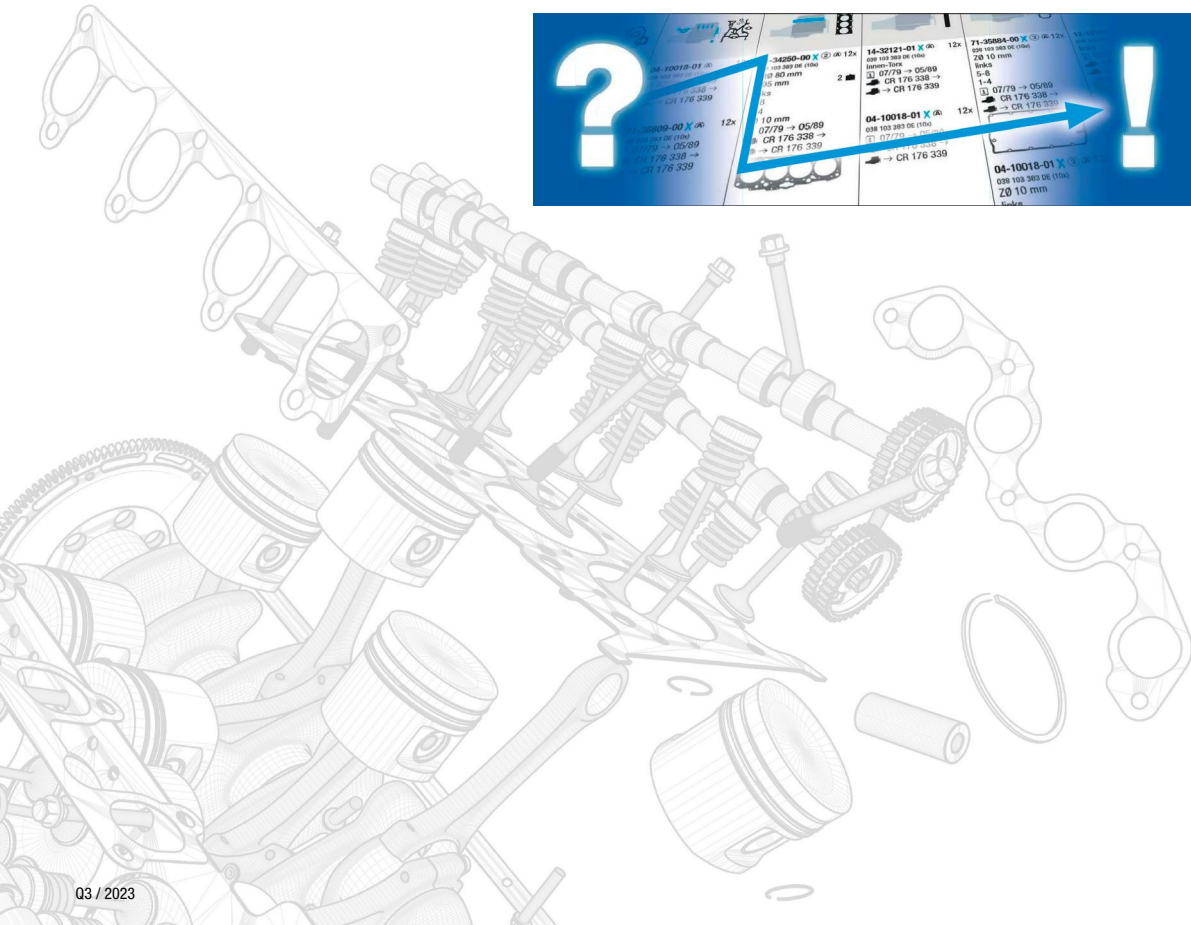























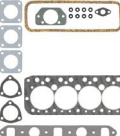































# AUSTIN



<b>0-9</b>	
12 H	5
12 H996AA	5
16 HA35AL	5
16 HC37	5
18 H	6
99 H	5

AUSTIN

<p>Ltr.  1,0 99 H</p>	<p>29-33 kW (39-45 PS)</p>	<p>ALLEGRO METRO MINI</p>	<p> 10/67-04/90</p>	   	<p>61-35330-00 AJM302 67,8 Ø</p> 	<p>71-35424-00 AJM401</p> 	<p>71-35422-00  </p> 	<p>10-35423-01</p> 	<p>81-53261-00  </p> <p>38x59 A SL RD NBR</p> 	
<p>1,3 12 H</p>	<p>40-49 kW (54-67 PS)</p>	<p>ALLEGRO MAESTRO METRO MINI</p>	<p>05/73-09/92</p>	<p>02-35335-01 BHM1391</p> 	<p>61-35335-00 GEG301 74 Ø</p> 	<p>71-35424-00 AJM401</p> 	<p>12-35421-01 ADU905 (8x)</p> 	<p>71-35422-00  </p> 	<p>10-35423-01</p> 	
<p>1,3 12 H996AA</p>	<p>52 kW (71 PS)</p>	<p>METRO</p>	<p>10/80-12/85</p>		<p>61-35330-00 AJM302 67,8 Ø</p> 	<p>71-35424-00 AJM401</p> 		<p>71-35422-00  </p> 	<p>10-35423-01</p> 	<p>81-53261-00  </p> <p>38x59 A SL RD NBR</p> 
<p>1,6 16 HA35AL</p>	<p>73 kW (99 PS)</p>	<p>MAESTRO</p>	<p>03/83-08/90</p>	<p>01-35340-01</p>	<p>02-35340-01 BHM1512</p> 		<p>71-35431-00 AJM4498</p> 	<p>71-35428-00  </p> 	<p>71-35429-00 UAM3333</p> 	<p>81-35437-00  </p> <p>RTC5307 88,9x105</p> 
<p>1,6 16 HC37</p>	<p>61 kW (83 PS)</p>	<p>MAESTRO MONTEGO</p>	<p>03/83-08/90</p>	<p>01-35340-02  01/86 →  AK106314</p>			<p>15-35433-01 AJM4499</p>	<p>71-35428-00  </p> 	<p>71-35429-00 UAM3333</p> 	<p>81-15512-50  </p> <p>30x40 A SL RD FPM</p> 
									<p>81-35437-00  </p> <p>RTC5307 88,9x105</p> 	<p>81-35438-00 <b>N</b></p> <p>UAM1636 40x52</p> 
									<p>81-15512-50 <b>N</b></p> <p>UAM1636 40x52</p> 	<p>2x</p>

AUSTIN

Ltr.  1,8 18 H

60 kW (82 PS)

 PRINCESS

 1

04/76-09/78



**81-53261-00**   
 38x59  
 A SL RD NBR



**81-35437-00**   
 R1CS307  
 88,9x105



# Haftungsausschluss

## (für Katalog)

**Alle Angaben in unserem Katalog** wurden von uns sorgfältig geprüft, sind jedoch unverbindlich. Ersatzansprüche wegen Katalogangaben werden von uns nicht anerkannt. Der Käufer ist selbst verpflichtet, zu prüfen, ob unsere Teile für seine Zwecke geeignet sind. In allen Zweifelsfällen sollte Rücksprache mit unserem technischen Kundendienst erfolgen **Tel. +49 731 7046 999**.

**Technische Weiterentwicklungen** oder Änderungen bleiben vorbehalten, soweit damit keine Nachteile für den Kunden verbunden sind.

**Angaben, Namens- und Markenzeichen**, Beschreibungen, Nummern von Fahrzeugnummern und Herstellerzeichen, Original-Ersatzteilnummern der Fahrzeug- und Motorenhersteller u. a. sind ausschließlich für interne Zwecke gedacht. Solche Kennzeichnungen dürfen Fahrzeugbesitzern gegenüber nicht verwendet werden.

**Wir weisen ausdrücklich darauf hin**, dass alle von uns gelieferten Teile von geschultem Fachpersonal einzubauen sind. Reinz haftet für Fehler in diesem Katalog nur, wenn diese für den Kunden nicht offenbar erkennbar sind sowie nur bei Vorsatz und grober Fahrlässigkeit von Reinz, eines Vertreters oder eines Erfüllungsgehilfen. Dieser Haftungsausschluss gilt nicht im Rahmen

des Anwendungsbereichs des Produkthaftungsgesetzes und nicht bei Verletzung von Körper, Leben und Gesundheit, sowie bei der Verletzung von sog. Kardinalpflichten. Darüber hinaus ist unsere Haftung für Schäden, insbesondere für Personen-, Sach- oder Vermögensschäden, die unmittelbar oder mittelbar im Zusammenhang mit der Nutzung dieses Kataloges auftreten, sowie für nicht voraussehbare Schäden ausgeschlossen.

**Reinz ist Inhaber aller Schutzrechte** an den in diesem Katalog gespeicherten Daten. Kopie, Nachdruck, ganze oder teilweise Übernahme der Inhalte und Vervielfältigung, auch auszugsweise, ist nur mit unserer vorheriger schriftlicher Zustimmung sowie mit unserem Urheberrechtsvermerk zulässig.

Für Bestellungen, welche ab dem Erscheinungsdatum eines neuen Katalogs getätigt werden, sind alleine die Angaben des neuen Katalogs maßgeblich. Auf Angaben im Vorkatalog kann bei Neubestellungen nicht mehr zurückgegriffen werden.

**Sofern Sie noch Fragen haben, bitten wir Sie, sich mit uns in Verbindung zu setzen.**

VictorReinz.com/AGB

# Exclusion of Liability

## (for catalog)

**All details in our catalog** have been thoroughly checked by us but are however not binding. Right to damages on account of catalog details will not be recognized. The purchaser is obliged to check if our parts are suitable for their use. In all doubtful cases, the purchaser should consult our technical customer service under **+49 731 7046 999**.

**We reserve the right** to further technical developments or changes as long as no disadvantage for the customer results.

**Details, name and trademarks**, descriptions, numbers from vehicle numbers and manufacturer symbols, original vehicle replacement part numbers and engine manufacturer etc. are solely for internal use. Such labels must not be used with vehicle owners.

**We specifically point out** that all parts supplied by us must be assembled by trained specialists.

**Reinz is liable for mistakes** in this catalog only when they are not clearly recognizable for the customer, as well as by intent or gross negligence on the part of Reinz, its representative or vicarious agent. This exclusion of liability does not apply within the framework of the field of

application of the product liability laws and not by bodily harm, life and health, as well as by violation of cardinal duties. In addition, our liability for damages, especially personal, property or financial damages that occur directly or indirectly as a result of the use of this catalog, as well as non-foreseeable damages are excluded.

**Reinz is the owner of all patent rights** on the data stored in this catalog. Copies, reprints, whole or partial takeover of the contents and duplication even in excerpts are only permissible with our prior written approval, as well as with our copyright note.

**For orders placed after the publication date** of a new catalog, only the details in the new catalog are binding and no fall back to details in the previous catalog is possible.

**In case you have further questions, do not hesitate to contact us.**

VictorReinz.com/AGB





**VictorReinz.com**

**reinz.info@dana.com**

**Technical Hotline +49 (0)731 7046-9 99**

**REINZ-Dichtungs-GmbH**

Reinzstrasse 3-7  
89233 Neu-Ulm  
Germany  
+49 (0)731 7046-0

***VICTOR REINZ***<sup>®</sup>

---

