

**VICTOR REINZ®**

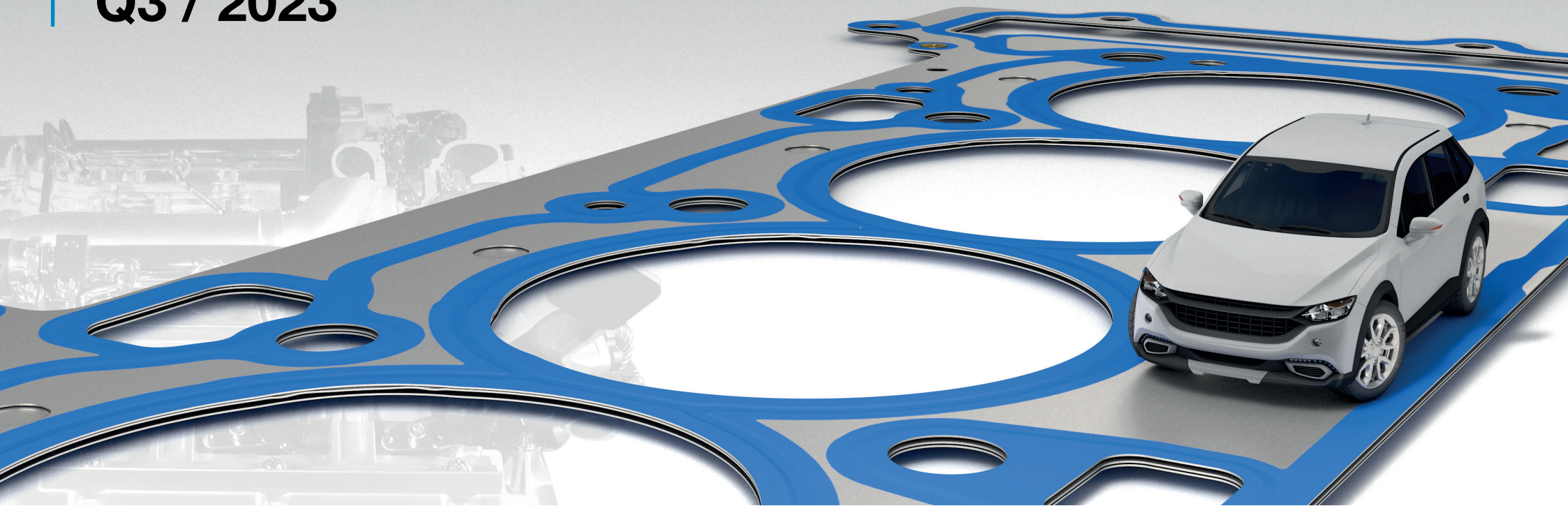

**BMW**  
**Q3 / 2023**



**[VictorReinz.com/online-catalog](https://VictorReinz.com/online-catalog)**

# Victor Reinz®

at a Glance



## Online Catalog

[VictorReinz.com/online-catalog](https://VictorReinz.com/online-catalog)



## Newsletter

[VictorReinz.com/EN/News/Newsletter.aspx?region](https://VictorReinz.com/EN/News/Newsletter.aspx?region)



## Youtube

[www.youtube.com/user/VictorReinzSealingEN](https://www.youtube.com/user/VictorReinzSealingEN)



## Catalog News

[VictorReinz.com/news](https://VictorReinz.com/news)



## Technical Service Information

[VictorReinz.com/tsi](https://VictorReinz.com/tsi)



## Facebook

[www.facebook.com/VictorReinzParts](https://www.facebook.com/VictorReinzParts)



## Just seal it!

[VictorReinz.com/jsi](https://VictorReinz.com/jsi)



## Technical Datasheet

[VictorReinz.com/jsi-datasheet](https://VictorReinz.com/jsi-datasheet)



## LinkedIn

[www.linkedin.com/showcase/victor-reinz-emea](https://www.linkedin.com/showcase/victor-reinz-emea)



## Safety Datasheet

[VictorReinz.com/jsi-datasheet](https://VictorReinz.com/jsi-datasheet)



## Homepage

[VictorReinz.com](https://VictorReinz.com)

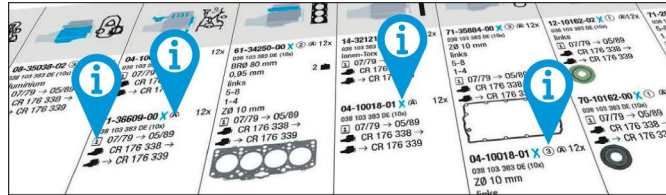

[VictorReinz.com/catalog-info](https://www.victorreinz.com/catalog-info)

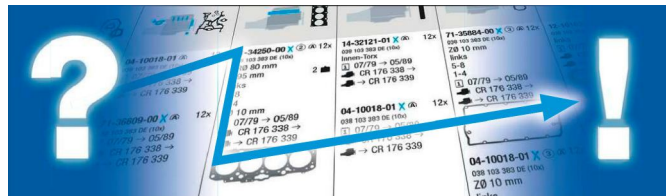

[VictorReinz.com/catalog-how-to-use](https://www.victorreinz.com/catalog-how-to-use)

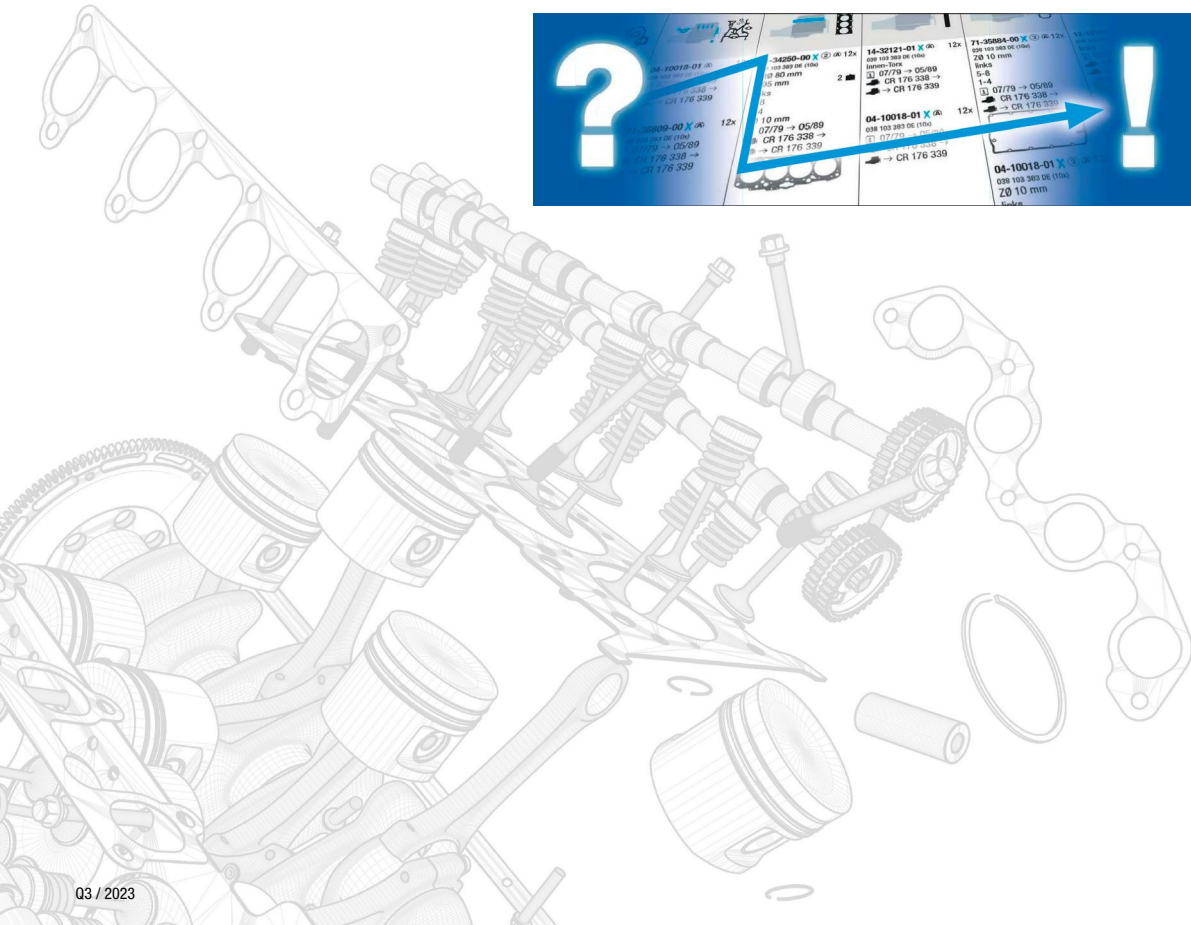

# BMW



**B**

B37 C15 A	5-6
B37 D15 A	6-7
B38 A15 A	7-11
B38 A15 C	11
B38 B15 A	12
B38 K15 A	12
B46 A20 B	31-32
B46 B20 B	32-33
B47 C20 A	34-35
B47 C20 B	34-36
B47 D20 A	34-35, 37
B47 D20 B	34-38
B48 A20 A	31, 39
B48 A20 B	39-40
B48 A20 E	40
B48 A20 F	39
B48 B16 A	13-14
B48 B20 A	32, 41-42
B48 B20 B	32-33, 41-44
B57 D30 A	120-121
B57 D30 B	121-122
B57 D30 C	122
B58 B30 A	123
B58 B30 B	124
B58 B30 C	124-125

**M**

M10 B15	13
M10 B16 (164VA)	16
M10 B16 (164VB)	15
M10 B16 (16A)	14-15
M10 B16 A	14
M10 B18	22
M10 B18 (184EA)	22
M10 B18 (184EB)	22
M10 B18 (184EW)	22
M10 B18 (184EY)	22
M10 B18 (184EZ)	22
M10 B18 (184KA)	22
M10 B18 (184VA)	22
M10 B18 (184VB)	22
M10 B18 (184VC)	22
M10 B18 (184VD)	22
M10 B18 (184VU)	22



M10 B18 (320US)	22
M10 B20	45
M10 B20 (22T A)	45
M10 B20 (22TIU)	46
M10 B20 (23EA)	46
M10 B20 (320EK)	46
M10 B20 (320US)	46
M10 B20 A	45
M118	23
M20 B20	46
M20 B20 (206EA)	46
M20 B20 (206EB)	46
M20 B20 (206EC)	46
M20 B20 (206EE)	46
M20 B20 (206EY)	46
M20 B20 (206EZ)	46
M20 B20 (206KA)	46-47
M20 B20 (206VA)	46
M20 B23 (236EA)	91
M20 B23 (236EB)	91
M20 B23 (236EC)	91
M20 B23 (236EW)	91
M20 B25 (256E1)	94
M20 B25 (256E2)	94
M20 B25 (256EX)	93
M20 B25 (256K1)	94
M20 B27 (276EA)	115
M20 B27 (276EB)	115
M20 B27 (276KA)	115
M20 B27 (276KB)	115
M21 D24 (246DA)	92
M21 D24 (246TA)	92
M21 D24 (246TB)	92
M21 D24 W	93
M30 B25	94
M30 B25 (256EA)	94
M30 B25 (256VA)	94
M30 B25 A	94
M30 B28	115-116
M30 B28 (286EA)	116
M30 B28 (528EL)	115
M30 B28 (528TR)	115
M30 B28 (628EL)	115
M30 B28 (728EL)	115
M30 B28 (728TR)	115



M30 B30	125-127
M30 B30 (306EA)	127
M30 B30 (306KA)	127
M30 B32	184-185
M30 B32 (315/1A)	185
M30 B32 (326TA)	185
M30 B32 (330EL)	184
M30 B32 (633EL)	184
M30 B32 (732EL)	184
M30 B32 (733EL)	184
M30 B33 (35/40 INAT)	187
M30 B34 (346EC)	187-188
M30 B34 (346KA)	187-188
M30 B34 (346KB)	188
M30 B35 (346EC)	190
M30 B35 (356EA)	190
M30 B35 (L-Jetronic,10:1)	189
M30 B35 (Motronic,10:1)	189
M30 B35 (Motronic,9.2:1)	190
M40 B16	16
M40 B16 (164E1)	16
M40 B16 C	16
M40 B18 (184E1)	23-25
M40 B18 C	23
M41 D17 (174T1)	22
M42 B18 (184S1)	25-27
M43 B16 (164E2)	17
M43 B16 (164E3)	18
M43 B18 (184E2)	27-28
M43 B19 (194E1)	29
M44 B19 (194S1)	30
M47 D20 (204D1)	47
M47 D20 (204D4)	48-50
M50 B20 (206S1)	50
M50 B20 (206S2)	51
M50 B25 (256S1)	95
M50 B25 (256S2)	95-96
M51 D25 (256T1)	97-100
M52 B20 (206S3)	51-54
M52 B20 (206S4)	51, 54-55
M52 B25 (256S3)	100-102
M52 B25 (256S4)	100-103
M52 B28 (286S1)	116-119
M52 B28 (286S2)	117-120
M54 B22 (226S1)	90-91



M54 B25 (256S3)	104
M54 B25 (256S5)	104-105
M54 B30 (306S3)	127-128
M57 D25 (256D1)	106
M57 D25 (256D2)	106-107
M57 D30 (306D1)	128-129
M57 D30 (306D2)	129-130
M57 D30 (306D3)	130-133
M57 D30 (306D4)	134
M57 D30 (306D5)	135
M60 B30	135
M60 B30 (308S1)	136
M60 B40 (408S1)	195
M62 B35 (358S1)	191
M62 B35 (358S2)	192
M62 B35 TU	191
M62 B44 (448S1)	197
M62 B44 (448S2)	198-199
M62 B46 (468S1)	208
M67 D39 (398D1)	194
M67 D44 (448D1)	199
M70 B50 (5012A)	210
M70 B56	212
M73 B54	211
M73 B54 (54121)	211
M73 B54 (54122)	211
M88	192
M88 B35 (356ED)	192

**N**

N13 B16 A	18
N20 B16 A	18-19
N20 B20 A	55-57
N20 B20 B	57-58
N20 B20 D	56
N26 B20 A	58
N40 B16 A	19
N42 B18 A	29
N42 B20	58
N42 B20 A	59-60
N42 B20 B	61
N43 B16 A	20
N43 B16 AA	20
N43 B20 A	61
N45 B16	20



N45 B16 A	19-21
N45 B16 AC	21
N45 B16 TU2	20
N45 B20 A	62
N46 B18 A	29
N46 B20 A	62-63
N46 B20 B	61, 63-65
N46 B20 BD	65
N46 B20 C	65-66
N46 B20 CB	66
N46 B20 CC	65
N46 B20 CD	65
N46 B20 E	65
N47	67-68
N47 D16 A	21
N47 D20 A	68-73
N47 D20 B	74
N47 D20 C	68, 74-88
N47 D20 D	74, 88-89
N47N	89
N51 B30 A	136-138
N52 B25	107
N52 B25 A	108-111
N52 B25 AE	112
N52 B25 AF	112-113
N52 B25 B	112-113
N52 B25 BE	112
N52 B25 BF	112-113
N52 B25 C	109
N52 B30	139
N52 B30 A	139-153
N52 B30 AE	153
N52 B30 AF	154
N52 B30 B	154-155
N52 B30 BF	142, 155-156
N53 B25 A	114
N53 B30	156
N53 B30 A	156-164
N54 B30 A	164-169
N54 B30 B	167
N55 B30 A	169-172
N57 306 D2	129
N57 306 D3	181
N57 D30 A	173-177
N57 D30 B	178-180



N57 D30 C	180
N57N 306 D2	182
N57N 306 D3	183
N57N 306 D5	183
N62 B36 A	193
N62 B40 A	195
N62 B44 A	200
N62 B48 A	208-209
N62 B48 B	209-210
N63 B44 A	201-203
N63 B44 B	204-205
N63 B44 C	205
N63 B44 D	205
N73 B60 A	212
N74 B60 A	213
N74 B66 C	213

**S**

S14 204 EA	90
S14 B20 (204EA)	90
S14 B23 (234EA)	91
S14 B23 (234S1)	91
S14 B23 (234S2)	91
S14 B23 (EVO I)	91
S14 B25 (254S1)	114
S14 B25 (EVO II)	114
S38 B35 (356EB)	192
S38 B35 (356ED)	192
S38 B35 (356EE)	192
S38 B35 (356EY)	192
S38 B35 AF	192
S38 B36 (366S1)	193
S38 B36 (366S2)	193
S38 B38 (386S1)	194
S50 326 S4	186
S50 B30 (306S1)	183
S50 B30 (306S2)	183
S50 B32	186
S50 B32 (326S1)	186
S50 B32 (326S3)	186
S50 B32 (326S4)	186
S52 B32	186
S52 B32 (326S2)	186
S54 B32 (326S4)	187
S55 B30 A	183





















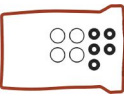

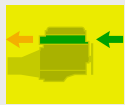













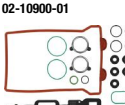
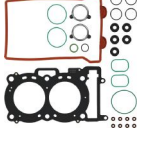





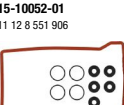
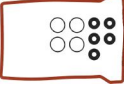
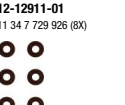
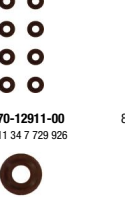















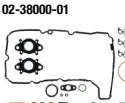





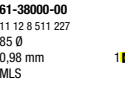



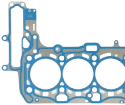
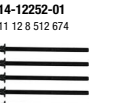
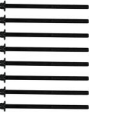
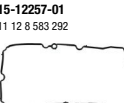
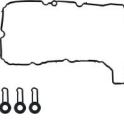
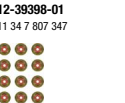



S58 B30 A	184
S62 B50 (508S1)	210
S63 B44 A	206-207
S63 B44 B	207
S65 B40 A	196
S65 B44 A	208
S70 B56 (56121)	212
S85 B50 A	211































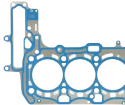

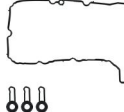













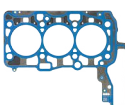

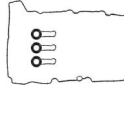















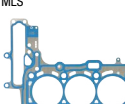

**W**

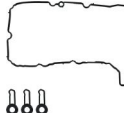
W20K06A	5
---------	---

BMW



















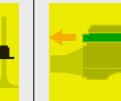













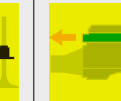



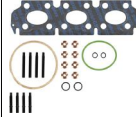
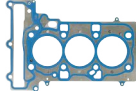

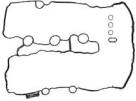



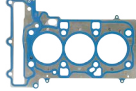

<p>Ltr.  W20K06A</p> <p>125 kW (170 PS)</p> <p>i3 Hybrid (I01)</p> <p>08/13 </p>		 <p>02-10900-01</p> 			 <p>61-10261-00</p> <p>11 12 7 729 541</p> <p>81 Ø</p> <p>0,5 mm</p> <p>MLS</p> 		 <p>15-10052-01</p> <p>11 12 8 551 906</p> 	 <p>12-12911-01</p> <p>11 34 7 729 926 (8X)</p> 	 <p>71-12908-00  2x</p> <p>11 61 8 535 547</p>  <p>71-12905-00   2x</p> <p>11 61 8 535 548</p> <p>8x</p> <p>71-12911-00</p> <p>11 34 7 729 926</p>  <p>71-12904-00  </p> <p>11 65 7 845 076</p> 	 <p>70-31414-10</p> 	 <p>81-10494-00 </p> <p>11 14 8 544 855</p> <p>54x70</p> <p>FPM</p> 
<p>0,7 W20K06A</p> <p>135 kW (184 PS)</p> <p>i3 s Range Extender (I01)</p> <p>11/17</p>		 <p>02-10900-01</p> 			 <p>61-10261-00</p> <p>11 12 7 729 541</p> <p>81 Ø</p> <p>0,5 mm</p> <p>MLS</p> 		 <p>15-10052-01</p> <p>11 12 8 551 906</p> 	 <p>12-12911-01</p> <p>11 34 7 729 926 (8X)</p> 	 <p>71-12908-00  2x</p> <p>11 61 8 535 547</p>  <p>71-12905-00   2x</p> <p>11 61 8 535 548</p> <p>8x</p> <p>71-12911-00</p> <p>11 34 7 729 926</p>  <p>71-12904-00  </p> <p>11 65 7 845 076</p> 	 <p>70-31414-10</p> 	 <p>81-10494-00 </p> <p>11 14 8 544 855</p> <p>54x70</p> <p>FPM</p> 
<p>1,5 B37 C15A</p> <p>70-85 kW (95-116 PS)</p> <p>214 d (F45)</p> <p>214 d (F46)</p> <p>216 d (F45)</p> <p>216 d (F46)</p> <p>03/14</p>		 <p>02-38000-01</p> 		 <p>04-10368-01 </p> 	 <p>61-38000-00</p> <p>11 12 8 511 227</p> <p>85 Ø</p> <p>0,98 mm</p> <p>MLS</p> <p>1 </p> <p>61-38000-10</p> <p>11 12 8 511 228</p> <p>85 Ø</p> <p>1,08 mm</p> <p>MLS</p> <p>2 </p> <p>61-38000-20</p> <p>11 12 8 511 229</p> <p>85 Ø</p> <p>1,18 mm</p> <p>MLS</p> <p>3 </p> 	 <p>14-12252-01</p> <p>11 12 8 512 674</p> 	 <p>15-12257-01</p> <p>11 12 8 583 292</p> 	 <p>12-39398-01</p> <p>11 34 7 807 347</p>  <p>70-39398-00</p> <p>16x</p> 	 <p>71-11831-00  3x</p> <p>11 61 8 571 001</p>  <p>71-12257-00  1x</p> <p>11 62 8 511 758</p> 	 <p>70-31414-10</p> 	 <p>81-39379-00 </p> <p>11 14 7 797 490</p> <p>90x104</p> <p>LD FPM</p> 

BMW

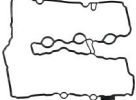
<p>Ltr. </p>											
<p>1,5 B37 C15 A 85 kW (116 PS) X1 sDrive 16 d (F48) 11/14</p>		<p>02-38000-01</p> 		<p>04-10368-01 </p> 	<p>61-38000-00 11 12 8 511 227 85 Ø 0,98 mm MLS </p> <p>61-38000-10 11 12 8 511 228 85 Ø 1,08 mm MLS </p> <p>61-38000-20 11 12 8 511 229 85 Ø 1,18 mm MLS </p> 	<p>14-12252-01 11 12 8 512 674</p> 	<p>15-12257-01 11 12 8 583 292</p> 	<p>12-39398-01 11 34 7 807 347</p> 	<p>71-11831-00  3x 11 61 8 571 001</p>  <p>71-12257-00  11 62 8 511 758</p> 	<p>70-31414-10</p> 	<p>81-39379-00 </p> <p>11 14 7 797 490 90x104 LD FPM</p> 
<p>1,5 B37 C15 A 85 kW (116 PS) 116 d (F40) 216 d (F44) 07/19 <b>[NEW]</b></p>		<p>02-11345-01</p>	<p>08-11345-01</p>	<p>04-10368-01 </p> 	<p>61-10155-00 11 12 8 594 563 84,7 Ø 1,43 mm MLS </p> <p>61-10155-10 11 12 8 594 564 84,7 Ø 1,53 mm MLS </p> <p>61-10155-20 11 12 8 594 565 84,7 Ø 1,63 mm MLS </p> 	<p>14-12252-01 11 12 8 512 674</p> 	<p>15-11216-01 11 12 8 473 264</p> 	<p>12-39398-01 11 34 7 807 347</p>  <p>70-39398-00 16x </p>	<p>71-11831-00  3x 11 61 8 571 001</p>  <p>71-12257-00  1x 11 62 8 511 758</p> 	<p>70-31414-10</p> 	<p>81-10651-00 </p> <p>11 14 8 580 936 52 Ø PTFE</p> <p>81-10659-00 </p> <p>11 14 8 599 771 90x104 AB LD FPM</p> 
<p>1,5 B37 D15 A 70-85 kW (95-116 PS) 114 d (F20) 114 d (F21) 116 d (F21) 03/15</p>		<p>02-38000-01</p> 		<p>04-10368-01 </p> 	<p>61-38000-00 11 12 8 511 227 85 Ø 0,98 mm MLS </p> <p>61-38000-10 11 12 8 511 228 85 Ø 1,08 mm MLS </p> <p>61-38000-20 11 12 8 511 229 85 Ø 1,18 mm MLS </p> 	<p>14-12252-01 11 12 8 512 674</p> 	<p>15-12257-01 11 12 8 583 292</p> 	<p>12-39398-01 11 34 7 807 347</p> 	<p>71-11831-00  2x 11 61 8 571 001</p>  <p>71-12257-00  11 62 8 511 758</p> 	<p>70-31414-10</p> 	<p>81-39379-00 </p> <p>11 14 7 797 490 90x104 LD FPM</p> 

BMW

















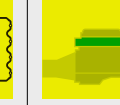
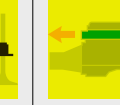
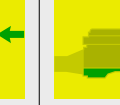

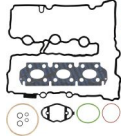
Ltr.	Motor	Power	Model	Date	02-38000-01	04-10368-01	61-38000-00	14-12252-01	15-12257-01	12-38398-01	71-11831-00	70-31414-10	81-39379-00
1,5	B37 D15 A	85 kW (116 PS)	116 d (F20)	03/15-06/19			<p><b>61-38000-00</b> 11 12 8 511 227 85 Ø 0,98 mm MLS</p> <p><b>61-38000-10</b> 11 12 8 511 228 85 Ø 1,08 mm MLS</p> <p><b>61-38000-20</b> 11 12 8 511 229 85 Ø 1,18 mm MLS</p>				<p><b>71-11831-00</b> </p> 11 61 8 571 001		<p><b>81-39379-00</b> </p> 11 14 7 797 490 90x104 LD FPM
1,5	B38 A15 A	75-165 kW (102-224 PS)	216 i Active Tourer (F45) 216 i (F46) 225 xe (F45)	09/14-10/21		<p><b>08-10448-01</b> </p> 06/15→	<p><b>61-42180-00</b> 11 12 8 630 683 83 Ø 0,7 mm MLS</p> <p><b>61-42180-10</b> 11 12 8 630 684 83 Ø 1 mm MLS</p>				<p><b>71-11403-00</b> </p> 11 61 7 633 493		<p><b>81-10448-00</b> </p> 11 14 8 602 594 90x104 LD PTFE ACM
1,5	B38 A15 A	80-100 kW (109-136 PS)	X1 sDrive 18 i (F48) 216 i (F45) 216 i (F46)	11/15		<p><b>08-10448-01</b> </p>	<p><b>61-42180-00</b> 11 12 8 630 683 83 Ø 0,7 mm MLS</p> <p><b>61-42180-10</b> 11 12 8 630 684 83 Ø 1 mm MLS</p>				<p><b>71-11403-00</b> </p> 11 61 7 633 493		<p><b>81-10448-00</b> </p> 11 14 8 602 594 90x104 LD PTFE ACM

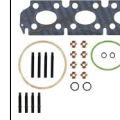
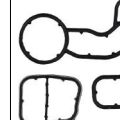
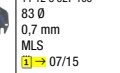
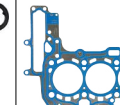
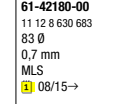
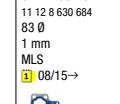
BMW															
Ltr.															
1,5	B38 A15 A	80-100 kW (109-136 PS)	116 i (F40) 118 i (F40) 218 i (F44)	11/20 <b>[NEW]</b>											
					02-11339-01 	08-11339-01	04-10336-01  	61-10165-00 11 12 7 934 598 83 Ø 0,7 mm MLS  61-10165-10 11 12 7 934 599 83 Ø 1 mm MLS 	14-12261-01 	15-11208-01 11 12 9 797 195 	12-36866-03 11 34 0 038 719 	71-11403-00  3x 11 61 7 633 493 	70-31414-10 	81-10651-00  11 14 8 580 936 52 Ø PTFE  81-10448-00  11 14 8 602 594 90x104 LD PTFE ACM 	
1,5	B38 A15 A	100 kW (136 PS)	X2 sDrive 18 i (F39)	03/18				61-10165-00 11 12 7 934 598 83 Ø 0,7 mm MLS  61-10165-10 11 12 7 934 599 83 Ø 1 mm MLS 	14-12261-01 	71-17063-00 11 12 8 638 245 	12-36866-03 11 34 0 038 719 	71-11403-00  3x 11 61 7 633 493 	70-31414-10 	81-10448-00  11 14 8 602 594 90x104 LD PTFE ACM 	

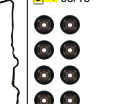
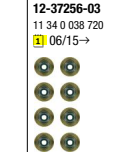



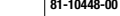







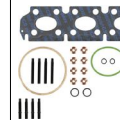

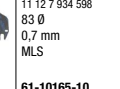
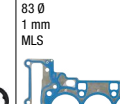
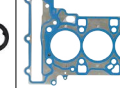
BMW

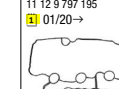
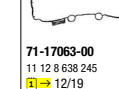
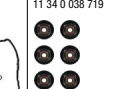
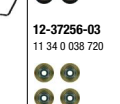
Ltr.  1,5 B38 A15 A 100 kW (136 PS) 218 i (F45) 218 i (F46)  07/14

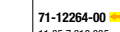
										
	02-38180-01 	08-10448-01 	04-10336-01  15-10048-01 	61-38180-00 11 12 8 627 105 83 Ø 0,7 mm MLS  07/15 61-38180-10 11 12 8 627 106 83 Ø 1 mm MLS  07/15 61-42180-00 11 12 8 630 683 83 Ø 0,7 mm MLS  08/15→ 61-42180-10 11 12 8 630 684 83 Ø 1 mm MLS  08/15→	14-12261-01 	71-11406-00 11 12 8 618 515 	12-36866-03 11 34 0 038 719  08/15 12-37256-03 11 34 0 038 720  06/15→	71-11403-00  11 61 7 633 493 3x 71-12264-00  11 65 7 618 035	70-31414-10 	81-10448-00  11 14 8 602 594 90x104 LD PTFE ACM 

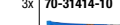
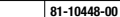
1,5 B38 A15 A 103 kW (140 PS) X1 sDrive 18 i (F48) 07/17

	02-11339-01 	08-11339-01 	04-10336-01  15-10048-01 	61-10165-00 11 12 7 934 598 83 Ø 0,7 mm MLS  61-10165-10 11 12 7 934 599 83 Ø 1 mm MLS  61-10165-00 11 12 7 934 598 83 Ø 0,7 mm MLS  61-10165-10 11 12 7 934 599 83 Ø 1 mm MLS  08/15→	14-12261-01 	15-11208-01 11 12 9 797 195  01/20→ 71-17063-00 11 12 8 638 245  12/19	12-36866-03 11 34 0 038 719  12-37256-03 11 34 0 038 720  12/19	71-11403-00  11 61 7 633 493 3x 71-12264-00  11 65 7 618 035 71-19735-00  11 65 8 631 699	70-31414-10 	81-10448-00  11 14 8 602 594 90x104 LD PTFE ACM 
---	---	---	---	--	--	---	---	---	--	---

BMW														
Ltr.														
1,5	B38 A15 A	103 kW (140 PS)	X2 sDrive 18 i (F39)	03/18										
					02-38180-01 		04-10336-01 11 12 7 934 598 83 Ø 0,7 mm MLS  15-10048-01 11 42 8 591 460 	61-10165-00 11 12 7 934 598 83 Ø 0,7 mm MLS  61-10165-10 11 12 7 934 599 83 Ø 1 mm MLS 	14-12261-01 	71-17063-00 11 12 8 638 245 	12-36866-03 11 34 0 038 719 	71-11403-00  3x 11 61 7 633 493  71-12264-00 11 65 7 618 035 	70-31414-10 	81-10448-00 11 14 8 602 594 90x104 LD PTFE ACM 
1,5	B38 A15 A	103 kW (140 PS)	118 i (F40) 218 i (F44)	07/19 <b>[NEW]</b>		02-11339-01 	08-11339-01	04-10336-01 11 12 7 934 598 83 Ø 0,7 mm MLS  61-10165-10 11 12 7 934 599 83 Ø 1 mm MLS 	14-12261-01 	15-11208-01 11 12 9 797 195  71-17063-00 11 12 8 638 245  12/19	12-36866-03 11 34 0 038 719  12-37256-03 11 34 0 038 720 	71-11403-00  3x 11 61 7 633 493  71-19735-00 11 65 8 631 699 	70-31414-10 	81-10651-00 11 14 8 580 936 52 Ø PTFE  81-10448-00 11 14 8 602 594 90x104 LD PTFE ACM 
1,5	B38 A15 A	103 kW (140 PS)	218 i (F45)	03/18-10/21		02-11339-01 	08-11339-01	04-10336-01 11 12 7 934 598 83 Ø 0,7 mm MLS  15-10048-01 11 42 8 591 460 	14-12261-01 	71-17063-00 11 12 8 638 245  12/19	12-36866-03 11 34 0 038 719  12-37256-03 11 34 0 038 720 	71-11403-00  3x 11 61 7 633 493  71-19735-00 11 65 8 631 699 	70-31414-10 	81-10448-00 11 14 8 602 594 90x104 LD PTFE ACM 

















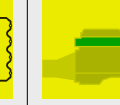
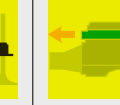
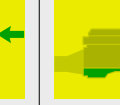























































BMW															
1,5	B38 A15 A	103 kW (140 PS)	218 i (F46)	04/17		<p><b>02-38180-01</b> 11 12 8 630 683 83 Ø 0,7 mm MLS 1 ⇒ 02/18</p>	<p><b>08-10448-01</b> 11 12 8 630 683 83 Ø 0,7 mm MLS 1 ⇒ 02/18</p>	<p><b>04-10336-01</b> </p>	<p><b>61-42180-00</b> 11 12 8 630 684 83 Ø 0,7 mm MLS 1 ⇒ 02/18</p>	<p><b>14-12261-01</b></p>	<p><b>15-11208-01</b> 11 12 9 797 195 01/20 →</p>	<p><b>12-36866-03</b> 11 34 0 038 719</p>	<p><b>71-11403-00</b>  3x 11 61 7 633 493</p>	<p><b>70-31414-10</b></p>	<p><b>81-10448-00</b> </p> <p>11 14 8 602 594 90x104 LD PTFE ACM</p>
					<p><b>02-11339-01</b> 03/18 →</p>	<p><b>08-11339-01</b> 03/18 →</p>	<p><b>15-10048-01</b> </p> <p>11 42 8 591 460</p>	<p><b>61-42180-10</b> 11 12 8 630 684 83 Ø 1 mm MLS 1 ⇒ 02/18</p>	<p><b>61-10165-00</b> 11 12 7 934 598 83 Ø 0,7 mm MLS 1 ⇒ 03/18 →</p>		<p><b>71-11406-00</b> 11 12 8 618 515 02/18</p>	<p><b>12-37256-03</b> 11 34 0 038 720</p>	<p><b>71-12264-00</b> </p> <p>11 65 7 618 035</p>		
1,5	B38 A15 A	162 kW (220 PS)	X1 xDrive 25 e (F48)	03/20 <b>[NEW]</b>		<p><b>02-11362-01</b></p>	<p><b>08-11362-01</b></p>	<p><b>04-10336-01</b> </p>	<p><b>61-42180-10</b> 11 12 8 630 684 83 Ø 1 mm MLS</p>	<p><b>14-12261-01</b></p>	<p><b>71-11406-00</b> 11 12 8 618 515</p>	<p><b>12-36866-03</b> 11 34 0 038 719</p>	<p><b>71-11403-00</b>  3x 11 61 7 633 493</p>	<p><b>70-31414-10</b></p>	<p><b>81-10651-00</b> </p> <p>11 14 8 580 936 52 Ø PTFE</p> <p><b>81-10448-00</b> </p> <p>11 14 8 602 594 90x104 LD PTFE ACM</p>
1,5	B38 A15 C	100 kW (136 PS)	118 i (F52)	01/17-08/19				<p><b>04-10336-01</b> </p>		<p><b>14-12261-01</b></p>		<p><b>12-36866-03</b> 11 34 0 038 719</p>	<p><b>71-12264-00</b> </p> <p>11 65 7 618 035</p>	<p><b>70-31414-10</b></p>	<p><b>81-10448-00</b> </p> <p>11 14 8 602 594 90x104 LD PTFE ACM</p>

BMW





































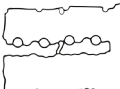























Ltr.	BMW	Power	Models	Year	Image 1	Image 2	Image 3	Image 4	Image 5	Image 6	Image 7	Image 8	Image 9	Image 10	Image 11	Image 12
1,5	B38 B15 A	80-100 kW (109-136 PS)	116 i (F20) 116 i (F21) 118 i (F20) 218 i (F22, F87) 218 i (F23) 318 i (F30, F80) 318 i (F31) 418 i (F32, F82) 418 i (F36)	03/15												
						02-38180-01 		04-10336-01 	61-42180-00 11 12 8 630 683 83 Ø 0,7 mm MLS  61-42180-10 11 12 8 630 684 83 Ø 1 mm MLS 	14-12261-01 	71-11406-00 11 12 8 618 515 	12-36866-03 11 34 0 038 719  12-37256-03 11 34 0 038 720 	71-11403-00 11 61 7 633 493 3x 71-12264-00 11 65 7 618 035 	70-31414-10 	81-10448-00 11 14 8 602 594 90x104 LD PTFE ACM 	
1,5	B38 B15 A	100 kW (136 PS)	118 i (F21)	03/15		02-38180-01 			61-42180-00 11 12 8 630 683 83 Ø 0,7 mm MLS  61-42180-10 11 12 8 630 684 83 Ø 1 mm MLS 	14-12261-01 	71-11406-00 11 12 8 618 515 	12-36866-03 11 34 0 038 719  12-37256-03 11 34 0 038 720 	71-11403-00 11 61 7 633 493 3x 71-12264-00 11 65 7 618 035 	70-31414-10 	81-10448-00 11 14 8 602 594 90x104 LD PTFE ACM 	
1,5	B38 K15 A	266-275 kW (362-374 PS)	i8 (I12) i8 (I15)	03/14-06/20					61-42180-00 11 12 8 630 683 83 Ø 0,7 mm MLS  61-42180-10 11 12 8 630 684 83 Ø 1 mm MLS 	14-13082-02 11 12 8 644 675 (8X) 	71-11406-00 11 12 8 618 515 	12-36866-03 11 34 0 038 719  12-37256-03 11 34 0 038 720 	11-12910-02  71-12297-00 11 62 7 625 167 	70-31414-10 	81-10448-00 11 14 8 602 594 90x104 LD PTFE ACM 	

BMW

Ltr.  M10 B15 59 kW (80 PS) 1500  10/62-07/66

										
	<p><b>02-24185-04</b> 11 12 1 260 670</p> 	<p><b>08-19737-03</b> 11 11 1 734 114</p> 	<p><b>15-19747-01</b>  11 14 1 727 986</p> 	<p><b>61-24185-50</b> 11 12 9 065 653 86 Ø 1,5 mm</p> 		<p><b>71-19738-50</b> 11 12 1 734 276</p> 	<p><b>12-21025-01</b> 11 34 1 256 556 (8x)</p>                                           	<p><b>71-19741-10</b>  3x 11 61 1 734 436</p>  <p><b>71-19742-20</b>  11 61 1 734 435</p>  <p><b>71-28708-10</b>  4x 11 62 1 723 838</p>  <p><b>71-21007-30</b>   18 11 1 728 363</p> 	<p><b>71-19737-20</b> 11 13 1 727 974</p> 	<p><b>81-19866-00</b>  11 14 1 709 632 35x55 A SL RD ACM</p>  <p><b>81-18304-00</b>  11 14 1 255 015 80x100 A LD MVQ</p>  <p><b>81-20745-40</b>  11 14 2 245 364 90x110 A SL LD FPM</p> 

1,6 B48 B16 A 125 kW (170 PS) 320 i (G20, G80) 03/19

















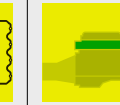
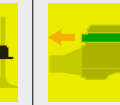
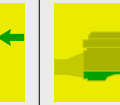

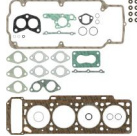













				<p><b>61-10076-00</b> 11 12 8 654 272 82 Ø 0,7 mm MLS</p> <p><b>61-10076-10</b> 11 12 8 654 273 82 Ø 1 mm MLS</p> 	<p><b>14-13082-01</b> 11 12 8 644 675 (10X)</p>                         	<p><b>71-11411-00</b> 11 12 8 618 519</p> 	<p><b>12-36866-03</b> 11 34 0 038 719</p>                         	<p><b>71-12439-00</b>  4x 11 61 8 637 800</p>  <p><b>71-11394-00</b>  11 62 7 617 523</p> 	<p><b>70-31414-10</b></p> 	<p><b>81-37002-00</b>  11 11 8 604 931 55x68 AB RD PTFE</p>  <p><b>81-10448-00</b>  11 14 8 602 594 90x104 LD PTFE ACM</p> 
--	--	--	--	---	--	---	--	---	---	--

BMW













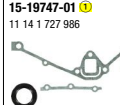
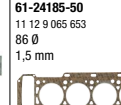
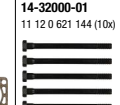
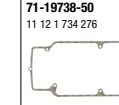
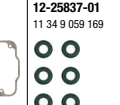

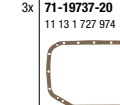

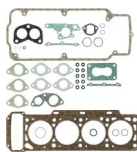





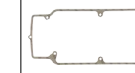







Ltr.	Motor	Power (kW/PS)	Models	Year	Image 1	Image 2	Image 3	Image 4	Image 5	Image 6	Image 7	Image 8	Image 9	Image 10	Image 11	Image 12		
1,6	B48 B16 A	125 kW (170 PS)	420 i (G22, G82) 520 i (G30, F90)	07/17														
									<p><b>61-10076-00</b> 11 12 8 654 272 82 Ø 0,7 mm MLS</p> <p><b>61-10076-10</b> 11 12 8 654 273 82 Ø 1 mm MLS</p>	<p><b>14-13082-01</b> 11 12 8 644 675 (10x)</p>	<p><b>71-11411-00</b> 11 12 8 618 519</p>	<p><b>12-36866-03</b> 11 34 0 038 719</p> <p><b>12-37256-01</b> 11 34 0 035 853</p> <p><b>70-36866-00 ES</b> 8x 11 34 7 539 918</p> <p><b>70-37256-00 AS</b> 6x 11 34 7 573 689</p>	<p><b>71-12439-00</b>  4x 11 61 8 637 800</p> <p><b>71-11394-00</b>  11 62 7 617 523</p>	<p><b>70-31414-10</b></p>	<p><b>81-37002-00</b> </p> <p>11 11 8 604 931 55x68 AB RD PTFE</p> <p><b>81-10448-00</b> </p> <p>11 14 8 602 594 90x104 LD PTFE ACM</p>			
1,6	M10 B16 A M10 B16 (16A)	59-77 kW (80-105 PS)	1500 1600 1600 (E6) 1600 GT 1600 Ti (E10) 1600/2 (E10) 1602 (E10)	09/63-07/75					<p><b>02-24185-04</b> 11 12 1 260 670</p>	<p><b>08-19737-03</b> 11 11 1 734 114</p>	<p><b>15-19747-01</b>  11 14 1 727 986</p>	<p><b>61-24185-50</b> 11 12 9 065 653 86 Ø 1,5 mm</p>		<p><b>71-19738-50</b> 11 12 1 734 276</p>	<p><b>12-21025-01</b> 11 34 1 256 556 (8x)</p> <p><b>70-21025-00</b> 11 34 1 256 556</p>	<p><b>71-19741-10</b>  11 61 1 734 436</p> <p><b>71-19742-20</b>  11 61 1 734 435</p> <p><b>71-28708-10</b>  11 62 1 723 838</p> <p><b>71-21007-30</b>  18 11 1 728 363</p>	<p><b>71-19737-20</b> 11 13 1 727 974</p>	<p><b>81-19866-10</b> </p> <p>11 14 1 709 632 35x55 A SL RD ACM</p> <p><b>81-18304-00</b> </p> <p>11 14 1 255 015 80x100 A LD MVO</p> <p><b>81-20745-40</b> </p> <p>11 14 2 245 364 90x110 A SL LD FPM</p>

BMW

Ltr.  1.6 M10 B16 (16A) 55 kW (75 PS) 1502 (E10)  01/75-07/77













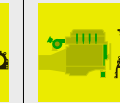
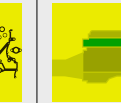
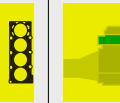
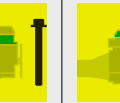
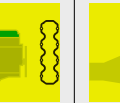
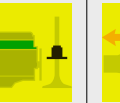
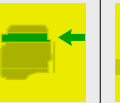



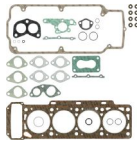

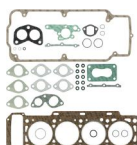
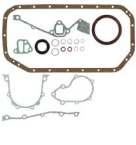

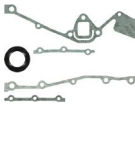



















										
	<p><b>02-24185-04</b> 11 12 1 260 670</p> 	<p><b>08-19737-03</b> 11 11 1 734 114</p> 	<p><b>15-19747-01</b> </p> <p>11 14 1 727 986</p> 	<p><b>61-24185-50</b> 11 12 9 065 653 86 Ø 1,5 mm</p> 	<p><b>14-32000-01</b> 11 12 0 621 144 (10x)  08/75→</p> 	<p><b>71-19738-50</b> 11 12 1 734 276</p> 	<p><b>12-21025-01</b> 11 34 1 256 556 (8x)</p> 	<p><b>71-19741-10</b>  3x 11 61 1 734 436</p>  <p><b>71-19742-20</b>  11 61 1 734 435</p>  <p><b>71-28708-10</b>  4x 11 62 1 723 838</p>  <p><b>71-21007-30</b>   18 11 1 728 363</p> 	<p><b>71-19737-20</b> 11 13 1 727 974</p> 	<p><b>81-19866-10</b>  11 14 1 709 632 35x55 A SL RD ACM</p>  <p><b>81-18304-00</b>  11 14 1 255 015 80x100 A LD MVQ</p>  <p><b>81-20745-40</b>  11 14 2 245 364 90x110 A SL LD FPM</p> 

1,6 M10 B16 (16A) 55 kW (75 PS) 315 (E21) 03/81-12/91  
M10 B16 (164VB) 315 (E30)











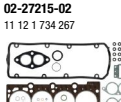

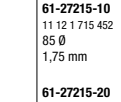
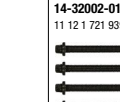
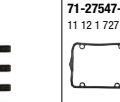
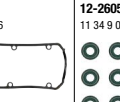

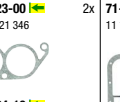
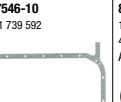
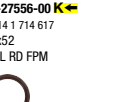

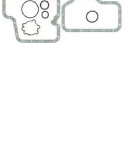

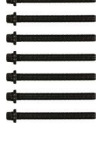











										
	<p><b>02-24185-05</b> 11 12 9 065 702</p> 	<p><b>08-19737-03</b> 11 11 1 734 114</p> 	<p><b>15-19747-01</b> </p> <p>11 14 1 727 986</p> 	<p><b>61-24185-50</b> 11 12 9 065 653 86 Ø 1,5 mm</p> 	<p><b>14-32000-01</b> 11 12 0 621 144 (10x)</p> 	<p><b>71-19738-50</b> 11 12 1 734 276</p> 	<p><b>12-25837-01</b> 11 34 9 059 169</p> 	<p><b>71-19741-10</b>  3x 11 61 1 734 436</p>  <p><b>71-19742-20</b>  11 61 1 734 435</p>  <p><b>71-28708-10</b>  4x 11 62 1 723 838</p>  <p><b>71-21007-30</b>   18 11 1 728 363</p> 	<p><b>71-19737-20</b> 11 13 1 727 974</p> 	<p><b>81-19866-10</b>  11 14 1 709 632 35x55 A SL RD ACM</p>  <p><b>81-18304-00</b>  11 14 1 255 015 80x100 A LD MVQ</p>  <p><b>81-20745-40</b>  11 14 2 245 364 90x110 A SL LD FPM</p> 

BMW

Ltr.  1,6 M10 B16 (164VA) 66 kW (90 PS) 316 (E21)  08/75-08/80

											
	<p><b>02-24185-04</b> 11 12 1 260 670  07/78</p>  <p><b>02-24185-05</b> 11 12 9 065 702  08/78→</p> 	<p><b>08-19737-03</b> 11 11 1 734 114</p> 	<p><b>15-19747-01</b> </p> <p>11 14 1 727 986</p> 	<p><b>61-24185-50</b> 11 12 9 065 653 86 Ø 1,5 mm</p> 	<p><b>14-32000-01</b> 11 12 0 621 144 (10x)</p> 	<p><b>71-19738-50</b> 11 12 1 734 276</p> 	<p><b>12-21025-01</b> 11 34 1 256 556 (8x)  07/78</p>  <p><b>12-25837-01</b> 11 34 9 059 169  08/78→</p>  <p><b>70-21025-00</b> 11 34 1 256 556  07/78</p>  <p><b>70-25837-00</b> 11 34 1 273 501  08/78→</p> 	<p><b>71-19741-10</b>  3x 11 61 1 734 436</p>  <p><b>71-19742-20</b>  11 61 1 734 435</p>  <p><b>71-28708-10</b> 4x 11 62 1 723 838</p>  <p><b>71-21007-30</b>   18 11 1 728 363</p>  <p>8x</p>  <p>8x</p> 	<p><b>71-19737-20</b> 11 13 1 727 974</p> 	<p><b>81-19866-10</b>  11 14 1 709 632 35x55 A SL RD ACM</p>  <p><b>81-18304-00</b>  11 14 1 255 015 80x100 A LD MVQ</p>  <p><b>81-20745-40</b>  11 14 2 245 364 90x110 A SL LD FPM</p>  	













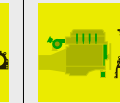
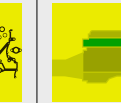
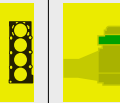
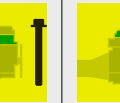
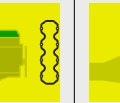
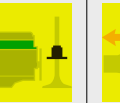
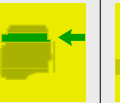



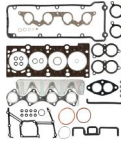

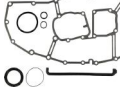

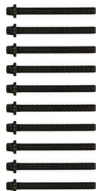
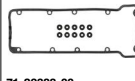

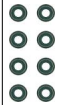









1,6 M40 B16 73-75 kW (99-102 PS) 316 i (E30) 09/87  
M40 B16 C 316 i (E36)  
M40 B16 (164E1)

											
	<p><b>02-27215-02</b> 11 12 1 734 267</p> 	<p><b>08-27546-01</b> 11 11 9 059 257</p> 		<p><b>61-27215-10</b> 11 12 1 715 452 85 Ø 1,75 mm</p> <p><b>61-27215-20</b> 11 12 1 717 867 85 Ø 2,05 mm</p> 	<p><b>14-32002-01</b> 11 12 1 721 939</p> 	<p><b>71-27547-00</b> 11 12 1 727 726</p> 	<p><b>12-26058-02</b> 11 34 9 059 171</p>  <p><b>70-26058-00</b> 11 34 1 288 544</p> 	<p><b>71-27123-00</b>  2x 11 61 1 721 346</p>  <p><b>71-27124-10</b>  11 61 1 734 683</p>  <p><b>71-31334-00</b>  11 62 1 743 719</p>  <p><b>71-27267-00</b>   11 76 1 711 968</p> 	<p><b>71-27546-10</b> 11 13 1 739 592</p>  <p><b>71-27554-00</b>  11 13 1 709 815</p> 	<p><b>81-27556-00</b>  11 14 1 714 617 42x52 A SL RD FPM</p>  <p><b>81-20745-40</b>  11 14 2 245 364 90x110 A SL LD FPM</p>  <p><b>81-24641-10</b>  11 12 1 285 609 38x50 A SL FPM</p>  	











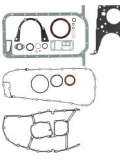

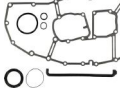
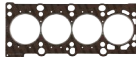

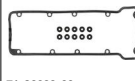
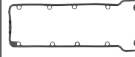
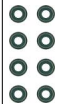







BMW

Ltr.  1,6 M43 B16 (164E2) 75 kW (102 PS) 316 i (E36) 09/93-08/00

											
	<p><b>02-27215-03</b> 11 12 9 066 452 11 → 01/96</p>  <p><b>02-27215-04</b> 11 12 0 007 610 11 → 02/96→</p> 	<p><b>08-27546-04</b> 11 11 9 066 453</p> 	<p><b>15-29366-01</b> </p> 	<p><b>61-27215-10</b> 11 12 1 715 452 85 Ø 1,75 mm</p> <p><b>61-27215-20</b> 11 12 1 717 867 85 Ø 2,05 mm</p> 	<p><b>14-32002-01</b> 11 12 1 721 939</p> 	<p><b>15-29388-01</b> 11 12 1 432 885 +11 12 1 721 879 (10x)</p>  <p><b>71-29388-00</b> 11 12 1 432 885</p> 	<p><b>12-26058-02</b> 11 34 9 059 171</p>  <p><b>70-26058-00</b> 11 34 1 288 544</p> 	<p><b>71-27124-10</b> </p> <p>11 61 1 734 683</p>  <p><b>71-29365-00</b>  2x 11 61 1 739 545 11 → 09/95</p>  <p><b>71-31254-00</b>  2x 11 61 1 247 478 11 → 10/95→</p>  <p><b>71-31334-00</b>  11 62 1 743 719 11 → 02/96→ 11 → 01/96</p>  <p><b>71-27267-00</b>  10 11 76 1 711 968</p> 	<p><b>71-27546-10</b> 11 13 1 739 592 11 → 09/95</p>  <p><b>71-31328-00</b> 11 13 1 739 813 11 → 10/95→</p> 	<p><b>81-28498-00</b>  </p> <p>11 14 1 435 848 44x60 A SL RD FPM</p>  <p><b>81-20745-40</b>  </p> <p>11 14 2 245 364 90x110 A SL LD FPM</p> 	



























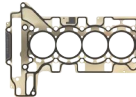

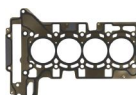

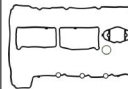
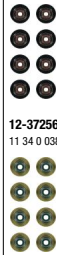

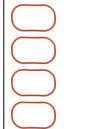







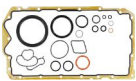

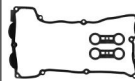

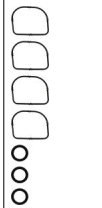

1,6 M43 B16 (164E2) 75 kW (102 PS) 316 i (E36) 02/96-08/00

	<p><b>02-27215-04</b> 11 12 0 007 610</p> 	<p><b>08-27546-04</b> 11 11 9 066 453</p> 	<p><b>15-29366-01</b> </p> 	<p><b>61-27215-10</b> 11 12 1 715 452 85 Ø 1,75 mm</p> <p><b>61-27215-20</b> 11 12 1 717 867 85 Ø 2,05 mm</p> 	<p><b>14-32002-01</b> 11 12 1 721 939</p> 	<p><b>15-29388-01</b> 11 12 1 432 885 +11 12 1 721 879 (10x)</p>  <p><b>71-29388-00</b> 11 12 1 432 885</p> 	<p><b>12-26058-02</b> 11 34 9 059 171</p>  <p><b>70-26058-00</b> 11 34 1 288 544</p> 	<p><b>71-27124-10</b> </p> <p>11 61 1 734 683</p>  <p><b>71-31254-00</b>  2x 11 61 1 247 478</p>  <p><b>71-31334-00</b>  11 62 1 743 719</p>  <p><b>71-27267-00</b>  10 11 76 1 711 968</p> 	<p><b>71-31328-00</b> 11 13 1 739 813</p> 	<p><b>81-28498-00</b>  </p> <p>11 14 1 435 848 44x60 A SL RD FPM</p>  <p><b>81-20745-40</b>  </p> <p>11 14 2 245 364 90x110 A SL LD FPM</p> 
--	---	--	---	---	--	---	--	--	---	---



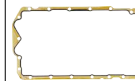































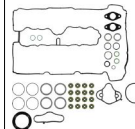
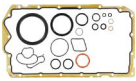
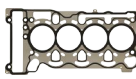
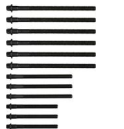

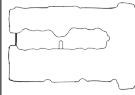

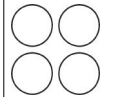





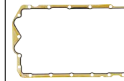





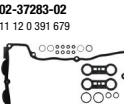
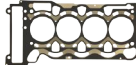
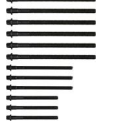
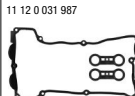

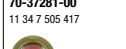













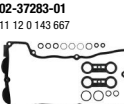

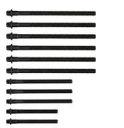
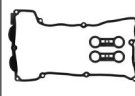
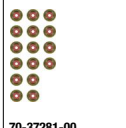



BMW

Ltr.															
1,6	M43 B16 (164E3)	77 kW (105 PS)	316 Ci (E46) 316 i (E46)	04/00-07/06		<b>02-27215-05</b> 11 12 1 439 695 	<b>08-33139-01</b> 11 11 1 712 981 	<b>15-29366-01</b> 	<b>61-27215-10</b> 11 12 1 715 452 85 Ø 1,75 mm  <b>61-27215-20</b> 11 12 1 717 867 85 Ø 2,05 mm 	<b>14-32002-01</b> 11 12 1 721 939 	<b>15-29388-01</b> 11 12 1 432 885 +11 12 1 721 879 (10x) 	<b>12-26058-02</b> 11 34 9 059 171 	<b>71-33179-00</b> 4x 11 61 1 437 384   <b>71-33176-00</b> 4x 11 61 1 437 383 8x   <b>71-31334-00</b> 11 62 1 743 719   <b>71-27267-00</b> 11 76 1 711 968 	<b>71-33139-00</b> 11 13 1 432 109 	<b>81-28498-00</b> 11 14 1 435 848 44x60 A SL RD FPM   <b>81-20745-00</b> 11 14 2 245 364 90x110 A SL LD FPM 
1,6	N13 B16 A	75-130 kW (102-177 PS)	114 i (F20) 114 i (F21) 116 i (F20) 116 i (F21) 118 i (F20) 118 i (F21) 120 i (F20) 120 i (F21) 316 i (F30) 316 i (F31) 320 i (F30)	07/11		<b>02-10506-01</b> 11 12 2 250 713 	<b>04-10358-01</b> 	<b>61-38010-00</b> 11 12 7 595 138 78 Ø 0,9 mm MLS  <b>61-38010-10</b> 11 12 7 586 908 78 Ø 1,3 mm MLS 	<b>14-32347-01</b> 11 12 7 560 274 	<b>15-10506-01</b> 11 12 7 582 400 	<b>12-37621-01</b> 11 34 0 033 950 	<b>71-37621-00</b> 16x 	<b>11-37616-01</b> 11 617 528 340   <b>71-37628-00</b> 11 61 7 528 341   <b>71-11399-00</b> 18 30 7 553 601 	<b>70-31414-10</b> 	<b>81-41219-00</b> 11 11 7 568 264 61x75 A SL RD PTFE (Polytetrafluorethylen)/ACM (Polyacryl-Kautschuk)   <b>81-38532-00</b> 11 11 7 568 263 85x105 A SL LD PTFE (Polytetrafluorethylen)/ACM (Polyacryl-Kautschuk) 
1,6	N20 B16 A	105-125 kW (143-170 PS)	X1 sDrive 16 i (E84) X3 sDrive 18 i (F25)	03/13-08/17		<b>08-10308-01</b> 	<b>04-10357-01</b> 	<b>61-10019-00</b> 11 12 7 620 697 85,1 Ø 0,7 mm MLS  <b>61-10019-10</b> 11 12 7 620 698 85,1 Ø 1 mm MLS 	<b>14-10010-01</b> 11 12 2 212 157 	<b>15-10027-01</b> 11 12 7 588 418 	<b>12-36866-03</b> 11 34 0 038 719 	<b>12-37256-03</b> 11 34 0 038 720 	<b>11-10000-01</b> 11 61 2 212 759   <b>71-10306-00</b> 4x 11 65 7 625 293 	<b>71-10308-00</b> 11 13 7 627 512 	<b>81-10378-00</b> 11 11 8 618 864 65x79 RD FPM   <b>81-40292-00</b> 11 11 7 587 168 90x110 A LD FPM 

BMW

<p>Ltr. </p>											
<p>1,6 N20 B16 A 125 kW (170 PS) 520i (F10, F18) 07/13-10/16</p>			<p>08-10308-01</p> 	<p>04-10357-01 </p> 	<p>61-10019-00 11 12 7 620 697 85,1 Ø 0,7 mm MLS  ⇒ 02/16</p> <p>61-10019-10 11 12 7 620 698 85,1 Ø 1 mm MLS  ⇒ 02/16</p>  <p>61-10208-00 11 12 8 676 519 84 Ø 0,7 mm MLS  03/16→</p> <p>61-10208-10 11 12 8 676 514 84 Ø 1 mm MLS  03/16→</p> 	<p>14-10010-01 11 12 2 212 157</p> 	<p>15-10027-01 11 12 7 588 418</p> 	<p>12-36866-03 11 34 0 038 719</p>  <p>12-37256-03 11 34 0 038 720</p> 	<p>11-10000-01 </p>  <p>71-10306-00  4x</p> 	<p>71-10308-00 11 13 7 627 512</p> 	<p>81-10378-00 </p> <p>11 11 8 618 864 65x79 RD FPM</p>  <p>81-40292-00 </p> <p>11 11 7 587 168 90x110 ALD FPM</p> 
<p>1,6 N40 B16 A N45 B16 A 77-85 kW (105-115 PS) 316 Ci (E46) 316 i (E46) 316 ti (E46) 316 Ti (E46) 06/02-07/06</p>	<p>02-37283-01 11 12 0 143 667</p> 	<p>08-34056-01 11 11 7 511 529</p> 		<p>61-36255-00 11 12 7 509 710 0,4 mm MLS</p> <p>61-36255-10 11 12 7 509 711 0,7 mm MLS</p> 	<p>14-32314-01 11 12 7 511 534</p> 	<p>15-37283-01 11 12 0 031 987</p> 	<p>12-37281-01 11 34 0 054 492</p>  <p>70-37281-00 11 34 7 505 417</p> 	<p>11-37282-01 </p> <p>11 61 7 530 703</p>  <p>71-37279-00 </p> <p>18 40 7 506 778</p>  <p>71-37278-00  </p> <p>18 30 7 506 779</p> 	<p>71-34056-00 11 13 7 511 224</p> 	<p>81-34057-00 </p> <p>11 11 7 547 842 65x79 A SL RD PTFE ACM</p>  <p>81-20745-00 </p> <p>11 14 2 249 533 90x110 AB SL LD PTFE (Polytetrafluorethylen)/ACM (Polyacryl-Kautschuk)</p> 	

BMW













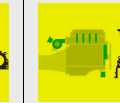
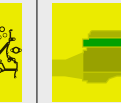
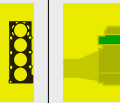
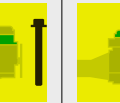
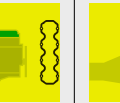
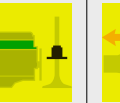
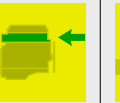



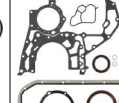

Ltr.															
1,6	N43 B16 A N43 B16 AA	90 kW (122 PS)	116 i (E81, E87) 116 i (E87) 316 i (E90) 316 i (E91) 316 i (E92)	03/07-06/13											
					<p><b>02-37625-01</b> 11 12 7 578 077</p> 	<p><b>08-34056-01</b> 11 11 7 511 529</p> 		<p><b>61-38125-00</b> 11 12 7 563 413 82,8 Ø 0,5 mm MLS</p> <p><b>61-38125-10</b> 11 12 7 578 094 82,8 Ø 0,8 mm MLS</p> 	<p><b>14-32310-01</b> 11 12 7 578 077</p> 	<p><b>15-41338-01</b></p>  <p><b>71-41338-00</b> 11 12 7 555 738</p> 	<p><b>12-37256-02</b> 11 34 0 035 888</p> 	<p><b>11-41336-01</b> </p> <p>11 61 7 546 983</p>  <p><b>71-37134-00</b>  4x</p> <p>18 40 7 530 606</p>  <p><b>71-41337-00</b>  </p> <p>18 30 7 568 564</p> 	<p><b>71-34056-00</b> 11 13 7 511 224</p> 	<p><b>81-34057-00 K</b> </p> <p>11 11 7 547 842 65x79 A SL RD PTFE ACM</p>  <p><b>81-20745-00 K</b> </p> <p>11 14 2 249 533 90x110 AB SL LD PTFE (Polytetrafluorethylen)/ACM (Polyacryl-Kautschuk)</p> 	
1,6	N45 B16 N45 B16 TU2	85-90 kW (115-122 PS)						<p><b>61-36255-00</b> 11 12 7 509 710 0,4 mm MLS</p> <p><b>61-36255-10</b> 11 12 7 509 711 0,7 mm MLS</p> 	<p><b>14-32314-01</b> 11 12 7 511 534</p> 	<p><b>15-37283-01</b> 11 12 0 031 987</p> 	<p><b>12-37281-01</b> 11 34 0 054 492</p>  <p><b>70-37281-00</b> 16x 11 34 7 505 417</p> 	<p><b>11-37284-01</b> </p> <p>11 61 7 528 584</p>  <p><b>71-37286-00</b> </p> <p>18 30 7 540 797</p>  <p><b>71-37287-00</b>  </p> <p>18 30 7 540 798</p> 	<p><b>71-34056-00</b> 11 13 7 511 224</p> 	<p><b>81-34057-00 K</b> </p> <p>11 11 7 547 842 65x79 A SL RD PTFE ACM</p>  <p><b>81-20745-00 K</b> </p> <p>11 14 2 249 533 90x110 AB SL LD PTFE (Polytetrafluorethylen)/ACM (Polyacryl-Kautschuk)</p> 	
1,6	N45 B16 A	85 kW (115 PS)	116 i (E87)	09/07-12/11				<p><b>61-37625-00</b> 11 12 7 563 412 85 Ø 0,5 mm MLS</p> <p><b>61-37625-10</b> 11 12 7 578 093 85 Ø 0,8 mm MLS</p> 	<p><b>14-32310-01</b> 11 12 7 578 077</p> 	<p><b>15-37283-01</b> 11 12 0 031 987</p> 	<p><b>12-37281-01</b> 11 34 0 054 492</p>  <p><b>70-37281-00</b> 16x 11 34 7 505 417</p> 	<p><b>11-37282-01</b> </p> <p>11 61 7 530 703</p>  <p><b>71-37279-00</b> </p> <p>18 40 7 506 778</p>  <p><b>71-37278-00</b>  </p> <p>18 30 7 506 779</p> 	<p><b>71-34056-00</b> 11 13 7 511 224</p> 	<p><b>81-34057-00 K</b> </p> <p>11 11 7 547 842 65x79 A SL RD PTFE ACM</p>  <p><b>81-20745-00 K</b> </p> <p>11 14 2 249 533 90x110 AB SL LD PTFE (Polytetrafluorethylen)/ACM (Polyacryl-Kautschuk)</p> 	

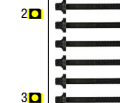
BMW

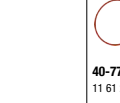











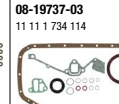
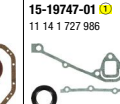

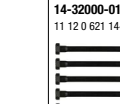
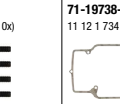
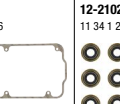
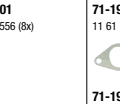
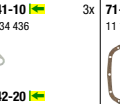
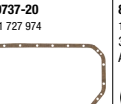

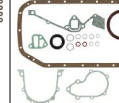
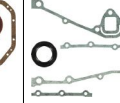

Ltr.														
1,6	N45 B16 A N45 B16 AC	85 kW (115 PS)	116 i (E87) 316 i (E90)	06/04		<b>02-37283-01</b> 11 12 0 143 667 	<b>08-34056-01</b> 11 11 7 511 529 	<b>61-36255-00</b> 11 12 7 509 710 0,4 mm MLS 1) ⇒ 01/07  <b>61-36255-10</b> 11 12 7 509 711 0,7 mm MLS 1) ⇒ 01/07   <b>61-37625-00</b> 11 12 7 563 412 85 Ø 0,5 mm MLS 1) 02/07→  <b>61-37625-10</b> 11 12 7 578 093 85 Ø 0,8 mm MLS 1) 02/07→  	<b>14-32314-01</b> 11 12 7 511 534 1) ⇒ 01/07   <b>14-32310-01</b> 11 12 7 578 077 1) 02/07→ 	<b>15-37283-01</b> 11 12 0 031 987 	<b>12-37281-01</b> 11 34 0 054 492   <b>70-37281-00</b> 11 34 7 505 417 16x   <b>71-37279-00</b> 18 40 7 506 778   <b>71-37278-00</b> 6S 18 30 7 506 779 	<b>11-37282-01</b> 1 11 61 7 530 703   <b>71-37279-00</b> 18 40 7 506 778   <b>71-37278-00</b> 6S 18 30 7 506 779 	<b>71-34056-00</b> 11 13 7 511 224 	<b>81-34057-00 K</b> 1 11 11 7 547 842 65x79 A SL RD PTFE ACM   <b>81-20745-00 K</b> 1 11 14 2 249 533 90x110 AB SL LD PTFE (Polytetrafluorethylen)/ACM (Polyacryl-Kautschuk) 
1,6	N47 D16 A	70-85 kW (95-116 PS)	114 d (F20) 114 d (F21) 116 d (F20) 116 d (F21)	12/11		<b>02-10049-01</b> 	<b>04-10114-01</b> 10 	<b>61-10049-00</b> 11 12 8 509 149 78,7 Ø 0,95 mm MLS 1) 1  <b>61-10049-10</b> 11 12 8 509 150 78,7 Ø 1,05 mm MLS 2) 2  <b>61-10049-20</b> 11 12 8 509 151 78,7 Ø 1,15 mm MLS 3) 3  	<b>14-10398-01</b> 11 12 7 807 294 	<b>15-41286-01</b> 11 12 8 511 814 	<b>12-39398-01</b> 11 34 7 807 347   <b>70-39398-00</b> 16x 	<b>71-10389-00</b> 1 11 61 8 506 407   <b>71-39421-10</b> 2x 11 62 8 509 783   <b>70-31414-10</b> 	<b>81-39382-00 K</b> 1 11 11 7 802 665 55x68 RD FPM   <b>81-39379-00 K</b> 1 11 14 7 797 490 90x104 LD FPM 	

BMW

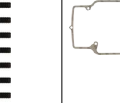









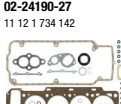
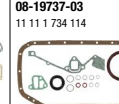
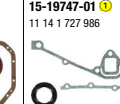

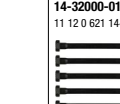
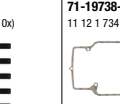
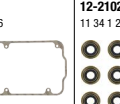

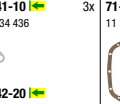
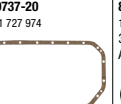

Ltr.  M41 D17 (174T1) 66 kW (90 PS) 318 tds (E36) 01/95-08/00

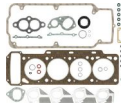
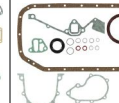
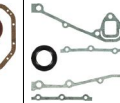
											
	<b>02-31877-01</b> 11 12 2 246 704	<b>08-31876-01</b> 11 11 2 246 703	<b>04-10029-01</b> 	<b>61-31915-00</b> 11 12 2 246 093 81 Ø 1,68 mm	<b>14-32004-02</b> 11 12 9 067 792	<b>15-31877-01</b> 11 12 2 245 599 +11 12 2 245 844 (6x)	<b>12-31306-07</b> 11 34 9 065 438	<b>40-77534-00</b>  11 61 2 245 438	<b>71-31876-00</b> 11 13 9 067 655	<b>81-17404-50</b>  11 14 1 265 431 48x65 AB SL RD FPM	
				<b>61-31915-10</b> 11 12 2 246 092 81 Ø 1,87 mm				<b>40-77535-00</b>  11 61 2 245 439		<b>81-20745-40</b>  11 14 2 245 364 90x110 A SL LD FPM	
							<b>70-31306-00</b> 11 34 2 245 151	<b>71-29396-00</b>  11 62 2 243 782	<b>71-31854-00</b>  11 62 2 245 274		

1,8 M10 B18 66-77 kW (90-105 PS) 1800 07/69  
 M10 B18 (184EA) 1802 (E10)  
 M10 B18 (184EB) 1802 (E6)  
 M10 B18 (184EW) 2000  
 M10 B18 (184EY) 316 (Ecotronic) (E30)  
 M10 B18 (184VA) 316 (E21)  
 M10 B18 (184VB) 316 (E30)  
 M10 B18 (184VC) 318 (E21)  
 M10 B18 (184VD) 318 (E30)  
 M10 B18 (184VU) 318 i (E21)  
 M10 B18 (320US) 320 i (E21)  
 518 (E12)  
 518 (E28)  
 518 i (E28)















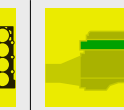

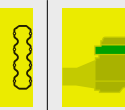
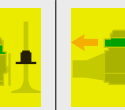
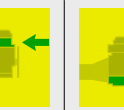









											
	<b>02-24190-18</b> 11 12 9 065 718	<b>08-19737-03</b> 11 11 1 734 114	<b>15-19747-01</b> 	<b>61-24190-60</b> 11 12 1 734 279 90 Ø 1,5 mm	<b>14-32000-01</b> 11 12 0 621 144 (10x)	<b>71-19738-50</b> 11 12 1 734 276	<b>12-21025-01</b> 11 34 1 256 556 (8x)	<b>71-19741-10</b>  11 61 1 734 436	<b>71-19737-20</b> 11 13 1 727 974	<b>81-19866-10</b>  11 14 1 709 632 35x55 A SL RD ACM	
				<b>61-24190-70</b> 11 12 1 734 280 90 Ø 1,8 mm				<b>71-19742-20</b>  11 61 1 734 435		<b>81-20745-40</b>  11 14 2 245 364 90x110 A SL LD FPM	
							<b>70-21025-00</b> 11 34 1 256 556	<b>71-28708-10</b>  11 62 1 723 838	<b>71-21007-30</b>  18 11 1 728 363		

1,8 M10 B18 (184EA) 75-77 kW (102-105 PS) 316 i (E30) 09/82-06/90  
 M10 B18 (184EB) 318 i (E30)  
 M10 B18 (184EZ)  
 M10 B18 (184KA)

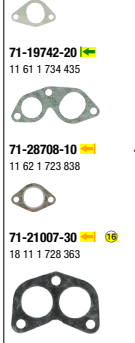









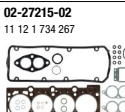
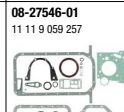
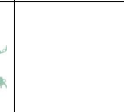
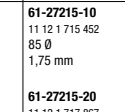
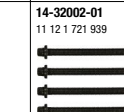
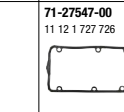
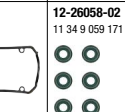
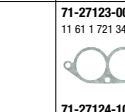
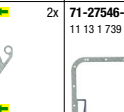
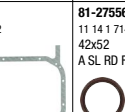
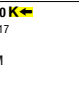

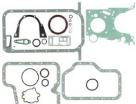

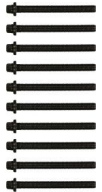
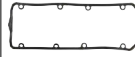
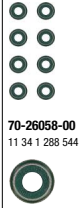

											
	<b>02-24190-27</b> 11 12 1 734 142	<b>08-19737-03</b> 11 11 1 734 114	<b>15-19747-01</b> 	<b>61-24190-60</b> 11 12 1 734 279 90 Ø 1,5 mm	<b>14-32000-01</b> 11 12 0 621 144 (10x)	<b>71-19738-50</b> 11 12 1 734 276	<b>12-21025-01</b> 11 34 1 256 556 (8x)	<b>71-19741-10</b>  11 61 1 734 436	<b>71-19737-20</b> 11 13 1 727 974	<b>81-19866-10</b>  11 14 1 709 632 35x55 A SL RD ACM	
				<b>61-24190-70</b> 11 12 1 734 280 90 Ø 1,8 mm				<b>71-19742-20</b>  11 61 1 734 435		<b>81-20745-40</b>  11 14 2 245 364 90x110 A SL LD FPM	
							<b>70-21025-00</b> 11 34 1 256 556	<b>71-28708-10</b>  11 62 1 723 838	<b>71-21007-30</b>  18 11 1 728 363		

BMW

Ltr.  M118  66-96 kW (90-131 PS)  1













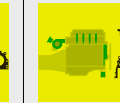
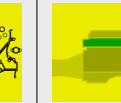
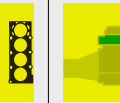
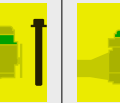
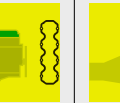
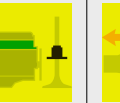
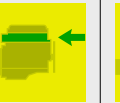



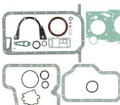

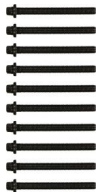

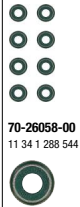





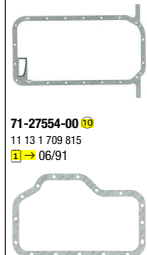

											
		<p><b>08-19737-03</b> 11 11 1 734 114</p> 	<p><b>15-19747-01</b> </p> <p>11 14 1 727 986</p> 	<p><b>61-24190-60</b> 11 12 1 734 279 90 Ø 1,5 mm</p> <p><b>61-24190-70</b> 11 12 1 734 280 90 Ø 1,8 mm</p> 	<p><b>14-32000-01</b> 11 12 0 621 144 (10x)</p> 	<p><b>71-19738-50</b> 11 12 1 734 276</p> 	<p><b>12-21025-01</b> 11 34 1 256 556 (8x)</p> <p><b>70-21025-00</b> 11 34 1 256 556</p> 	<p><b>71-19741-10</b>  3x 11 61 1 734 436</p> <p><b>71-19742-20</b>  11 61 1 734 435</p> <p><b>71-28708-10</b>  4x 11 62 1 723 838</p> <p><b>71-21007-30</b>   18 11 1 728 363</p> 	<p><b>71-19737-20</b> 11 13 1 727 974</p> 	<p><b>81-19866-10</b>  11 14 1 709 632 35x55 A SL RD ACM</p> <p><b>81-18304-00</b>  11 14 1 255 015 80x100 A LD MVQ</p> <p><b>81-20745-40</b>  11 14 2 245 364 90x110 A SL LD FPM</p> 	

1,8 M40 B18 C M40 B18 (184E1) 83-103 kW (113-140 PS) 318 i (E30) 06/87











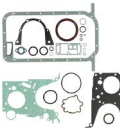

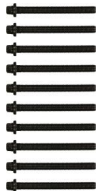

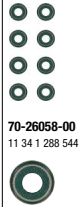





											
	<p><b>02-27215-02</b> 11 12 1 734 267</p> 	<p><b>08-27546-01</b> 11 11 9 059 257</p> 	<p><b>61-27215-10</b> 11 12 1 715 452 85 Ø 1,75 mm</p> <p><b>61-27215-20</b> 11 12 1 717 867 85 Ø 2,05 mm</p> 	<p><b>14-32002-01</b> 11 12 1 721 939</p> 	<p><b>71-27547-00</b> 11 12 1 727 726</p> 	<p><b>12-26058-02</b> 11 34 9 059 171</p> <p><b>70-26058-00</b> 11 34 1 288 544</p> 	<p><b>71-27123-00</b>  2x 11 61 1 721 346</p> <p><b>71-27124-10</b>  11 61 1 734 683</p> <p><b>71-31334-00</b>  11 62 1 743 719</p> <p><b>71-27267-00</b>   11 76 1 711 968</p> 	<p><b>71-27546-10</b> 11 13 1 739 592</p>  <p><b>71-27554-00</b>  11 13 1 709 815</p> 	<p><b>81-27556-00</b>  11 14 1 714 617 42x52 A SL RD FPM</p> <p><b>81-20745-40</b>  11 14 2 245 364 90x110 A SL LD FPM</p> <p><b>81-24641-10</b> <b>N</b> 11 12 1 285 609 38x50 A SL FPM</p> 		

BMW

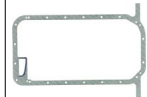
Ltr.  1,8 M40 B18 (184E1) 83 kW (113 PS) 318i (E30) 04/89-06/94

											
	<p><b>02-27215-02</b> 11 12 1 734 267</p> 	<p><b>08-27546-01</b> 11 11 9 059 257 1 → 06/91</p> 		<p><b>61-27215-10</b> 11 12 1 715 452 85 Ø 1,75 mm</p> <p><b>61-27215-20</b> 11 12 1 717 867 85 Ø 2,05 mm</p> 	<p><b>14-32002-01</b> 11 12 1 721 939</p> 	<p><b>71-27547-00</b> 11 12 1 727 726</p> 	<p><b>12-26058-02</b> 11 34 9 059 171</p> 	<p><b>71-27123-00</b>  2x 11 61 1 721 346</p>  <p><b>71-27124-10</b>  11 61 1 734 683</p>  <p><b>71-31334-00</b>  11 62 1 743 719</p>  <p><b>71-27267-00</b>   11 76 1 711 968</p> 	<p><b>71-27546-10</b> 11 13 1 739 592</p>  <p><b>71-27554-00</b>  11 13 1 709 815 1 → 06/91</p> 	<p><b>81-27556-00</b>  11 14 1 714 617 42x52 A SL RD FPM</p>  <p><b>81-20745-40</b>  11 14 2 245 364 90x110 A SL LD FPM</p>  <p><b>81-24641-10</b> <b>N</b> 11 12 1 285 609 38x50 A SL FPM</p> 	

1,8 M40 B18 (184E1) 83 kW (113 PS) 318i (E36) 09/89-06/94  
518i (E34)



	<p><b>02-27215-02</b> 11 12 1 734 267</p> 	<p><b>08-27546-03</b> 11 11 1 734 268</p> 		<p><b>61-27215-10</b> 11 12 1 715 452 85 Ø 1,75 mm</p> <p><b>61-27215-20</b> 11 12 1 717 867 85 Ø 2,05 mm</p> 	<p><b>14-32002-01</b> 11 12 1 721 939</p> 	<p><b>71-27547-00</b> 11 12 1 727 726</p> 	<p><b>12-26058-02</b> 11 34 9 059 171</p> 	<p><b>71-27123-00</b>  2x 11 61 1 721 346</p>  <p><b>71-27124-10</b>  11 61 1 734 683</p>  <p><b>71-31334-00</b>  11 62 1 743 719</p>  <p><b>71-27267-00</b>   11 76 1 711 968</p> 	<p><b>71-27546-10</b> 11 13 1 739 592</p> 	<p><b>81-27556-00</b>  11 14 1 714 617 42x52 A SL RD FPM</p>  <p><b>81-20745-40</b>  11 14 2 245 364 90x110 A SL LD FPM</p>  <p><b>81-24641-10</b> <b>N</b> 11 12 1 285 609 38x50 A SL FPM</p> 
--	---	--	--	---	---	---	---	---	---	--

















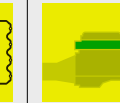
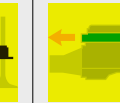
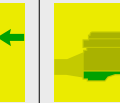
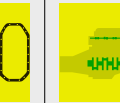
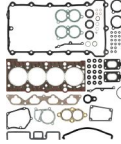

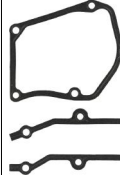

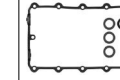
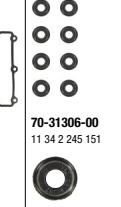







BMW

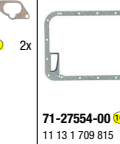

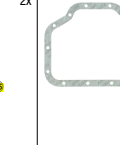







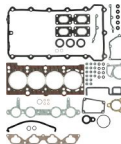

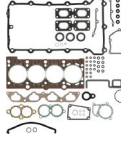

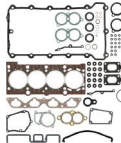

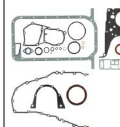

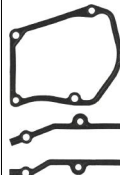
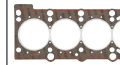

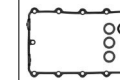

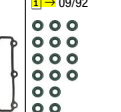

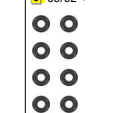













Ltr.																	
1,8	M40 B18 (184E1)	83 kW (113 PS)	518 i (E34)	04/93-04/94		<b>02-27215-02</b> 11 12 1 734 267 	<b>08-27546-03</b> 11 11 1 734 268 		<b>61-27215-10</b> 11 12 1 715 452 85 Ø 1,75 mm  <b>61-27215-20</b> 11 12 1 717 867 85 Ø 2,05 mm 	<b>14-32002-01</b> 11 12 1 721 939 	<b>71-27547-00</b> 11 12 1 727 726 	<b>12-26058-02</b> 11 34 9 059 171  <b>70-26058-00</b> 11 34 1 288 544 	<b>71-27123-00</b> 2x 11 61 1 721 346  <b>71-27124-10</b>	<b>71-27546-10</b> 11 13 1 739 592 	<b>81-27556-00</b>	<b>81-20745-40</b>	<b>81-24641-10</b> <b>N</b> 11 12 1 285 609 38x50 A SL FPM 
1,8	M42 B18 (184S1)	100 kW (136 PS)	318 is (E30)	09/89-08/91		<b>02-28485-01</b> 11 12 9 063 333 	<b>08-27546-02</b> 11 11 1 727 595 	<b>15-31356-01</b>	<b>61-28485-00</b> 11 12 1 721 546 85 Ø 1,74 mm 	<b>14-32002-01</b> 11 12 1 721 939 	<b>15-28484-01</b> 11 12 1 721 876 +11 12 1 721 475 +11 12 1 721 476 (3x) 	<b>12-26058-03</b> 11 34 9 059 171 (2x)  <b>70-26058-00</b> 11 34 1 288 544 	<b>71-28491-10</b>	<b>71-27546-10</b> 11 13 1 739 592 	<b>81-28498-00</b>	<b>81-20745-40</b>	<b>81-24641-10</b> <b>N</b> 11 12 1 285 609 38x50 A SL FPM 
1,8	M42 B18 (184S1)	103 kW (140 PS)	318 i (E36)	01/94-12/95		<b>02-28485-02</b> 11 12 9 065 439 01/94  <b>02-28485-03</b> 11 12 9 066 434 02/94 → 	<b>08-27546-02</b> 11 11 1 727 595 01/94  <b>08-27546-06</b> 11 11 9 066 436 02/94 → 	<b>15-31356-01</b>	<b>61-28485-00</b> 11 12 1 721 546 85 Ø 1,74 mm 	<b>14-32002-01</b> 11 12 1 721 939 	<b>15-28484-01</b> 11 12 1 721 876 +11 12 1 721 475 +11 12 1 721 476 (3x) 	<b>12-31306-07</b> 11 34 9 065 438  <b>70-31306-00</b> 11 34 2 245 151 	<b>71-28491-10</b>	<b>71-27546-10</b> 11 13 1 739 592 	<b>81-28498-00</b>	<b>81-20745-40</b>	<b>81-24641-10</b> <b>N</b> 11 12 1 285 609 38x50 A SL FPM 

BMW

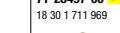
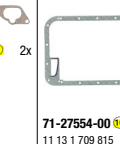
Ltr.  M42 B18 (184S1) 103 kW (140 PS) 318 i (E36) 318 is (E36) 02/92-12/95 

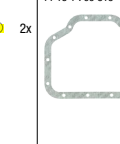













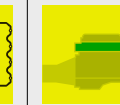
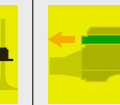
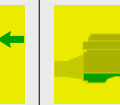

										
	<p><b>02-28485-03</b> 11 12 9 066 434</p> 	<p><b>08-27546-06</b> 11 11 9 066 436</p> 	<p><b>15-31356-01</b> </p> <p>11 14 1 247 429</p> 	<p><b>61-28485-00</b> 11 12 1 721 546 85 Ø 1,74 mm</p> 	<p><b>14-32002-01</b> 11 12 1 721 939</p> 	<p><b>15-28484-01</b> 11 12 1 721 876 +11 12 1 721 475 +11 12 1 721 476 (3x)</p> 	<p><b>12-31306-07</b> 11 34 9 065 438</p> 	<p>2x <b>71-28491-10</b> </p> <p>11 61 1 734 684</p>  <p><b>71-29365-00</b>   2x</p> <p>11 61 1 739 545</p>  <p><b>71-28494-00</b>  2x</p> <p>11 62 1 728 983</p>  <p><b>71-28497-00</b>  </p> <p>18 30 1 711 969</p> 	<p><b>71-27546-10</b> 11 13 1 739 592</p>  <p><b>71-27554-00</b> </p> <p>11 13 1 709 815</p> 	<p><b>81-28498-00 K</b> </p> <p>11 14 1 435 848 44x60 A SL RD FPM</p>  <p><b>81-20745-40 K</b> </p> <p>11 14 2 245 364 90x110 A SL LD FPM</p> 

1,8 M42 B18 (184S1) 103 kW (140 PS) 318 is (E36) 01/92-12/95













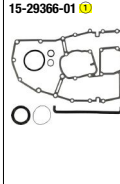
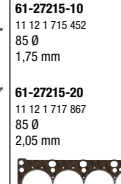

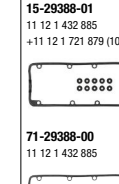
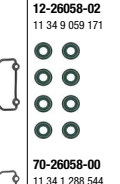
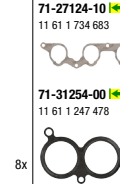
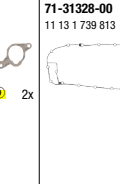

	<p><b>02-28485-01</b> 11 12 9 063 333  09/92</p>  <p><b>02-28485-02</b> 11 12 9 065 439  09/92 →  09/93</p>  <p><b>02-28485-03</b> 11 12 9 066 434  09/93 →</p> 	<p><b>08-27546-02</b> 11 11 1 727 595  09/93</p> <p><b>08-27546-06</b> 11 11 9 066 436  09/93 →</p> 	<p><b>15-31356-01</b> </p> <p>11 14 1 247 429</p> 	<p><b>61-28485-00</b> 11 12 1 721 546 85 Ø 1,74 mm</p> 	<p><b>14-32002-01</b> 11 12 1 721 939</p> 	<p><b>15-28484-01</b> 11 12 1 721 876 +11 12 1 721 475 +11 12 1 721 476 (3x)</p> 	<p><b>12-26058-03</b> 11 34 9 059 171 (2x)  09/92</p>  <p><b>12-31306-07</b> 11 34 9 065 438  09/92 →</p>  <p><b>70-26058-00</b> 11 34 1 288 544  09/92</p>  <p><b>70-31306-00</b> 11 34 2 245 151  09/92 →</p> 	<p>2x <b>71-28491-10</b> </p> <p>11 61 1 734 684</p>  <p><b>71-29361-10</b>   2x</p> <p>11 61 1 734 490  09/93</p>  <p><b>71-29365-00</b>   2x</p> <p>11 61 1 739 545  09/93 →</p>  <p><b>71-28494-00</b>  2x</p> <p>11 62 1 728 983</p>  <p><b>71-28497-00</b>  </p> <p>18 30 1 711 969</p> 	<p><b>71-27546-10</b> 11 13 1 739 592</p>  <p><b>71-27554-00</b> </p> <p>11 13 1 709 815</p> 	<p><b>81-28498-00 K</b> </p> <p>11 14 1 435 848 44x60 A SL RD FPM</p>  <p><b>81-20745-40 K</b> </p> <p>11 14 2 245 364 90x110 A SL LD FPM</p> 
--	--	---	--	--	---	--	---	---	--	--

**BMW**













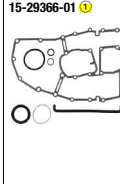
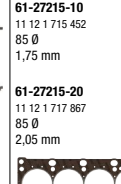

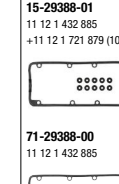
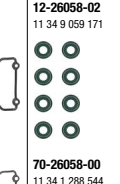
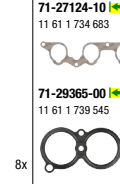
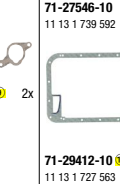
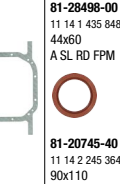
Ltr.  1,8 M42 B18 (184S1) 103 kW (140 PS) 318 ti (E36) 09/94-12/95

											
	<b>02-28485-03</b> 11 12 9 066 434	<b>08-27546-06</b> 11 11 9 066 436	<b>15-31356-01</b>  11 14 1 247 429	<b>61-28485-00</b> 11 12 1 721 546 85 Ø 1,74 mm	<b>14-32002-01</b> 11 12 1 721 939	<b>15-28484-01</b> 11 12 1 721 876 +11 12 1 721 475 +11 12 1 721 476 (3x)	<b>12-31306-07</b> 11 34 9 065 438  <b>70-31306-00</b> 11 34 2 245 151	2x <b>71-28491-10</b>  11 61 1 734 684  <b>71-28494-00</b>  11 62 1 728 983  <b>71-28497-00</b>   18 30 1 711 969	<b>71-27546-10</b> 11 13 1 739 592	<b>81-28498-00</b>  11 14 1 435 848 44x60 A SL RD FPM  <b>81-20745-40</b>  11 14 2 245 364 90x110 A SL LD FPM	



1,8 M43 B18 (184E2) 85 kW (115 PS) 518 g (E34) 02/96-07/96



















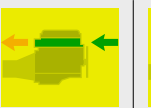

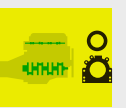
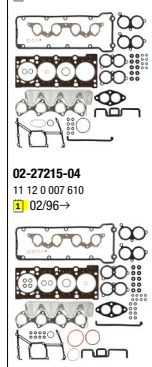
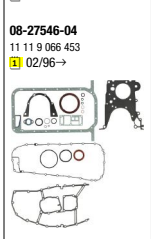

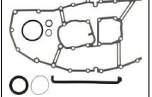
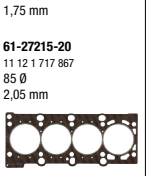
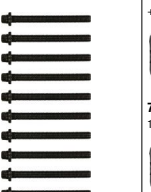
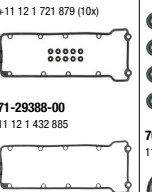
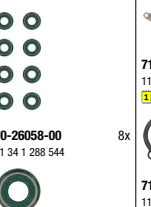





											
	<b>02-27215-04</b> 11 12 0 007 610	<b>08-27546-04</b> 11 11 9 066 453	<b>15-29366-01</b>  11 14 1 247 429	<b>61-27215-10</b> 11 12 1 715 452 85 Ø 1,75 mm  <b>61-27215-20</b> 11 12 1 717 867 85 Ø 2,05 mm	<b>14-32002-01</b> 11 12 1 721 939	<b>15-29388-01</b> 11 12 1 432 885 +11 12 1 721 879 (10x)  <b>71-29388-00</b> 11 12 1 432 885	<b>12-26058-02</b> 11 34 9 059 171  <b>70-26058-00</b> 11 34 1 288 544	8x <b>71-27124-10</b>  11 61 1 734 683  <b>71-31254-00</b>   11 61 1 247 478  <b>71-31334-00</b>  11 62 1 743 719  <b>71-28497-00</b>   18 30 1 711 969	<b>71-31328-00</b> 11 13 1 739 813	<b>81-28498-00</b>  11 14 1 435 848 44x60 A SL RD FPM  <b>81-20745-40</b>  11 14 2 245 364 90x110 A SL LD FPM	

1,8 M43 B18 (184E2) 85 kW (115 PS) 518 i (E34) 05/94-08/95

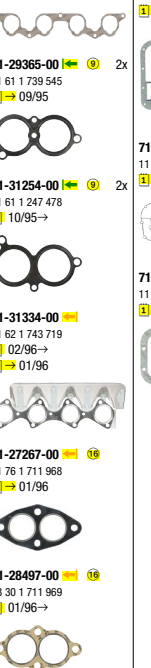

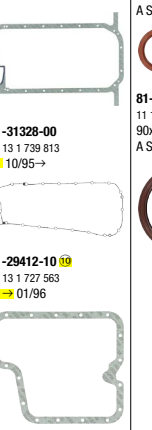



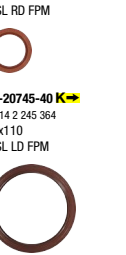



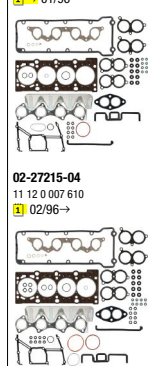
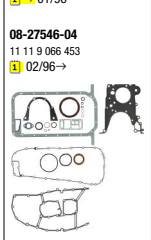

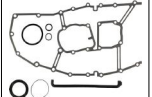
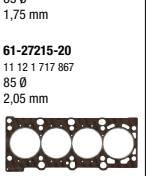
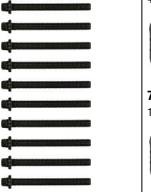
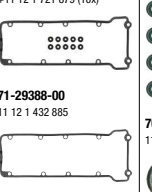
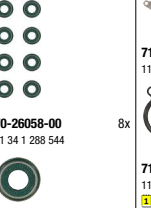



											
	<b>02-27215-03</b> 11 12 9 066 452	<b>08-27546-05</b> 11 11 9 066 931	<b>15-29366-01</b>  11 14 1 247 429	<b>61-27215-10</b> 11 12 1 715 452 85 Ø 1,75 mm  <b>61-27215-20</b> 11 12 1 717 867 85 Ø 2,05 mm	<b>14-32002-01</b> 11 12 1 721 939	<b>15-29388-01</b> 11 12 1 432 885 +11 12 1 721 879 (10x)  <b>71-29388-00</b> 11 12 1 432 885	<b>12-26058-02</b> 11 34 9 059 171  <b>70-26058-00</b> 11 34 1 288 544	8x <b>71-27124-10</b>  11 61 1 734 683  <b>71-29365-00</b>   11 61 1 739 545  <b>71-31334-00</b>  11 62 1 743 719  <b>71-28497-00</b>   11 76 1 711 968	<b>71-27546-10</b> 11 13 1 739 592	<b>81-28498-00</b>  11 14 1 435 848 44x60 A SL RD FPM  <b>81-20745-40</b>  11 14 2 245 364 90x110 A SL LD FPM	

BMW

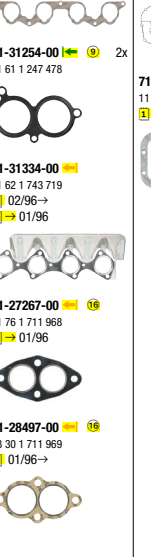
Ltr.      
 1,8 M43 B18 (184E2) 85 kW (115-116 PS) 318 i (E36) 518 i (E34) 09/93-11/99

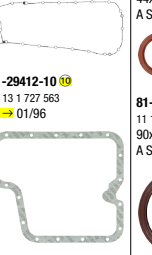
										
	<p><b>02-27215-03</b> 11 12 9 066 452 <b>1</b> → 01/96</p> <p><b>08-27546-04</b> 11 11 9 066 453 <b>1</b> 02/96 →</p> <p><b>02-27215-04</b> 11 12 0 007 610 <b>1</b> 02/96 →</p> 	<p><b>08-27546-05</b> 11 11 9 066 931 <b>1</b> → 01/96</p> <p><b>08-27546-04</b> 11 11 9 066 453 <b>1</b> 02/96 →</p> 	<p><b>15-29366-01</b> </p> 	<p><b>61-27215-10</b> 11 12 1 715 452 85 Ø 1,75 mm</p> <p><b>61-27215-20</b> 11 12 1 717 867 85 Ø 2,05 mm</p> 	<p><b>14-32002-01</b> 11 12 1 721 939</p> 	<p><b>15-29388-01</b> 11 12 1 432 885 +11 12 1 721 879 (10x)</p> <p><b>71-29388-00</b> 11 12 1 432 885</p> 	<p><b>12-26058-02</b> 11 34 9 059 171</p> <p><b>70-26058-00</b> 11 34 1 288 544</p> 	<p><b>71-27124-10</b> </p> <p>11 61 1 734 883</p> <p><b>71-29365-00</b>   2x 11 61 1 739 545 <b>1</b> → 09/95</p> <p><b>71-31254-00</b>   2x 11 61 1 247 478 <b>1</b> 10/95 →</p> <p><b>71-31334-00</b> 11 62 1 743 719 <b>1</b> 02/96 → <b>1</b> → 01/96</p> <p><b>71-27267-00</b>   11 76 1 711 968 <b>1</b> → 01/96</p> <p><b>71-28497-00</b>   18 30 1 711 969 <b>1</b> 01/96 →</p> 	<p><b>71-27546-10</b> 11 13 1 739 592 <b>1</b> → 09/95</p> <p><b>71-31328-00</b> 11 13 1 739 813 <b>1</b> 10/95 →</p> <p><b>71-29412-10</b>  11 13 1 727 563 <b>1</b> → 01/96</p> 	<p><b>81-28498-00</b>   11 14 1 435 848 44x60 A SL RD FPM</p> <p><b>81-20745-40</b>   11 14 2 245 364 90x110 A SL LD FPM</p> 

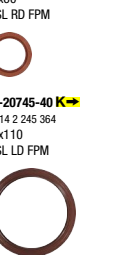

1,8 M43 B18 (184E2) 85 kW (116 PS) Z3 1.8 (E36) 10/95-10/98

	<p><b>02-27215-03</b> 11 12 9 066 452 <b>1</b> → 01/96</p> <p><b>08-27546-04</b> 11 11 9 066 453 <b>1</b> 02/96 →</p> <p><b>02-27215-04</b> 11 12 0 007 610 <b>1</b> 02/96 →</p> 	<p><b>08-27546-05</b> 11 11 9 066 931 <b>1</b> → 01/96</p> <p><b>08-27546-04</b> 11 11 9 066 453 <b>1</b> 02/96 →</p> 	<p><b>15-29366-01</b> </p> 	<p><b>61-27215-10</b> 11 12 1 715 452 85 Ø 1,75 mm</p> <p><b>61-27215-20</b> 11 12 1 717 867 85 Ø 2,05 mm</p> 	<p><b>14-32002-01</b> 11 12 1 721 939</p> 	<p><b>15-29388-01</b> 11 12 1 432 885 +11 12 1 721 879 (10x)</p> <p><b>71-29388-00</b> 11 12 1 432 885</p> 	<p><b>12-26058-02</b> 11 34 9 059 171</p> <p><b>70-26058-00</b> 11 34 1 288 544</p> 	<p><b>71-27124-10</b> </p> <p>11 61 1 734 883</p> <p><b>71-31254-00</b>   2x 11 61 1 247 478</p> <p><b>71-31334-00</b> 11 62 1 743 719 <b>1</b> 02/96 → <b>1</b> → 01/96</p> <p><b>71-27267-00</b>   11 76 1 711 968 <b>1</b> → 01/96</p> <p><b>71-28497-00</b>   18 30 1 711 969 <b>1</b> 01/96 →</p> 	<p><b>71-31328-00</b> 11 13 1 739 813</p> <p><b>71-29412-10</b>  11 13 1 727 563 <b>1</b> → 01/96</p> 	<p><b>81-28498-00</b>   11 14 1 435 848 44x60 A SL RD FPM</p> <p><b>81-20745-40</b>   11 14 2 245 364 90x110 A SL LD FPM</p> 
--	---	---	--	--	--	---	--	--	---	---

BMW

Ltr.														
1,8	N42 B18 A N46 B18 A	85 kW (115 PS)	316 i (E46) 316 ti (E46)	06/01-02/05		 <b>02-37293-01</b> 11 12 0 308 857	 <b>08-34056-01</b> 11 11 7 511 529	 <b>61-36255-00</b> 11 12 7 509 710 0,4 mm MLS  <b>61-36255-10</b> 11 12 7 509 711 0,7 mm MLS	 <b>14-32314-01</b> 11 12 7 511 534	 <b>15-37293-01</b> 11 12 0 032 224	 <b>12-37281-01</b> 11 34 0 054 492	 <b>11-37282-01</b> 11 61 7 530 703	 <b>71-34056-00</b> 11 13 7 511 224	 <b>81-34057-00</b> 11 11 7 547 842 65x79 A SL RD PTFE ACM  <b>81-20745-00</b> 11 14 2 249 533 90x110 AB SL LD PTFE (Polytetrafluorethylen)/ACM (Polyacryl-Kautschuk)
1,9	M43 B19 (194E1)	77-87 kW (105-118 PS)	Z3 1.9 (E36) 316 i (E36) 316 i (E46) 318 Ci (E46) 318 i (E46)	07/98-01/03	 <b>02-34910-01</b> 11 12 1 712 309	 <b>08-33139-01</b> 11 11 1 712 981	 <b>15-29366-01</b>  <b>61-34910-00</b> 11 12 1 708 585 86 Ø 1,74 mm  <b>61-34910-10</b> 11 12 1 708 606 86 Ø 2,1 mm	 <b>14-32002-01</b> 11 12 1 721 939	 <b>15-29388-01</b> 11 12 1 432 885 +11 12 1 721 879 (10x)	 <b>12-26058-02</b> 11 34 9 059 171	 <b>71-33179-00</b> 11 61 1 437 384	 <b>71-33139-00</b> 11 13 1 432 109	 <b>81-28498-00</b> 11 14 1 435 848 44x60 A SL RD FPM  <b>81-20745-40</b> 11 14 2 245 364 90x110 A SL LD FPM	
1,9	M43 B19 (194E1)	87 kW (118 PS)	318 i (E46)	12/97-09/01	 <b>02-34910-01</b> 11 12 1 712 309	 <b>08-33139-01</b> 11 11 1 712 981	 <b>15-29366-01</b>  <b>61-34910-00</b> 11 12 1 708 585 86 Ø 1,74 mm  <b>61-34910-10</b> 11 12 1 708 606 86 Ø 2,1 mm	 <b>14-32002-01</b> 11 12 1 721 939	 <b>15-29388-01</b> 11 12 1 432 885 +11 12 1 721 879 (10x)	 <b>12-26058-02</b> 11 34 9 059 171	 <b>71-33179-00</b> 11 61 1 437 384	 <b>71-33139-00</b> 11 13 1 432 109	 <b>81-28498-00</b> 11 14 1 435 848 44x60 A SL RD FPM  <b>81-20745-40</b> 11 14 2 245 364 90x110 A SL LD FPM	

BMW

Ltr.  1,9 M44 B19 (194S1) 103 kW (140 PS) Z3 1.9 i (E36) 318 is (E36) 318 ti (E36) 09/95-08/99 



1,9 M44 B19 (194S1) 103 kW (140 PS) Z3 1.9 i (E36) 318 is (E36) 318 ti (E36) 09/95-08/99



**02-31240-01**  
11 12 1 743 375  
 09/96



**02-31240-02**  
11 12 9 070 615  
 10/96→

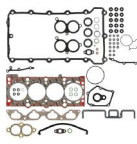

**08-31328-01**  
11 11 1 743 981



**15-31256-01**   
11 14 1 743 065

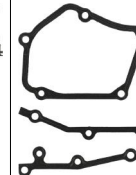

**15-31329-01**   
11 14 1 432 099

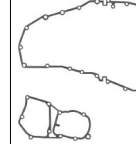

**61-31240-00**  
11 12 1 739 849  
86 Ø  
1,74 mm



**14-32002-01**  
11 12 1 721 939

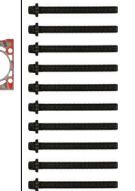

**15-28484-01**  
11 12 1 721 876  
+11 12 1 721 475  
+11 12 1 721 476 (3x)

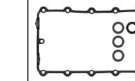

**12-31306-12**  
11 34 9 063 193

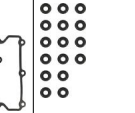



**70-31306-00**  
11 34 2 245 151



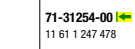

**71-28491-10**   
11 61 1 734 684





**71-31254-00**   2x  
11 61 1 247 478







**71-28494-00**  2x  
11 62 1 728 983







**71-31589-00**   
11 62 1 435 366



**71-27467-00**    
11 76 1 711 717  
 09/96



**71-28497-00**    
18 30 1 711 969  
 10/96→



**71-31328-00**  
11 13 1 739 813



**81-28498-00**   
11 14 1 435 848  
44x60  
A SL RD FPM



**81-20745-40**   
11 14 2 245 364  
90x110  
A SL LD FPM



1,9 M44 B19 (194S1) 103 kW (140 PS) Z3 1.9 i (E36) 318 is (E36) 01/96-09/99



**02-31240-02**  
11 12 9 070 615



**08-31328-01**  
11 11 1 743 981



**15-31256-01**   
11 14 1 743 065

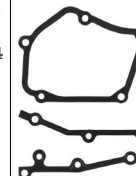

**15-31329-01**   
11 14 1 432 099

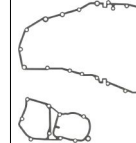

**61-31240-00**  
11 12 1 739 849  
86 Ø  
1,74 mm



**14-32002-01**  
11 12 1 721 939

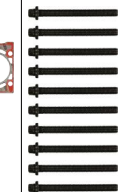

**15-28484-01**  
11 12 1 721 876  
+11 12 1 721 475  
+11 12 1 721 476 (3x)

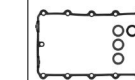

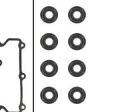

**12-31306-07**  
11 34 9 065 438





**70-31306-00**  
11 34 2 245 151





2x **71-28491-10**   
11 61 1 734 684





**71-31254-00**   2x  
11 61 1 247 478



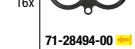



**71-28494-00**  2x  
11 62 1 728 983  
 09/96



**71-31589-00**   
11 62 1 435 366  
 10/96→



**71-28497-00**    
18 30 1 711 969  
 09/96



**71-31328-00**  
11 13 1 739 813









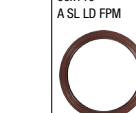













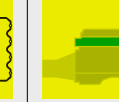
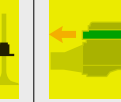





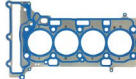

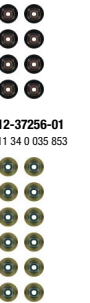















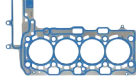

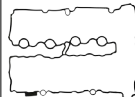





**81-28498-00**   
11 14 1 435 848  
44x60  
A SL RD FPM



**81-20745-40**   
11 14 2 245 364  
90x110  
A SL LD FPM



BMW

Ltr.															
2,0	B46 A20 B B48 A20 A	131-170 kW (178-231 PS)	X1 sDrive (F48) X1 xDrive (F48) X2 sDrive 20 i (F39) X2 xDrive 20 i (F39) 120 i (F40) 220 i (F44) 220 i (F45) 220 i (F46) 220 i xDrive (F44) 228 i xDrive (F44)	03/18					<p><b>61-10166-00</b> 11 12 7 934 596 83 Ø 0,8 mm MLS</p> <p><b>61-10166-10</b> 11 12 7 934 597 83 Ø 1,1 mm MLS</p> 	<p><b>14-12261-02</b> 11 12 7 613 127 (10X)</p> 	<p><b>71-17437-00</b> 11 12 8 638 247</p> 	<p><b>12-36866-03</b> 11 34 0 038 719</p>  <p><b>12-37256-01</b> 11 34 0 035 853</p>  <p><b>70-36866-00</b> 11 34 7 539 918</p> 	<p><b>71-11403-00</b>  4x 11 61 7 633 493</p>  <p><b>71-11394-00</b>  11 62 7 617 523</p> 	<p><b>70-31414-10</b></p> 	<p><b>81-37002-00</b>  11 11 8 604 931 55x68 AB RD PTFE</p>  <p><b>81-10448-00</b>  11 14 8 602 594 90x104 LD PTFE ACM</p> 
2,0	B46 A20 B	170 kW (231 PS)	X1 sDrive 28 i (F48)	11/14				<p><b>61-38195-00</b> 11 12 8 627 107 83 Ø 0,7 mm MLS  ⇒ 06/15</p> <p><b>61-38195-10</b> 11 12 8 627 108 83 Ø 1 mm MLS  ⇒ 06/15</p> 	<p><b>14-12261-02</b> 11 12 7 613 127 (10X)</p> 	<p><b>71-11411-00</b> 11 12 8 618 519</p> 	<p><b>12-36866-03</b> 11 34 0 038 719</p>  <p><b>12-37256-03</b> 11 34 0 038 720</p>  <p><b>70-36866-00 ES</b> 8x 11 34 7 539 918</p>  <p><b>70-37256-00 AS</b> 8x 11 34 7 573 689</p> 	<p><b>71-11403-00</b>  4x 11 61 7 633 493</p>  <p><b>71-11404-00</b>   11 61 7 633 558</p>  <p><b>71-11394-00</b>  11 62 7 617 523</p> 	<p><b>81-37002-00</b>  11 11 8 604 931 55x68 AB RD PTFE</p>  <p><b>81-10448-00</b>  11 14 8 602 594 90x104 LD PTFE ACM</p> 		



BMW														
Ltr.														
2,0	B46 A20 B	170 kW (231 PS)	X1 xDrive 25 i (F48) X2 sDrive 28 i (F39) X2 xDrive 28 i (F39)	07/15										
					<b>61-10076-00</b> 11 12 8 654 272 82 Ø 0,7 mm MLS  <b>61-10076-10</b> 11 12 8 654 273 82 Ø 1 mm MLS  	<b>14-12261-02</b> 11 12 7 613 127 (10X)  	<b>71-11411-00</b> 11 12 8 618 519  	<b>12-36866-03</b> 11 34 0 038 719    <b>12-37256-03</b> 11 34 0 038 720    <b>70-36866-00 ES</b> 8x 11 34 7 539 918  <b>70-37256-00 AS</b> 8x 11 34 7 573 689  	<b>70-31414-10</b>   <b>71-11403-00</b> 4x 11 61 7 633 493    <b>71-11394-00</b> 11 62 7 617 523  	<b>70-31414-10</b>   	<b>81-37002-00 K</b> 11 11 8 604 931 55x68 AB RD PTFE    <b>81-10448-00 K</b> 11 14 8 602 594 90x104 LD PTFE ACM    			
2,0	B46 B20 B B48 B20 A B48 B20 B	100-215 kW (136-292 PS)	X3 xDrive 20 i (G01) X3 xDrive 20 i (G01, F97) X3 xDrive 30 e Plug-in-Hybrid (G01, F97) X3 xDrive 30 i Mild-Hybrid (G01, F97) X4 xDrive 20 i (G02, F98) X4 xDrive 20 i Mild-Hybrid (G02, F98) 120 i (F20) 120 i (F21) 218 i (F23) 218 i (G42, G87) 220 i (G42, G87) 225 i (F22, F87) 225 i (F23) 230 i (F22, F87) 230 i (F23) 230 i xDrive (F22, F87) 320 i (F34) 320 i (G21) 320 i (G21, G81) 320 i xDrive (F34) 330 e xDrive (G20, G80, G28) 330 i (F30, F80) 330 i xDrive (F34) 420 i (F32, F82) 420 i (F33, F83) 420 i (F36) 420 i xDrive (F32, F82) 420 i xDrive (F36) 520 i (G30, F90) 520 i (G31) 530 e (G30, F90) 530 e xDrive (G30, F90)	07/15		<b>02-11411-01</b>  	<b>61-10076-00</b> 11 12 8 654 272 82 Ø 0,7 mm MLS  <b>61-10076-10</b> 11 12 8 654 273 82 Ø 1 mm MLS  	<b>14-12261-02</b> 11 12 7 613 127 (10X)  	<b>71-11411-00</b> 11 12 8 618 519  	<b>12-36866-03</b> 11 34 0 038 719    <b>12-37256-01</b> 11 34 0 035 853  	<b>71-12439-00</b> 4x 11 61 8 637 800    <b>71-11394-00</b> 11 62 7 617 523  	<b>70-31414-10</b>   	<b>81-37002-00 K</b> 11 11 8 604 931 55x68 AB RD PTFE    <b>81-10448-00 K</b> 11 14 8 602 594 90x104 LD PTFE ACM    	



BMW

Ltr.	Motor	Power	Model	Year	Head Gasket	Head Gasket	Head Gasket	Head Gasket	Head Gasket	Head Gasket	Head Gasket	Head Gasket	Head Gasket	Head Gasket	Head Gasket	Head Gasket
2,0	B46 B20 B B48 B20 B	135-180 kW (184-245 PS)	X3 xDrive 20 i (G01) X3 xDrive 20 i (G01, F97) X3 xDrive 30 i Mild-Hybrid (G01, F97) X4 xDrive 20 i Mild-Hybrid (G02, F98)	12/17 <b>[NEW]</b>												
					02-11411-01				61-10166-00 11 12 7 934 596 83 Ø 0,8 mm MLS	14-13082-01 11 12 8 644 675 (10X)	71-17437-00 11 12 8 638 247	12-36866-03 11 34 0 038 719	71-17375-00 11 61 9 486 362	4x	70-31414-10 	81-37002-00 11 11 8 604 931 55x68 AB RD PTFE
									61-10166-10 11 12 7 934 597 83 Ø 1,1 mm MLS				71-20960-00 11 65 8 631 900			81-10448-00 11 14 8 602 594 90x104 LD PTFE ACM
2,0	B46 B20 B	185 kW (252 PS)	X3 xDrive 30 i (G01, F97) 530 i (G30) 530 i xDrive (G30, F90)	09/16					61-10076-00 11 12 8 654 272 82 Ø 0,7 mm MLS	14-13082-01 11 12 8 644 675 (10X)	71-11411-00 11 12 8 618 519	12-36866-03 11 34 0 038 719	71-12439-00 11 61 8 637 800		70-31414-10 	81-37002-00 11 11 8 604 931 55x68 AB RD PTFE
									61-10076-10 11 12 8 654 273 82 Ø 1 mm MLS				71-11394-00 11 62 7 617 523			81-10448-00 11 14 8 602 594 90x104 LD PTFE ACM
2,0	B46 B20 B	215 kW (292 PS)	X3 xDrive 30 e Plug-in-Hybrid (G01, F97)	12/19 <b>[NEW]</b>					61-10076-00 11 12 8 654 272 82 Ø 0,7 mm MLS	14-12261-02 11 12 7 613 127 (10X)	71-11411-00 11 12 8 618 519	12-36866-03 11 34 0 038 719	71-12439-00 11 61 8 637 800		70-31414-10 	81-37002-00 11 11 8 604 931 55x68 AB RD PTFE
									61-10076-10 11 12 8 654 273 82 Ø 1 mm MLS	14-13082-01 11 12 8 644 675 (10X)	71-17437-00 11 12 8 638 247	12-37256-01 11 34 0 035 853	4x 71-17375-00 11 61 9 486 362			81-10448-00 11 14 8 602 594 90x104 LD PTFE ACM
									61-10166-00 11 12 7 934 596 83 Ø 0,8 mm MLS				71-11394-00 11 62 7 617 523			
									61-10166-10 11 12 7 934 597 83 Ø 1,1 mm MLS				71-20960-00 11 65 8 631 900			

BMW

Ltr.    1

2,0 B47 C20 A 85-170 kW (116-231 PS) X2 sDrive 18 d (F39) 06/10  
 B47 C20 B X2 sDrive 20 d (F39)  
 B47 D20 A X2 xDrive 20 d (F39)  
 B47 D20 B X2 xDrive 25 d (F39)  
 X3 sDrive 18 d (F25)  
 X3 xDrive 20 d (F25)  
 X3 xDrive 20 d (G01, F97)  
 X3 xDrive 25 d (G01, F97)  
 X4 xDrive 20 d (F26)  
 X4 xDrive 20 d (G02, F98)  
 X4 xDrive 25 d (G02, F98)  
 118 d (F20)  
 118 d (F21)  
 118 d xDrive (F20)  
 118 d xDrive (F21)  
 120 d (F20)  
 120 d (F21)  
 120 d xDrive (F20)  
 120 d xDrive (F21)  
 218 d (F22, F87)  
 218 d (F23)  
 220 d (F22, F87)  
 220 d (F23)  
 220 d (F45)  
 220 d xDrive (F22, F87)  
 220 d xDrive (F45)  
 220 d xDrive(F22, F87)  
 318 d (F30)  
 318 d (F31)  
 318 d (F30)  
 318 d (F30, F35, F80)  
 318 d (F31)  
 318 d (F34)  
 318 d (G20, G80)  
 318 d xDrive (F30, F35, F80)  
 318 d xDrive (F31)  
 320 d (F30)  
 320 d (F30, F80)  
 320 d (F31)  
 320 d (F34)  
 320 d (G21)  
 320 d Mild-Hybrid (G21)  
 320 d xDrive (F30, F80)  
 320 d xDrive (F31)  
 320 d xDrive (F34)  
 320 d xDrive (G21)  
 320 d xDrive Mild-Hybrid (G21)  
 418 d (F32, F82)  
 418 d (F36)  
 420 d (F32, F82)  
 420 d (F33, F83)  
 420 d (F36)  
 420 d xDrive (F32, F82)  
 420 d xDrive (F36)  
 518 d (F10)  
 518 d (F11)  
 520 d (F10)  
 520 d (F10, F18)  
 520 d (F11)  
 520 d (G30)  
 520 d (G31)  
 520 d sDrive (F11)  
 520 d xDrive (F10)  
 520 d xDrive (F11)  
 520 d xDrive (G30)  
 520 d xDrive (G31)  
 525 d (G30, F90)  
 525 d (G31)

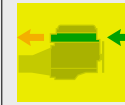

02-10188-01

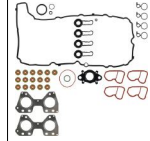

61-10188-00  
 11 12 8 513 699  
 85 Ø  
 1,3 mm  
 MLS



61-10188-10  
 11 12 8 513 700  
 85 Ø  
 1,4 mm  
 MLS



61-10188-20  
 11 12 8 513 701  
 85 Ø  
 1,5 mm  
 MLS



14-10398-01  
 11 12 7 807 294



15-10045-01  
 11 12 8 583 293

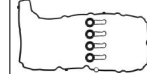

12-39398-01  
 11 34 7 807 347



70-39398-00 16x

71-11831-00  
 11 61 8 571 001



71-39421-10  
 11 62 8 509 783



70-31414-10



81-39382-00 K

11 11 7 802 665  
 55x68  
 RD FPM



81-39379-00 K

11 14 7 797 490  
 90x104  
 LD FPM



















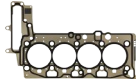

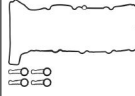
BMW

Ltr.																	
2,0	B47 C20 A B47 C20 B B47 D20 A B47 D20 B	100-170 kW (136-231 PS)	11/13														
				X1 sDrive 18 d (F48) X1 sDrive 20 d (F48) X1 xDrive 18 d (F48) X1 xDrive 20 d (F48) X1 xDrive 25 d (F48) X3 sDrive 18 d (G01) X3 sDrive 18 d (G01, F97) X3 xDrive 20 d (G01) X3 xDrive 20 d (G01, F97) X5 sDrive 25 d (F15, F85) X5 xDrive 25 d (F15, F85) 125 d (F20) 125 d (F21) 218 d (F45) 218 d (F46) 218 d xDrive (F45) 218 d xDrive (F46) 220 d (F45) 220 d (F46) 220 d xDrive (F45) 220 d xDrive (F46) 225 d (F22, F87) 225 d (F23) 325 d (F30, F80) 325 d (F31) 425 d (F32, F82) 425 d (F33, F83) 425 d (F36) 725 d, LD (G11, G12)	02-10188-01 				61-10188-00 11 12 8 513 699 85 Ø 1,3 mm MLS  61-10188-10 11 12 8 513 700 85 Ø 1,4 mm MLS  61-10188-20 11 12 8 513 701 85 Ø 1,5 mm MLS 	14-10398-01 11 12 7 807 294 	15-10045-01 11 12 8 583 293 	12-39398-01 11 34 7 807 347 	71-11831-00 11 61 8 571 001  71-39421-10 11 62 8 509 783 	4x 2x	70-31414-10 	81-39382-00 11 11 7 802 665 55x68 RD FPM  81-39379-00 11 14 7 797 490 90x104 LD FPM 	
2,0	B47 C20 B B47 D20 B	85-140 kW (116-190 PS)	07/19 <b>NEW!</b>			08-11344-01											
				118 d (F40) 120 d (F40) 120 d xDrive (F40) 218 d (F44) 220 d (F44) 220 d xDrive (F44) 316 d (G20, G80, G28) 316 d (G21, G81) 316 d Mild-Hybrid (G20, G80, G28) 316 d Mild-Hybrid (G21, G81) 318 d Mild-Hybrid (G20, G80, G28) 318 d Mild-Hybrid (G21, G81) 320 d Mild-Hybrid (G20, G80, G28) 320 d Mild-Hybrid (G21, G81) 320 d xDrive (F21, G81) 320 d xDrive Mild-Hybrid (G20, G80, G28) 320 d xDrive Mild-Hybrid (G21, G81) 420 d Mild-Hybrid (G22, G82) 420 d Mild-Hybrid (G23, G83) 420 d Mild-Hybrid (G26) 420 d xDrive Mild-Hybrid (G22, G82) 420 d xDrive Mild-Hybrid (G26)	02-10188-01 	08-11344-01			61-10483-00 11 12 8 594 566 85 Ø 1,3 mm MLS  61-10483-10 11 12 8 594 567 85 Ø 1,4 mm MLS  61-10483-20 11 12 8 594 568 85 Ø 1,5 mm MLS 	14-10398-01 11 12 7 807 294 	15-10930-01 11 12 8 473 265 	12-39398-01 11 34 7 807 347 	71-11831-00 11 61 8 571 001  71-39421-10 11 62 8 509 783 	4x 2x	70-31414-10 	81-39382-00 11 11 7 802 665 55x68 RD FPM  81-10659-00 11 14 8 599 771 90x104 AB LD FPM 	
2,0	B47 C20 B B47 D20 B	100-165 kW (136-224 PS)	03/16														
				X2 xDrive 18 d (F39) X3 xDrive 25 d (G01, F97) X4 xDrive 25 d (G02, F98) 325 d (F34) 425 d (F36)	02-10188-01 												









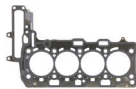
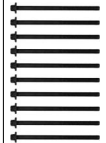
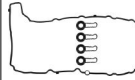

BMW															
2,0	B47 C20 B	110 kW (150 PS)	116 d (F40)	07/19 <b>[NEW]</b>		02-11344-01	08-11344-01		<p><b>61-10483-00</b> 11 12 8 594 566 85 Ø 1,3 mm MLS</p> <p><b>61-10483-10</b> 11 12 8 594 567 85 Ø 1,4 mm MLS</p> <p><b>61-10483-20</b> 11 12 8 594 568 85 Ø 1,5 mm MLS</p>	<p><b>14-10398-01</b> 11 12 7 807 294</p>	<p><b>15-10930-01</b> 11 12 8 473 265</p>	<p><b>12-39398-01</b> 11 34 7 807 347</p> <p><b>70-39398-00</b> 16x</p>	<p><b>71-11831-00</b>  4x 11 61 8 571 001</p> <p><b>71-39421-10</b>  2x 11 62 8 509 783</p>	<p><b>70-31414-10</b></p>	<p><b>81-39382-00</b> <b>K</b> 11 11 7 802 665 55x68 RD FPM</p> <p><b>81-10659-00</b> <b>K</b> 11 14 8 599 771 90x104 AB LD FPM</p>
2,0	B47 C20 B	110-140 kW (150-190 PS)	218 d (F45) 218 d (F46) 220 d (F45) 220 d (F46)	11/13		02-10188-01			<p><b>61-10483-00</b> 11 12 8 594 566 85 Ø 1,3 mm MLS</p> <p><b>61-10483-10</b> 11 12 8 594 567 85 Ø 1,4 mm MLS</p> <p><b>61-10483-20</b> 11 12 8 594 568 85 Ø 1,5 mm MLS</p>	<p><b>14-10398-01</b> 11 12 7 807 294</p>	<p><b>15-10930-01</b> 11 12 8 473 265</p>	<p><b>12-39398-01</b> 11 34 7 807 347</p> <p><b>70-39398-00</b> 16x</p>	<p><b>71-11831-00</b>  4x 11 61 8 571 001</p> <p><b>71-39421-10</b>  2x 11 62 8 509 783</p>	<p><b>70-31414-10</b></p>	<p><b>81-39382-00</b> <b>K</b> 11 11 7 802 665 55x68 RD FPM</p> <p><b>81-39379-00</b> <b>K</b> 11 14 7 797 490 90x104 LD FPM</p>
2,0	B47 C20 B B47 D20 B	110-140 kW (150-190 PS)	X1 sDrive 18 d (F48) X1 sDrive 20 d (F48) X1 xDrive 20 d (F48) X3 sDrive 18 d (G01) X3 sDrive 18 d (G01, F97) X3 xDrive 20 d (G01) X3 xDrive 20 d (G01, F97)	07/15 <b>[NEW]</b>		02-11344-01	08-11344-01		<p><b>61-10483-00</b> 11 12 8 594 566 85 Ø 1,3 mm MLS</p> <p><b>61-10483-10</b> 11 12 8 594 567 85 Ø 1,4 mm MLS</p> <p><b>61-10483-20</b> 11 12 8 594 568 85 Ø 1,5 mm MLS</p>	<p><b>14-10398-01</b> 11 12 7 807 294</p>	<p><b>15-10930-01</b> 11 12 8 473 265</p>	<p><b>12-39398-01</b> 11 34 7 807 347</p> <p><b>70-39398-00</b> 16x</p>	<p><b>71-11831-00</b>  4x 11 61 8 571 001</p> <p><b>71-39421-10</b>  2x 11 62 8 509 783</p>	<p><b>70-31414-10</b></p>	<p><b>81-39382-00</b> <b>K</b> 11 11 7 802 665 55x68 RD FPM</p> <p><b>81-39379-00</b> <b>K</b> 11 14 7 797 490 90x104 LD FPM</p>

BMW







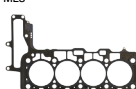
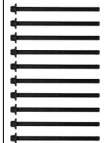

Ltr.  2,0 B47 D20 A 100 kW (136 PS) 218 d (F22, F87) 03/14-09/20 

				<p><b>61-38110-00</b> 11 12 8 509 146 84,7 Ø 1,45 mm MLS</p> <p><b>61-38110-10</b> 11 12 8 509 147 84,7 Ø 1,55 mm MLS</p> <p><b>61-38110-20</b> 11 12 8 509 148 84,7 Ø 1,65 mm MLS</p> 	<p><b>14-10398-01</b> 11 12 7 807 294</p> 	<p><b>15-41286-01</b> 11 12 8 511 814</p> 	<p><b>12-39398-01</b> 11 34 7 807 347</p>  <p><b>70-39398-00</b> 16x</p> 	<p><b>71-10389-00</b>  11 61 8 506 407</p>  <p><b>71-39421-10</b> 2x</p> 	<p><b>70-31414-10</b></p> 	<p><b>81-39382-00</b>  <b>K</b></p> <p>11 11 7 802 665 55x68 RD FPM</p>  <p><b>81-39379-00</b>  <b>K</b></p> <p>11 14 7 797 490 90x104 LD FPM</p> 
--	--	---	--	--	---	---	---	--	---	--

2,0 B47 D20 A 120 kW (163 PS) 420 d xDrive (F32, F82) 11/13

				<p><b>61-10188-00</b> 11 12 8 513 699 85 Ø 1,3 mm MLS</p> <p><b>61-10188-10</b> 11 12 8 513 700 85 Ø 1,4 mm MLS</p> <p><b>61-10188-20</b> 11 12 8 513 701 85 Ø 1,5 mm MLS</p> 	<p><b>14-10398-01</b> 11 12 7 807 294</p> 	<p><b>15-10045-01</b> 11 12 8 583 293</p> 	<p><b>12-39398-01</b> 11 34 7 807 347</p> 	<p><b>71-11831-00</b>  4x 11 61 8 571 001</p>  <p><b>71-39421-10</b> 2x</p> 	<p><b>70-31414-10</b></p> 	<p><b>81-39382-00</b>  <b>K</b></p> <p>11 11 7 802 665 55x68 RD FPM</p>  <p><b>81-39379-00</b>  <b>K</b></p> <p>11 14 7 797 490 90x104 LD FPM</p> 
--	--	--	--	---	---	---	---	---	---	--

























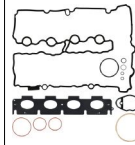
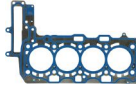

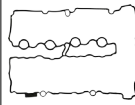
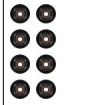









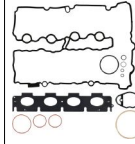
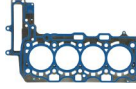

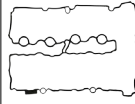











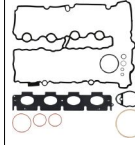
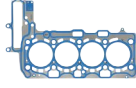

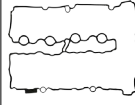
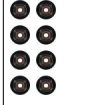









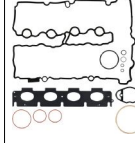
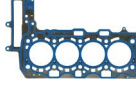

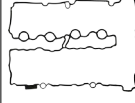
2,0 B47 D20 B 100-120 kW (136-163 PS) 318 d (G20, G80) 318 d (G21, G81) 320 d (G21, G81) 03/19-07/20

				<p><b>61-10483-00</b> 11 12 8 594 566 85 Ø 1,3 mm MLS</p> <p><b>61-10483-10</b> 11 12 8 594 567 85 Ø 1,4 mm MLS</p> <p><b>61-10483-20</b> 11 12 8 594 568 85 Ø 1,5 mm MLS</p> 	<p><b>14-10398-01</b> 11 12 7 807 294</p> 	<p><b>15-10930-01</b> 11 12 8 473 265</p> 	<p><b>12-39398-01</b> 11 34 7 807 347</p> 	<p><b>71-17090-00</b>  4x 11 61 7 822 216</p>  <p><b>71-39421-10</b> 2x</p> 		<p><b>81-39382-00</b>  <b>K</b></p> <p>11 11 7 802 665 55x68 RD FPM</p> 
--	--	--	--	---	---	---	---	---	--	--

BMW

Ltr.														
2,0	B47 D20 B	100-170 kW (136-231 PS)	X3 sDrive 18 d Mild-Hybrid (G01, F97) X3 xDrive 20 d Mild-Hybrid (G01, F97) X4 xDrive 20 d Mild-Hybrid (G02, F98) X5 xDrive 25 d (G05, F95) 320 d (G21, G81) 320 d Mild-Hybrid (G21, G81) 320 d xDrive (F21, G81) 320 d xDrive Mild-Hybrid (G21, G81) 518 d Mild-Hybrid (G30, F90) 518 d Mild-Hybrid (G31) 520 d (G31) 520 d Mild-Hybrid (G30, F90) 520 d Mild-Hybrid (G31) 520 d xDrive Mild-Hybrid (G30, F90) 520 d xDrive Mild-Hybrid (G31) 523 d xDrive Mild-Hybrid (G30, F90) 620 d Mild-Hybrid (G32) 620 d xDrive Mild-Hybrid (G32)	03/17 <b>[NEW]</b>										
2,0	B47 D20 B	110 kW (150 PS)	518 d Mild-Hybrid (G30, F90)	07/20 <b>[NEW]</b>										
2,0	B47 D20 B	140 kW (190 PS)	620 d (G32)	07/18-06/20										
					02-11342-01	08-11342-01		<p><b>61-10483-00</b> 11 12 8 594 566 85 Ø 1,3 mm MLS</p> <p><b>61-10483-10</b> 11 12 8 594 567 85 Ø 1,4 mm MLS</p> <p><b>61-10483-20</b> 11 12 8 594 568 85 Ø 1,5 mm MLS</p>	<p><b>14-10398-01</b> 11 12 7 807 294</p>	<p><b>15-10930-01</b> 11 12 8 473 265</p>	<p><b>12-39398-01</b> 11 34 7 807 347</p> <p><b>70-39398-00</b> 16x</p>	<p><b>71-17090-00</b>  4x 11 61 7 822 216</p> <p><b>71-39421-10</b>  2x 11 62 8 509 783</p>	<p><b>70-31414-10</b></p>	<p><b>81-39382-00</b> <b>K</b>↔ 11 11 7 802 665 55x68 RD FPM</p> <p><b>81-10659-00</b> <b>K</b>↔ 11 14 8 599 771 90x104 AB LD FPM</p>
					02-11342-01	08-11342-01		<p><b>61-10483-00</b> 11 12 8 594 566 85 Ø 1,3 mm MLS</p> <p><b>61-10483-10</b> 11 12 8 594 567 85 Ø 1,4 mm MLS</p> <p><b>61-10483-20</b> 11 12 8 594 568 85 Ø 1,5 mm MLS</p>	<p><b>14-10398-01</b> 11 12 7 807 294</p>	<p><b>15-10930-01</b> 11 12 8 473 265</p>	<p><b>12-39398-01</b> 11 34 7 807 347</p> <p><b>70-39398-00</b> 16x</p>	<p><b>71-11831-00</b>  4x 11 61 8 571 001</p> <p><b>71-39421-10</b>  2x 11 62 8 509 783</p>	<p><b>70-31414-10</b></p>	<p><b>81-39382-00</b> <b>K</b>↔ 11 11 7 802 665 55x68 RD FPM</p> <p><b>81-10659-00</b> <b>K</b>↔ 11 14 8 599 771 90x104 AB LD FPM</p>
								<p><b>61-10483-00</b> 11 12 8 594 566 85 Ø 1,3 mm MLS</p> <p><b>61-10483-10</b> 11 12 8 594 567 85 Ø 1,4 mm MLS</p> <p><b>61-10483-20</b> 11 12 8 594 568 85 Ø 1,5 mm MLS</p>	<p><b>14-10398-01</b> 11 12 7 807 294</p>	<p><b>15-10930-01</b> 11 12 8 473 265</p>	<p><b>12-39398-01</b> 11 34 7 807 347</p> <p><b>70-39398-00</b> 16x</p>	<p><b>71-17090-00</b>  4x 11 61 7 822 216</p> <p><b>71-39421-10</b>  2x 11 62 8 509 783</p>	<p><b>70-31414-10</b></p>	<p><b>81-39382-00</b> <b>K</b>↔ 11 11 7 802 665 55x68 RD FPM</p> <p><b>81-39379-00</b> <b>K</b>↔ 11 14 7 797 490 90x104 LD FPM</p>

BMW

Ltr.														
2,0	B48 A20 A B48 A20 B B48 A20 F	120-141 kW (163-192 PS)	X1 sDrive (F48) X1 sDrive 20 i (F48) X1 xDrive (F48) 220i (F45) 220i (F46)	03/14				<p><b>61-10076-00</b> 11 12 8 654 272 82 Ø 0,7 mm MLS</p> <p><b>61-10076-10</b> 11 12 8 654 273 82 Ø 1 mm MLS</p> 	<p><b>14-12261-02</b> 11 12 7 613 127 (10X)</p> 	<p><b>71-11411-00</b> 11 12 8 618 519</p> 	<p><b>12-36866-03</b> 11 34 0 038 719</p> 	<p><b>71-11403-00</b>  4x 11 61 7 633 493</p>  <p><b>71-11394-00</b>  11 62 7 617 523</p> 	<p><b>70-31414-10</b></p> 	<p><b>81-37002-00</b>  11 11 8 604 931 55x68 AB RD PTFE</p>  <p><b>81-10448-00</b>  11 14 8 602 594 90x104 LD PTFE ACM</p> 
2,0	B48 A20 A	141 kW (192 PS)	X2 sDrive 20 i (F39) 220i Flex (F45)	01/17				<p><b>61-10076-00</b> 11 12 8 654 272 82 Ø 0,7 mm MLS</p> <p><b>61-10076-10</b> 11 12 8 654 273 82 Ø 1 mm MLS</p> 	<p><b>14-12261-02</b> 11 12 7 613 127 (10X)</p> 	<p><b>71-11411-00</b> 11 12 8 618 519</p> 	<p><b>12-36866-03</b> 11 34 0 038 719</p>  <p><b>70-36866-00</b> 11 34 7 539 918</p> 	<p><b>71-11403-00</b>  4x 11 61 7 633 493</p>  <p><b>71-11394-00</b>  11 62 7 617 523</p> 	<p><b>70-31414-10</b></p> 	<p><b>81-37002-00</b>  11 11 8 604 931 55x68 AB RD PTFE</p>  <p><b>81-10448-00</b>  11 14 8 602 594 90x104 LD PTFE ACM</p> 
2,0	B48 A20 B	141 kW (192 PS)	220i Flex (F45)	01/17-10/21				<p><b>61-38195-00</b> 11 12 8 627 107 83 Ø 0,7 mm MLS</p> <p><b>61-38195-10</b> 11 12 8 627 108 83 Ø 1 mm MLS</p> 	<p><b>14-12261-02</b> 11 12 7 613 127 (10X)</p> 	<p><b>71-11411-00</b> 11 12 8 618 519</p> 	<p><b>12-36866-03</b> 11 34 0 038 719</p> 	<p><b>71-11403-00</b>  4x 11 61 7 633 493</p>  <p><b>71-11394-00</b>  11 62 7 617 523</p> 	<p><b>70-31414-10</b></p> 	<p><b>81-37002-00</b>  11 11 8 604 931 55x68 AB RD PTFE</p>  <p><b>81-10448-00</b>  11 14 8 602 594 90x104 LD PTFE ACM</p> 
2,0	B48 A20 B	170 kW (231 PS)	X1 xDrive 25 i (F48)	07/15				<p><b>61-10076-00</b> 11 12 8 654 272 82 Ø 0,7 mm MLS</p> <p><b>61-10076-10</b> 11 12 8 654 273 82 Ø 1 mm MLS</p> 	<p><b>14-12261-02</b> 11 12 7 613 127 (10X)</p> 	<p><b>71-11411-00</b> 11 12 8 618 519</p> 		<p><b>70-31414-10</b>  11 61 7 633 493</p>  <p><b>71-11403-00</b>  4x 11 61 7 633 493</p>  <p><b>71-11394-00</b>  11 62 7 617 523</p> 		<p><b>81-37002-00</b>  11 11 8 604 931 55x68 AB RD PTFE</p>  <p><b>81-10448-00</b>  11 14 8 602 594 90x104 LD PTFE ACM</p> 

BMW																
Ltr.																
2,0	B48 A20 B	170 kW (231 PS)	225 i (F45)	11/13-12/19		<b>02-11411-02</b> 				<b>61-38195-00</b> 11 12 8 627 107 83 Ø 0,7 mm MLS [5] ⇒ 06/15  <b>61-38195-10</b> 11 12 8 627 108 83 Ø 1 mm MLS [5] ⇒ 06/15 	<b>14-12261-02</b> 11 12 7 613 127 (10x) [5] ⇒ 01/15 	<b>71-11411-00</b> 11 12 8 618 519 	<b>12-36866-03</b> 11 34 0 038 719 	<b>71-11403-00</b> [5] 4x 11 61 7 633 493   <b>71-11394-00</b> [5] 11 62 7 617 523 	<b>70-31414-10</b> 	<b>81-37002-00</b> [5] [5] 11 11 8 604 931 55x68 AB RD PTFE   <b>81-10448-00</b> [5] [5] 11 14 8 602 594 90x104 LD PTFE ACM 
2,0	B48 A20 B	170 kW (231 PS)	225 i xDrive (F45)	03/14-10/21		<b>02-11411-02</b> 				<b>61-38195-00</b> 11 12 8 627 107 83 Ø 0,7 mm MLS [5] ⇒ 06/15  <b>61-38195-10</b> 11 12 8 627 108 83 Ø 1 mm MLS [5] ⇒ 06/15 	<b>14-12261-02</b> 11 12 7 613 127 (10x) [5] ⇒ 01/15 	<b>71-11411-00</b> 11 12 8 618 519 	<b>12-36866-03</b> 11 34 0 038 719 	<b>71-11403-00</b> [5] 4x 11 61 7 633 493   <b>71-11394-00</b> [5] 11 62 7 617 523 	<b>70-31414-10</b> 	<b>81-37002-00</b> [5] [5] 11 11 8 604 931 55x68 AB RD PTFE   <b>81-10448-00</b> [5] [5] 11 14 8 602 594 90x104 LD PTFE ACM 
2,0	B48 A20 E	225 kW (306 PS)	M 135 i xDrive (F40)	07/19 <b>[NEW]</b>		<b>02-11346-01</b> 	<b>08-11346-01</b>			<b>61-10226-00</b> 11 12 8 481 576 83 Ø 0,8 mm MLS [1] [5]  <b>61-10226-10</b> 11 12 8 481 577 83 Ø 1,1 mm MLS [2] [5] 	<b>14-12261-02</b> 11 12 7 613 127 (10x) 	<b>71-17437-00</b> 11 12 8 638 247 	<b>12-36866-03</b> 11 34 0 038 719   <b>12-37256-01</b> 11 34 0 035 853 	<b>71-11403-00</b> [5] 4x 11 61 7 633 493   <b>71-11404-00</b> [5] 1x 11 61 7 633 558   <b>71-17430-00</b> [5] 11 62 8 642 774 	<b>70-31414-10</b> 	<b>81-37002-00</b> [5] [5] 11 11 8 604 931 55x68 AB RD PTFE   <b>81-10448-00</b> [5] [5] 11 14 8 602 594 90x104 LD PTFE ACM 



BMW













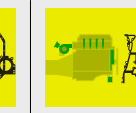

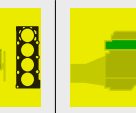
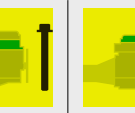
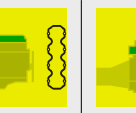
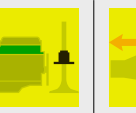
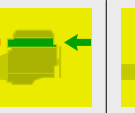

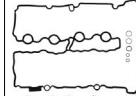

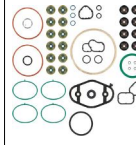



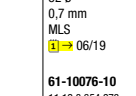



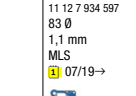

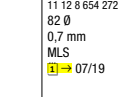

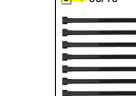

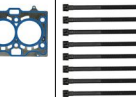

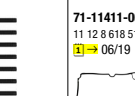
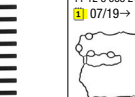



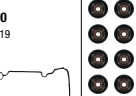
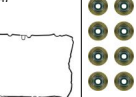





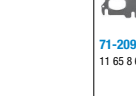

Ltr.														
2,0	B48 B20 A B48 B20 B	120-240 kW (163-326 PS)	X3 xDrive 30 i (G01, F97) X4 xDrive 30 i (G02, F98) 125 i (F20) 125 i (F21) 230 i (F22, F87) 230 i (F23) 320 i (G20, G80) 330 e xDrive (G20, G80, G28) 330 i (F30, F80) 330 i (F31) 330 i (G20, G80) 330 i (G21) 330 i xDrive (F30, F80) 330 i xDrive (F31) 330 i xDrive (F34) 430 i (F32, F82) 430 i (F33, F83) 430 i (F36) 430 i xDrive (F32, F82) 430 i xDrive (F33, F83) 430 i xDrive (F36) 520 i (G30, F90) 520 i (G31) 530 i (G30) 530 i (G31) 530 i xDrive (G30, F90) 530 i xDrive (G31) 630 i (G32) 730 i (G11, G12) 730 i, Li (G11, G12) 740 e, Le (G11, G12) 740 e, Le xDrive (G11, G12)	07/15				 11 12 8 654 272 82 Ø 0,7 mm MLS   11 12 8 654 273 82 Ø 1 mm MLS	 11 12 8 644 675 (10X)	 11 12 8 618 519	 11 34 0 038 719   11 34 0 035 853	 11 61 8 637 800   11 62 7 617 523	4x 	 11 11 8 604 931 55x68 AB RD PTFE   11 14 8 602 594 90x104 LD PTFE ACM
2,0	B48 B20 A	135 kW (184 PS)	520 i (G31)	07/17-06/20			 11 12 8 654 272 82 Ø 0,7 mm MLS   11 12 8 654 273 82 Ø 1 mm MLS	 11 12 7 613 127 (10X)	 11 12 8 618 519	 11 34 0 038 719   11 34 0 035 853   11 34 7 539 918 8x   11 34 7 573 689 6x	 11 61 8 637 800   11 62 7 617 523	4x 	 11 11 8 604 931 55x68 AB RD PTFE   11 14 8 602 594 90x104 LD PTFE ACM	

BMW



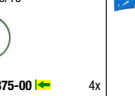







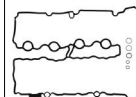

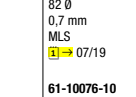

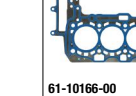

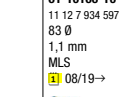

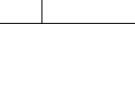

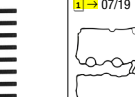



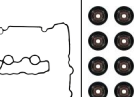
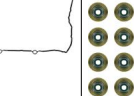

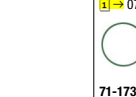



Ltr.	Motor	Power	Models	Date	Image 1	Image 2	Image 3	Image 4	Image 5	Image 6	Image 7	Image 8	Image 9	Image 10	Image 11
2,0	B48 B20 A	135-185 kW (184-252 PS)	220i (F22, F87) 220i (F23) 320i (F30, F80) 320i (F31) 320i (F34) 320i xDrive (F30, F80) 320i xDrive (F31) 320i xDrive (F34) 330e (F30, F80) 420i (F32, F82) 420i (F33, F83) 420i (F36) 420i xDrive (F32, F82) 420i xDrive (F36)	07/15											
					02-11411-01 					14-12261-02 11 12 7 613 127 (10x) 					
2,0	B48 B20 A	215 kW (292 PS)	330e xDrive (G21, G81)	07/20 <b>[NEW]</b>		02-11361-01 	08-11361-01 			61-10166-00 11 12 7 934 596 83 Ø 0,8 mm MLS 1  61-10166-10 11 12 7 934 597 83 Ø 1,1 mm MLS 2 	14-12261-02 11 12 7 613 127 (10x) 	71-17437-00 11 12 8 638 247 	12-36866-03 11 34 0 038 719 	71-17375-00 11 61 9 486 362 4x  71-20960-00 11 65 8 631 900 1x	81-37002-00 11 11 8 604 931 55x68 AB RD PTFE  81-10448-00 11 14 8 602 594 90x104 LD PTFE ACM 
2,0	B48 B20 B	180-185 kW (245-252 PS)	430i xDrive (G22, G82) 430i xDrive (G23, G83) 530i Mild-Hybrid (G30, F90)	07/20 <b>[NEW]</b>		02-11361-01 	08-11361-01 			61-10166-00 11 12 7 934 596 83 Ø 0,8 mm MLS 1  61-10166-10 11 12 7 934 597 83 Ø 1,1 mm MLS 2 	14-12261-02 11 12 7 613 127 (10x) 	15-11221-01 11 12 9 797 205  71-17437-00 11 12 8 638 247 	12-36866-03 11 34 0 038 719 	71-17375-00 11 61 9 486 362  71-17430-00 11 62 8 642 774  71-20960-00 11 65 8 631 900	70-31414-10  81-37002-00 11 11 8 604 931 55x68 AB RD PTFE  81-10448-00 11 14 8 602 594 90x104 LD PTFE ACM 

BMW



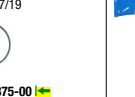









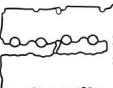





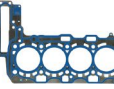
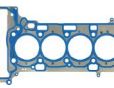



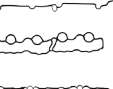



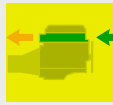

















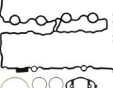
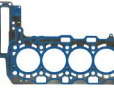

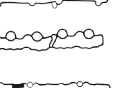
Ltr.  B48 B20 B 183 kW (249 PS) X3 xDrive 30 i (G01, F97) 09/16  
530 i xDrive (G30, F90) 

											
	<p><b>02-11411-01</b>  11 12 8 654 272 82 Ø 0,7 mm MLS  ⇒ 06/19</p> <p><b>02-11361-01</b>  11 12 7 934 596 83 Ø 0,8 mm MLS  ⇒ 07/19→</p>	<p><b>08-11361-01</b>  11 12 8 654 272 82 Ø 0,7 mm MLS  ⇒ 06/19</p>		<p><b>61-10076-00</b>  11 12 8 654 272 82 Ø 0,7 mm MLS  ⇒ 06/19</p> <p><b>61-10076-10</b>  11 12 8 654 273 82 Ø 1 mm MLS  ⇒ 06/19</p> <p><b>61-10166-00</b>  11 12 7 934 596 83 Ø 0,8 mm MLS  ⇒ 07/19→</p> <p><b>61-10166-10</b>  11 12 7 934 597 83 Ø 1,1 mm MLS  ⇒ 07/19→</p>	<p><b>14-12261-02</b>  11 12 7 613 127 (10X)  ⇒ 06/19</p> <p><b>14-13082-01</b>  11 12 8 644 675 (10X)  ⇒ 07/19→</p>	<p><b>15-11221-01</b>  11 12 9 797 205</p> <p><b>71-11411-00</b>  11 12 8 618 519  ⇒ 06/19</p> <p><b>71-17437-00</b>  11 12 8 638 247  ⇒ 07/19→</p>	<p><b>12-36866-03</b>  11 34 0 038 719</p> <p><b>12-37256-01</b>  11 34 0 035 853</p>	<p><b>71-12439-00</b>  4x  11 61 8 637 800  ⇒ 06/19</p> <p><b>71-17375-00</b>  4x  11 61 9 486 362  ⇒ 07/19→</p> <p><b>71-11394-00</b>   11 62 7 617 523  ⇒ 06/19</p> <p><b>71-17430-00</b>   11 62 8 642 774  ⇒ 07/19→</p> <p><b>71-20960-00</b>   11 65 8 631 900</p>	<p><b>70-31414-10</b> </p>	<p><b>81-37002-00</b>   11 11 8 604 931 55x68 AB RD PTFE</p> <p><b>81-10448-00</b>   11 14 8 602 594 90x104 LD PTFE ACM</p>	



































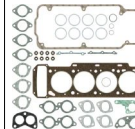

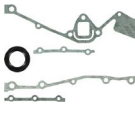



















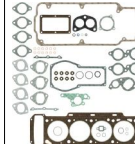
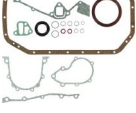







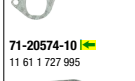



2,0 B48 B20 B 183-185 kW (249-252 PS) X3 xDrive 30 i (G01) 08/17  
X4 xDrive 30 i (G02, F90)

	<p><b>02-11411-01</b>  11 12 8 654 272 82 Ø 0,7 mm MLS  ⇒ 07/19</p>		<p><b>61-10076-00</b>  11 12 8 654 272 82 Ø 0,7 mm MLS  ⇒ 07/19</p> <p><b>61-10076-10</b>  11 12 8 654 273 82 Ø 1 mm MLS  ⇒ 07/19</p> <p><b>61-10166-00</b>  11 12 7 934 596 83 Ø 0,8 mm MLS  ⇒ 08/19→</p> <p><b>61-10166-10</b>  11 12 7 934 597 83 Ø 1,1 mm MLS  ⇒ 08/19→</p>	<p><b>14-13082-01</b>  11 12 8 644 675 (10X)</p>	<p><b>71-11411-00</b>  11 12 8 618 519  ⇒ 07/19</p> <p><b>71-17437-00</b>  11 12 8 638 247  ⇒ 08/19→</p>	<p><b>12-36866-03</b>  11 34 0 038 719</p> <p><b>12-37256-01</b>  11 34 0 035 853</p>	<p><b>71-12439-00</b>  4x  11 61 8 637 800  ⇒ 07/19</p> <p><b>71-17375-00</b>   11 61 9 486 362  ⇒ 08/19→</p> <p><b>71-11394-00</b>   11 62 7 617 523  ⇒ 07/19</p> <p><b>71-17430-00</b>   11 62 8 642 774  ⇒ 08/19→</p>	<p><b>70-31414-10</b> </p>	<p><b>81-37002-00</b>   11 11 8 604 931 55x68 AB RD PTFE</p> <p><b>81-10448-00</b>   11 14 8 602 594 90x104 LD PTFE ACM</p>
--	---	--	---	---	--	---	--	---	---

BMW



<p>Ltr.  B48 B20 B</p> <p>183-185 kW (249-252 PS)</p> <p>530i (G31) 530i xDrive (G31) 630i xDrive (G32)</p> <p>03/17</p> <p><b>1</b></p> <p><b>[NEW]</b></p>		 <p><b>02-11411-01</b> 11 12 8 654 272 0,7 mm MLS 1 ⇒ 06/18</p>  <p><b>02-11361-01</b> 11 12 7 934 596 0,8 mm MLS 1 ⇒ 07/18 →</p> 	 <p><b>08-11361-01</b> 11 12 7 934 597 1,1 mm MLS 1 ⇒ 07/18 →</p> 		 <p><b>61-10076-00</b> 11 12 8 654 272 82 Ø 0,7 mm MLS 1 ⇒ 06/18</p> <p><b>61-10076-10</b> 11 12 8 654 273 82 Ø 1 mm MLS 1 ⇒ 06/18</p>  <p><b>61-10166-00</b> 11 12 7 934 596 83 Ø 0,8 mm MLS 1 ⇒ 07/18 →</p> <p><b>61-10166-10</b> 11 12 7 934 597 83 Ø 1,1 mm MLS 1 ⇒ 07/18 →</p> 	 <p><b>14-12261-02</b> 11 12 7 613 127 (10X) 1 ⇒ 06/18</p>  <p><b>14-13082-01</b> 11 12 8 644 675 (10X) 1 ⇒ 07/18 →</p> 	 <p><b>15-11221-01</b> 11 12 9 797 205</p> <p><b>71-11411-00</b> 11 12 8 618 519 1 ⇒ 06/18</p>  <p><b>71-17437-00</b> 11 12 8 638 247 1 ⇒ 07/18 →</p> 	 <p><b>12-36866-03</b> 11 34 0 038 719</p>  <p><b>12-37256-01</b> 11 34 0 035 853</p> 	 <p><b>71-12439-00</b>  4x 11 61 8 637 800 1 ⇒ 06/18</p>  <p><b>71-17375-00</b>  4x 11 61 9 486 362 1 ⇒ 07/18 →</p>  <p><b>71-11394-00</b>  11 62 7 617 523 1 ⇒ 06/18</p>  <p><b>71-17430-00</b>  11 62 8 642 774 1 ⇒ 07/18 →</p>  <p><b>71-20960-00</b>  11 65 8 631 900</p>	 <p><b>70-31414-10</b></p> 	 <p><b>81-37002-00</b>  11 11 8 604 931 55x68 AB RD PTFE</p>  <p><b>81-10448-00</b>  11 14 8 602 594 90x104 LD PTFE ACM</p> 
<p>2,0 B48 B20 B</p> <p>185 kW (252 PS)</p> <p>330i (F34)</p> <p>07/16</p>		<p><b>02-11411-01</b> 11 12 8 654 272 0,7 mm MLS</p> 			<p><b>61-10076-00</b> 11 12 8 654 272 82 Ø 0,7 mm MLS</p> <p><b>61-10076-10</b> 11 12 8 654 273 82 Ø 1 mm MLS</p> 	<p><b>14-13082-01</b> 11 12 8 644 675 (10X)</p> 	<p><b>71-11411-00</b> 11 12 8 618 519</p> 	<p><b>12-36866-03</b> 11 34 0 038 719</p>  <p><b>12-37256-01</b> 11 34 0 035 853</p> 	<p><b>71-12439-00</b>  4x 11 61 8 637 800</p>  <p><b>71-11394-00</b>  11 62 7 617 523</p> 	<p><b>81-37002-00</b>  11 11 8 604 931 55x68 AB RD PTFE</p>  <p><b>81-10448-00</b>  11 14 8 602 594 90x104 LD PTFE ACM</p> 	

BMW













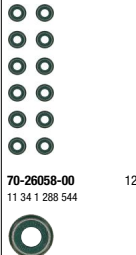





Ltr.														
2,0	M10 B20 M10 B20 A	74-96 kW (100-131 PS)	2000 2000 C/CA (E9) 2000 CS (E9) 2000 Ti 2000 Ti 2002 (E10) 2002 (E6) 2002 Ti (E10) 2002 Ti (E6) 320i (E21) 320i (E21) 520i (E12) 520i (E12)	10/65-08/82										
					<b>02-24190-22</b> 11 12 9 065 721 	<b>08-19737-03</b> 11 11 1 734 114 	<b>15-19747-01</b>  11 14 1 727 986 	<b>61-24190-60</b> 11 12 1 734 279 90 Ø 1,5 mm  <b>61-24190-70</b> 11 12 1 734 280 90 Ø 1,8 mm 	<b>14-32000-01</b> 11 12 0 621 144 (10x) 	<b>71-19738-50</b> 11 12 1 734 276 	<b>12-21025-01</b> 11 34 1 256 556 (8x)  <b>70-21025-00</b> 11 34 1 256 556 	<b>71-20560-10</b>  3x 11 61 1 727 994  <b>71-20574-10</b>  11 61 1 727 995  <b>71-26849-20</b>  4x 11 62 1 723 839  <b>71-21007-30</b>   18 11 1 728 363 	<b>71-19737-20</b> 11 13 1 727 974 	<b>81-19866-10</b>  11 14 1 709 632 35x55 A SL RD ACM  <b>81-20745-40</b>  11 14 2 245 364 90x110 A SL LD FPM 
2,0	M10 B20 (22T A)	125 kW (170 PS)	01/74		<b>02-24190-20</b> 11 12 9 065 724  01/75→ 	<b>08-19737-03</b> 11 11 1 734 114 	<b>61-24190-60</b> 11 12 1 734 279 90 Ø 1,5 mm  <b>61-24190-70</b> 11 12 1 734 280 90 Ø 1,8 mm 	<b>14-32000-01</b> 11 12 0 621 144 (10x) 	<b>71-19738-50</b> 11 12 1 734 276 	<b>12-21025-01</b> 11 34 1 256 556 (8x)  01/75→  <b>70-21025-00</b> 11 34 1 256 556  01/75→ 	<b>71-20560-10</b>  3x 11 61 1 727 994  <b>71-20574-10</b>  11 61 1 727 995  <b>71-23304-10</b>  2x 11 91 9 065 677  <b>71-26849-20</b>  4x 11 62 1 723 839  <b>71-21007-30</b>   18 11 1 728 363 	<b>71-19737-20</b> 11 13 1 727 974 	<b>81-20745-40</b>  11 14 2 245 364 90x110 A SL LD FPM  <b>81-19866-10</b>  11 14 1 709 632 35x55 A SL RD ACM 	

BMW																
2,0	M10 B20 (22TIU) M10 B20 (320EK) M10 B20 (320US)	74-125 kW (101-170 PS)														
Ltr.				<b>1</b>												
2,0	M10 B20 (23EA)	96 kW (130 PS)	2002 Tii (E10)	04/71-06/75	<p><b>02-24190-22</b> 11 12 9 065 721</p>	<p><b>08-19737-03</b> 11 11 1 734 114</p>	<p><b>15-19747-01</b> </p> <p>11 14 1 727 986</p>	<p><b>61-24190-60</b> 11 12 1 734 279 90 Ø 1,5 mm</p> <p><b>61-24190-70</b> 11 12 1 734 280 90 Ø 1,8 mm</p>		<p><b>71-19738-50</b> 11 12 1 734 276</p>	<p><b>12-21025-01</b> 11 34 1 256 556 (8x)</p>	<p><b>71-20560-10</b> </p> <p>11 61 1 727 994</p> <p><b>71-20574-10</b> </p> <p>11 61 1 727 995</p> <p><b>71-26849-20</b> </p> <p>11 62 1 723 839</p> <p><b>71-21007-30</b> </p> <p>18 11 1 728 363</p>	3x	<p><b>71-19737-20</b> 11 13 1 727 974</p>	<p><b>81-19866-10 K</b> </p> <p>11 14 1 709 632 35x55 A SL RD ACM</p> <p><b>81-20745-40 K</b> </p> <p>11 14 2 245 364 90x110 A SL LD FPM</p>	
2,0	M10 B20 (23EA)	96 kW (130 PS)	2002 Tii (E10)	04/71-06/75	<p><b>02-24190-22</b> 11 12 9 065 721</p>	<p><b>08-19737-03</b> 11 11 1 734 114</p>	<p><b>61-24190-60</b> 11 12 1 734 279 90 Ø 1,5 mm</p> <p><b>61-24190-70</b> 11 12 1 734 280 90 Ø 1,8 mm</p>	<p><b>14-32000-01</b> 11 12 0 621 144 (10x)</p>	<p><b>71-19738-50</b> 11 12 1 734 276</p>	<p><b>12-21025-01</b> 11 34 1 256 556 (8x)</p>	<p><b>71-20560-10</b> </p> <p>11 61 1 727 994</p> <p><b>71-20574-10</b> </p> <p>11 61 1 727 995</p> <p><b>71-26849-20</b> </p> <p>11 62 1 723 839</p>	8x	<p><b>71-20560-10</b> </p> <p>11 61 1 727 994</p> <p><b>71-20574-10</b> </p> <p>11 61 1 727 995</p> <p><b>71-26849-20</b> </p> <p>11 62 1 723 839</p>	4x	<p><b>71-19737-20</b> 11 13 1 727 974</p>	<p><b>81-19866-10 K</b> </p> <p>11 14 1 709 632 35x55 A SL RD ACM</p> <p><b>81-20745-40 K</b> </p> <p>11 14 2 245 364 90x110 A SL LD FPM</p>
2,0	M20 B20 M20 B20 (206EA) M20 B20 (206EB) M20 B20 (206EC) M20 B20 (206EE) M20 B20 (206EY) M20 B20 (206EZ) M20 B20 (206KA) M20 B20 (206VA)	90-110 kW (122-150 PS)	320 i (E30) 320/6 (E21) 520 i (E12) 520 i (E28) 520 i (E34) 520/6 (E12)	09/76	<p><b>02-24465-05</b> 11 12 9 059 248</p>	<p><b>08-24600-03</b> 11 11 1 730 875</p>	<p><b>61-24465-50</b> 11 12 1 722 726 81 Ø 2,05 mm</p> <p><b>61-24465-60</b> 11 12 1 722 725 81 Ø 1,75 mm</p>	<p><b>14-32001-01</b> 11 12 1 726 478</p>	<p><b>71-24469-10</b> 11 12 1 730 229</p>	<p><b>12-26058-01</b> 11 34 9 059 172</p>	<p><b>71-24593-10</b> </p> <p>11 61 1 730 743</p> <p><b>71-24594-10</b> </p> <p>11 61 1 730 787</p> <p><b>71-28708-10</b> </p> <p>11 62 1 723 838</p> <p><b>71-27467-00</b> </p> <p>11 76 1 711 717</p>	12x	<p><b>71-24593-10</b> </p> <p>11 61 1 730 743</p> <p><b>71-24594-10</b> </p> <p>11 61 1 730 787</p> <p><b>71-28708-10</b> </p> <p>11 62 1 723 838</p> <p><b>71-27467-00</b> </p> <p>11 76 1 711 717</p>	4x	<p><b>71-24600-20</b> 11 13 1 730 234</p>	<p><b>81-17404-50 K</b> </p> <p>11 14 1 265 431 48x65 AB SL RD FPM</p> <p><b>81-20745-40 K</b> </p> <p>11 14 2 245 364 90x110 A SL LD FPM</p> <p><b>81-24641-10 N</b></p> <p>11 12 1 285 609 38x50 A SL FPM</p>

BMW









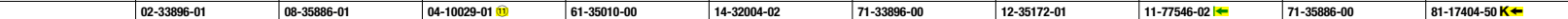

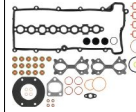





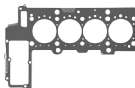
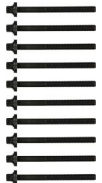
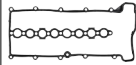
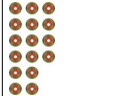



Ltr.     
 2,0 M20 B20 (206KA) 93 kW (126 PS) 320 i (E30) 10/86-04/91





<p><b>61-24465-50</b> 11 12 1 722 726 81 Ø 2,05 mm</p> <p><b>61-24465-60</b> 11 12 1 722 725 81 Ø 1,75 mm</p> 	<p><b>14-32001-01</b> 11 12 1 726 478</p> 	<p><b>71-24469-10</b> 11 12 1 730 229</p> 	<p><b>12-26058-01</b> 11 34 9 059 172</p>  <p><b>70-26058-00</b> 11 34 1 288 544</p> 	<p><b>71-27037-10</b>  4x 11 61 1 726 010</p>  <p><b>71-27038-10</b>  11 61 1 726 012</p>  <p><b>71-27122-10</b> 2x 11 62 1 728 489</p>  <p><b>71-27467-00</b>   2x 11 76 1 711 717</p> 	<p><b>71-24600-20</b> 11 13 1 730 234</p> 	<p><b>81-17404-50</b>  11 14 1 265 431 48x65 AB SL RD FPM</p>  <p><b>81-20745-40</b>  11 14 2 245 364 90x110 A SL LD FPM</p>  <p><b>81-24641-10</b> <b>N</b> 11 12 1 285 609 38x50 A SL FPM</p> 
---	---	---	---	--	---	---

2,0 M47 D20 (204D1) 85-100 kW (115-136 PS) 318 d (E46) 02/98-09/03  
 320 d (E46)  
 520 d (E39)



















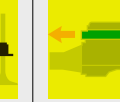

<p><b>02-33896-01</b> 11 12 2 247 501</p> 	<p><b>08-35886-01</b> 11 11 2 247 511</p> 	<p><b>04-10029-01</b> </p> 	<p><b>61-35010-00</b> 11 12 2 247 496 84 Ø 1  MLS</p> <p><b>61-35010-10</b> 11 12 2 247 499 84 Ø 2  MLS</p> <p><b>61-35010-20</b> 11 12 2 247 500 84 Ø 3  MLS</p> 	<p><b>14-32004-02</b> 11 12 9 067 792</p> 	<p><b>71-33896-00</b> 11 12 2 246 996</p> 	<p><b>12-35172-01</b> 11 34 9 070 962</p>  <p><b>70-35172-00</b> 16x 11 34 2 247 171</p> 	<p><b>11-77546-02</b> </p>  <p><b>71-33109-10</b>  4x 11 61 2 246 944</p>  <p><b>71-77546-00</b>   4x 11 61 2 246 945</p>  <p><b>71-33027-00</b> 4x 11 62 7 796 480</p> 	<p><b>71-35886-00</b> 11 13 8 070 005</p> 	<p><b>81-17404-50</b>  11 14 1 265 431 48x65 AB SL RD FPM</p>  <p><b>81-20745-40</b>  11 14 2 245 364 90x110 A SL LD FPM</p> 
---	--	---	---	---	---	---	---	---	---

BMW











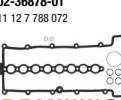

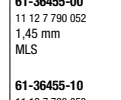
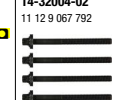
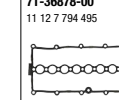
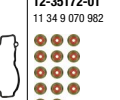
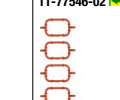
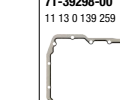
Ltr.   

2,0 M47 D20 (204D4) 85-120 kW (115-163 PS) X3 2.0 d (E83)  
 120 d (E87)  
 318 d (E46)  
 318 d (E90)  
 318 d (E91)  
 318 td (E46)  
 320 Cd (E46)  
 320 d (E46)  
 320 d (E90)  
 320 d (E91)  
 320 td (E46)  
 520 d (E60)  
 520 d (E61)

09/01-06/12 



										
	<b>02-36878-01</b> 11 12 7 788 072	<b>08-39298-01</b> 11 11 0 394 505	<b>04-10029-01</b> 	<b>61-36455-00</b> 11 12 7 790 052 1,45 mm MLS  <b>61-36455-10</b> 11 12 7 790 053 1,55 mm MLS  <b>61-36455-20</b> 11 12 7 790 054 1,65 mm MLS	<b>14-32004-02</b> 11 12 9 067 792	<b>71-36878-00</b> 11 12 7 794 495	<b>12-35172-01</b> 11 34 9 070 982  <b>70-35172-00</b> 11 34 2 247 171	<b>11-77546-02</b>   <b>71-33109-10</b>  11 61 2 246 944 4x  <b>71-77546-00</b>  11 61 2 246 945 4x  <b>71-33027-00</b>  11 62 7 796 480 2x	<b>71-39298-00</b> 11 13 0 139 259	<b>81-37002-00</b>  11 11 8 604 931 55x68 AB RD PTFE  <b>81-90032-00</b>  11 14 7 787 262





















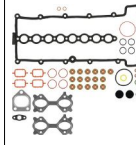



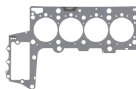

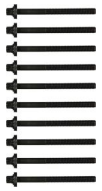

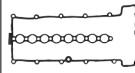
2,0 M47 D20 (204D4) 90 kW (122 PS) 118 d (E87) 06/04-02/07

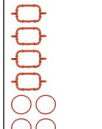
										
	<b>02-36878-01</b> 11 12 7 788 072	<b>08-39298-01</b> 11 11 0 394 505	<b>04-10029-01</b>   <b>71-39447-00</b>  11 14 7 797 491	<b>61-36455-00</b> 11 12 7 790 052 1,45 mm MLS  <b>61-36455-10</b> 11 12 7 790 053 1,55 mm MLS  <b>61-36455-20</b> 11 12 7 790 054 1,65 mm MLS	<b>14-32004-02</b> 11 12 9 067 792	<b>71-36878-00</b> 11 12 7 794 495	<b>12-35172-01</b> 11 34 9 070 982  <b>70-35172-00</b> 11 34 2 247 171	<b>11-77546-02</b>   <b>71-33109-10</b>  11 61 2 246 944 4x  <b>71-77546-00</b>  11 61 2 246 945 4x  <b>71-33027-00</b>  11 62 7 796 480 2x	<b>71-39298-00</b> 11 13 0 139 259	<b>81-37002-00</b>  11 11 8 604 931 55x68 AB RD PTFE  <b>81-90032-00</b>  11 14 7 787 262





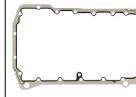





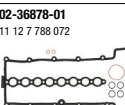

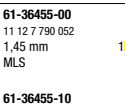
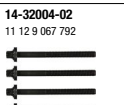
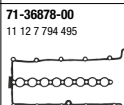
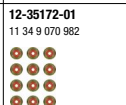
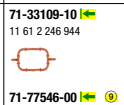
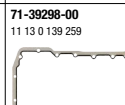

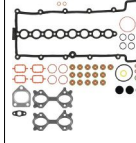



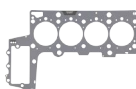



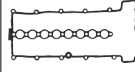



BMW

Ltr.     
 2,0 M47 D20 (204D4) 110 kW (150 PS) 120 d (E87) 06/04-02/07

										
	<p><b>02-36878-01</b> 11 12 7 788 072</p> 	<p><b>08-39298-01</b> 11 11 0 394 505</p> 	<p><b>04-10029-01</b> </p> 	<p><b>61-36455-00</b> 11 12 7 790 052 1,45 mm MLS</p> <p><b>61-36455-10</b> 11 12 7 790 053 1,55 mm MLS</p> <p><b>61-36455-20</b> 11 12 7 790 054 1,65 mm MLS</p> 	<p><b>14-32004-02</b> 11 12 9 067 792</p> <p>1 </p>  <p>2 </p> <p>3 </p>	<p><b>71-36878-00</b> 11 12 7 794 495</p> 	<p><b>12-35172-01</b> 11 34 9 070 982</p>  <p><b>70-35172-00</b> 11 34 2 247 171</p> <p>16x</p>	<p><b>11-77546-02</b> </p>  <p><b>71-33109-10</b> </p> <p>4x 11 61 2 246 944</p> <p><b>71-77546-00</b>  </p> <p>4x 11 61 2 246 945</p> <p><b>71-33027-00</b> </p> <p>2x 11 62 7 796 480</p> 	<p><b>71-39298-00</b> 11 13 0 139 259</p> 	<p><b>81-90032-00</b> </p> <p>11 14 7 787 262</p> 

2,0 M47 D20 (204D4) 115 kW (156 PS) 120 d (E87) 05/06-02/07

										
	<p><b>02-36878-01</b> 11 12 7 788 072</p> 	<p><b>08-39298-01</b> 11 11 0 394 505</p> 	<p><b>04-10029-01</b> </p> 	<p><b>61-36455-00</b> 11 12 7 790 052 1,45 mm MLS</p> <p><b>61-36455-10</b> 11 12 7 790 053 1,55 mm MLS</p> <p><b>61-36455-20</b> 11 12 7 790 054 1,65 mm MLS</p> 	<p><b>14-32004-02</b> 11 12 9 067 792</p> <p>1 </p>  <p>2 </p> <p>3 </p>	<p><b>71-36878-00</b> 11 12 7 794 495</p> 	<p><b>12-35172-01</b> 11 34 9 070 982</p>  <p><b>70-35172-00</b> 11 34 2 247 171</p> <p>16x</p>	<p><b>71-33109-10</b> </p> <p>4x 11 61 2 246 944</p> <p><b>71-77546-00</b>  </p> <p>4x 11 61 2 246 945</p> <p><b>71-37403-00</b> </p> <p>2x 11 62 7 798 177</p> 	<p><b>71-39298-00</b> 11 13 0 139 259</p> 	<p><b>81-37002-00</b> </p> <p>11 11 8 604 931 55x68 AB RD PTFE</p>  <p><b>81-90032-00</b> </p> <p>11 14 7 787 262</p> 

BMW

Ltr.   

2,0 M47 D20 (204D4) 120 kW (163 PS) 320 d (E90) 12/04-10/11

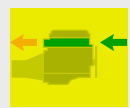

02-36878-01  
11 12 7 788 072

08-39298-01  
11 11 0 394 505  
09/08→

04-10029-01 

61-36455-00  
11 12 7 790 052  
1,45 mm  
MLS

61-36455-10  
11 12 7 790 053  
1,55 mm  
MLS

61-36455-20  
11 12 7 790 054  
1,65 mm  
MLS

14-32004-02  
11 12 9 067 792

71-36878-00  
11 12 7 794 495

12-35172-01  
11 34 9 070 982

71-77546-02  4x

71-39298-00  
11 13 0 139 259

81-37002-00  K  
11 11 8 604 931  
55x68  
AB RD PTFE

81-90032-00  K  
11 14 7 787 262

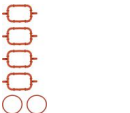
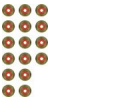
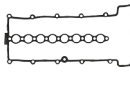
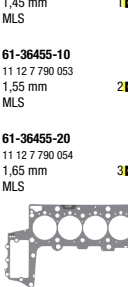
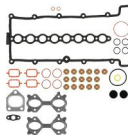

2,0 M50 B20 (206S1) 110 kW (150 PS) 320 i (E36) 04/90-11/98  
520 i (E34)  
520 i 24V (E34)

02-27815-01  
11 12 1 730 252  
09/92

08-27698-02  
11 11 9 064 460

61-31945-00  
11 12 1 726 623  
81 Ø  
1,75 mm

61-31945-10  
11 12 1 726 626  
81 Ø  
2,02 mm

14-32002-02  
11 12 1 721 938

15-28939-01  
11 12 0 034 106  
09/92

12-26058-01  
11 34 9 059 172  
09/92

71-28916-00  6x







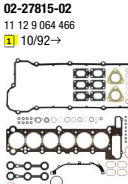
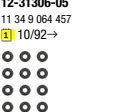
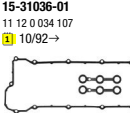
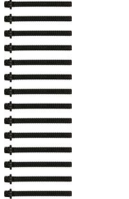
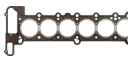
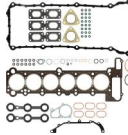







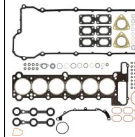

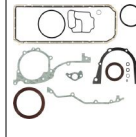



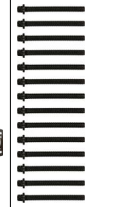

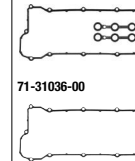

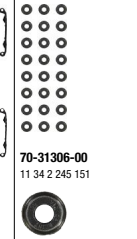







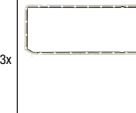





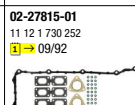

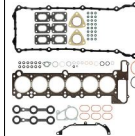

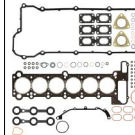

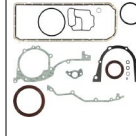

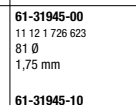
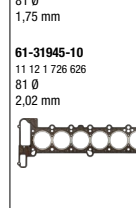
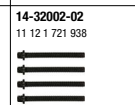



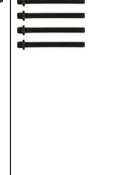

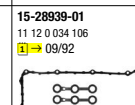

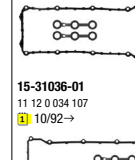

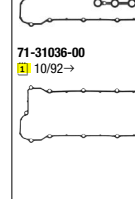



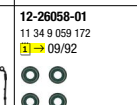



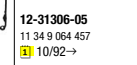







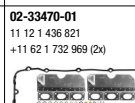
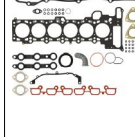
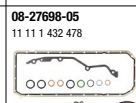



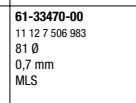
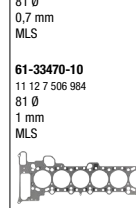
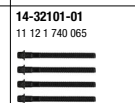



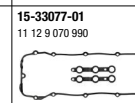
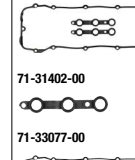

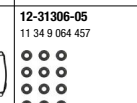

71-27698-10  
11 13 1 437 237

81-17404-00  K  
11 14 1 265 431  
48x65  
AB SL RD FPM



81-20745-40  K  
11 14 2 245 364  
90x110  
A.S.LD FPM

























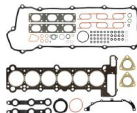



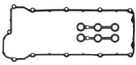

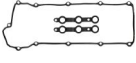





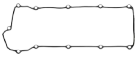







BMW



<p>Ltr.   </p> <p>2,0 M50 B20 (206S2) 110 kW (150 PS) 320i (E36) 12/93-11/99</p>		 <p><b>02-27815-02</b> 11 12 9 064 466</p> 	 <p><b>08-27698-02</b> 11 11 9 064 460</p> 		 <p><b>61-31945-00</b> 11 12 1 726 623 81 Ø 1,75 mm</p> <p><b>61-31945-10</b> 11 12 1 726 626 81 Ø 2,02 mm</p> 	 <p><b>14-32002-02</b> 11 12 1 721 938</p> 	 <p><b>15-31036-01</b> 11 12 0 034 107</p>  <p><b>71-31036-00</b></p> 	 <p><b>12-31306-05</b> 11 34 9 064 457</p>  <p><b>70-31306-00</b> 11 34 2 245 151</p> 	 <p><b>71-28916-00</b>  6x 11 61 1 720 740</p>  <p><b>71-28494-00</b> 3x 11 62 1 728 983</p>  <p><b>71-28913-10</b>  2x 18 11 1 723 692</p> 	 <p><b>71-27698-10</b> 11 13 1 437 237</p> 	 <p><b>81-17404-50</b>  11 14 1 265 431 48x65 AB SL RD FPM</p>  <p><b>81-20745-40</b>  11 14 2 245 364 90x110 A SL LD FPM</p> 
<p>2,0 M50 B20 (206S2) 110 kW (150 PS) 320i (E36) 04/90-11/98 520i (E34) 520i 24V (E34)</p>		 <p><b>02-27815-01</b> 11 12 1 730 252  09/92</p>  <p><b>02-27815-02</b> 11 12 9 064 466  10/92→</p> 	 <p><b>08-27698-02</b> 11 11 9 064 460</p> 	 <p><b>61-31945-00</b> 11 12 1 726 623 81 Ø 1,75 mm</p> <p><b>61-31945-10</b> 11 12 1 726 626 81 Ø 2,02 mm</p> 	 <p><b>14-32002-02</b> 11 12 1 721 938</p> 	 <p><b>15-28939-01</b> 11 12 0 034 106  09/92</p>  <p><b>15-31036-01</b> 11 12 0 034 107  10/92→</p>  <p><b>71-31036-00</b>  10/92→</p> 	 <p><b>12-26058-01</b> 11 34 9 059 172  09/92</p>  <p><b>12-31306-05</b> 11 34 9 064 457  10/92→</p>  <p><b>70-26058-00</b> 11 34 1 288 544  09/92</p>  <p><b>70-31306-00</b> 11 34 2 245 151  10/92→</p> 	 <p><b>71-28916-00</b>  6x 11 61 1 720 740</p>  <p><b>71-28494-00</b> 3x 11 62 1 728 983</p>  <p><b>71-28913-10</b>  2x 18 11 1 723 692</p> 	 <p><b>71-27698-10</b> 11 13 1 437 237</p> 	 <p><b>81-17404-50</b>  11 14 1 265 431 48x65 AB SL RD FPM</p>  <p><b>81-20745-40</b>  11 14 2 245 364 90x110 A SL LD FPM</p> 	
<p>2,0 M52 B20 (206S3) 100-110 kW (136-150 PS) 320 Ci (E46) 01/96-06/03 M52 B20 (206S4) 320i (E46) 520i (E39)</p>		 <p><b>02-33470-01</b> 11 12 1 436 821 +11 62 1 732 969 (2x)</p> 	 <p><b>08-27698-05</b> 11 11 1 432 478</p> 	 <p><b>61-33470-00</b> 11 12 7 506 983 81 Ø 0,7 mm MLS</p> <p><b>61-33470-10</b> 11 12 7 506 984 81 Ø 1 mm MLS</p> 	 <p><b>14-32101-01</b> 11 12 1 740 065</p> 	 <p><b>15-33077-01</b> 11 12 9 070 990</p>  <p><b>71-31402-00</b> 2x</p>  <p><b>71-33077-00</b></p> 	 <p><b>12-31306-05</b> 11 34 9 064 457</p>  <p><b>70-31306-00</b> 11 34 2 245 151</p> 	 <p><b>11-33074-01</b>  11 61 1 436 631</p>  <p><b>71-34834-00</b> 2x 11 62 1 732 969</p>  <p><b>71-28913-10</b>  2x 18 11 1 723 692</p> 	 <p><b>71-27698-10</b> 11 13 1 437 237</p> 	 <p><b>81-17404-50</b>  11 14 1 265 431 48x65 AB SL RD FPM</p>  <p><b>81-20745-40</b>  11 14 2 245 364 90x110 A SL LD FPM</p> 	























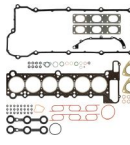

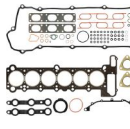













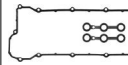

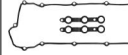

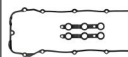



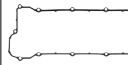

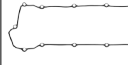



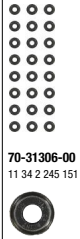











BMW

Ltr.     
 2,0 M52 B20 (206S3) 110 kW (150 PS) 320i (E36) 01/91-02/98



										
	<p><b>02-31945-01</b> 11 12 1 740 982  09/95</p>  <p><b>02-31945-02</b> 11 12 1 427 825  10/95→</p> 	<p><b>08-27698-03</b> 11 11 1 740 981</p> 		<p><b>61-31945-00</b> 11 12 1 726 623 81 Ø 1,75 mm</p> <p><b>61-31945-10</b> 11 12 1 726 626 81 Ø 2,02 mm</p> 	<p><b>14-32101-01</b> 11 12 1 740 065</p> 	<p><b>15-31036-01</b> 11 12 0 034 107  09/95</p>  <p><b>15-31401-01</b> 11 12 0 034 108  10/95→</p>  <p><b>71-28940-00</b> 2x  09/95</p>  <p><b>71-31036-00</b>  09/95</p>  <p><b>71-31401-00</b>  10/95→</p>  <p><b>71-31402-00</b> 2x  10/95→</p> 	<p><b>12-31306-05</b> 11 34 9 064 457</p>  <p><b>70-31306-00</b> 11 34 2 245 151</p>  <p>24x</p>	<p><b>71-31403-00</b>  2x 11 61 1 740 069</p>  <p><b>71-31404-00</b> 2x 11 62 1 744 252</p>  <p><b>71-28913-10</b>   2x 18 11 1 723 692</p> 	<p><b>71-27698-10</b> 11 13 1 437 237</p> 	<p><b>81-17404-50</b>  11 14 1 265 431 48x65 AB SL RD FPM</p>  <p><b>81-20745-40</b>  11 14 2 245 364 90x110 A SL LD FPM</p> 



















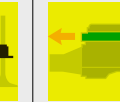
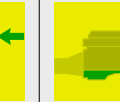
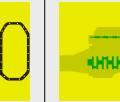

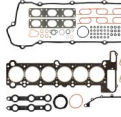











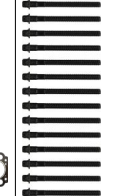

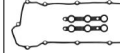







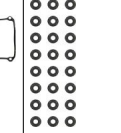











BMW

Ltr.  2,0 M52 B20 (206S3) 110 kW (150 PS) 320i (E36)  12/91-11/99 















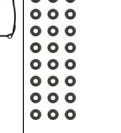

										
	<p><b>02-31945-01</b> 11 12 1 740 982  09/95</p>  <p><b>02-31945-02</b> 11 12 1 427 825  10/95 →  09/98</p>  <p><b>02-33470-01</b> 11 12 1 436 821 +11 62 1 732 969 (2x)  10/98 →</p> 	<p><b>08-27698-03</b> 11 11 1 740 981  09/98</p>  <p><b>08-27698-05</b> 11 11 1 432 478  10/98 →</p> 		<p><b>61-31945-00</b> 11 12 1 726 623 81 Ø 1,75 mm  09/98</p> <p><b>61-31945-10</b> 11 12 1 726 626 81 Ø 2,02 mm  09/98</p>  <p><b>61-33470-00</b> 11 12 7 506 983 81 Ø 0,7 mm MLS  10/98 →</p> <p><b>61-33470-10</b> 11 12 7 506 984 81 Ø 1 mm MLS  10/98 →</p> 	<p><b>14-32101-01</b> 11 12 1 740 065</p> 	<p><b>15-31036-01</b> 11 12 0 034 107  09/95</p>  <p><b>15-31401-01</b> 11 12 0 034 108  10/95 →  09/98</p>  <p><b>15-33077-01</b> 11 12 0 070 990  10/98 →</p>  <p><b>71-28940-00</b> 2x  09/95</p>  <p><b>71-31036-00</b>  09/95</p>  <p><b>71-31401-00</b>  10/95 →  09/98</p>  <p><b>71-31402-00</b> 2x  10/95 →</p>  <p><b>71-33077-00</b>  10/98 →</p> 	<p><b>12-31306-05</b> 11 34 9 064 457</p>  <p><b>70-31306-00</b> 11 34 2 245 151</p> 	<p><b>11-33074-01</b>   11 61 1 436 631  10/98 →</p>  <p><b>71-31403-00</b>  2x 11 61 1 740 069  09/98</p>  <p><b>71-31404-00</b>  2x 11 62 1 744 252  09/98</p>  <p><b>71-34834-00</b>  2x 11 62 1 732 969  10/98 →</p>  <p><b>71-28913-10</b>   2x 18 11 1 723 692</p> 	<p><b>71-27698-10</b> 11 13 1 437 237</p> 	<p><b>81-17404-50 K</b>  11 14 1 265 431 48x65 AB SL RD FPM</p>  <p><b>81-20745-40 K</b>  11 14 2 245 364 90x110 A SL LD FPM</p> 

BMW



Ltr.     
 2,0 M52 B20 (206S3) 110 kW (150 PS) 520 i (E39) 01/96-06/03













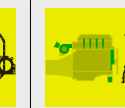

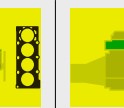

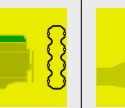
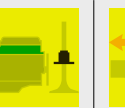
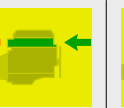

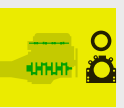

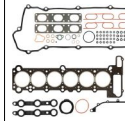



















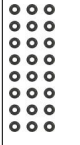













										
	<p><b>02-31945-02</b> 11 12 1 427 825  09/98</p>  <p><b>02-33470-01</b> 11 12 1 436 821 +11 62 1 732 969 (2x)  10/98→</p> 	<p><b>08-27698-03</b> 11 11 1 740 981  09/98</p>  <p><b>08-27698-05</b> 11 11 1 432 478  10/98→</p> 		<p><b>61-31945-00</b> 11 12 1 726 623 81 Ø 1,75 mm  09/98</p> <p><b>61-31945-10</b> 11 12 1 726 626 81 Ø 2,02 mm  09/98</p>  <p><b>61-33470-00</b> 11 12 7 506 983 81 Ø 0,7 mm MLS  10/98→</p> <p><b>61-33470-10</b> 11 12 7 506 984 81 Ø 1 mm MLS  10/98→</p> 	<p><b>14-32101-01</b> 11 12 1 740 065</p> 	<p><b>15-31401-01</b> 11 12 0 034 108  09/98</p>  <p><b>15-33077-01</b> 11 12 9 070 990  10/98→</p>  <p><b>71-31401-00</b>  09/98</p>  <p><b>71-33077-00</b>  10/98→</p>  <p><b>71-31402-00</b> 2x</p> 	<p><b>12-31306-05</b> 11 34 9 064 457</p>  <p><b>70-31306-00</b> 24x 11 34 2 245 151</p> 	<p><b>11-33074-01</b>  11 61 1 436 631  10/98→</p>  <p><b>71-31403-00</b>  2x 11 61 1 740 069  09/98</p>  <p><b>71-31404-00</b>  2x 11 62 1 744 252  10/98→</p>  <p><b>71-34834-00</b>  2x 11 62 1 732 969  10/98→</p>  <p><b>71-28913-10</b>   2x 18 11 1 723 692</p> 	<p><b>71-27698-10</b> 11 13 1 437 237</p> 	<p><b>81-17404-50</b>  11 14 1 265 431 48x65 AB SL RD FPM</p>  <p><b>81-20745-40</b>  11 14 2 245 364 90x110 A SL LD FPM</p> 

2,0 M52 B20 (206S4) 110 kW (150 PS) Z3 2.0 (E36) 04/99-01/03











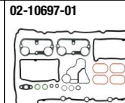
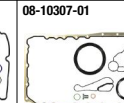

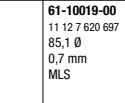
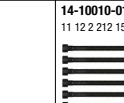
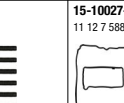
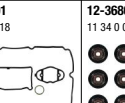

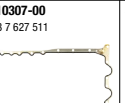
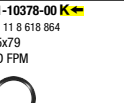
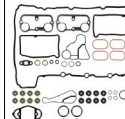
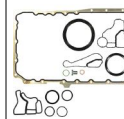

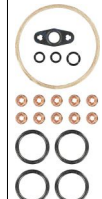

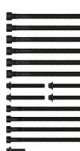
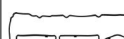
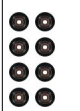

	<p><b>02-33470-01</b> 11 12 1 436 821 +11 62 1 732 969 (2x)</p> 	<p><b>08-27698-05</b> 11 11 1 432 478</p> 	<p><b>61-33470-00</b> 11 12 7 506 983 81 Ø 0,7 mm MLS</p> <p><b>61-33470-10</b> 11 12 7 506 984 81 Ø 1 mm MLS</p> 	<p><b>14-32101-01</b> 11 12 1 740 065</p> 	<p><b>15-33077-01</b> 11 12 9 070 990</p> 	<p><b>12-31306-05</b> 11 34 9 064 457</p>  <p><b>70-31306-00</b> 24x 11 34 2 245 151</p> 	<p><b>11-33074-01</b>  11 61 1 436 631</p>  <p><b>71-28913-10</b>   2x 18 11 1 723 692</p> 	<p><b>71-27698-10</b> 11 13 1 437 237</p> 	<p><b>81-17404-50</b>  11 14 1 265 431 48x65 AB SL RD FPM</p>  <p><b>81-20745-40</b>  11 14 2 245 364 90x110 A SL LD FPM</p> 
--	---	--	---	---	---	--	--	---	--

BMW

Ltr.  M52 B20 (206S4) 110 kW (150 PS)  320i (E46)  03/98-09/00

											
	<p><b>02-31945-02</b> 11 12 1 427 825  09/98</p>  <p><b>02-33470-01</b> 11 12 1 436 821 +11 62 1 732 969 (2x)  10/98→</p> 	<p><b>08-27698-03</b> 11 11 1 740 981  09/98</p>  <p><b>08-27698-05</b> 11 11 1 432 478  10/98→</p> 		<p><b>61-31945-00</b> 11 12 1 726 623 81 Ø 1,75 mm  09/98</p> <p><b>61-31945-10</b> 11 12 1 726 626 81 Ø 2,02 mm  09/98</p>  <p><b>61-33470-00</b> 11 12 7 506 983 81 Ø 0,7 mm MLS  10/98→</p> <p><b>61-33470-10</b> 11 12 7 506 984 81 Ø 1 mm MLS  10/98→</p> 	<p><b>14-32101-01</b> 11 12 1 740 065</p> 	<p><b>15-31401-01</b> 11 12 0 034 108  09/98</p>  <p><b>15-33077-01</b> 11 12 9 070 990  10/98→</p>  <p><b>71-31401-00</b>  09/98</p> 	<p><b>12-31306-05</b> 11 34 9 064 457</p>  <p><b>70-31306-00</b> 11 34 2 245 151</p> 	<p><b>11-33074-01</b>  </p> <p>11 61 1 436 631  10/98→</p>  <p><b>71-31403-00</b> </p> <p>11 61 1 740 069  09/98</p>  <p><b>71-31404-00</b> </p> <p>11 62 1 744 252  09/98</p>  <p><b>71-34834-00</b> </p> <p>11 62 1 732 969  10/98→</p>  <p><b>71-28913-10</b>  </p> <p>18 11 1 723 692</p> 	<p><b>71-27698-10</b> 11 13 1 437 237</p> 	<p><b>81-17404-50</b>  </p> <p>11 14 1 265 431 48x65 AB SL RD FPM</p>  <p><b>81-20745-40</b>  </p> <p>11 14 2 245 364 90x110 A SL LD FPM</p> 	

2,0 N20 B20 A 115-230 kW (156-313 PS) X1 sDrive 20 i (E84) 10/10-06/21  
 X1 xDrive 20 i (E84)  
 X1 xDrive 28 i (E84)  
 X3 sDrive 20 i (F25)  
 X3 2.0 i (F25)  
 X3 2.8 i (F25)  
 X4 xDrive 20 i (F26)  
 X4 xDrive 28 i (F26)  
 X5 xDrive 40e (F15, F85)  
 Z4 sDrive 20 i (E89)  
 Z4 1.8 i (E89)  
 Z4 2.0 i (E89)  
 Z4 2.8 i (E89)  
 125i (F20)  
 220i (F22, F87)  
 228i (F22, F87)  
 228i (F23)  
 320i (F30)  
 320i (F34)  
 320i xDrive (F30, F80)  
 328i (F30)  
 328i (F31)  
 328i (F34)  
 428i (F32)  
 428i (F33, F83)  
 428i (F36)  
 428i xDrive (F33, F83)  
 428i xDrive (F36)  
 520i (F10)  
 520i (F11)  
 528i (F07)  
 528i (F10)  
 528i (F11)

											
	<p><b>02-10697-01</b></p> 	<p><b>08-10307-01</b></p> 	<p><b>04-10357-01</b> </p> 	<p><b>61-10019-00</b> 11 12 7 620 697 85,1 Ø 0,7 mm MLS</p> <p><b>61-10019-10</b> 11 12 7 620 698 85,1 Ø 1 mm MLS</p> 	<p><b>14-10010-01</b> 11 12 2 212 157</p> 	<p><b>15-10027-01</b> 11 12 7 588 418</p> 	<p><b>12-36866-03</b> 11 34 0 038 719</p>  <p><b>12-37256-03</b> 11 34 0 038 720</p> 	<p><b>11-10000-01</b> </p> <p>11 61 2 212 759</p>  <p><b>71-10306-00</b> </p> <p>11 65 7 625 293</p> 	<p><b>71-10307-00</b> 11 13 7 627 511</p> 	<p><b>81-10378-00</b>  </p> <p>11 11 8 618 864 65x79 RD FPM</p>  <p><b>81-40292-00</b>  </p> <p>11 11 7 587 168 90x110 A LD FPM</p> 	

BMW

















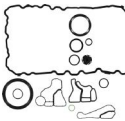

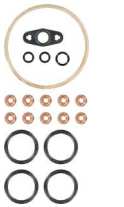

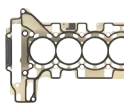









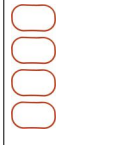









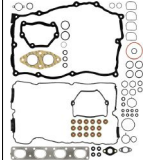



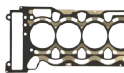



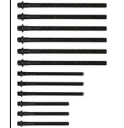

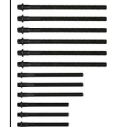
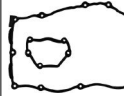
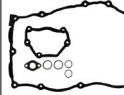



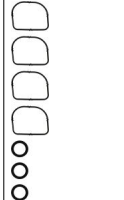

Ltr.													
2,0	N20 B20 A	120-135 kW (163-184 PS)	220 i (F23) 320 i (F34) 320 i xDrive (F34) 420 i (F32) 420 i (F32, F82) 420 i xDrive (F32, F82) 520 i (F11)	09/11-06/21									
2,0	N20 B20 A	135-160 kW (184-218 PS)	120 i Active Flex (F20) 125 i Active Flex (F20) 125 i Active Flex (F21)	08/14				<p><b>61-10019-00</b> 11 12 7 620 697 85,1 Ø 0,7 mm MLS 02/16</p> <p><b>61-10019-10</b> 11 12 7 620 698 85,1 Ø 1 mm MLS 02/16</p> <p></p> <p><b>61-10208-00</b> 11 12 8 676 519 84 Ø 0,7 mm MLS 03/16→</p> <p><b>61-10208-10</b> 11 12 8 676 514 84 Ø 1 mm MLS 03/16→</p> <p></p>			<p><b>12-36866-03</b> 11 34 0 038 719</p> <p><b>12-37256-03</b> 11 34 0 038 720</p> <p></p> <p><b>11-10000-01</b> 4x 11 61 2 212 759</p> <p><b>71-10306-00</b> 11 65 7 625 293</p>		<p><b>81-10378-00 K</b> 11 11 8 618 864 65x79 RD FPM</p> <p><b>81-40292-00 K</b> 11 11 7 587 168 90x110 A LD FPM</p> <p></p>
2,0	N20 B20 A N20 B20 D	135-180 kW (184-245 PS)	X6 xDrive 28 i (F16, F86) 320 i (F30)	03/12-07/19				<p><b>61-10019-00</b> 11 12 7 620 697 85,1 Ø 0,7 mm MLS</p> <p><b>61-10019-10</b> 11 12 7 620 698 85,1 Ø 1 mm MLS</p> <p></p>			<p><b>12-36866-03</b> 11 34 0 038 719</p> <p><b>12-37256-03</b> 11 34 0 038 720</p> <p></p> <p><b>11-10000-01</b> 4x 11 61 2 212 759</p> <p><b>71-10306-00</b> 11 65 7 625 293</p>		<p><b>81-10378-00 K</b> 11 11 8 618 864 65x79 RD FPM</p> <p><b>81-40292-00 K</b> 11 11 7 587 168 90x110 A LD FPM</p> <p></p>



BMW

Ltr.																		
2,0	N20 B20 A	160-175 kW (218-238 PS)	125i (F21)	12/11		<b>02-10697-01</b> 	<b>08-10307-01</b> 	<b>04-10357-01</b> 	<b>61-10019-00</b> 11 12 7 620 697 85,1 Ø 0,7 mm MLS ⇒ 02/16  <b>61-10019-10</b> 11 12 7 620 698 85,1 Ø 1 mm MLS ⇒ 02/16  	<b>14-10010-01</b> 11 12 2 212 157  	<b>15-10027-01</b> 11 12 7 588 418  	<b>12-36866-03</b> 11 34 0 038 719  	<b>12-37256-03</b> 11 34 0 038 720  	<b>11-10000-01</b> 11 61 2 212 759  	<b>71-10306-00</b> 4x 11 65 7 625 293  	<b>71-10307-00</b> 11 13 7 627 511  	<b>81-10378-00 K</b> 11 11 8 618 864 65x79 RD FPM  	<b>81-40292-00 K</b> 11 11 7 587 168 90x110 A LD FPM  
2,0	N20 B20 A	180 kW (245 PS)	X5 xDrive 28 i (F15, F85)	06/15-07/18		<b>08-10307-01</b> 	<b>04-10357-01</b> 	<b>61-10019-00</b> 11 12 7 620 697 85,1 Ø 0,7 mm MLS ⇒ 02/16  <b>61-10019-10</b> 11 12 7 620 698 85,1 Ø 1 mm MLS ⇒ 02/16  	<b>14-10010-01</b> 11 12 2 212 157  	<b>15-10027-01</b> 11 12 7 588 418  	<b>12-36866-03</b> 11 34 0 038 719  	<b>12-37256-03</b> 11 34 0 038 720  	<b>11-10000-01</b> 11 61 2 212 759  	<b>71-10306-00</b> 4x 11 65 7 625 293  	<b>71-10307-00</b> 11 13 7 627 511  	<b>81-10378-00 K</b> 11 11 8 618 864 65x79 RD FPM  	<b>81-40292-00 K</b> 11 11 7 587 168 90x110 A LD FPM  	
2,0	N20 B20 B	120 kW (163 PS)	320i xDrive (F31)	03/13-06/15	<b>02-10697-01</b> 		<b>04-10357-01</b> 	<b>61-10019-00</b> 11 12 7 620 697 85,1 Ø 0,7 mm MLS  <b>61-10019-10</b> 11 12 7 620 698 85,1 Ø 1 mm MLS  	<b>14-10010-01</b> 11 12 2 212 157  	<b>15-10027-01</b> 11 12 7 588 418  	<b>12-36866-03</b> 11 34 0 038 719  	<b>12-37256-03</b> 11 34 0 038 720  	<b>11-10000-01</b> 11 61 2 212 759  	<b>71-10306-00</b> 4x 11 65 7 625 293  	<b>71-10307-00</b> 11 13 7 627 511  	<b>81-10378-00 K</b> 11 11 8 618 864 65x79 RD FPM  	<b>81-40292-00 K</b> 11 11 7 587 168 90x110 A LD FPM  	
2,0	N20 B20 B	120-135 kW (163-184 PS)	220i (F22, F87) 320i (F30) 320i (F31) 420i (F33, F83) 420i (F36) 420i xDrive (F36) 520i (F10)	09/11-06/21	<b>02-10697-01</b> 	<b>08-10308-01</b> 	<b>04-10357-01</b> 	<b>61-10019-00</b> 11 12 7 620 697 85,1 Ø 0,7 mm MLS  <b>61-10019-10</b> 11 12 7 620 698 85,1 Ø 1 mm MLS  	<b>14-10010-01</b> 11 12 2 212 157  	<b>15-10027-01</b> 11 12 7 588 418  	<b>12-36866-03</b> 11 34 0 038 719  	<b>12-37256-03</b> 11 34 0 038 720  	<b>11-10000-01</b> 11 61 2 212 759  	<b>71-10306-00</b> 4x 11 65 7 625 293  	<b>71-10308-00</b> 11 13 7 627 512  	<b>81-10378-00 K</b> 11 11 8 618 864 65x79 RD FPM  	<b>81-40292-00 K</b> 11 11 7 587 168 90x110 A LD FPM  	

BMW

<p>Ltr.   </p> <p>2,0 N20 B20 B N26 B20 A</p> <p>120-180 kW (163-245 PS)</p> <p>220i (F23) 228i (F22, F87) 320i (F34) 320i xDrive (F34) 328i (F30) 420i (F32) 420i (F32, F82) 420i xDrive (F32, F82) 428i (F32) 428i (F33, F83) 520i (F11)</p> <p>09/11-06/21</p>			 <p><b>08-10308-01</b></p> 	 <p><b>04-10357-01</b> </p> 	 <p><b>61-10019-00</b> 11 12 7 620 697 85,1 Ø 0,7 mm MLS</p> <p><b>61-10019-10</b> 11 12 7 620 698 85,1 Ø 1 mm MLS</p> 	 <p><b>14-10010-01</b> 11 12 2 212 157</p> 	 <p><b>15-10027-01</b> 11 12 7 588 418</p> 	 <p><b>12-36866-03</b> 11 34 0 038 719</p>  <p><b>12-37256-03</b> 11 34 0 038 720</p> 	 <p><b>11-10000-01</b> </p>  <p><b>71-10306-00</b>  4x</p> 	 <p><b>71-10308-00</b> 11 13 7 627 512</p> 	 <p><b>81-10378-00</b> </p>  <p>11 11 8 618 864 65x79 RD FPM</p> <p><b>81-40292-00</b> </p>  <p>11 11 7 587 168 90x110 A LD FPM</p>
<p>2,0 N42 B20</p> <p>105 kW (143 PS)</p>		<p><b>02-37293-01</b> 11 12 0 308 857</p> 	<p><b>08-34056-01</b> 11 11 7 511 529</p> 	<p><b>61-36255-00</b> 11 12 7 509 710 0,4 mm MLS  ⇒ 01/07</p> <p><b>61-36255-10</b> 11 12 7 509 711 0,7 mm MLS  ⇒ 01/07</p>  <p><b>61-37625-00</b> 11 12 7 563 412 85 Ø 0,5 mm MLS  02/07→</p> <p><b>61-37625-10</b> 11 12 7 578 093 85 Ø 0,8 mm MLS  02/07→</p> 	<p><b>14-32314-01</b> 11 12 7 511 534  ⇒ 01/07</p>  <p><b>14-32310-01</b> 11 12 7 578 077  02/07→</p> 	<p><b>15-37293-01</b> 11 12 0 032 224</p>  <p><b>15-37293-03</b> 11 12 0 032 224 +11 37 7 514 007 +11 37 7 514 008 +11 37 7 502 022</p> 	<p><b>12-37281-01</b> 11 34 0 054 492</p>  <p><b>70-37281-00</b> 11 34 7 505 417</p> 	<p><b>11-37282-01</b> </p>  <p>16x</p> <p><b>71-37279-00</b> </p>  <p><b>71-37278-00</b>  </p> 	<p><b>71-34056-00</b> 11 13 7 511 224</p> 	<p><b>81-34057-00</b> </p>  <p>11 11 7 547 842 65x79 A SL RD PTFE ACM</p> <p><b>81-20745-00</b> </p>  <p>11 14 2 249 533 90x110 AB SL LD PTFE (Polytetrafluorethylen)/ACM (Polyacryl-Kautschuk)</p> 	

BMW

Ltr.	Motor	Power	Model	Year	Image 1	Image 2	Image 3	Image 4	Image 5	Image 6	Image 7	Image 8	Image 9	Image 10	Image 11	Image 12
2,0	N42 B20 A	100 kW (136 PS)	318 Ci (E46)	12/00-05/06												
						<p><b>02-37293-02</b> 11 12 0 391 974 +11 34 0 029 751</p>	<p><b>08-34056-01</b> 11 11 7 511 529</p>		<p><b>61-36255-00</b> 11 12 7 509 710 0,4 mm MLS</p> <p><b>61-36255-10</b> 11 12 7 509 711 0,7 mm MLS</p>	<p><b>14-32314-01</b> 11 12 7 511 534</p>	<p><b>15-37293-01</b> 11 12 0 032 224</p>	<p><b>12-37281-01</b> 11 34 0 054 492</p> <p><b>70-37281-00</b> 11 34 7 505 417</p> <p>16x</p>	<p><b>11-37282-01</b> </p> <p>11 61 7 530 703</p>	<p><b>71-34056-00</b> 11 13 7 511 224</p>	<p><b>81-34057-00 K</b> </p> <p>11 11 7 547 842 65x79 A SL RD PTFE ACM</p> <p><b>81-20745-00 K</b> </p> <p>11 14 2 249 533 90x110 AB SL LD PTFE (Polytetrafluorethylen)/ACM (Polyacryl-Kautschuk)</p>	
2,0	N42 B20 A	100 kW (136 PS)	318 Ci (E46)	12/00-08/06		<p><b>02-37293-02</b> 11 12 0 391 974 +11 34 0 029 751</p>	<p><b>08-34056-01</b> 11 11 7 511 529</p>		<p><b>61-36255-00</b> 11 12 7 509 710 0,4 mm MLS</p> <p><b>61-36255-10</b> 11 12 7 509 711 0,7 mm MLS</p>	<p><b>14-32314-01</b> 11 12 7 511 534</p>	<p><b>15-37293-01</b> 11 12 0 032 224</p>	<p><b>12-37281-01</b> 11 34 0 054 492</p> <p><b>70-37281-00</b> 11 34 7 505 417</p> <p>16x</p>	<p><b>11-37284-01</b> </p> <p>11 61 7 528 584</p>	<p><b>71-34056-00</b> 11 13 7 511 224</p>	<p><b>81-34057-00 K</b> </p> <p>11 11 7 547 842 65x79 A SL RD PTFE ACM</p> <p><b>81-20745-00 K</b> </p> <p>11 14 2 249 533 90x110 AB SL LD PTFE (Polytetrafluorethylen)/ACM (Polyacryl-Kautschuk)</p>	
2,0	N42 B20 A	100 kW (136 PS)	318 i (E46)	09/01-02/05		<p><b>02-37293-01</b> 11 12 0 308 857</p>	<p><b>08-34056-01</b> 11 11 7 511 529</p>		<p><b>61-36255-00</b> 11 12 7 509 710 0,4 mm MLS</p> <p><b>61-36255-10</b> 11 12 7 509 711 0,7 mm MLS</p>	<p><b>14-32314-01</b> 11 12 7 511 534</p>	<p><b>15-37293-01</b> 11 12 0 032 224</p>	<p><b>12-37281-01</b> 11 34 0 054 492</p> <p><b>70-37281-00</b> 11 34 7 505 417</p> <p>16x</p>		<p><b>71-34056-00</b> 11 13 7 511 224</p>	<p><b>81-34057-00 K</b> </p> <p>11 11 7 547 842 65x79 A SL RD PTFE ACM</p> <p><b>81-20745-00 K</b> </p> <p>11 14 2 249 533 90x110 AB SL LD PTFE (Polytetrafluorethylen)/ACM (Polyacryl-Kautschuk)</p>	

BMW

Ltr.	Motor	Power	Model	Year	Image 1	Image 2	Image 3	Image 4	Image 5	Image 6	Image 7	Image 8	Image 9	Image 10	Image 11	Image 12
2,0	N42 B20 A	100 kW (136 PS)	318 ti (E46)	03/01-12/04												
						<b>02-37293-01</b> 11 12 0 308 857  	<b>08-34056-01</b> 11 11 7 511 529  		<b>61-36255-00</b> 11 12 7 509 710 0,4 mm MLS  <b>61-36255-10</b> 11 12 7 509 711 0,7 mm MLS 	<b>14-32314-01</b> 11 12 7 511 534  	<b>15-37293-01</b> 11 12 0 032 224    <b>15-37293-03</b> 11 12 0 032 224 +11 37 7 514 007 +11 37 7 514 008 +11 37 7 502 022  	<b>12-37281-01</b> 11 34 0 054 492   16x   <b>70-37281-00</b> 11 34 7 505 417  	<b>11-37282-01</b> 11 61 7 530 703     <b>71-37286-00</b> 18 30 7 540 797  	<b>71-34056-00</b> 11 13 7 511 224  	<b>81-34057-00 K</b> 11 11 7 547 842 65x79 A SL RD PTFE ACM   <b>81-20745-00 K</b> 11 14 2 249 533 90x110 AB SL LD PTFE (Polytetrafluorethylen)/ACM (Polyacryl-Kautschuk)  	
2,0	N42 B20 A	105 kW (143 PS)	318 Ci (E46)	09/01-12/07												
						<b>02-37293-02</b> 11 12 0 391 974 +11 34 0 029 751  	<b>08-34056-01</b> 11 11 7 511 529  		<b>61-36255-00</b> 11 12 7 509 710 0,4 mm MLS $\Rightarrow$ 01/07  <b>61-36255-10</b> 11 12 7 509 711 0,7 mm MLS $\Rightarrow$ 01/07 	<b>14-32314-01</b> 11 12 7 511 534 $\Rightarrow$ 01/07  	<b>15-37293-01</b> 11 12 0 032 224    <b>15-37293-03</b> 11 12 0 032 224 +11 37 7 514 007 +11 37 7 514 008 +11 37 7 502 022  	<b>12-37281-01</b> 11 34 0 054 492   16x   <b>70-37281-00</b> 11 34 7 505 417  	<b>11-37284-01</b> 11 61 7 528 584     <b>71-37286-00</b> 18 30 7 540 797  	<b>71-34056-00</b> 11 13 7 511 224  	<b>81-34057-00 K</b> 11 11 7 547 842 65x79 A SL RD PTFE ACM   <b>81-20745-00 K</b> 11 14 2 249 533 90x110 AB SL LD PTFE (Polytetrafluorethylen)/ACM (Polyacryl-Kautschuk)  	
2,0	N42 B20 A	105 kW (143 PS)	318 Ci (E46) 318 i (E46) 318 ti (E46)	03/01-07/05												
						<b>02-37293-02</b> 11 12 0 391 974 +11 34 0 029 751  	<b>08-34056-01</b> 11 11 7 511 529  		<b>61-36255-00</b> 11 12 7 509 710 0,4 mm MLS  <b>61-36255-10</b> 11 12 7 509 711 0,7 mm MLS 	<b>14-32314-01</b> 11 12 7 511 534  	<b>15-37293-01</b> 11 12 0 032 224    <b>15-37293-03</b> 11 12 0 032 224 +11 37 7 514 007 +11 37 7 514 008 +11 37 7 502 022  	<b>12-37281-01</b> 11 34 0 054 492   16x   <b>70-37281-00</b> 11 34 7 505 417  	<b>11-37284-01</b> 11 61 7 528 584     <b>71-37286-00</b> 18 30 7 540 797  	<b>71-34056-00</b> 11 13 7 511 224  	<b>81-34057-00 K</b> 11 11 7 547 842 65x79 A SL RD PTFE ACM   <b>81-20745-00 K</b> 11 14 2 249 533 90x110 AB SL LD PTFE (Polytetrafluorethylen)/ACM (Polyacryl-Kautschuk)  	

BMW

Ltr.													
2,0	N42 B20 B N46 B20 B	95-110 kW (129-150 PS)	X3 2.0 i (E83) Z4 2.0 i (E85) 118 i (E81) 118 i (E87) 120 i (E87) 318 i (E90) 318 i (E91) 320 i (E90)	06/04									
					<p><b>02-37293-02</b> 11 12 0 391 974 +11 34 0 029 751</p>	<p><b>08-34056-01</b> 11 11 7 511 529</p>	<p><b>61-36255-00</b> 11 12 7 509 710 0,4 mm MLS ☞ ⇒ 01/07</p> <p><b>61-36255-10</b> 11 12 7 509 711 0,7 mm MLS ☞ ⇒ 01/07</p> <p><b>61-37625-00</b> 11 12 7 563 412 85 Ø 0,5 mm MLS ☞ 02/07→</p> <p><b>61-37625-10</b> 11 12 7 578 093 85 Ø 0,8 mm MLS ☞ 02/07→</p>	<p><b>14-32314-01</b> 11 12 7 511 534 ☞ ⇒ 01/07</p> <p><b>14-32310-01</b> 11 12 7 578 077 ☞ 02/07→</p>	<p><b>15-37293-01</b> 11 12 0 032 224</p> <p><b>15-37293-03</b> 11 12 0 032 224 +11 37 7 514 007 +11 37 7 514 008 +11 37 7 502 022</p>	<p><b>12-37281-01</b> 11 34 0 054 492</p> <p><b>70-37281-00</b> 11 34 7 505 417</p> <p>16x</p> <p><b>71-37286-00</b> 18 30 7 540 797</p> <p><b>71-37287-00</b> ☞ 06 18 30 7 540 798</p>	<p><b>11-37284-01</b> ☞ 11 61 7 528 584</p> <p><b>71-37286-00</b> ☞ 18 30 7 540 797</p> <p><b>71-37287-00</b> ☞ 06 18 30 7 540 798</p>	<p><b>71-34056-00</b> 11 13 7 511 224</p>	<p><b>81-34057-00</b> ☞ 11 11 7 547 842 65x79 A SL RD PTFE ACM</p> <p><b>81-20745-00</b> ☞ 11 14 2 249 533 90x110 AB SL LD PTFE (Polytetrafluorethylen)/ACM (Polyacryl-Kautschuk)</p>
2,0	N43 B20 A	90-105 kW (122-143 PS)	116 i (E81, E87) 116 i (E87) 118 i (E81, E87) 118 i (E87) 118 i (E88) 318 i (E90) 318 i (E91) 318 i (E92) 318 i (E93)	09/06-12/13									
					<p><b>02-37625-01</b></p>	<p><b>08-34056-01</b> 11 11 7 511 529</p>	<p><b>61-37625-00</b> 11 12 7 563 412 85 Ø 0,5 mm MLS</p> <p><b>61-37625-10</b> 11 12 7 578 093 85 Ø 0,8 mm MLS</p>	<p><b>14-32310-01</b> 11 12 7 578 077</p>	<p><b>15-41338-01</b></p> <p><b>71-41338-00</b> 11 12 7 555 738</p>	<p><b>12-37256-02</b> 11 34 0 035 888</p>	<p><b>11-41336-01</b> ☞ 11 61 7 546 983</p> <p><b>71-37134-00</b> ☞ 4x 18 40 7 530 606</p> <p><b>71-41337-00</b> ☞ 06 18 30 7 566 564</p>	<p><b>71-34056-00</b> 11 13 7 511 224</p>	<p><b>81-34057-00</b> ☞ 11 11 7 547 842 65x79 A SL RD PTFE ACM</p> <p><b>81-20745-00</b> ☞ 11 14 2 249 533 90x110 AB SL LD PTFE (Polytetrafluorethylen)/ACM (Polyacryl-Kautschuk)</p>
2,0	N43 B20 A	120-125 kW (163-170 PS)	118 i (E87) 120 i (E81, E87) 120 i (E82) 120 i (E87) 120 i (E88) 120 i (E88) 320 i (E90) 320 i (E91) 320 i (E92) 320 i (E93) 320 i (E93) 520 i (E60) 520 i (E61)	09/06-12/13									
					<p><b>02-37625-01</b></p>	<p><b>08-34056-01</b> 11 11 7 511 529</p>	<p><b>61-37625-00</b> 11 12 7 563 412 85 Ø 0,5 mm MLS</p> <p><b>61-37625-10</b> 11 12 7 578 093 85 Ø 0,8 mm MLS</p>	<p><b>14-32310-01</b> 11 12 7 578 077</p>	<p><b>15-41338-01</b></p> <p><b>71-41338-00</b> 11 12 7 555 738</p>	<p><b>12-37256-02</b> 11 34 0 035 888</p>	<p><b>11-41336-01</b> ☞ 11 61 7 546 983</p> <p><b>71-37134-00</b> ☞ 4x 18 40 7 530 606</p>	<p><b>71-34056-00</b> 11 13 7 511 224</p>	<p><b>81-34057-00</b> ☞ 11 11 7 547 842 65x79 A SL RD PTFE ACM</p> <p><b>81-20745-00</b> ☞ 11 14 2 249 533 90x110 AB SL LD PTFE (Polytetrafluorethylen)/ACM (Polyacryl-Kautschuk)</p>

BMW

Ltr.	Motor	Power	Model	Year	Image 1	Image 2	Image 3	Image 4	Image 5	Image 6	Image 7	Image 8	Image 9	Image 10	Image 11	Image 12
2,0	N45 B20 A	127 kW (173 PS)	320 si (E90)	09/05-08/06												
						<p><b>02-39464-01</b> 11 12 7 557 935</p>	<p><b>08-34056-01</b> 11 11 7 511 529</p>		<p><b>61-38130-00</b> 11 12 7 557 933 87 Ø 1 mm MLS</p>	<p><b>14-32310-02</b> 11 12 7 557 934</p>	<p><b>15-39646-01</b> 11 12 0 033 999</p>	<p><b>12-33457-02</b> 11 34 1 340 849</p>	<p><b>11-39642-01</b> </p> <p>11 61 7 547 845</p>	<p><b>71-34056-00</b> 11 13 7 511 224</p>	<p><b>81-34057-00</b> </p> <p>11 11 7 547 842 65x79 A SL RD PTFE ACM</p>	<p><b>81-20745-00</b> </p> <p>11 14 2 249 533 90x110 AB SL LD PTFE (Polytetrafluorethylen)/ACM (Polyacryl-Kautschuk)</p>
2,0	N46 B20 A	100 kW (136 PS)	318 Ci (E46)	12/00-08/06		<p><b>02-37293-01</b> 11 12 0 308 857</p>	<p><b>08-34056-01</b> 11 11 7 511 529</p>		<p><b>61-36255-00</b> 11 12 7 509 710 0,4 mm MLS</p> <p><b>61-36255-10</b> 11 12 7 509 711 0,7 mm MLS</p>	<p><b>14-32314-01</b> 11 12 7 511 534</p>	<p><b>15-37293-01</b> 11 12 0 032 224</p>	<p><b>12-37281-01</b> 11 34 0 054 492</p>	<p><b>11-37282-01</b> </p> <p>11 61 7 530 703</p>	<p><b>71-34056-00</b> 11 13 7 511 224</p>	<p><b>81-34057-00</b> </p> <p>11 11 7 547 842 65x79 A SL RD PTFE ACM</p>	<p><b>81-20745-00</b> </p> <p>11 14 2 249 533 90x110 AB SL LD PTFE (Polytetrafluorethylen)/ACM (Polyacryl-Kautschuk)</p>
2,0	N46 B20 A	105 kW (143 PS)	318 Ci (E46)	09/01-12/07		<p><b>02-37293-01</b> 11 12 0 308 857</p>	<p><b>08-34056-01</b> 11 11 7 511 529</p>		<p><b>61-36255-00</b> 11 12 7 509 710 0,4 mm MLS  ⇒ 01/07</p> <p><b>61-36255-10</b> 11 12 7 509 711 0,7 mm MLS  ⇒ 01/07</p>	<p><b>14-32314-01</b> 11 12 7 511 534  ⇒ 01/07</p>	<p><b>15-37293-01</b> 11 12 0 032 224</p>	<p><b>12-37281-01</b> 11 34 0 054 492</p>	<p><b>11-37282-01</b> </p> <p>11 61 7 530 703</p>	<p><b>71-34056-00</b> 11 13 7 511 224</p>	<p><b>81-34057-00</b> </p> <p>11 11 7 547 842 65x79 A SL RD PTFE ACM</p>	<p><b>81-20745-00</b> </p> <p>11 14 2 249 533 90x110 AB SL LD PTFE (Polytetrafluorethylen)/ACM (Polyacryl-Kautschuk)</p>

BMW

BMW														
2,0	N46 B20 A	105-110 kW (143-150 PS)	318 Ci (E46) 318 i (E46) 318 ti (E46)	03/01-08/06										
Ltr.														
2,0	N46 B20 A	115 kW (156 PS)	120 i (E87)	03/07-06/11										
2,0	N46 B20 B	95 kW (129 PS)	118 i (E81)	09/06-02/08										

02-37293-01  
11 12 0 308 857

08-34056-01  
11 11 7 511 529

61-36255-00  
11 12 7 509 710  
0,4 mm  
MLS

14-32314-01  
11 12 7 511 534

15-37293-01  
11 12 0 032 224

12-37281-01  
11 34 0 054 492

11-37282-01

71-34056-00  
11 13 7 511 224

81-34057-00

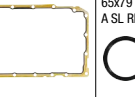
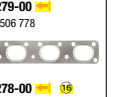
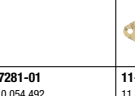
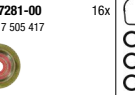
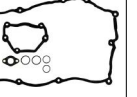
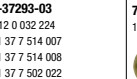
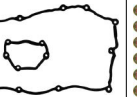
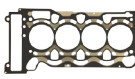
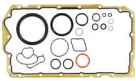
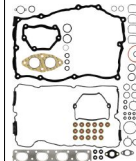

02-37293-01  
11 12 0 308 857

08-34056-01  
11 11 7 511 529

61-37625-00  
11 12 7 563 412  
85 Ø  
0,5 mm  
MLS

14-32310-01  
11 12 7 578 077

15-37293-01  
11 12 0 032 224

12-37281-01  
11 34 0 054 492

11-37282-01

71-34056-00  
11 13 7 511 224

81-34057-00

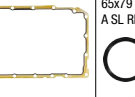
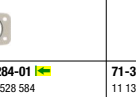
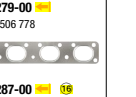
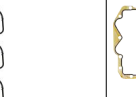
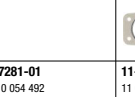
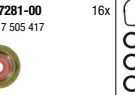
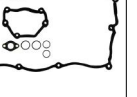
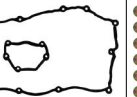
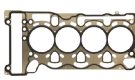
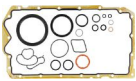
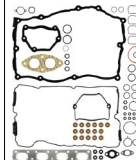

02-37293-02  
11 12 0 391 974  
+11 34 0 029 751

08-34056-01  
11 11 7 511 529

61-37625-00  
11 12 7 563 412  
85 Ø  
0,5 mm  
MLS

14-32310-01  
11 12 7 578 077  
 02/07→

15-39287-01  
11 12 8 655 413

12-37281-01  
11 34 0 054 492

11-37284-01

71-34056-00  
11 13 7 511 224

81-34057-00

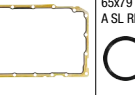
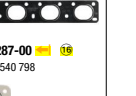
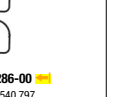
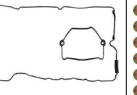
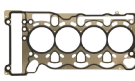
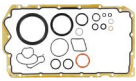
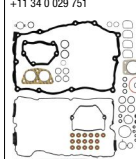

BMW



Ltr.	Motor	Power	Model	Year	Part 1	Part 2	Part 3	Part 4	Part 5	Part 6	Part 7	Part 8	Part 9	Part 10	Part 11
2,0	N46 B20 B	100 kW (136 PS)	118 i (E87)	10/06-06/11		<b>02-37293-02</b> 11 12 0 391 974 +11 34 0 029 751 	<b>08-34056-01</b> 11 11 7 511 529 	<b>61-37625-00</b> 11 12 7 563 412 85 Ø 0,5 mm MLS 02/07→ <b>61-37625-10</b> 11 12 7 578 093 85 Ø 0,8 mm MLS 02/07→ 	<b>14-32310-01</b> 11 12 7 578 077 	<b>15-37293-03</b> 11 12 0 032 224 +11 37 7 514 007 +11 37 7 514 008 +11 37 7 502 022 	<b>12-37281-01</b> 11 34 0 054 492  16x <b>70-37281-00</b> 11 34 7 505 417 	<b>11-37284-01</b> 11 61 7 528 584  <b>71-37286-00</b> 18 30 7 540 797  <b>71-37287-00</b> 18 30 7 540 798 	<b>71-34056-00</b> 11 13 7 511 224 	<b>81-34057-00 K</b> 11 11 7 547 842 65x79 A SL RD PTFE ACM  <b>81-20745-00 K</b> 11 14 2 249 533 90x110 AB SL LD PTFE (Polytetrafluorethylen)/ACM (Polyacryl-Kautschuk) 	
2,0	N46 B20 B	100-115 kW (136-156 PS)	X1 sDrive 18 i (E84) X3 2.0 i (E83) 118 i (E88) 120 i (E82) 120 i (E87) 120 i (E88) 318 i (E90) 318 i (E91) 320 i (E90) 320 i (E92) 320 i (E93) 520 i (E60)	01/07-06/15		<b>02-37293-02</b> 11 12 0 391 974 +11 34 0 029 751 	<b>08-34056-01</b> 11 11 7 511 529 	<b>61-37625-00</b> 11 12 7 563 412 85 Ø 0,5 mm MLS <b>61-37625-10</b> 11 12 7 578 093 85 Ø 0,8 mm MLS 	<b>14-32310-01</b> 11 12 7 578 077 	<b>15-37293-01</b> 11 12 0 032 224  <b>15-37293-03</b> 11 12 0 032 224 +11 37 7 514 007 +11 37 7 514 008 +11 37 7 502 022 	<b>12-37281-01</b> 11 34 0 054 492  16x <b>70-37281-00</b> 11 34 7 505 417 	<b>11-37284-01</b> 11 61 7 528 584  <b>71-37286-00</b> 18 30 7 540 797  <b>71-37287-00</b> 18 30 7 540 798 	<b>71-34056-00</b> 11 13 7 511 224 	<b>81-34057-00 K</b> 11 11 7 547 842 65x79 A SL RD PTFE ACM  <b>81-20745-00 K</b> 11 14 2 249 533 90x110 AB SL LD PTFE (Polytetrafluorethylen)/ACM (Polyacryl-Kautschuk) 	
2,0	N46 B20 B	110 kW (150 PS)	X1 sDrive 18 i (E84)	03/10-06/15		<b>02-37293-02</b> 11 12 0 391 974 +11 34 0 029 751 	<b>08-34056-01</b> 11 11 7 511 529 	<b>61-37625-00</b> 11 12 7 563 412 85 Ø 0,5 mm MLS <b>61-37625-10</b> 11 12 7 578 093 85 Ø 0,8 mm MLS 	<b>14-32310-01</b> 11 12 7 578 077 	<b>12-37281-01</b> 11 34 0 054 492  16x <b>70-37281-00</b> 11 34 7 505 417 	<b>11-37284-01</b> 11 61 7 528 584  <b>71-37286-00</b> 18 30 7 540 797  <b>71-37287-00</b> 18 30 7 540 798 	<b>71-34056-00</b> 11 13 7 511 224 	<b>81-34057-00 K</b> 11 11 7 547 842 65x79 A SL RD PTFE ACM  <b>81-20745-00 K</b> 11 14 2 249 533 90x110 AB SL LD PTFE (Polytetrafluorethylen)/ACM (Polyacryl-Kautschuk) 		

















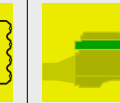
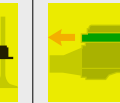
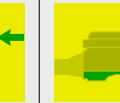
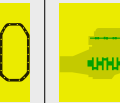
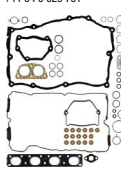







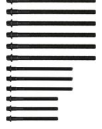





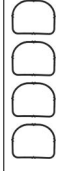

BMW























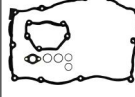
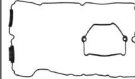

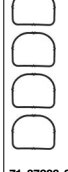

Ltr.															
2,0	N46 B20 B	115 kW (156 PS)	320 i (E91)	09/05-06/12		<b>02-37293-02</b> 11 12 0 391 974 +11 34 0 029 751 									
2,0	N46 B20 BD N46 B20 C N46 B20 CC N46 B20 CD N46 B20 E	110-115 kW (150-156 PS)	120 i (E81, E87) 120 i (E87) 120 i (E88) 320 i (E90)	06/04-12/13		<b>02-37293-02</b> 11 12 0 391 974 +11 34 0 029 751 	<b>08-34056-01</b> 11 11 7 511 529 	<b>61-37625-00</b> 11 12 7 563 412 85 Ø 0,5 mm MLS  <b>61-37625-10</b> 11 12 7 578 093 85 Ø 0,8 mm MLS 	<b>14-32310-01</b> 11 12 7 578 077 	<b>15-39287-01</b> 11 12 8 655 413 	<b>12-37281-01</b> 11 34 0 054 492  16x <b>70-37281-00</b> 11 34 7 505 417  <b>71-37286-00</b> 18 30 7 540 797  <b>71-37287-00</b> 18 30 7 540 798 	<b>71-34056-00</b> 11 13 7 511 224 	<b>81-34057-00 K</b> 11 11 7 547 842 65x79 A SL RD PTFE ACM  <b>81-20745-00 K</b> 11 14 2 249 533 90x110 AB SL LD PTFE (Polytetrafluorethylen)/ACM (Polyacryl-Kautschuk) 		
2,0	N46 B20 C	105-110 kW (143-150 PS)	318 Ci (E46) 318 i (E46)	09/01-08/06		<b>02-37293-02</b> 11 12 0 391 974 +11 34 0 029 751 	<b>08-34056-01</b> 11 11 7 511 529 	<b>61-36255-00</b> 11 12 7 509 710 0,4 mm MLS  <b>61-36255-10</b> 11 12 7 509 711 0,7 mm MLS 	<b>14-32314-01</b> 11 12 7 511 534 	<b>15-39287-01</b> 11 12 8 655 413 	<b>12-37281-01</b> 11 34 0 054 492  16x <b>70-37281-00</b> 11 34 7 505 417  <b>71-37286-00</b> 18 30 7 540 797  <b>71-37287-00</b> 18 30 7 540 798 	<b>71-34056-00</b> 11 13 7 511 224 	<b>81-34057-00 K</b> 11 11 7 547 842 65x79 A SL RD PTFE ACM  <b>81-20745-00 K</b> 11 14 2 249 533 90x110 AB SL LD PTFE (Polytetrafluorethylen)/ACM (Polyacryl-Kautschuk) 		

BMW

Ltr.  2,0 N46 B20 C 110 kW (150 PS) 120 i (E87) 320 i (E90) 06/04-08/07 

										
	<p><b>02-37293-02</b> 11 12 0 391 974 +11 34 0 029 751</p> 	<p><b>08-34056-01</b> 11 11 7 511 529</p> 		<p><b>61-36255-00</b> 11 12 7 509 710 0,4 mm MLS  ⇒ 01/07</p> <p><b>61-36255-10</b> 11 12 7 509 711 0,7 mm MLS  ⇒ 01/07</p>  <p><b>61-37625-00</b> 11 12 7 563 412 85 Ø 0,5 mm MLS  02/07→</p> <p><b>61-37625-10</b> 11 12 7 578 093 85 Ø 0,8 mm MLS  02/07→</p> 	<p><b>14-32314-01</b> 11 12 7 511 534  ⇒ 01/07</p>  <p><b>14-32310-01</b> 11 12 7 578 077  02/07→</p> 	<p><b>15-39287-01</b> 11 12 8 655 413</p> 	<p><b>12-37281-01</b> 11 34 0 054 492</p>  <p><b>70-37281-00</b> 11 34 7 505 417</p> 	<p><b>11-37284-01</b> </p> <p>11 61 7 528 584</p>  <p><b>71-37286-00</b> </p> <p>18 30 7 540 797</p>  <p><b>71-37287-00</b>  </p> <p>18 30 7 540 798</p> 	<p><b>71-34056-00</b> 11 13 7 511 224</p> 	<p><b>81-34057-00</b> </p> <p>11 11 7 547 842 65x79 A SL RD PTFE ACM</p>  <p><b>81-20745-00</b> </p> <p>11 14 2 249 533 90x110 AB SL LD PTFE (Polytetrafluorethylen)/ACM (Polyacryl-Kautschuk)</p> 















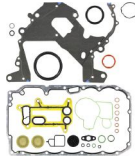



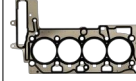

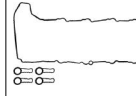





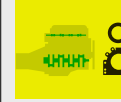



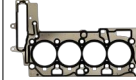

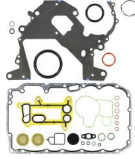







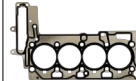
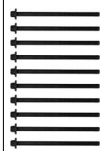

2,0 N46 B20 CB 100-115 kW (136-156 PS)

	<p><b>02-37293-02</b> 11 12 0 391 974 +11 34 0 029 751</p> 	<p><b>08-34056-01</b> 11 11 7 511 529</p> 		<p><b>61-36255-00</b> 11 12 7 509 710 0,4 mm MLS  ⇒ 01/07</p> <p><b>61-36255-10</b> 11 12 7 509 711 0,7 mm MLS  ⇒ 01/07</p>  <p><b>61-37625-00</b> 11 12 7 563 412 85 Ø 0,5 mm MLS  02/07→</p> <p><b>61-37625-10</b> 11 12 7 578 093 85 Ø 0,8 mm MLS  02/07→</p> 	<p><b>14-32314-01</b> 11 12 7 511 534  ⇒ 01/07</p>  <p><b>14-32310-01</b> 11 12 7 578 077  02/07→</p> 	<p><b>15-37293-01</b> 11 12 0 032 224</p>  <p><b>15-37293-03</b> 11 12 0 032 224 +11 37 7 514 007 +11 37 7 514 008 +11 37 7 502 022</p>  <p><b>15-39287-01</b> 11 12 8 655 413</p> 	<p><b>12-37281-01</b> 11 34 0 054 492</p>  <p><b>70-37281-00</b> 11 34 7 505 417</p> 	<p><b>11-37284-01</b> </p> <p>11 61 7 528 584</p>  <p><b>71-37286-00</b> </p> <p>18 30 7 540 797</p>  <p><b>71-37287-00</b>  </p> <p>18 30 7 540 798</p> 	<p><b>71-34056-00</b> 11 13 7 511 224</p> 	<p><b>81-34057-00</b> </p> <p>11 11 7 547 842 65x79 A SL RD PTFE ACM</p>  <p><b>81-20745-00</b> </p> <p>11 14 2 249 533 90x110 AB SL LD PTFE (Polytetrafluorethylen)/ACM (Polyacryl-Kautschuk)</p> 
--	--	--	--	--	--	--	--	---	---	---

BMW

Ltr.	Motor	Power	Model	Year	Image 1	Image 2	Image 3	Image 4	Image 5	Image 6	Image 7	Image 8	Image 9	Image 10	Image 11	Image 12
2,0	N47	100 kW (136 PS)	318 d (E91)	07/07-06/12												
						<p><b>02-39346-01</b> 11 12 7 807 293</p>			<p><b>61-37635-00</b> 11 12 8 506 128 1,55 mm MLS 1</p> <p><b>61-37635-10</b> 11 12 8 506 129 1,6 mm MLS 2</p> <p><b>61-37635-20</b> 11 12 8 506 130 1,65 mm MLS 3</p>			<p><b>15-39346-01</b> 11 12 7 807 017</p>		<p><b>71-39378-00</b>  4x 11 61 7 801 438</p>	<p><b>71-39472-00</b> 11 13 7 807 302  04/10</p> <p><b>70-31414-10</b>  05/10 →</p>	
2,0	N47	100-120 kW (136-163 PS)	X1 sDrive 20 d (E84) 318 d (E90)	09/07-06/15												
						<p><b>02-39346-01</b> 11 12 7 807 293</p>	<p><b>08-39472-01</b> 11 11 7 807 292</p>		<p><b>61-37635-00</b> 11 12 8 506 128 1,55 mm MLS 1</p> <p><b>61-37635-10</b> 11 12 8 506 129 1,6 mm MLS 2</p> <p><b>61-37635-20</b> 11 12 8 506 130 1,65 mm MLS 3</p>			<p><b>15-39346-01</b> 11 12 7 807 017</p>		<p><b>71-39378-00</b>  4x 11 61 7 801 438</p>	<p><b>71-39472-00</b> 11 13 7 807 302  04/10</p> <p><b>70-31414-10</b>  05/10 →</p>	
2,0	N47	125 kW (170 PS)	320 d (E90)	01/07-12/09												
						<p><b>02-39346-01</b> 11 12 7 807 293</p>	<p><b>08-39472-01</b> 11 11 7 807 292</p>		<p><b>61-37635-00</b> 11 12 8 506 128 1,55 mm MLS 1</p> <p><b>61-37635-10</b> 11 12 8 506 129 1,6 mm MLS 2</p> <p><b>61-37635-20</b> 11 12 8 506 130 1,65 mm MLS 3</p>			<p><b>15-39346-01</b> 11 12 7 807 017</p>		<p><b>71-39378-00</b>  4x 11 61 7 801 438</p>	<p><b>71-39472-00</b> 11 13 7 807 302</p>	



BMW

<p>Ltr.  2,0 N47 130 kW (177 PS) X3 2.0 d (E83)  09/08-08/10 </p>		<p><b>02-39346-01</b> 11 12 7 807 293</p> 	<p><b>08-39472-01</b> 11 11 7 807 292</p> 		<p><b>61-37635-00</b> 11 12 8 506 128 1,55 mm MLS </p> <p><b>61-37635-10</b> 11 12 8 506 129 1,6 mm MLS </p> <p><b>61-37635-20</b> 11 12 8 506 130 1,65 mm MLS </p> 		<p><b>15-39346-01</b> 11 12 7 807 017</p> 		<p><b>71-39378-00</b>  4x 11 61 7 801 438</p> 	<p><b>71-39472-00</b> 11 13 7 807 302  ⇒ 04/10</p> 	
<p>2,0 N47 135 kW (184 PS) 320 d (E90) 03/10-10/11</p>					<p><b>61-37635-00</b> 11 12 8 506 128 1,55 mm MLS </p> <p><b>61-37635-10</b> 11 12 8 506 129 1,6 mm MLS </p> <p><b>61-37635-20</b> 11 12 8 506 130 1,65 mm MLS </p> 						
<p>2,0 N47 D20 A N47 D20 C 66 kW (90 PS) 116 d (E81) 01/11-12/11</p>	<p><b>02-39346-01</b> 11 12 7 807 293</p> 	<p><b>08-39472-01</b> 11 11 7 807 292</p> 	<p><b>04-10114-01</b> </p>  <p><b>71-39447-00</b>  11 14 7 797 491</p> 	<p><b>61-37635-00</b> 11 12 8 506 128 1,55 mm MLS </p> <p><b>61-37635-10</b> 11 12 8 506 129 1,6 mm MLS </p> <p><b>61-37635-20</b> 11 12 8 506 130 1,65 mm MLS </p> 	<p><b>14-10398-01</b> 11 12 7 807 294</p> 	<p><b>15-39346-01</b> 11 12 7 807 017</p> 	<p><b>12-39398-01</b> 11 34 7 807 347</p>  <p><b>70-39398-00</b> 16x </p>	<p><b>71-39378-00</b>  4x 11 61 7 801 438</p>  <p><b>71-39421-10</b> 2x 11 62 8 509 783</p> 	<p><b>70-31414-10</b></p> 	<p><b>81-39382-00</b>  11 11 7 802 665 55x68 RD FPM</p>  <p><b>81-39379-00</b>  11 14 7 797 490 90x104 LD FPM</p> 	

BMW

Ltr.	Motor	Power	Model	Year	Image 1	Image 2	Image 3	Image 4	Image 5	Image 6	Image 7	Image 8	Image 9	Image 10	Image 11
2,0	N47 D20 A	85 kW (116 PS)	116 d (E81, E87)	11/08-12/11											
					<b>02-39346-01</b> 11 12 7 807 293	<b>08-39472-01</b> 11 11 7 807 292	<b>04-10114-01</b> 11 12 8 506 128 1,55 mm MLS  <b>61-37635-10</b> 11 12 8 506 129 1,6 mm MLS  <b>61-37635-20</b> 11 12 8 506 130 1,65 mm MLS  <b>71-39447-00</b> 11 14 7 797 491	<b>14-10398-01</b> 11 12 7 807 294	<b>15-39346-01</b> 11 12 7 807 017	<b>12-39398-01</b> 11 34 7 807 347  <b>70-39398-00</b> 16x	<b>71-39378-00</b> 11 61 7 801 438  <b>71-39421-10</b> 11 62 8 509 783  2x	<b>70-31414-10</b> 05/10→  <b>71-39472-00</b> 11 13 7 807 302	<b>81-39382-00</b> 11 11 7 802 665 55x68 RD FPM  <b>81-39379-00</b> 11 14 7 797 490 90x104 LD FPM		
2,0	N47 D20 A	85-130 kW (116-177 PS)	X3 (E83) 116 d (E87) 118 d (E81, E87) 118 d (E88) 120 d (E82) 120 d (E88) 318 d (E90) 520 d (E60)	09/06-12/13											
					<b>02-39346-01</b> 11 12 7 807 293	<b>08-39472-01</b> 11 11 7 807 292	<b>04-10114-01</b> 11 12 8 506 128 1,55 mm MLS  <b>61-37635-10</b> 11 12 8 506 129 1,6 mm MLS  <b>61-37635-20</b> 11 12 8 506 130 1,65 mm MLS  <b>71-39447-00</b> 11 14 7 797 491	<b>14-10398-01</b> 11 12 7 807 294	<b>15-39346-01</b> 11 12 7 807 017	<b>12-39398-01</b> 11 34 7 807 347  <b>70-39398-00</b> 16x	<b>71-39378-00</b> 11 61 7 801 438  <b>71-39421-10</b> 11 62 8 509 783  2x	<b>71-39472-00</b> 11 13 7 807 302	<b>81-39382-00</b> 11 11 7 802 665 55x68 RD FPM  <b>81-39379-00</b> 11 14 7 797 490 90x104 LD FPM		











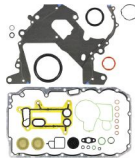







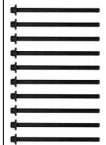
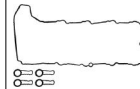
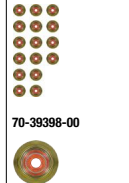









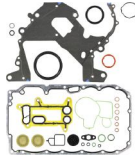

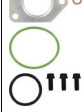



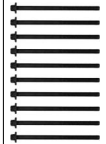
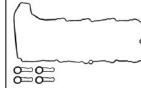
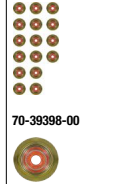

BMW

Ltr.   

2,0 N47 D20 A 100-130 kW (136-177 PS) 118 d (E81, E87) 09/06-12/11  
 118 d (E87)  
 118 d (E87)  
 120 d (E87)

















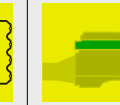
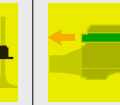
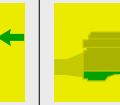

2,0 N47 D20 A 100-145 kW (136-197 PS) 318 d (E91) 07/07-06/12  
 320 d (E93)











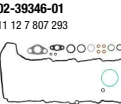

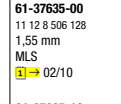
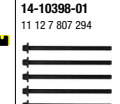
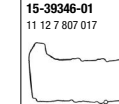
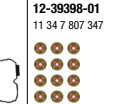
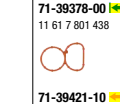
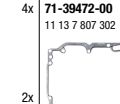
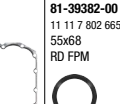
<p><b>02-39346-01</b> 11 12 7 807 293</p> 	<p><b>08-39472-01</b> 11 11 7 807 292</p> 	<p><b>04-10114-01</b> </p>   <p><b>71-39447-00</b>  11 14 7 797 491</p> 	<p><b>61-37630-00</b> 11 12 7 803 099 1,65 mm MLS  ⇒ 05/07</p> <p><b>61-37630-10</b> 11 12 7 803 100 1,7 mm MLS  ⇒ 05/07</p> <p><b>61-37630-20</b> 11 12 7 803 101 1,75 mm MLS  ⇒ 05/07</p>	<p><b>14-10398-01</b> 11 12 7 807 294</p> 	<p><b>15-39346-01</b> 11 12 7 807 017</p> 	<p><b>12-39398-01</b> 11 34 7 807 347</p>  <p><b>70-39398-00</b> 16x</p> 	<p><b>71-39378-00</b>  4x 11 61 7 801 438</p> <p><b>71-39421-10</b> 2x 11 62 8 509 783</p> 	<p><b>71-39472-00</b> 11 13 7 807 302</p> 	<p><b>81-39382-00</b>  11 11 7 802 665 55x68 RD FPM</p>  <p><b>81-39379-00</b>  11 14 7 797 490 90x104 LD FPM</p> 
<p><b>02-39346-01</b> 11 12 7 807 293</p> 	<p><b>08-39472-01</b> 11 11 7 807 292</p> 	<p><b>04-10114-01</b> </p>   <p><b>71-39447-00</b>  11 14 7 797 491</p> 	<p><b>61-37635-00</b> 11 12 8 506 128 1,55 mm MLS  1</p> <p><b>61-37635-10</b> 11 12 8 506 129 1,6 mm MLS  2</p> <p><b>61-37635-20</b> 11 12 8 506 130 1,65 mm MLS  3</p>	<p><b>14-10398-01</b> 11 12 7 807 294</p> 	<p><b>15-39346-01</b> 11 12 7 807 017</p> 	<p><b>12-39398-01</b> 11 34 7 807 347</p>  <p><b>70-39398-00</b> 16x</p> 	<p><b>71-39378-00</b>  4x 11 61 7 801 438</p> <p><b>71-39421-10</b> 2x 11 62 8 509 783</p> <p><b>71-39444-00</b>   16 11 65 7 800 596</p> 	<p><b>71-39472-00</b> 11 13 7 807 302</p> 	<p><b>81-39382-00</b>  11 11 7 802 665 55x68 RD FPM</p>  <p><b>81-39379-00</b>  11 14 7 797 490 90x104 LD FPM</p> 

BMW

Ltr.  2,0 N47 D20 A 105 kW (143 PS) 318 d (E90) 02/07-10/11 

















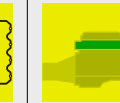
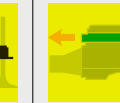
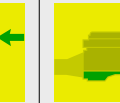
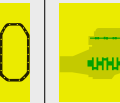





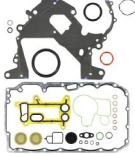

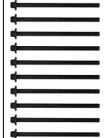

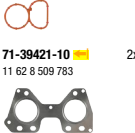
																
02-39346-01 11 12 7 807 293	08-39472-01 11 11 7 807 292	04-10114-01  11 14 7 797 491	61-37635-00 11 12 8 506 128 1,55 mm MLS  ⇒ 02/10	61-37635-10 11 12 8 506 129 1,6 mm MLS  ⇒ 02/10	61-37635-20 11 12 8 506 130 1,65 mm MLS  ⇒ 02/10	71-39447-00  11 14 7 797 491	14-10398-01 11 12 7 807 294	15-39346-01 11 12 7 807 017	12-39398-01 11 34 7 807 347	71-39378-00  11 61 7 801 438	4x	71-39421-10  11 62 8 509 783	2x	71-39472-00 11 13 7 807 302	81-39382-00  11 11 7 802 665 55x68 RD FPM	81-39379-00  11 14 7 797 490 90x104 LD FPM

2,0 N47 D20 A 105 kW (143 PS) 318 d (E91) 09/07-06/12











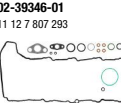

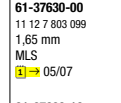
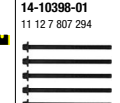
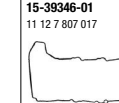
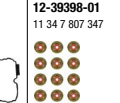
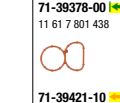
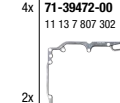
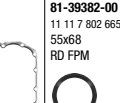





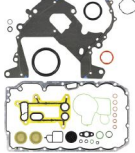

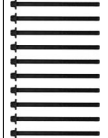



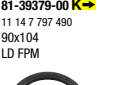

																
02-39346-01 11 12 7 807 293	08-39472-01 11 11 7 807 292	04-10114-01  11 14 7 797 491	61-37635-00 11 12 8 506 128 1,55 mm MLS  ⇒ 02/10	61-37635-10 11 12 8 506 129 1,6 mm MLS  ⇒ 02/10	61-37635-20 11 12 8 506 130 1,65 mm MLS  ⇒ 02/10	71-39447-00  11 14 7 797 491	14-10398-01 11 12 7 807 294	15-39346-01 11 12 7 807 017	12-39398-01 11 34 7 807 347	71-39378-00  11 61 7 801 438	4x	71-39421-10  11 62 8 509 783	2x	71-39472-00 11 13 7 807 302	81-39382-00  11 11 7 802 665 55x68 RD FPM	81-39379-00  11 14 7 797 490 90x104 LD FPM

BMW

Ltr.  N47 D20 A 120 kW (163 PS) 120 d (E87)  1 06/04-06/11

										
02-39346-01 11 12 7 807 293	08-39472-01 11 11 7 807 292	04-10114-01 	61-37630-00 11 12 7 803 099 1,65 mm MLS  ⇒ 05/07	14-10398-01 11 12 7 807 294	15-39346-01 11 12 7 807 017	12-39398-01 11 34 7 807 347	71-39378-00  4x 11 61 7 801 438	71-39421-10  2x 11 14 7 809 783	71-39472-00 11 13 7 807 302	81-39382-00  11 11 7 802 665 55x68 RD FPM
			61-37630-10 11 12 7 803 100 1,7 mm MLS  ⇒ 05/07							
		71-39447-00  11 14 7 797 491	61-37630-20 11 12 7 803 101 1,75 mm MLS  ⇒ 05/07			70-39398-00 16x 	71-39444-00   11 65 7 800 596			81-39379-00  11 14 7 797 490 90x104 LD FPM

2,0 N47 D20 A 120-145 kW (163-197 PS) 120 d (E87) 320 d (E90) 320 d (E92) 12/04-06/13



















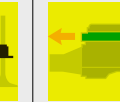
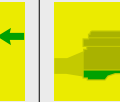
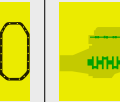

										
02-39346-01 11 12 7 807 293	08-39472-01 11 11 7 807 292	04-10114-01 	61-37630-00 11 12 7 803 099 1,65 mm MLS  ⇒ 05/07	14-10398-01 11 12 7 807 294	15-39346-01 11 12 7 807 017	12-39398-01 11 34 7 807 347	71-39378-00  4x 11 61 7 801 438	71-39421-10  2x 11 62 8 509 783	71-39472-00 11 13 7 807 302	81-39382-00  11 11 7 802 665 55x68 RD FPM
			61-37630-10 11 12 7 803 100 1,7 mm MLS  ⇒ 05/07							
		71-39447-00  11 14 7 797 491	61-37630-20 11 12 7 803 101 1,75 mm MLS  ⇒ 05/07			70-39398-00 16x 	71-39444-00   11 65 7 800 596			81-39379-00  11 14 7 797 490 90x104 LD FPM
			61-37635-00 11 12 8 506 128 1,55 mm MLS  05/07→							
			61-37635-10 11 12 8 506 129 1,6 mm MLS  05/07→							
			61-37635-20 11 12 8 506 130 1,65 mm MLS  05/07→							











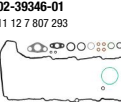

BMW

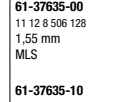
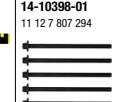
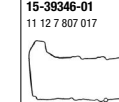
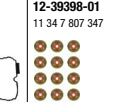
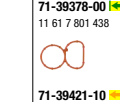
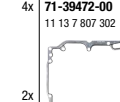
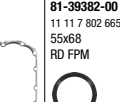
Ltr.    

2,0 N47 D20 A 130 kW (177 PS) 120 d (E81, E87) 09/06-12/11 320 d (E92)

													
<b>02-39346-01</b> 11 12 7 807 293	<b>08-39472-01</b> 11 11 7 807 292	<b>04-10114-01</b>  08/08	<b>61-37630-00</b> 11 12 7 803 099 1,65 mm MLS  05/07	<b>61-37630-10</b> 11 12 7 803 100 1,7 mm MLS  05/07	<b>61-37630-20</b> 11 12 7 803 101 1,75 mm MLS  05/07	<b>14-10398-01</b> 11 12 7 807 294	<b>15-39346-01</b> 11 12 7 807 017	<b>12-39398-01</b> 11 34 7 807 347	<b>71-39378-00</b>  11 61 7 801 438	<b>71-39421-10</b>  11 62 8 509 783	<b>71-39472-00</b> 11 13 7 807 302	<b>81-39382-00</b>  11 11 7 802 665 55x68 RD FPM	<b>81-39379-00</b>  11 14 7 797 490 90x104 LD FPM
			<b>61-37635-00</b> 11 12 8 506 128 1,55 mm MLS  05/07→	<b>61-37635-10</b> 11 12 8 506 129 1,6 mm MLS  05/07→	<b>61-37635-20</b> 11 12 8 506 130 1,65 mm MLS  05/07→			<b>70-39398-00</b> 16x					













































2,0 N47 D20 A 130-145 kW (177-197 PS) 120 d (E82) 02/07-12/13 120 d (E88) 320 d (E90) 320 d (E91) 320 d (E93) 520 d (E61)

													
<b>02-39346-01</b> 11 12 7 807 293	<b>08-39472-01</b> 11 11 7 807 292	<b>04-10114-01</b>  08/08	<b>61-37635-00</b> 11 12 8 506 128 1,55 mm MLS  05/07→	<b>61-37635-10</b> 11 12 8 506 129 1,6 mm MLS  05/07→	<b>61-37635-20</b> 11 12 8 506 130 1,65 mm MLS  05/07→	<b>14-10398-01</b> 11 12 7 807 294	<b>15-39346-01</b> 11 12 7 807 017	<b>12-39398-01</b> 11 34 7 807 347	<b>71-39378-00</b>  11 61 7 801 438	<b>71-39421-10</b>  11 62 8 509 783	<b>71-39472-00</b> 11 13 7 807 302	<b>81-39382-00</b>  11 11 7 802 665 55x68 RD FPM	<b>81-39379-00</b>  11 14 7 797 490 90x104 LD FPM
								<b>70-39398-00</b> 16x					



BMW













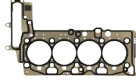
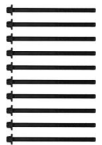
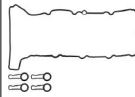

Ltr.															
2,0	N47 D20 B N47 D20 D	150 kW (204 PS)	123 d (E81, E87) 123 d (E82) 123 d (E87) 123 d (E88)	03/07-12/13											
					<b>02-39346-02</b> 11 12 7 811 594 	<b>08-39472-01</b> 11 11 7 807 292 	<b>71-39447-00</b> 11 14 7 797 491 	<b>61-37635-00</b> 11 12 8 506 128 1,55 mm MLS 	<b>14-10398-01</b> 11 12 7 807 294 	<b>15-39346-01</b> 11 12 7 807 017 	<b>12-39398-01</b> 11 34 7 807 347 	<b>71-39378-00</b> 11 61 7 801 438 	<b>71-39421-10</b> 11 62 8 509 783 	<b>71-39472-00</b> 11 13 7 807 302 	<b>81-39382-00</b> 11 11 7 802 665 55x68 RD FPM 
								<b>61-37635-10</b> 11 12 8 506 129 1,6 mm MLS 			<b>70-39398-00</b> 16x 	<b>70-31414-10</b>  05/10-→ 	<b>81-39379-00</b> 11 14 7 797 490 90x104 LD FPM 		
								<b>61-37635-20</b> 11 12 8 506 130 1,65 mm MLS 							
2,0	N47 D20 C	66-130 kW (90-177 PS)	X1 sDrive 18 d (E84) X1 sDrive 20 d (E84) X1 xDrive 20 d (E84) 116 d (E87)	03/09-06/15											
					<b>02-39346-01</b> 11 12 7 807 293 	<b>08-39472-01</b> 11 11 7 807 292 	<b>71-39447-00</b> 11 14 7 797 491 	<b>61-37635-00</b> 11 12 8 506 128 1,55 mm MLS 	<b>14-10398-01</b> 11 12 7 807 294 	<b>15-39346-01</b> 11 12 7 807 017 	<b>12-39398-01</b> 11 34 7 807 347 	<b>71-39378-00</b> 11 61 7 801 438 	<b>71-39421-10</b> 11 62 8 509 783 	<b>70-31414-10</b>  05/10-→ 	<b>81-39382-00</b> 11 11 7 802 665 55x68 RD FPM 
								<b>61-37635-10</b> 11 12 8 506 129 1,6 mm MLS 			<b>70-39398-00</b> 16x 				
								<b>61-37635-20</b> 11 12 8 506 130 1,65 mm MLS 							
2,0	N47 D20 C	85 kW (116 PS)	X1 sDrive 16 d (E84)	04/12-06/15											
					<b>02-38110-01</b> 11 12 7 807 293 	<b>08-39472-01</b> 11 11 7 807 292 	<b>71-39447-00</b> 11 14 7 797 491 	<b>61-38110-00</b> 11 12 8 509 146 84,7 Ø 1,45 mm MLS 	<b>14-10398-01</b> 11 12 7 807 294 	<b>15-41286-01</b> 11 12 8 511 814 	<b>12-39398-01</b> 11 34 7 807 347 	<b>71-10389-00</b> 11 61 8 506 407 	<b>71-39421-10</b> 11 62 8 509 783 	<b>70-31414-10</b>  05/10-→ 	<b>81-39382-00</b> 11 11 7 802 665 55x68 RD FPM 
					<b>02-39346-01</b> 11 12 7 807 293 			<b>61-38110-10</b> 11 12 8 509 147 84,7 Ø 1,55 mm MLS 			<b>70-39398-00</b> 16x 				
								<b>61-38110-20</b> 11 12 8 509 148 84,7 Ø 1,65 mm MLS 							

BMW













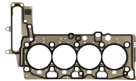
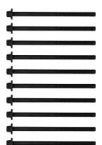
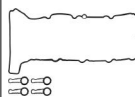

Ltr.														
2,0	N47 D20 C	85-145 kW (116-197 PS)	X3 1.8 d (E83) X3 2.0 d (E83) 116 d (E81, E87) 118 d (E81, E87) 118 d (E82) 118 d (E87) 118 d (E88) 118 d (E88) 120 d (E81, E87) 120 d (E82) 120 d (E87) 120 d (E88) 316 d (E90) 320 d (E90) 520 d (E61)	09/06-12/13										
2,0	N47 D20 C	85-147 kW (116-200 PS)	116 d (F20) 116 d (F21) 118 d (F20) 118 d (F21) 118 d xDrive (F20) 316 d (E91) 318 d (F30) 318 d (F34) 320 d (E93) 520 d (F07) 520 d (F10, F18) 520 d (F11)	09/09										
2,0	N47 D20 C	100 kW (136 PS)	118 d (E81, E87)	09/06-12/11										

BMW

Ltr.  N47 D20 C 100 kW (136 PS) 520 d (F07)  07/13-02/17

















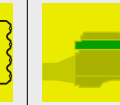
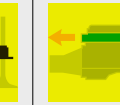
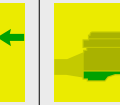

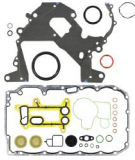





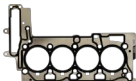

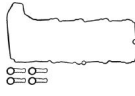

				<p><b>61-38110-00</b> 11 12 8 509 146 84,7 Ø 1,45 mm MLS</p> <p><b>61-38110-10</b> 11 12 8 509 147 84,7 Ø 1,55 mm MLS</p> <p><b>61-38110-20</b> 11 12 8 509 148 84,7 Ø 1,65 mm MLS</p> 	<p><b>14-10398-01</b> 11 12 7 807 294</p> 	<p><b>15-41286-01</b> 11 12 8 511 814</p> 	<p><b>12-39398-01</b> 11 34 7 807 347</p> <p><b>70-39398-00</b> 16x</p> 	<p><b>71-10389-00</b> </p> <p>11 61 8 506 407</p>  <p><b>71-39421-10</b> 2x</p> <p>11 62 8 509 783</p> 	<p><b>70-31414-10</b></p> 	<p><b>81-39382-00</b> </p> <p>11 11 7 802 665 55x68 RD FPM</p>  <p><b>81-39379-00</b> </p> <p>11 14 7 797 490 90x104 LD FPM</p> 
--	--	---	--	--	---	---	---	--	---	--

2,0 N47 D20 C 100 kW (136 PS) 520 d xDrive (F11) 07/13-06/14















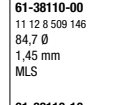
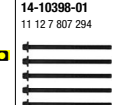

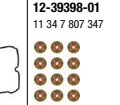
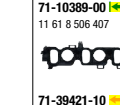





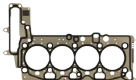

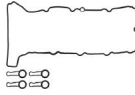

			<p><b>71-39447-00</b> </p> <p>11 14 7 797 491</p> 	<p><b>61-38110-00</b> 11 12 8 509 146 84,7 Ø 1,45 mm MLS</p> <p><b>61-38110-10</b> 11 12 8 509 147 84,7 Ø 1,55 mm MLS</p> <p><b>61-38110-20</b> 11 12 8 509 148 84,7 Ø 1,65 mm MLS</p> 	<p><b>14-10398-01</b> 11 12 7 807 294</p> 	<p><b>15-41286-01</b> 11 12 8 511 814</p> 	<p><b>12-39398-01</b> 11 34 7 807 347</p> <p><b>70-39398-00</b> 16x</p> 	<p><b>71-10389-00</b> </p> <p>11 61 8 506 407</p>  <p><b>71-39421-10</b> 2x</p> <p>11 62 8 509 783</p>  <p><b>71-39444-00</b>  </p> <p>11 65 7 800 596</p> 	<p><b>70-31414-10</b></p> 	<p><b>81-39382-00</b> </p> <p>11 11 7 802 665 55x68 RD FPM</p>  <p><b>81-39379-00</b> </p> <p>11 14 7 797 490 90x104 LD FPM</p> 
--	--	--	--	--	---	---	---	---	---	--

BMW

Ltr.  2,0 N47 D20 C 100-105 kW (136-143 PS) X1 sDrive 18 d (E84) X1 xDrive 18 d (E84) 03/09-06/15  1













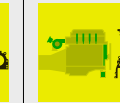
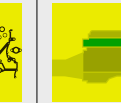
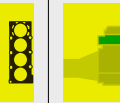
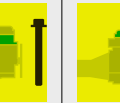
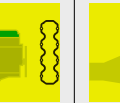
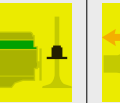
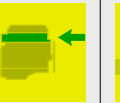





										
	<p><b>02-39346-01</b> 11 12 7 807 293</p> 	<p><b>08-39472-01</b> 11 11 7 807 292</p> 	<p><b>71-39447-00</b> </p> <p>11 14 7 797 491</p> 	<p><b>61-37635-00</b> 11 12 8 506 128 1,55 mm MLS </p> <p><b>61-37635-10</b> 11 12 8 506 129 1,6 mm MLS </p> <p><b>61-37635-20</b> 11 12 8 506 130 1,65 mm MLS </p> 	<p><b>14-10398-01</b> 11 12 7 807 294</p> 	<p><b>15-39346-01</b> 11 12 7 807 017</p> 	<p><b>12-39398-01</b> 11 34 7 807 347</p>  <p><b>70-39398-00</b> 16x </p>	<p><b>71-39378-00</b>  4x 11 61 7 801 438</p>  <p><b>71-39421-10</b>  2x 11 62 8 509 783</p> 	<p><b>70-31414-10</b></p> 	<p><b>81-39382-00</b> </p> <p>11 11 7 802 665 55x68 RD FPM</p>  <p><b>81-39379-00</b> </p> <p>11 14 7 797 490 90x104 LD FPM</p> 

2,0 N47 D20 C 100-120 kW (136-163 PS) 318 d (F31) 320 d xDrive (F31) 11/12-06/19











										
	<p><b>02-38110-01</b></p> 			<p><b>61-38110-00</b> 11 12 8 509 146 84,7 Ø 1,45 mm MLS </p> <p><b>61-38110-10</b> 11 12 8 509 147 84,7 Ø 1,55 mm MLS </p> <p><b>61-38110-20</b> 11 12 8 509 148 84,7 Ø 1,65 mm MLS </p> 	<p><b>14-10398-01</b> 11 12 7 807 294</p> 	<p><b>15-41286-01</b> 11 12 8 511 814</p> 	<p><b>12-39398-01</b> 11 34 7 807 347</p>  <p><b>70-39398-00</b> 16x </p>	<p><b>71-10389-00</b>   11 61 8 506 407</p>  <p><b>71-39421-10</b>  2x 11 62 8 509 783</p> 	<p><b>70-31414-10</b></p> 	<p><b>81-39382-00</b> </p> <p>11 11 7 802 665 55x68 RD FPM</p>  <p><b>81-39379-00</b> </p> <p>11 14 7 797 490 90x104 LD FPM</p> 

BMW

Ltr.  2,0 N47 D20 C 100-125 kW (136-170 PS) 318 d (E90) 318 d (E91) 320 d (E90) 01/07-06/12 

											
02-38110-01 11 12 7 807 293	02-39346-01 11 12 7 807 293	08-39472-01 11 11 7 807 292	04-10282-01  71-39447-00  11 14 7 797 491	61-37635-00 11 12 8 506 128 1,55 mm MLS  61-37635-10 11 12 8 506 129 1,6 mm MLS  61-37635-20 11 12 8 506 130 1,65 mm MLS  61-38110-00 11 12 8 509 146 84,7 Ø 1,45 mm MLS  61-38110-10 11 12 8 509 147 84,7 Ø 1,55 mm MLS  61-38110-20 11 12 8 509 148 84,7 Ø 1,65 mm MLS 	14-10398-01 11 12 7 807 294	15-39346-01 11 12 7 807 017	12-39398-01 11 34 7 807 347	71-10389-00  11 61 8 506 407 71-39378-00  11 61 7 801 438 71-39421-10  11 62 8 509 783 71-39444-00  11 65 7 800 596	70-31414-10 71-39472-00 11 13 7 807 302	81-39382-00  11 11 7 802 665 55x68 RD FPM 81-39379-00  11 14 7 797 490 90x104 LD FPM	



2,0 N47 D20 C 100-147 kW (136-200 PS) X3 (F25) X3 1.8 d (F25) 120 d (F21) 220 d (F22, F87) 320 d (F30) 320 d (F34) 320 d xDrive (F30, F80) 320 d xDrive (F34) 420 d Coupe (F32, F82) 420 d (F32) 420 d (F32, F82) 420 d (F33, F83) 420 d (F36) 420 d Gran Coupe (F36) 420 d xDrive Coupe (F32, F82) 420 d xDrive (F36) 420 d xDrive Gran Coupe (F36) 518 d (F10) 518 d (F11) 520 d (F10) 520 d (F11)













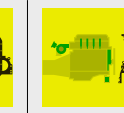

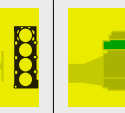
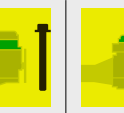
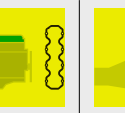
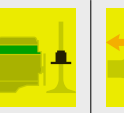

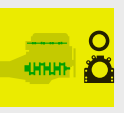
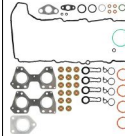

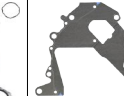



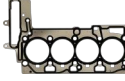

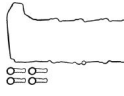



02-38110-01	02-39346-01	04-10282-01  71-39447-00  11 14 7 797 491	61-38110-00 11 12 8 509 146 84,7 Ø 1,45 mm MLS  61-38110-10 11 12 8 509 147 84,7 Ø 1,55 mm MLS  61-38110-20 11 12 8 509 148 84,7 Ø 1,65 mm MLS 	14-10398-01 11 12 7 807 294	15-41286-01 11 12 8 511 814	12-39398-01 11 34 7 807 347	71-10389-00  11 61 8 506 407 71-39421-10  11 62 8 509 783 71-39444-00  11 65 7 800 596	70-31414-10	81-39382-00  11 11 7 802 665 55x68 RD FPM 81-39379-00  11 14 7 797 490 90x104 LD FPM
-------------	-------------	---	--	--------------------------------	--------------------------------	--------------------------------	--	-------------	---

BMW













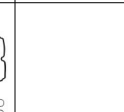
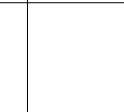
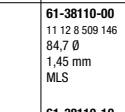
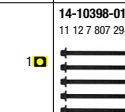
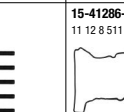
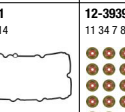
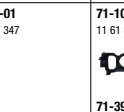
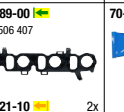

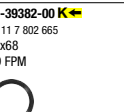

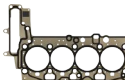







Ltr.	Motor	Power	Model	Year	Image 1	Image 2	Image 3	Image 4	Image 5	Image 6	Image 7	Image 8	Image 9	Image 10	Image 11
2,0	N47 D20 C	100-147 kW (136-200 PS)	X3 xDrive 20 d (F25) 120 d (F20) 120 d (F21) 218 d (F22, F87) 318 d (F34) 320 d (F34) 320 d xDrive (F34) 418 d (F36) 420 d (F33, F83) 420 d (F36) 420 d xDrive (F32, F82) 420 d xDrive (F36) 520 d (F10) 520 d (F11) 520 d xDrive (F10) 520 d xDrive (F10) 520 d xDrive (F11)	06/10											
					<b>02-38110-01</b> 11 12 7 807 293	<b>71-39447-00</b> 11 14 7 797 491	<b>61-38110-00</b> 11 12 8 509 146 84,7 Ø 1,45 mm MLS  <b>61-38110-10</b> 11 12 8 509 147 84,7 Ø 1,55 mm MLS  <b>61-38110-20</b> 11 12 8 509 148 84,7 Ø 1,65 mm MLS 	<b>14-10398-01</b> 11 12 7 807 294	<b>15-41286-01</b> 11 12 8 511 814	<b>12-39398-01</b> 11 34 7 807 347	<b>71-10389-00</b> 11 61 8 506 407  <b>71-39421-10</b> 11 62 8 509 783 2x  <b>71-39444-00</b> 11 65 7 800 596	<b>70-31414-10</b> 	<b>81-39382-00</b> 11 11 7 802 665 55x68 RD FPM  <b>81-39379-00</b> 11 14 7 797 490 90x104 LD FPM 		
2,0	N47 D20 C	105 kW (143 PS)	X3 1.8 d (E83)	09/08-12/11											
					<b>02-39346-01</b> 11 12 7 807 293	<b>08-39472-01</b> 11 11 7 807 292	<b>71-39447-00</b> 11 14 7 797 491	<b>61-37635-00</b> 11 12 8 506 128 1,55 mm MLS  <b>61-37635-10</b> 11 12 8 506 129 1,6 mm MLS  <b>61-37635-20</b> 11 12 8 506 130 1,65 mm MLS 	<b>14-10398-01</b> 11 12 7 807 294	<b>15-39346-01</b> 11 12 7 807 017	<b>12-39398-01</b> 11 34 7 807 347	<b>71-39378-00</b> 11 61 7 801 438 4x  <b>71-39421-10</b> 11 62 8 509 783 2x  <b>70-39398-00</b> 16x 	<b>71-39472-00</b> 11 13 7 807 302  <b>81-39382-00</b> 11 11 7 802 665 55x68 RD FPM  <b>81-39379-00</b> 11 14 7 797 490 90x104 LD FPM 		

BMW

Ltr.  2,0 N47 D20 C 105 kW (143 PS) 318 d (E90) 318 d (E91) 02/07-06/12 

											
	<p><b>02-39346-01</b> 11 12 7 807 293</p> 	<p><b>08-39472-01</b> 11 11 7 807 292</p> 	<p><b>71-39447-00</b> </p> <p>11 14 7 797 491</p> 	<p><b>61-37635-00</b> 11 12 8 506 128 1,55 mm MLS  ⇒ 02/10</p> <p><b>61-37635-10</b> 11 12 8 506 129 1,6 mm MLS  ⇒ 02/10</p> <p><b>61-37635-20</b> 11 12 8 506 130 1,65 mm MLS  ⇒ 02/10</p> 	<p><b>14-10398-01</b> 11 12 7 807 294</p> 	<p><b>15-39346-01</b> 11 12 7 807 017</p> 	<p><b>12-39398-01</b> 11 34 7 807 347</p>  <p><b>70-39398-00</b> 16x</p> 	<p><b>71-39378-00</b>  4x 11 61 7 801 438</p>  <p><b>71-39421-10</b>  2x 11 62 8 509 783</p> 	<p><b>71-39472-00</b> 11 13 7 807 302</p> 	<p><b>81-39382-00</b>  </p> <p>11 11 7 802 665 55x68 RD FPM</p>  <p><b>81-39379-00</b>  </p> <p>11 14 7 797 490 90x104 LD FPM</p> 	



















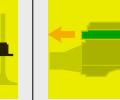



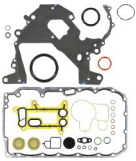









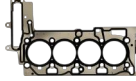
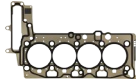

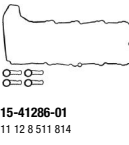
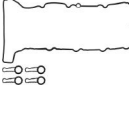







2,0 N47 D20 C 105 kW (143 PS) 318 d (F31) 318 d (F31) 11/12-06/15

											
	<p><b>02-38110-01</b></p> 			<p><b>61-38110-00</b> 11 12 8 509 146 84,7 Ø 1,45 mm MLS</p> <p><b>61-38110-10</b> 11 12 8 509 147 84,7 Ø 1,55 mm MLS</p> <p><b>61-38110-20</b> 11 12 8 509 148 84,7 Ø 1,65 mm MLS</p> 	<p><b>14-10398-01</b> 11 12 7 807 294</p> 	<p><b>15-41286-01</b> 11 12 8 511 814</p> 	<p><b>12-39398-01</b> 11 34 7 807 347</p>  <p><b>70-39398-00</b> 16x</p> 	<p><b>71-10389-00</b>  11 61 8 506 407</p>  <p><b>71-39421-10</b>  2x 11 62 8 509 783</p>  <p><b>71-39444-00</b>   11 65 7 800 596</p> 	<p><b>70-31414-10</b></p> 	<p><b>81-39382-00</b>  </p> <p>11 11 7 802 665 55x68 RD FPM</p>  <p><b>81-39379-00</b>  </p> <p>11 14 7 797 490 90x104 LD FPM</p> 	

















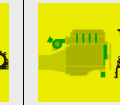

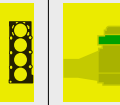
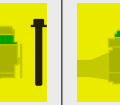
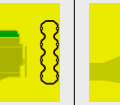
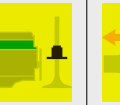
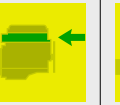

BMW

Ltr.  2,0 N47 D20 C 120 kW (163 PS) X1 sDrive 20 d (E84)  03/10-06/15







										
	<p><b>02-38110-01</b> 11 12 7 807 293</p>  <p><b>02-39346-01</b> 11 12 7 807 293</p> 	<p><b>08-39472-01</b> 11 11 7 807 292</p> 	<p><b>04-10282-01</b> </p>  <p><b>71-39447-00</b>  11 14 7 797 491</p> 	<p><b>61-37635-00</b> 11 12 8 506 128 1,55 mm MLS </p> <p><b>61-37635-10</b> 11 12 8 506 129 1,6 mm MLS </p> <p><b>61-37635-20</b> 11 12 8 506 130 1,65 mm MLS </p> <p><b>61-38110-00</b> 11 12 8 509 146 84,7 Ø 1,45 mm MLS </p> <p><b>61-38110-10</b> 11 12 8 509 147 84,7 Ø 1,55 mm MLS </p> <p><b>61-38110-20</b> 11 12 8 509 148 84,7 Ø 1,65 mm MLS </p>  	<p><b>14-10398-01</b> 11 12 7 807 294</p> 	<p><b>15-39346-01</b> 11 12 7 807 017</p>  <p><b>15-41286-01</b> 11 12 8 511 814</p> 	<p><b>12-39398-01</b> 11 34 7 807 347</p>  <p><b>70-39398-00</b> 16x </p>	<p><b>71-10389-00</b>  11 61 8 506 407</p>  <p><b>71-39378-00</b>  4x 11 61 7 801 438</p>  <p><b>71-39421-10</b>  2x 11 62 8 509 783</p>  <p><b>71-39444-00</b>   11 65 7 800 596</p> 	<p><b>70-31414-10</b></p>  <p><b>71-39472-00</b> 11 13 7 807 302</p> 	<p><b>81-39382-00</b>  11 11 7 802 665 55x68 RD FPM</p>  <p><b>81-39379-00</b>  11 14 7 797 490 90x104 LD FPM</p> 

BMW

Ltr.  2,0 N47 D20 C 120 kW (163 PS) 320 d (E90) 12/04-10/11 













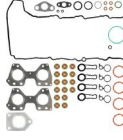

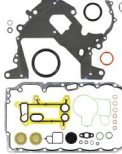
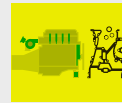



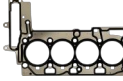
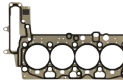



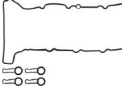







											
02-39346-01 11 12 7 807 293 1 → 08/08	08-39472-01 11 11 7 807 292 1 → 08/08	04-10282-01  11 12 8 506 128 1,55 mm MLS 1 → 08/08	61-37635-00 11 12 8 506 129 1,6 mm MLS 1 → 08/08	61-37635-10 11 12 8 506 129 1,6 mm MLS 1 → 08/08	61-37635-20 11 12 8 506 130 1,65 mm MLS 1 → 08/08	14-10398-01 11 12 7 807 294	15-39346-01 11 12 7 807 017 1 → 08/08	12-39398-01 11 34 7 807 347	71-39378-00  11 61 7 801 438 1 → 08/08	71-39472-00 11 13 7 807 302 1 → 04/10	81-39382-00  11 11 7 802 665 55x68 RD FPM
02-38110-01 1 → 09/08 →		71-39447-00  11 14 7 797 491	61-38110-00 11 12 8 509 146 84,7 Ø 1,45 mm MLS 1 → 09/08 →	61-38110-10 11 12 8 509 147 84,7 Ø 1,55 mm MLS 1 → 09/08 →	61-38110-20 11 12 8 509 148 84,7 Ø 1,65 mm MLS 1 → 09/08 →		15-41286-01 11 12 8 511 814 1 → 09/08 →	70-39398-00 16x	71-10389-00  11 61 8 506 407 1 → 09/08 →	70-31414-10 1 → 05/10 →	81-39379-00  11 14 7 797 490 90x104 LD FPM
									71-39421-10  11 62 8 509 783	71-39421-10  11 62 8 509 783	
									71-39444-00  11 65 7 800 596		

2,0 N47 D20 C 120 kW (163 PS) 320 d (E91) 07/09-06/12



















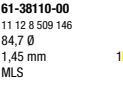
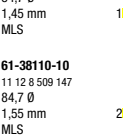
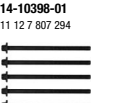

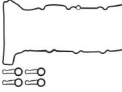

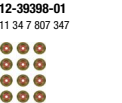

02-39346-01 11 12 7 807 293	08-39472-01 11 11 7 807 292	04-10282-01  11 12 8 506 128 1,55 mm MLS 1 → 08/08	61-37635-00 11 12 8 506 129 1,6 mm MLS 1 → 08/08	61-37635-10 11 12 8 506 129 1,6 mm MLS 1 → 08/08	61-37635-20 11 12 8 506 130 1,65 mm MLS 1 → 08/08	14-10398-01 11 12 7 807 294	15-39346-01 11 12 7 807 017	12-39398-01 11 34 7 807 347	71-39378-00  11 61 7 801 438	71-39472-00 11 13 7 807 302	81-39382-00  11 11 7 802 665 55x68 RD FPM
		71-39447-00  11 14 7 797 491							71-39421-10  11 62 8 509 783		81-39379-00  11 14 7 797 490 90x104 LD FPM

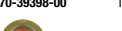
BMW

Ltr.  2,0 N47 D20 C 120 kW (163 PS) 320 d (E93) 01/08-12/13













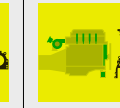

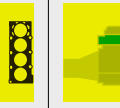
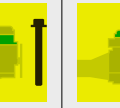
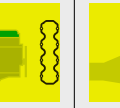
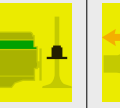



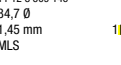

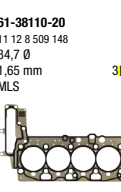

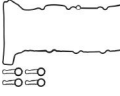

	 <p><b>02-39346-01</b> 11 12 7 807 293 1 → 01/10</p>  <p><b>02-38110-01</b> 1 → 02/10 →</p> 	 <p><b>08-39472-01</b> 11 11 7 807 292 1 → 01/10</p> 	 <p><b>71-39447-00</b>  11 14 7 797 491</p> 	 <p><b>61-37635-00</b> 11 12 8 506 128 1,55 mm MLS 1 → 01/10</p> <p><b>61-37635-10</b> 11 12 8 506 129 1,6 mm MLS 2 → 01/10</p> <p><b>61-37635-20</b> 11 12 8 506 130 1,65 mm MLS 3 → 01/10</p>  <p><b>61-38110-00</b> 11 12 8 509 146 84,7 Ø 1,45 mm MLS 1 → 02/10 →</p> <p><b>61-38110-10</b> 11 12 8 509 147 84,7 Ø 1,55 mm MLS 2 → 02/10 →</p> <p><b>61-38110-20</b> 11 12 8 509 148 84,7 Ø 1,65 mm MLS 3 → 02/10 →</p> 	 <p><b>14-10398-01</b> 11 12 7 807 294</p> 	 <p><b>15-39346-01</b> 11 12 7 807 017 1 → 01/10</p>  <p><b>15-41286-01</b> 11 12 8 511 814 1 → 02/10 →</p> 	 <p><b>12-39398-01</b> 11 34 7 807 347</p>  <p><b>70-39398-00</b> 16x</p> 	 <p><b>71-39378-00</b>  4x 11 61 7 801 438 1 → 01/10</p>  <p><b>71-10389-00</b>  11 61 8 506 407 1 → 02/10 →</p> <p><b>71-39421-10</b>  2x 11 62 8 509 783</p> 	 <p><b>71-39472-00</b> 11 13 7 807 302 1 → 04/10</p>  <p><b>70-31414-10</b> 1 → 05/10 →</p> 	 <p><b>81-39382-00</b>  11 11 7 802 665 55x68 RD FPM</p>  <p><b>81-39379-00</b>  11 14 7 797 490 90x104 LD FPM</p> 
--	--	--	--	--	--	--	--	--	--	---

2,0 N47 D20 C 120 kW (163 PS) 320 d xDrive (F30, F80) 08/12-10/18











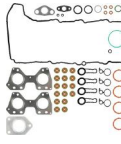





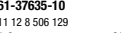
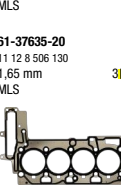

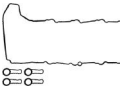

 <p><b>02-38110-01</b></p> 	 <p><b>02-38110-01</b></p> 	 <p><b>71-39447-00</b>  11 14 7 797 491</p> 	 <p><b>61-38110-00</b> 11 12 8 509 146 84,7 Ø 1,45 mm MLS 1 →</p> <p><b>61-38110-10</b> 11 12 8 509 147 84,7 Ø 1,55 mm MLS 2 →</p> <p><b>61-38110-20</b> 11 12 8 509 148 84,7 Ø 1,65 mm MLS 3 →</p> 	 <p><b>14-10398-01</b> 11 12 7 807 294</p> 	 <p><b>15-41286-01</b> 11 12 8 511 814</p> 	 <p><b>12-39398-01</b> 11 34 7 807 347</p>  <p><b>70-39398-00</b> 16x</p> 	 <p><b>71-39421-10</b>  2x 11 62 8 509 783</p>  <p><b>71-39444-00</b>   11 65 7 800 596</p> 	 <p><b>70-31414-10</b></p> 	 <p><b>81-39382-00</b>  11 11 7 802 665 55x68 RD FPM</p>  <p><b>81-39379-00</b>  11 14 7 797 490 90x104 LD FPM</p> 
---	---	---	--	---	---	---	--	---	--

BMW











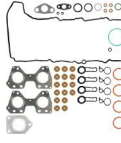



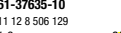
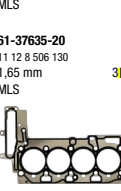

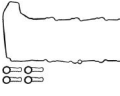

Ltr.  2,0 N47 D20 C 120 kW (163 PS) 520 d xDrive (E92) 09/08-06/13 

											
	<b>02-38110-01</b> 11 12 8 509 146 84,7 Ø 1,45 mm MLS 			<b>61-38110-00</b> 11 12 8 509 146 84,7 Ø 1,45 mm MLS  <b>61-38110-10</b> 11 12 8 509 147 84,7 Ø 1,55 mm MLS  <b>61-38110-20</b> 11 12 8 509 148 84,7 Ø 1,65 mm MLS 	<b>14-10398-01</b> 11 12 7 807 294 	<b>15-41286-01</b> 11 12 8 511 814 	<b>12-39398-01</b> 11 34 7 807 347  <b>70-39398-00</b> 16x 	<b>71-41322-00</b>  11 61 7 812 938  <b>71-39421-10</b>  11 62 8 509 783 	<b>70-31414-10</b> 11 61 7 812 938 	<b>81-39382-00</b>  11 11 7 802 665 55x68 RD FPM  <b>81-39379-00</b>  11 14 7 797 490 90x104 LD FPM 	



2,0 N47 D20 C 130 kW (177 PS) X3 2.0 d (E83) 09/08-08/10















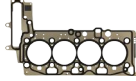
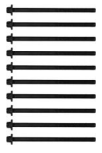
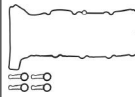



	<b>02-39346-01</b> 11 12 7 807 293 	<b>08-39472-01</b> 11 11 7 807 292 	<b>04-10282-01</b>  11 12 8 506 128 1,55 mm MLS  <b>71-39447-00</b>  11 14 7 797 491 	<b>61-37635-00</b> 11 12 8 506 128 1,55 mm MLS  <b>61-37635-10</b> 11 12 8 506 129 1,6 mm MLS  <b>61-37635-20</b> 11 12 8 506 130 1,65 mm MLS 	<b>14-10398-01</b> 11 12 7 807 294 	<b>15-39346-01</b> 11 12 7 807 017 	<b>12-39398-01</b> 11 34 7 807 347  <b>70-39398-00</b> 16x 	<b>71-39378-00</b>  11 61 7 801 438  <b>71-39421-10</b>  11 62 8 509 783 	<b>71-39472-00</b> 11 13 7 807 302 	<b>81-39382-00</b>  11 11 7 802 665 55x68 RD FPM  <b>81-39379-00</b>  11 14 7 797 490 90x104 LD FPM 
--	--	---	--	---	--	--	---	--	--	---

2,0 N47 D20 C 130-147 kW (177-200 PS) 320 d (E90) 02/07-05/12  
320 d (E91)  
320 d (E92)  
320 d (E93)  
320 d xDrive (E91)  
320 d xDrive (E92)  
520 d (E60)













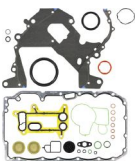



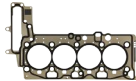
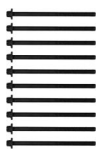
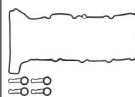



	<b>02-39346-01</b> 11 12 7 807 293 	<b>08-39472-01</b> 11 11 7 807 292 	<b>71-39447-00</b>  11 14 7 797 491 	<b>61-37635-00</b> 11 12 8 506 128 1,55 mm MLS  <b>61-37635-10</b> 11 12 8 506 129 1,6 mm MLS  <b>61-37635-20</b> 11 12 8 506 130 1,65 mm MLS 	<b>14-10398-01</b> 11 12 7 807 294 	<b>15-39346-01</b> 11 12 7 807 017 	<b>12-39398-01</b> 11 34 7 807 347  <b>70-39398-00</b> 16x 	<b>71-39378-00</b>  11 61 7 801 438  <b>71-39421-10</b>  11 62 8 509 783 	<b>71-39472-00</b> 11 13 7 807 302 	<b>81-39382-00</b>  11 11 7 802 665 55x68 RD FPM  <b>81-39379-00</b>  11 14 7 797 490 90x104 LD FPM 
--	--	---	--	---	--	--	---	--	--	---

BMW



Ltr.  N47 D20 C 134 kW (182 PS) X3 sDrive 28 d (F25) 04/14-12/16 













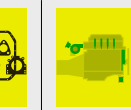

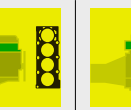









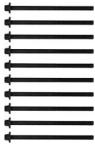
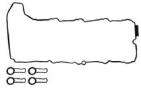









				<p><b>61-38110-00</b> 11 12 8 509 146 84,7 Ø 1,45 mm MLS</p> <p><b>61-38110-10</b> 11 12 8 509 147 84,7 Ø 1,55 mm MLS</p> <p><b>61-38110-20</b> 11 12 8 509 148 84,7 Ø 1,65 mm MLS</p> 	<p><b>14-10398-01</b> 11 12 7 807 294</p> 	<p><b>15-41286-01</b> 11 12 8 511 814</p> 	<p><b>12-39398-01</b> 11 34 7 807 347</p> 	<p><b>71-10389-00</b> </p> <p>11 61 8 506 407</p>  <p><b>71-39421-10</b>  2x</p> <p>11 62 8 509 783</p>  <p><b>71-39444-00</b>  </p> <p>11 65 7 800 596</p> 	<p><b>70-31414-10</b></p> 	<p><b>81-39382-00</b> </p> <p>11 11 7 802 665 55x68 RD FPM</p>  <p><b>81-39379-00</b> </p> <p>11 14 7 797 490 90x104 LD FPM</p> 
--	--	---	--	--	---	---	---	---	---	--

2,0 N47 D20 C 135 kW (184 PS) X1 sDrive 20 d (E84) X1 xDrive 20 d (E84) 07/12-06/15















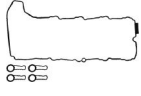



	<p><b>02-38110-01</b> 11 12 7 807 293</p>  <p><b>02-39346-01</b> 11 12 7 807 293</p> 	<p><b>08-39472-01</b> 11 11 7 807 292</p> 	<p><b>04-10282-01</b> </p>  <p><b>71-39447-00</b> </p> <p>11 14 7 797 491</p> 	<p><b>61-38110-00</b> 11 12 8 509 146 84,7 Ø 1,45 mm MLS</p> <p><b>61-38110-10</b> 11 12 8 509 147 84,7 Ø 1,55 mm MLS</p> <p><b>61-38110-20</b> 11 12 8 509 148 84,7 Ø 1,65 mm MLS</p> 	<p><b>14-10398-01</b> 11 12 7 807 294</p> 	<p><b>15-41286-01</b> 11 12 8 511 814</p> 	<p><b>12-39398-01</b> 11 34 7 807 347</p> 	<p><b>71-10389-00</b> </p> <p>11 61 8 506 407</p>  <p><b>71-39421-10</b>  2x</p> <p>11 62 8 509 783</p>  <p><b>71-39444-00</b>  </p> <p>11 65 7 800 596</p> 	<p><b>70-31414-10</b></p> 	<p><b>81-39382-00</b> </p> <p>11 11 7 802 665 55x68 RD FPM</p>  <p><b>81-39379-00</b> </p> <p>11 14 7 797 490 90x104 LD FPM</p> 
---	---	--	--	--	---	---	---	---	---	--

BMW

Ltr.  N47 D20 C 135 kW (184 PS) 320 d (E90)  03/10-10/11

											
02-39346-01 11 12 7 807 293	08-39472-01 11 11 7 807 292	04-10282-01 	61-37635-00 11 12 8 506 128 1,55 mm MLS 	61-37635-10 11 12 8 506 129 1,6 mm MLS 	61-37635-20 11 12 8 506 130 1,65 mm MLS 	14-10398-01 11 12 7 807 294 	15-39346-01 11 12 7 807 017 	12-39398-01 11 34 7 807 347 	71-39378-00  11 61 7 801 438  71-39421-10  11 62 8 509 783 	4x 71-39472-00 11 13 7 807 302   ⇒ 04/10	81-39382-00  11 11 7 802 665 55x68 RD FPM 
		71-39447-00  11 14 7 797 491 	61-38110-00 11 12 8 509 146 84,7 Ø 1,45 mm MLS 	61-38110-10 11 12 8 509 147 84,7 Ø 1,55 mm MLS 	61-38110-20 11 12 8 509 148 84,7 Ø 1,65 mm MLS 			70-39398-00 16x 		70-31414-10  05/10 → 	81-39379-00  11 14 7 797 490 90x104 LD FPM 

2,0 N47 D20 C 135 kW (184 PS) 320 d (E91) 03/10-06/12

















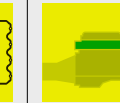
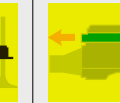
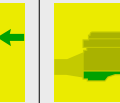
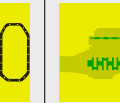





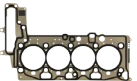

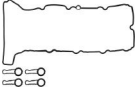

02-39346-01 11 12 7 807 293	08-39472-01 11 11 7 807 292	04-10282-01 	61-38110-00 11 12 8 509 146 84,7 Ø 1,45 mm MLS 	61-38110-10 11 12 8 509 147 84,7 Ø 1,55 mm MLS 	61-38110-20 11 12 8 509 148 84,7 Ø 1,65 mm MLS 	14-10398-01 11 12 7 807 294 	15-39346-01 11 12 7 807 017 	12-39398-01 11 34 7 807 347 	71-39378-00  11 61 7 801 438  71-39421-10  11 62 8 509 783 	4x 71-39472-00 11 13 7 807 302 	81-39382-00  11 11 7 802 665 55x68 RD FPM 
		71-39447-00  11 14 7 797 491 						70-39398-00 16x 			81-39379-00  11 14 7 797 490 90x104 LD FPM 

BMW























Ltr.	Motor	Power	Model	Year	Image 1	Image 2	Image 3	Image 4	Image 5	Image 6	Image 7	Image 8	Image 9	Image 10	Image 11	Image 12
2,0	N47 D20 C	135 kW (184 PS)	320 d (F31)	07/12-02/16												
						<p><b>02-38110-01</b></p>		<p><b>04-10282-01</b> </p>	<p><b>61-38110-00</b> 11 12 8 509 146 84,7 Ø 1,45 mm MLS </p> <p><b>61-38110-10</b> 11 12 8 509 147 84,7 Ø 1,55 mm MLS </p> <p><b>61-38110-20</b> 11 12 8 509 148 84,7 Ø 1,65 mm MLS </p>	<p><b>14-10398-01</b> 11 12 7 807 294</p>	<p><b>15-41286-01</b> 11 12 8 511 814</p>	<p><b>12-39398-01</b> 11 34 7 807 347</p> <p><b>70-39398-00</b> 16x</p>	<p><b>71-10389-00</b> </p> <p><b>71-39421-10</b>  2x</p> <p><b>71-39444-00</b> </p>	<p><b>70-31414-10</b></p>	<p><b>81-39382-00</b> </p> <p><b>81-39379-00</b> </p>	
2,0	N47 D20 C	135-147 kW (184-200 PS)	120 d (F20) 120 d (F21) 120 d xDrive (F20) 120 d xDrive (F21) 320 d (E92) 320 d (E93) 320 d (F30, F80) 320 d xDrive (F30, F35, F80) 520 d (F07)	03/10												
						<p><b>02-38110-01</b></p>		<p><b>04-10282-01</b> </p> <p><b>71-39447-00</b> </p>	<p><b>61-38110-00</b> 11 12 8 509 146 84,7 Ø 1,45 mm MLS </p> <p><b>61-38110-10</b> 11 12 8 509 147 84,7 Ø 1,55 mm MLS </p> <p><b>61-38110-20</b> 11 12 8 509 148 84,7 Ø 1,65 mm MLS </p>	<p><b>14-10398-01</b> 11 12 7 807 294</p>	<p><b>15-41286-01</b> 11 12 8 511 814</p>	<p><b>12-39398-01</b> 11 34 7 807 347</p> <p><b>70-39398-00</b> 16x</p>	<p><b>71-10389-00</b> </p> <p><b>71-39421-10</b>  2x</p> <p><b>71-39444-00</b> </p>	<p><b>70-31414-10</b></p>	<p><b>81-39382-00</b> </p> <p><b>81-39379-00</b> </p>	
2,0	N47 D20 C	145-147 kW (197-200 PS)	320 d (E92) 320 d (E93) 320 d xDrive (E92)	09/07-06/13												
						<p><b>02-39346-01</b> 11 12 7 807 293</p>	<p><b>08-39472-01</b> 11 11 7 807 292</p>	<p><b>71-39447-00</b> </p>	<p><b>61-37635-00</b> 11 12 8 506 128 1,55 mm MLS </p> <p><b>61-37635-10</b> 11 12 8 506 129 1,6 mm MLS </p> <p><b>61-37635-20</b> 11 12 8 506 130 1,65 mm MLS </p>	<p><b>14-10398-01</b> 11 12 7 807 294</p>	<p><b>15-39346-01</b> 11 12 7 807 017</p>	<p><b>12-39398-01</b> 11 34 7 807 347</p> <p><b>70-39398-00</b> 16x</p>	<p><b>71-39378-00</b> </p> <p><b>71-39421-10</b>  2x</p> <p><b>71-39444-00</b> </p>	<p><b>70-31414-10</b></p>	<p><b>81-39382-00</b> </p> <p><b>81-39379-00</b> </p>	

BMW



















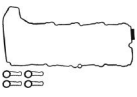

Ltr.  N47 D20 C 147 kW (200 PS) 320 d (F31) 320 d xDrive (F31) 07/12-02/16 

										
	<b>02-38110-01</b> 		<b>04-10282-01</b>  	<b>61-38110-00</b> 11 12 8 509 146 84,7 Ø 1,45 mm MLS  <b>61-38110-10</b> 11 12 8 509 147 84,7 Ø 1,55 mm MLS  <b>61-38110-20</b> 11 12 8 509 148 84,7 Ø 1,65 mm MLS  	<b>14-10398-01</b> 11 12 7 807 294 	<b>15-41286-01</b> 11 12 8 511 814 	<b>12-39398-01</b> 11 34 7 807 347  <b>70-39398-00</b> 16x 	<b>71-10389-00</b>  11 61 8 506 407  <b>71-39421-10</b>  2x 11 62 8 509 783 	<b>70-31414-10</b>  	<b>81-39382-00</b>  11 11 7 802 665 55x68 RD FPM  <b>81-39379-00</b>  11 14 7 797 490 90x104 LD FPM 

2,0 N47 D20 D 150 kW (204 PS) X1 xDrive 23 d (E84) 10/09-06/15

	<b>02-39346-02</b> 11 12 7 811 594 	<b>08-39472-01</b> 11 11 7 807 292 		<b>61-37635-00</b> 11 12 8 506 128 1,55 mm MLS  <b>61-37635-10</b> 11 12 8 506 129 1,6 mm MLS  <b>61-37635-20</b> 11 12 8 506 130 1,65 mm MLS  	<b>14-10398-01</b> 11 12 7 807 294 	<b>15-39346-01</b> 11 12 7 807 017 	<b>12-39398-01</b> 11 34 7 807 347  <b>70-39398-00</b> 16x 	<b>71-39378-00</b>  11 61 7 801 438  <b>71-39421-10</b>  2x 11 62 8 509 783 	<b>71-39472-00</b> 11 13 7 807 302  11/11  <b>70-31414-10</b>  12/11→ 	<b>81-39382-00</b>  11 11 7 802 665 55x68 RD FPM  <b>81-39379-00</b>  11 14 7 797 490 90x104 LD FPM 
--	--	---	--	---	--	--	---	---	--	---

2,0 N47 D20 D 150 kW (204 PS) 123 d (E81, E87) 03/07-12/11

























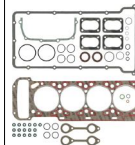
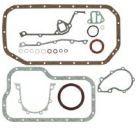
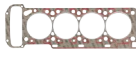
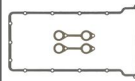
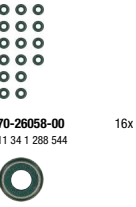

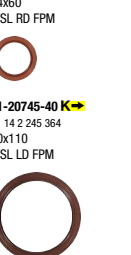
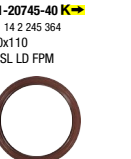

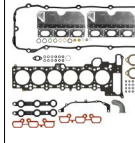
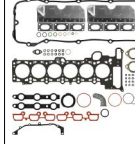

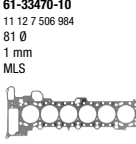

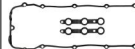
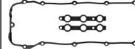
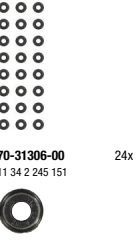

	<b>02-39346-02</b> 11 12 7 811 594 	<b>08-39472-01</b> 11 11 7 807 292 	<b>71-39447-00</b>  11 14 7 797 491 	<b>61-37635-00</b> 11 12 8 506 128 1,55 mm MLS  <b>61-37635-10</b> 11 12 8 506 129 1,6 mm MLS  <b>61-37635-20</b> 11 12 8 506 130 1,65 mm MLS  	<b>14-10398-01</b> 11 12 7 807 294 	<b>15-39346-01</b> 11 12 7 807 017 	<b>12-39398-01</b> 11 34 7 807 347  <b>70-39398-00</b> 16x 	<b>71-39378-00</b>  11 61 7 801 438  <b>71-39421-10</b>  2x 11 62 8 509 783 	<b>71-39472-00</b> 11 13 7 807 302  04/10 	<b>81-39382-00</b>  11 11 7 802 665 55x68 RD FPM  <b>81-39379-00</b>  11 14 7 797 490 90x104 LD FPM 
--	---	--	---	---	---	---	--	--	--	--

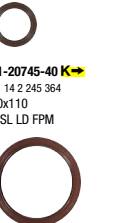

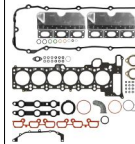
BMW

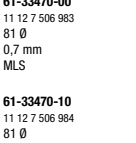
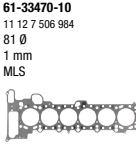
Ltr.	Motor	Power (kW)	Model	Year	Image 1	Image 2	Image 3	Image 4	Image 5	Image 6	Image 7	Image 8	Image 9	Image 10	Image 11	Image 12
2,0	N47 D20 D	155-160 kW (211-218 PS)	X1 xDrive 25 d (E84) X5 sDrive 25 d (F15, F85) X5 xDrive 25 d (F15, F85) X5 2.5 d (F15) 125 d (F20) 125 d (F21) 225 d (F22, F87) 325 d (F30) 325 d (F30, F35, F80) 325 d (F31) 325 d (F34) 425 d (F32, F82) 425 d (F33, F83) 525 d (F10) 525 d (F11) 525 d xDrive (F11)	10/09												
									<p><b>61-38110-00</b> 11 12 8 509 146 84,7 Ø 1,45 mm MLS</p> <p><b>61-38110-10</b> 11 12 8 509 147 84,7 Ø 1,55 mm MLS</p> <p><b>61-38110-20</b> 11 12 8 509 148 84,7 Ø 1,65 mm MLS</p>	<p><b>14-10398-01</b> 11 12 7 807 294</p>	<p><b>15-41286-01</b> 11 12 8 511 814</p>	<p><b>12-39398-01</b> 11 34 7 807 347</p> <p><b>70-39398-00</b> 16x</p>	<p><b>71-41322-00</b> </p> <p>11 61 7 812 938</p> <p><b>71-39421-10</b> 2x</p> <p>11 62 8 509 783</p>	<p><b>70-31414-10</b></p>	<p><b>81-39382-00</b> </p> <p>11 11 7 802 665 55x68 RD FPM</p> <p><b>81-39379-00</b> </p> <p>11 14 7 797 490 90x104 LD FPM</p>	
2,0	N47N	100-125 kW (136-170 PS)	X1 sDrive 20 d (E84) 318 d (E90) 318 d (E91) 320 d (E90)	01/07-06/15		<p><b>02-38110-01</b></p>		<p><b>61-38110-00</b> 11 12 8 509 146 84,7 Ø 1,45 mm MLS</p> <p><b>61-38110-10</b> 11 12 8 509 147 84,7 Ø 1,55 mm MLS</p> <p><b>61-38110-20</b> 11 12 8 509 148 84,7 Ø 1,65 mm MLS</p>		<p><b>15-41286-01</b> 11 12 8 511 814</p>		<p><b>71-10389-00</b> </p> <p>11 61 8 506 407</p>	<p><b>70-31414-10</b></p>			
2,0	N47N	100-135 kW (136-184 PS)	X1 sDrive 18 d (E84) X1 xDrive 18 d (E84) 320 d (E90)	03/09-06/15				<p><b>61-38110-00</b> 11 12 8 509 146 84,7 Ø 1,45 mm MLS</p> <p><b>61-38110-10</b> 11 12 8 509 147 84,7 Ø 1,55 mm MLS</p> <p><b>61-38110-20</b> 11 12 8 509 148 84,7 Ø 1,65 mm MLS</p>								

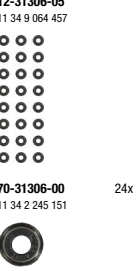
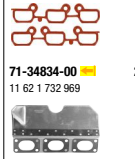
BMW

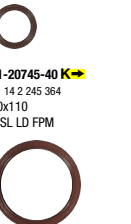
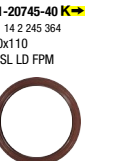
Ltr.														
2,0	S14 B20 (204EA) S14 204 EA	141 kW (192 PS)	320 is (E30) 05/88	 <b>02-35080-01</b> 11 12 1 316 992	 <b>08-19737-05</b> 11 11 1 316 993	 <b>61-35080-00</b> 11 12 1 316 714 94,5 Ø 1,82 mm		 <b>15-35167-01</b> 11 12 1 312 171 +11 12 1 312 173 (2x)	 <b>12-26058-03</b> 11 34 9 059 171 (2x)  <b>70-26058-00</b> 11 34 1 288 544	 <b>71-27182-10</b> 11 62 1 312 961	4x	 <b>71-19737-20</b> 11 13 1 727 974	 <b>81-28498-00</b> K↔ 11 14 1 435 848 44x60 A SL RD FPM   <b>81-20745-40</b> K↔ 11 14 2 245 364 90x110 A SL LD FPM	
2,2	M54 B22 (226S1)	120-125 kW (163-170 PS)	Z3 2.2 i (E36) 320 Ci (E46) 320 i (E46) 520 i (E39) 01/00-12/07	 <b>02-33077-01</b> 11 12 7 507 597 1 → 09/02   <b>02-33470-02</b> 11 12 7 507 597 +11 12 7 506 983 +11 62 1 732 969 1 → 09/02   <b>02-33470-03</b> 11 12 0 141 055 +11 12 7 506 983 +11 62 1 732 969 (2x) 1 10/02 →	 <b>08-27698-05</b> 11 11 1 432 478	 <b>61-33470-00</b> 11 12 7 506 983 81 Ø 0,7 mm MLS   <b>61-33470-10</b> 11 12 7 506 984 81 Ø 1 mm MLS	 <b>14-32101-01</b> 11 12 1 740 065	 <b>15-33077-01</b> 11 12 9 070 990 1 → 09/02   <b>15-33077-02</b> 11 12 0 030 496 1 10/02 →	 <b>12-31306-05</b> 11 34 9 064 457  <b>70-31306-00</b> 11 34 2 245 151	24x	 <b>11-33074-01</b> K↔ 11 61 1 436 631   <b>71-34834-00</b> K↔ 11 62 1 732 969	2x	 <b>71-27698-10</b> 11 13 1 437 237	 <b>81-17404-50</b> K↔ 11 14 1 265 431 48x65 AB SL RD FPM   <b>81-20745-40</b> K↔ 11 14 2 245 364 90x110 A SL LD FPM
2,2	M54 B22 (226S1)	120-125 kW (163-170 PS)	Z4 2.2 i (E85) 320 Ci (E46) 520 i (E60) 07/03-03/10	 <b>02-33470-03</b> 11 12 0 141 055 +11 12 7 506 983 +11 62 1 732 969 (2x)	 <b>08-27698-05</b> 11 11 1 432 478	 <b>61-33470-00</b> 11 12 7 506 983 81 Ø 0,7 mm MLS   <b>61-33470-10</b> 11 12 7 506 984 81 Ø 1 mm MLS	 <b>14-32101-01</b> 11 12 1 740 065	 <b>15-33077-02</b> 11 12 0 030 496	 <b>12-31306-05</b> 11 34 9 064 457  <b>70-31306-00</b> 11 34 2 245 151	24x	 <b>11-33074-01</b> K↔ 11 61 1 436 631   <b>71-34834-00</b> K↔ 11 62 1 732 969	2x	 <b>71-27698-10</b> 11 13 1 437 237	 <b>81-17404-50</b> K↔ 11 14 1 265 431 48x65 AB SL RD FPM   <b>81-20745-40</b> K↔ 11 14 2 245 364 90x110 A SL LD FPM

BMW

Ltr.															
2,2	M54 B22 (226S1)	125 kW (170 PS)	Z3 2.2 i (E36)	10/00-06/02		<p><b>02-33077-01</b> 11 12 7 507 597</p> <p><b>02-33470-02</b> 11 12 7 507 597 +11 12 7 506 983 +11 62 1 732 969</p>	<p><b>08-27698-05</b> 11 11 1 432 478</p>		<p><b>61-33470-00</b> 11 12 7 506 983 81 Ø 0,7 mm MLS</p> <p><b>61-33470-10</b> 11 12 7 506 984 81 Ø 1 mm MLS</p>	<p><b>14-32101-01</b> 11 12 1 740 065</p>	<p><b>15-33077-01</b> 11 12 9 070 990</p>	<p><b>12-31306-05</b> 11 34 9 064 457</p> <p><b>70-31306-00</b> 11 34 2 245 151</p>	<p><b>11-33074-01</b> </p> <p>11 61 1 436 631</p> <p><b>71-34834-00</b> </p> <p>11 62 1 732 969</p>	<p><b>71-27698-10</b> 11 13 1 437 237</p>	<p><b>81-17404-50</b> </p> <p>11 14 1 265 431 48x65 AB SL RD FPM</p> <p><b>81-20745-40</b> </p> <p>11 14 2 245 364 90x110 A SL LD FPM</p>
2,3	M20 B23 (236EA) M20 B23 (236EB) M20 B23 (236EC) M20 B23 (236EW)	102-110 kW (139-150 PS)	323 i (E21) 323 i (E30)	01/78		<p><b>02-24465-06</b> 11 12 1 730 876</p>	<p><b>08-24600-03</b> 11 11 1 730 875</p>		<p><b>61-24465-50</b> 11 12 1 722 726 81 Ø 2,05 mm</p> <p><b>61-24465-60</b> 11 12 1 722 725 81 Ø 1,75 mm</p>	<p><b>14-32001-01</b> 11 12 1 726 478</p>	<p><b>71-24469-10</b> 11 12 1 730 229</p>	<p><b>12-26058-01</b> 11 34 9 059 172</p> <p><b>70-26058-00</b> 11 34 1 288 544</p>	<p><b>71-27037-10</b> </p> <p>11 61 1 726 010</p> <p><b>71-27038-10</b> </p> <p>11 61 1 726 012</p> <p><b>71-27122-10</b> </p> <p>11 62 1 728 489</p> <p><b>71-25844-20</b> </p> <p>18 11 1 728 364</p> <p><b>71-27467-00</b> </p> <p>11 76 1 711 717</p>	<p><b>71-24600-20</b> 11 13 1 730 234</p>	<p><b>81-17404-50</b> </p> <p>11 14 1 265 431 48x65 AB SL RD FPM</p> <p><b>81-20745-40</b> </p> <p>11 14 2 245 364 90x110 A SL LD FPM</p> <p><b>81-24641-10</b> </p> <p>11 12 1 285 609 38x50 A SL FPM</p>
2,3	S14 B23 (EVO I) S14 B23 (234EA) S14 B23 (234S1) S14 B23 (234S2)	143-162 kW (195-220 PS)	M3 EVO I (E30) M3 (E30) M3 2.3 (E30)	01/86		<p><b>02-35080-01</b> 11 12 1 316 992</p>	<p><b>08-19737-05</b> 11 11 1 316 993</p>		<p><b>61-35080-00</b> 11 12 1 316 714 94,5 Ø 1,82 mm</p>	<p><b>15-35167-01</b> 11 12 1 312 171 +11 12 1 312 173 (2x)</p>	<p><b>12-26058-03</b> 11 34 9 059 171 (2x)</p> <p><b>70-26058-00</b> 11 34 1 288 544</p>	<p><b>71-27182-10</b> </p> <p>11 62 1 312 961</p>	<p><b>71-19737-20</b> 11 13 1 727 974</p>	<p><b>81-28498-00</b> </p> <p>11 14 1 435 848 44x60 A SL RD FPM</p> <p><b>81-20745-40</b> </p> <p>11 14 2 245 364 90x110 A SL LD FPM</p>	

BMW

Ltr.	Motor	Power (kW/PS)	Engine Code	Year Range	Image 1	Image 2	Image 3	Image 4	Image 5	Image 6	Image 7	Image 8	Image 9	Image 10	Image 11	Image 12
2,4	M21 D24 (246DA)	63 kW (86 PS)	324 d (E30) 524 d (E28)	09/85-12/90												
						<b>02-26059-04</b> 11 12 2 243 877 	<b>08-24600-04</b> 11 11 2 243 888 		<b>61-26205-30</b> 11 12 2 244 727 81 Ø 1,55 mm 	<b>14-32003-01</b> 11 12 2 243 143(14x) 	<b>71-26059-00</b> 11 12 1 285 973 	<b>12-26058-01</b> 11 34 9 059 172 	<b>71-27308-10</b> 11 61 2 243 867 	<b>71-27039-10</b> 11 62 2 243 884 	<b>71-24600-20</b> 11 13 1 730 234 	<b>81-17404-50 K</b> 11 14 1 265 431 48x65 AB SL RD FPM 
								<b>61-26205-40</b> 11 12 2 244 728 81 Ø 1,68 mm 				<b>70-26058-00</b> 11 34 1 288 544 	<b>71-27467-00</b> <b>08</b> 2x 11 76 1 711 717 			<b>81-20745-40 K</b> 11 14 2 245 364 90x110 A SL LD FPM 
								<b>61-26205-50</b> 11 12 2 244 729 81 Ø 1,87 mm 								<b>81-24641-10 N</b> 11 12 1 285 609 38x50 A SL FPM 
2,4	M21 D24 (246TA) M21 D24 (246TB)	85 kW (115 PS)	324 td (E30) 524 td (E28) 524 td (E34)	09/83-06/93												
						<b>02-26059-03</b> 11 12 2 243 879 	<b>08-24600-04</b> 11 11 2 243 888 		<b>61-26205-30</b> 11 12 2 244 727 81 Ø 1,55 mm 	<b>14-32003-01</b> 11 12 2 243 143(14x) 	<b>71-26059-00</b> 11 12 1 285 973 	<b>12-26058-01</b> 11 34 9 059 172 	<b>71-27308-10</b> 11 61 2 243 867 	<b>71-29396-00</b> 11 62 2 243 782 	<b>71-24600-20</b> 11 13 1 730 234 	<b>81-17404-50 K</b> 11 14 1 265 431 48x65 AB SL RD FPM 
								<b>61-26205-40</b> 11 12 2 244 728 81 Ø 1,68 mm 				<b>70-26058-00</b> 11 34 1 288 544 				<b>81-20745-40 K</b> 11 14 2 245 364 90x110 A SL LD FPM 
								<b>61-26205-50</b> 11 12 2 244 729 81 Ø 1,87 mm 								<b>81-24641-10 N</b> 11 12 1 285 609 38x50 A SL FPM 

BMW

Ltr.    1

2,4-2,5 M21 D24 W 63 kW (86 PS)

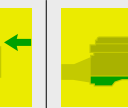
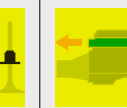
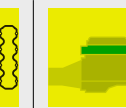
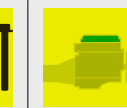

**02-26059-04**  
11 12 2 243 877

**08-24600-04**  
11 11 2 243 888

**61-26205-30**  
11 12 2 244 727  
81 Ø  
1,55 mm

**61-26205-40**  
11 12 2 244 728  
81 Ø  
1,68 mm

**61-26205-50**  
11 12 2 244 729  
81 Ø  
1,87 mm

**14-32003-01**  
11 12 2 243 143(14x)

**71-26059-00**  
11 12 1 285 973

**12-26058-01**  
11 34 9 059 172

**70-26058-00**  
11 34 1 288 544

**71-27308-10**  3x  
11 61 2 243 867

**71-27039-10**  
11 62 2 243 884

**71-27467-00**   2x  
11 76 1 711 717

**71-24600-20**  
11 13 1 730 234

**81-17404-50**    
11 14 1 265 431  
48x65  
AB SL RD FPM

**81-20745-40**    
11 14 2 245 364  
90x110  
A SL LD FPM

**81-24641-10** **N**  
11 12 1 285 609  
38x50  
A SL FPM

2,5 M20 B25 (256EX) 125-126 kW (170-171 PS) 325 i (E30) 325 i X (E30) 03/86-11/93



**02-27035-03**  
11 12 9 059 240

**08-24600-03**  
11 11 1 730 875

**61-27035-20**  
11 12 1 722 735  
85 Ø  
2,05 mm

**61-27035-30**  
11 12 1 722 734  
85 Ø  
1,75 mm

**14-32001-01**  
11 12 1 726 478

**71-24469-10**  
11 12 1 730 229

**12-26058-01**  
11 34 9 059 172

**70-26058-00**  
11 34 1 288 544

**71-27037-10**  6x  
11 61 1 726 010

**71-27038-10**   
11 61 1 726 012

**71-27122-10**  2x  
11 62 1 728 489

**71-25844-20**    
18 11 1 728 364

**71-27467-00**   2x  
11 76 1 711 717



































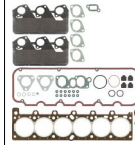



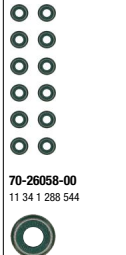



















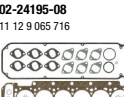

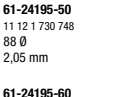

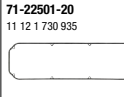

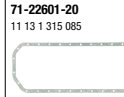

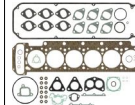





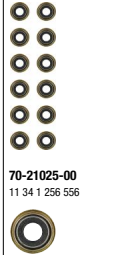





**71-24600-20**  
11 13 1 730 234

**81-17404-50**    
11 14 1 265 431  
48x65  
AB SL RD FPM



**81-20745-40**    
11 14 2 245 364  
90x110  
A SL LD FPM

**81-24641-10** **N**  
11 12 1 285 609  
38x50  
A SL FPM

BMW

Ltr.															
2,5	M20 B25 (256E1) M20 B25 (256E2) M20 B25 (256K1)	125-141 kW (170-192 PS)	Z1 325i (E30) 325i X (E30) 525i (E34)	09/83-11/93											
					<b>02-27035-03</b> 11 12 9 059 240 	<b>08-24600-03</b> 11 11 1 730 875 		<b>61-27035-20</b> 11 12 1 722 735 85 Ø 2,05 mm  <b>61-27035-30</b> 11 12 1 722 734 85 Ø 1,75 mm 	<b>14-32001-01</b> 11 12 1 726 478 	<b>71-24469-10</b> 11 12 1 730 229 	<b>12-26058-01</b> 11 34 9 059 172  <b>70-26058-00</b> 11 34 1 288 544 	<b>71-27037-10</b>  4x 11 61 1 726 010  <b>71-27038-10</b>  4x 11 61 1 726 012  <b>71-27122-10</b> 2x 11 62 1 728 489  <b>71-25844-20</b>   18 11 1 728 364 <b>71-27467-00</b>   2x 11 76 1 711 717 	<b>71-24600-20</b> 11 13 1 730 234 	<b>81-17404-50</b>   11 14 1 265 431 48x65 AB SL RD FPM  <b>81-20745-40</b>   11 14 2 245 364 90x110 A SL LD FPM  <b>81-24641-10</b> <b>N</b> 11 12 1 285 609 38x50 A SL FPM 	
2,5	M30 B25 M30 B25 A M30 B25 (256EA) M30 B25 (256VA)	107-110 kW (145-150 PS)	2.5 CS (E9) 2500 (E3) 525 (E12) 525i (E28) 725i (E23)	10/68-12/87											
					<b>02-24195-08</b> 11 12 9 065 716 	<b>08-22601-02</b> 11 00 1 267 942 	<b>15-22603-02</b>  11 14 1 735 047 	<b>61-24195-50</b> 11 12 1 730 746 88 Ø 2,05 mm  <b>61-24195-60</b> 11 12 1 730 746 88 Ø 1,75 mm 		<b>71-22501-20</b> 11 12 1 730 935 	<b>12-21025-02</b> 11 34 1 256 556 (12x)  <b>70-21025-00</b> 11 34 1 256 556 	<b>71-24887-10</b>  6x 11 61 1 730 788  <b>71-23713-10</b>  6x 11 62 1 723 851  <b>71-22012-20</b>   2x 18 11 1 723 843 	<b>71-22601-20</b> 11 13 1 315 085 	<b>81-16004-10</b>   11 14 1 715 100 42x62 A SL RD FPM  <b>81-20745-40</b>   11 14 2 245 364 90x110 A SL LD FPM 	

BMW

Ltr.   

2,5 M50 B25 (256S1) 141 kW (192 PS) 325i (E36)  
325is (E36)  
525i (E34)  
525i X (E34)  
525i 24V (E34) 03/90-07/96

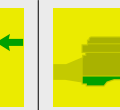
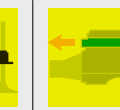
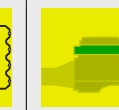

02-27820-01  
11 12 1 730 253  
1 → 09/92

08-27698-02  
11 11 9 064 460

61-31940-00  
11 12 1 726 619  
85 Ø  
1,75 mm

61-31940-10  
11 12 1 726 622  
85 Ø  
2,05 mm

14-32002-02  
11 12 1 721 938

15-28939-01  
11 12 0 034 106  
1 → 09/92

12-26058-01  
11 34 9 059 172  
1 → 09/92

71-28917-00  
11 61 1 717 259

71-28494-00  
11 62 1 728 983

71-28913-10  
18 11 1 723 692

71-27698-10  
11 13 1 437 237

81-17404-50  
11 14 1 265 431  
48x65  
AB SL RD FPM

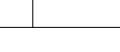
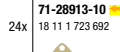
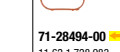
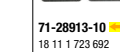
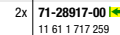
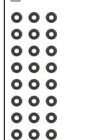
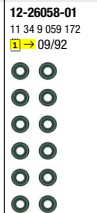
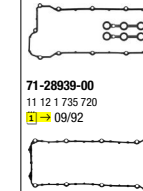
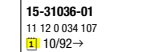
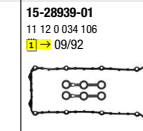
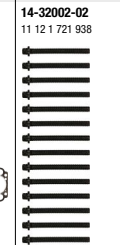
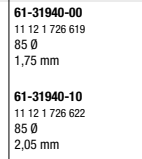
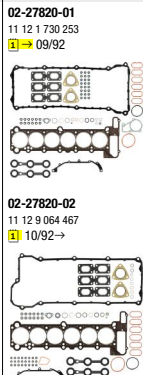

81-20745-40  
11 14 2 245 364  
90x110  
A SL LD FPM

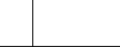
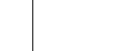
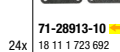
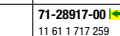
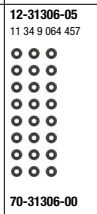
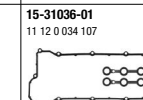
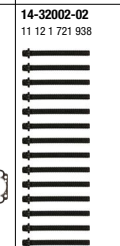
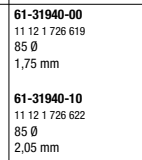
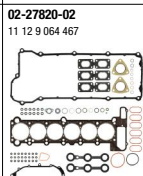

2,5 M50 B25 (256S2) 141 kW (192 PS) 325i (E36) 03/93-08/95



BMW

Ltr.   

2,5 M50 B25 (256S2) 141 kW (192 PS) 325i (E36) 325is (E36) 525i X (E34) 525i 24V (E34) 03/90-07/96 1

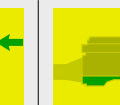
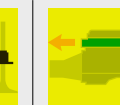
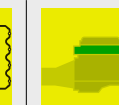

**02-27820-01**  
11 12 1 730 253  
1 → 09/92

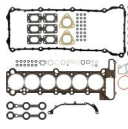

**02-27820-02**  
11 12 9 064 467  
1 → 10/92 →

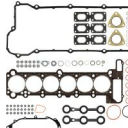

**08-27698-02**  
11 11 9 064 460



**61-31940-00**  
11 12 1 726 619  
85 Ø  
1,75 mm

**61-31940-10**  
11 12 1 726 622  
85 Ø  
2,05 mm



**14-32002-02**  
11 12 1 721 938

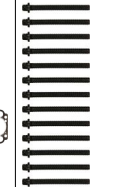

**15-28939-01**  
11 12 0 034 106  
1 → 09/92

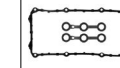

**15-31036-01**  
11 12 0 034 107  
1 → 10/92 →



**12-26058-01**  
11 34 9 059 172  
1 → 09/92

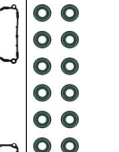

**12-31306-05**  
11 34 9 064 457  
1 → 10/92 →

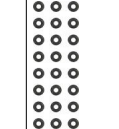

**70-26058-00**  
11 34 1 288 544  
1 → 09/92



**70-31306-00**  
11 34 2 245 151  
1 → 10/92 →



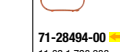

**71-28917-00**  6x  
11 61 1 717 259



**71-28494-00**  3x  
11 62 1 728 983





**71-28913-10**   2x  
18 11 1 723 692





**71-27698-10**  
11 13 1 437 237



**81-17404-50**    
11 14 1 265 431  
48x65  
AB SL RD FPM















**81-20745-40**    
11 14 2 245 364  
90x110  
A SL LD FPM





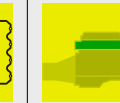
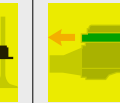
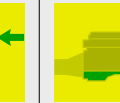
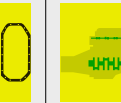









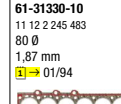
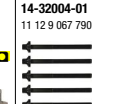
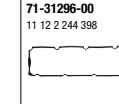
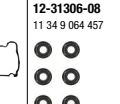

BMW

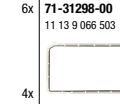

Ltr.  2,5 M51 D25 (256T1) 85 kW (115 PS) 325 td (E36) 09/91-02/98 

										
02-31296-01 11 12 2 244 328 1,87 mm 1 → 09/92	08-31298-01 11 11 9 066 462 1 → 01/94	08-31298-02 11 11 2 245 749 1 → 02/94 →	61-31330-10 11 12 2 245 483 80 Ø 1,87 mm 1 → 01/94	14-32004-01 11 12 9 067 790	71-31296-00 11 12 2 244 398 1 → 08/95	71-31344-00 11 12 2 245 686 1 → 09/95 →	12-26058-01 11 34 9 059 172 1 → 09/92	71-29398-10  11 61 2 244 391 1 → 08/95	6x 71-31298-00 11 13 9 066 503	81-17404-50  11 14 1 265 431 48x65 AB SL RD FPM
02-31296-02 11 12 9 065 445 1 → 10/92 → 1 → 08/95	08-31298-02 11 11 2 245 749 1 → 02/94 →	02-31344-01 11 12 9 070 622 1 → 09/95 →	61-31335-10 11 12 2 245 427 80 Ø 1,87 mm 1 → 02/94 →				12-31306-08 11 34 9 064 457 1 → 10/92 →	4x 71-29396-00 11 62 2 243 782 1 → 08/95	4x 71-31348-00 11 62 2 246 174 1 → 09/95 →	81-20745-40  11 14 2 245 364 90x110 A SL LD FPM
							70-26058-00 11 34 1 288 544 1 → 09/92	12x		
							70-31306-00 11 34 2 245 151 1 → 10/92 →	12x		

















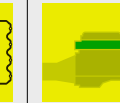
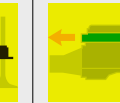
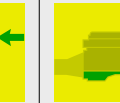
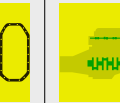
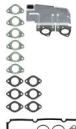
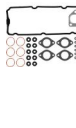



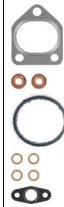
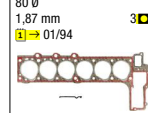
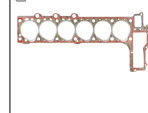
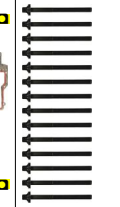
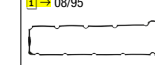

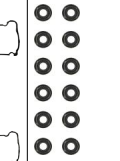

2,5 M51 D25 (256T1) 85 kW (115 PS) 525 td (E34) 03/93-08/95

										
02-31296-02 11 12 9 065 445	08-31298-01 11 11 9 066 462 1 → 01/94	08-31298-02 11 11 2 245 749 1 → 02/94 →	04-10014-01 	61-31330-10 11 12 2 245 483 80 Ø 1,87 mm 1 → 01/94	14-32004-01 11 12 9 067 790	71-31296-00 11 12 2 244 398	12-31306-08 11 34 9 064 457	6x 71-29398-10  11 61 2 244 391	4x 71-31298-00 11 13 9 066 503	81-17404-50  11 14 1 265 431 48x65 AB SL RD FPM
								4x 71-29396-00 11 62 2 243 782		81-20745-40  11 14 2 245 364 90x110 A SL LD FPM
							70-31306-00 11 34 2 245 151	12x		











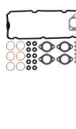

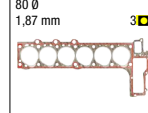
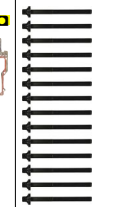
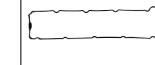
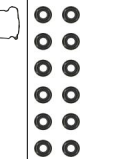
BMW

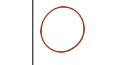
Ltr.   















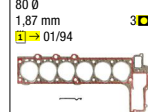
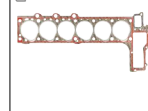
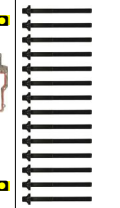

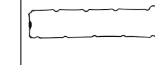
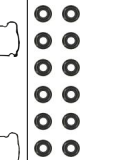

2,5 M51 D25 (256T1) 85 kW (115 PS) 525 td (E34) 03/93-07/96

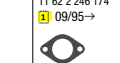
										
	<p><b>02-31296-02</b> 11 12 9 066 445 1 → 08/95</p>  <p><b>02-31344-01</b> 11 12 9 070 622 1 → 09/95 →</p> 	<p><b>08-31298-01</b> 11 11 9 066 462 1 → 01/94</p>  <p><b>08-31298-02</b> 11 11 2 245 749 1 → 02/94 →</p> 	<p><b>04-10014-01</b> </p> <p>1 → 09/95</p> 	<p><b>61-31330-10</b> 11 12 2 245 483 80 Ø 1,87 mm 1 → 01/94</p>  <p><b>61-31335-10</b> 11 12 2 245 427 80 Ø 1,87 mm 1 → 02/94 →</p> 	<p><b>14-32004-01</b> 11 12 9 067 790</p> 	<p><b>71-31296-00</b> 11 12 2 244 398 1 → 08/95</p>  <p><b>71-31344-00</b> 11 12 2 245 686 1 → 09/95 →</p> 	<p><b>12-31306-08</b> 11 34 9 064 457</p>  <p><b>70-31306-00</b> 11 34 2 245 151</p> 	<p><b>71-29398-10</b>  6x 11 61 2 244 391 1 → 08/95</p>  <p><b>71-29396-00</b> 4x 11 62 2 243 782 1 → 08/95</p>  <p><b>71-31348-00</b> 4x 11 62 2 246 174 1 → 09/95 →</p>  <p><b>71-29399-00</b>  11 62 2 244 568</p> 	<p><b>71-31298-00</b> 11 13 9 066 503</p> 	<p><b>81-17404-50 K</b> </p> <p>11 14 1 265 431 48x65 AB SL RD FPM</p>  <p><b>81-20745-40 K</b> </p> <p>11 14 2 245 364 90x110 A SL LD FPM</p> 

2,5 M51 D25 (256T1) 85-105 kW (116-143 PS) 525 td (E39) 525 tds (E39) 725 tds (E38) 01/96-05/04



















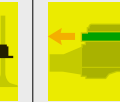
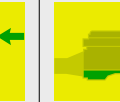
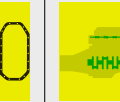
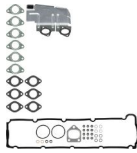
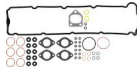
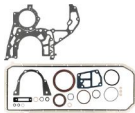
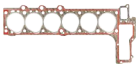

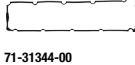
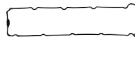
	<p><b>02-31344-01</b> 11 12 9 070 622</p> 	<p><b>08-31298-02</b> 11 11 2 245 749</p> 		<p><b>61-31335-10</b> 11 12 2 245 427 80 Ø 1,87 mm</p> 	<p><b>14-32004-01</b> 11 12 9 067 790</p> 	<p><b>71-31344-00</b> 11 12 2 245 686</p> 	<p><b>12-31306-08</b> 11 34 9 064 457</p>  <p><b>70-31306-00</b> 12x 11 34 2 245 151</p> 	<p><b>40-77534-00</b>  6x 11 61 2 245 438</p>  <p><b>71-29399-00</b>  11 62 2 244 568</p>  <p><b>71-31348-00</b> 4x 11 62 2 246 174</p> 	<p><b>71-31298-00</b> 11 13 9 066 503</p> 	<p><b>81-17404-50 K</b> </p> <p>11 14 1 265 431 48x65 AB SL RD FPM</p>  <p><b>81-20745-40 K</b> </p> <p>11 14 2 245 364 90x110 A SL LD FPM</p> 
--	---	--	--	--	---	---	---	---	---	---

2,5 M51 D25 (256T1) 105 kW (143 PS) 325 tds (E36) 05/93-02/98















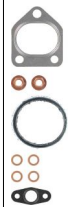
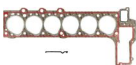
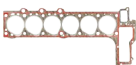

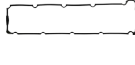
	<p><b>02-31296-02</b> 11 12 9 066 445 1 → 08/95</p>  <p><b>02-31344-01</b> 11 12 9 070 622 1 → 09/95 →</p> 	<p><b>08-31298-01</b> 11 11 9 066 462 1 → 01/94</p>  <p><b>08-31298-02</b> 11 11 2 245 749 1 → 02/94 →</p> 		<p><b>61-31330-10</b> 11 12 2 245 483 80 Ø 1,87 mm 1 → 01/94</p>  <p><b>61-31335-10</b> 11 12 2 245 427 80 Ø 1,87 mm 1 → 02/94 →</p> 	<p><b>14-32004-01</b> 11 12 9 067 790</p> 	<p><b>71-31296-00</b> 11 12 2 244 398 1 → 08/95</p>  <p><b>71-31344-00</b> 11 12 2 245 686 1 → 09/95 →</p> 	<p><b>12-31306-08</b> 11 34 9 064 457</p>  <p><b>70-31306-00</b> 12x 11 34 2 245 151</p> 	<p><b>71-29398-10</b>  6x 11 61 2 244 391 1 → 08/95</p>  <p><b>71-29396-00</b> 4x 11 62 2 243 782 1 → 08/95</p>  <p><b>71-31348-00</b> 4x 11 62 2 246 174 1 → 09/95 →</p>  <p><b>71-29399-00</b>  11 62 2 244 568</p> 	<p><b>71-31298-00</b> 11 13 9 066 503</p> 	<p><b>81-17404-50 K</b> </p> <p>11 14 1 265 431 48x65 AB SL RD FPM</p>  <p><b>81-20745-40 K</b> </p> <p>11 14 2 245 364 90x110 A SL LD FPM</p> 
--	--	--	--	--	--	--	--	---	--	---

BMW

Ltr.  2,5 M51 D25 (256T1) 105 kW (143 PS) 325 tds (E36)  03/95-04/99 

















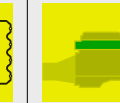
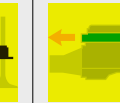
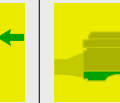
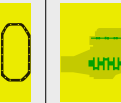



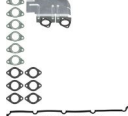

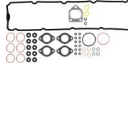





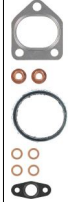

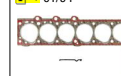

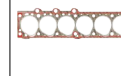
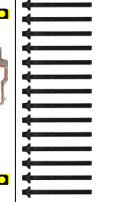

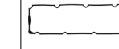

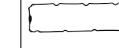

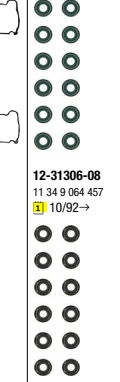

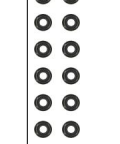







										
	<p><b>02-31296-02</b> 11 12 9 065 445 1 → 08/95</p>  <p><b>02-31344-01</b> 11 12 9 070 622 1 → 09/95 →</p> 	<p><b>08-31298-02</b> 11 11 2 245 749</p> 		<p><b>61-31335-10</b> 11 12 2 245 427 80 Ø 1,87 mm 3 →</p> 	<p><b>14-32004-01</b> 11 12 9 067 790</p> 	<p><b>71-31296-00</b> 11 12 2 244 398 1 → 08/95</p>  <p><b>71-31344-00</b> 11 12 2 245 686 1 → 09/95 →</p> 	<p><b>12-31306-08</b> 11 34 9 064 457</p>  <p><b>70-31306-00</b> 11 34 2 245 151</p> 	<p><b>71-29398-10</b> ← 6x 11 61 2 244 391 1 → 08/95</p>  <p><b>71-29396-00</b> → 4x 11 62 2 243 782 1 → 08/95</p>  <p><b>71-31348-00</b> → 4x 11 62 2 246 174 1 → 09/95 →</p>  <p><b>71-29399-00</b> → 11 62 2 244 568</p> 	<p><b>71-31298-00</b> 11 13 9 066 503</p> 	<p><b>81-17404-50</b> ← → 11 14 1 265 431 48x65 AB SL RD FPM</p>  <p><b>81-20745-40</b> ← → 11 14 2 245 364 90x110 A SL LD FPM</p> 

2,5 M51 D25 (256T1) 105 kW (143 PS) 525 tds (E34) 09/91-08/95















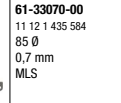
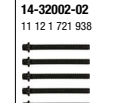
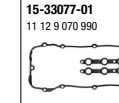
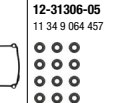
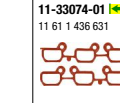
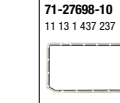
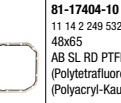
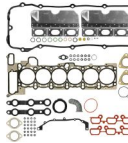



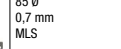
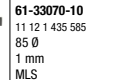
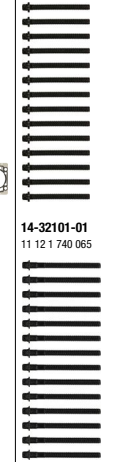
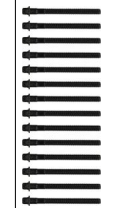

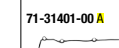

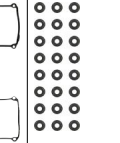



	<p><b>02-31296-01</b> 11 12 2 244 328 1 → 09/92</p>  <p><b>02-31296-02</b> 11 12 9 065 445 1 → 10/92 →</p> 	<p><b>08-31298-01</b> 11 11 9 066 462 1 → 01/94</p>  <p><b>08-31298-02</b> 11 11 2 245 749 1 → 02/94 →</p> 	<p><b>04-10014-01</b> →</p> 	<p><b>61-31330-10</b> 11 12 2 245 483 80 Ø 1,87 mm 3 → 1 → 01/94</p>  <p><b>61-31335-10</b> 11 12 2 245 427 80 Ø 1,87 mm 3 → 1 → 02/94 →</p> 	<p><b>14-32004-01</b> 11 12 9 067 790</p> 	<p><b>71-31296-00</b> 11 12 2 244 398</p> 	<p><b>12-26058-01</b> 11 34 9 059 172 1 → 09/92</p>  <p><b>12-31306-08</b> 11 34 9 064 457 1 → 10/92 →</p>  <p><b>70-26058-00</b> 11 34 1 288 544 1 → 09/92</p>  <p><b>70-31306-00</b> 11 34 2 245 151 1 → 10/92 →</p> 	<p><b>71-29398-10</b> ← 6x 11 61 2 244 391</p>  <p><b>71-29396-00</b> → 4x 11 62 2 243 782</p>  <p><b>71-29399-00</b> → 11 62 2 244 568</p> 	<p><b>71-31298-00</b> 11 13 9 066 503</p> 	<p><b>81-17404-50</b> ← → 11 14 1 265 431 48x65 AB SL RD FPM</p>  <p><b>81-20745-40</b> ← → 11 14 2 245 364 90x110 A SL LD FPM</p> 
--	--	---	---	---	---	---	---	---	---	---

BMW



Ltr.  M51 D25 (256T1) 105 kW (143 PS) 525 tds (E34)  12/91-07/96

										
	<p><b>02-31296-01</b> 11 12 2 244 328  09/92</p>  <p><b>02-31296-02</b> 11 12 9 065 445  10/92→  08/95</p>  <p><b>02-31344-01</b> 11 12 9 070 622  09/95→</p> 	<p><b>08-31298-01</b> 11 11 9 066 462  01/94</p>  <p><b>08-31298-02</b> 11 11 2 245 749  02/94→</p> 	<p><b>04-10014-01</b>  09/95</p> 	<p><b>61-31330-10</b> 11 12 2 245 483 80 Ø 1,87 mm  01/94</p>  <p><b>61-31335-10</b> 11 12 2 245 427 80 Ø 1,87 mm  02/94→</p> 	<p><b>14-32004-01</b> 11 12 9 067 790</p> 	<p><b>71-31296-00</b> 11 12 2 244 398  08/95</p>  <p><b>71-31344-00</b> 11 12 2 245 686  09/95→</p> 	<p><b>12-26058-01</b> 11 34 9 059 172  09/92</p>  <p><b>12-31306-08</b> 11 34 9 064 457  10/92→</p>  <p><b>70-26058-00</b> 12x 11 34 1 288 544  09/92</p>  <p><b>70-31306-00</b> 12x 11 34 2 245 151  10/92→</p> 	<p><b>71-29398-10</b>  6x 11 61 2 244 391  08/95</p>  <p><b>71-29396-00</b> 4x 11 62 2 243 782  08/95</p>  <p><b>71-31348-00</b> 4x 11 62 2 246 174  09/95→</p>  <p><b>71-29399-00</b> 11 62 2 244 568</p> 	<p><b>71-31298-00</b> 11 13 9 066 503</p> 	<p><b>81-17404-50 K</b>  11 14 1 265 431 48x65 AB SL RD FPM</p>  <p><b>81-20745-40 K</b>  11 14 2 245 364 90x110 A SL LD FPM</p> 

2,5 M52 B25 (256S3) 120-125 kW (163-170 PS) 323 i (E46) 03/97-12/00  
M52 B25 (256S4) 323 ii (E36) 523 i (E39)

										
	<p><b>02-33070-01</b> 11 12 1 436 822 +11 12 7 501 304 +11 62 1 732 969 (2x)</p> 	<p><b>08-27698-05</b> 11 11 1 432 478</p> 	<p><b>15-33097-01</b> </p> 	<p><b>61-33070-00</b> 11 12 1 435 584 85 Ø 0,7 mm MLS</p>  <p><b>61-33070-10</b> 11 12 1 435 585 85 Ø 1 mm MLS</p> 	<p><b>14-32002-02</b> 11 12 1 721 938</p>  <p><b>14-32101-01</b> 11 12 1 740 065</p> 	<p><b>15-33077-01</b> 11 12 9 070 990</p>  <p><b>71-31401-00 A</b></p>  <p><b>71-31402-00 I</b> 2x</p> 	<p><b>12-31306-05</b> 11 34 9 064 457</p>  <p><b>70-31306-00</b> 24x 11 34 2 245 151</p> 	<p><b>11-33074-01</b>  11 61 1 436 631</p>  <p><b>71-34834-00</b> 2x 11 62 1 732 969</p>  <p><b>71-28913-10</b>   2x 18 11 1 723 692</p> 	<p><b>71-27698-10</b> 11 13 1 437 237</p> 	<p><b>81-17404-10 K</b>  11 14 2 249 532 48x65 AB SL RD PTFE (Polytetrafluorethylen)/ACM (Polyacryl-Kautschuk)</p>  <p><b>81-17404-50 K</b>  11 14 1 265 431 48x65 AB SL RD FPM</p>  <p><b>81-20745-40 K</b>  11 14 2 245 364 90x110 A SL LD FPM</p> 

BMW

Ltr.  M52 B25 (256S3) 125 kW (170 PS) 323i (E36)  05/95-11/98 

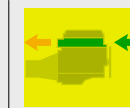

2,5 M52 B25 (256S3) 125 kW (170 PS) 323i (E36) 05/95-11/98

**02-31940-01**  
11 12 1 740 984  
 09/95

**08-27698-03**  
11 11 1 740 981

**61-31940-00**  
11 12 1 726 619  
85 Ø  
1,75 mm

**61-31940-10**  
11 12 1 726 622  
85 Ø  
2,05 mm

**14-32002-02**  
11 12 1 721 938

**15-31036-01**  
11 12 0 034 107  
 09/95

**12-31306-05**  
11 34 9 064 457

**71-31403-00 I**  2x  
11 61 1 740 069

**71-31404-00**  2x  
11 62 1 744 252

**71-28913-10**   2x  
18 11 1 723 692

**71-27698-10**  
11 13 1 437 237

**81-17404-10 K**   
11 14 2 249 532  
48x65  
AB SL RD PTFE  
(Polytetrafluorethylen)/ACM  
(Polyacryl-Kautschuk)

**81-17404-50 K**   
11 14 1 265 431  
48x65  
AB SL RD FPM

**81-20745-40 K**   
11 14 2 245 364  
90x110  
A SL LD FPM

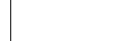
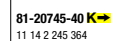
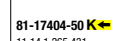
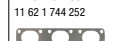
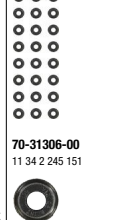
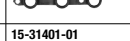
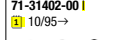
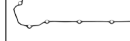
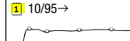
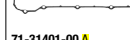
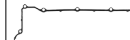
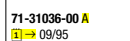
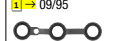
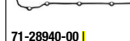
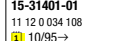
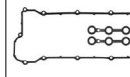
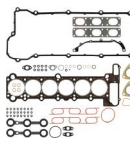

2,5 M52 B25 (256S3) 125 kW (170 PS) 323i (E36) 09/95-09/00

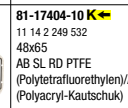
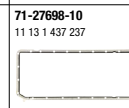
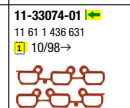
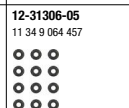
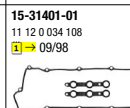
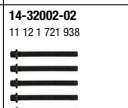
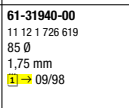
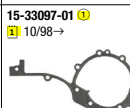
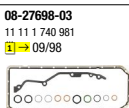
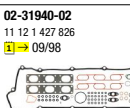

2,5 M52 B25 (256S3) 125 kW (170 PS) 323i (E36) 09/95-09/00

**02-31940-02**  
11 12 1 427 826  
 09/98

**08-27698-03**  
11 11 1 740 981  
 09/98

**15-33097-01**   10/98→

**61-31940-00**  
11 12 1 726 619  
85 Ø  
1,75 mm  
 09/98

**61-31940-10**  
11 12 1 726 622  
85 Ø  
2,05 mm  
 09/98

**14-32002-02**  
11 12 1 721 938

**15-31401-01**  
11 12 0 034 108  
 09/98

**12-31306-05**  
11 34 9 064 457

**11-33074-01**   2x  
11 61 1 436 631  
 10/98→

**71-31403-00 I**  2x  
11 61 1 740 069  
 09/98

**71-31404-00**  2x  
11 62 1 744 252  
 09/98

**71-34834-00**  2x  
11 62 1 732 969  
 10/98→

**71-28913-10**   2x  
18 11 1 723 692

**71-27698-10**  
11 13 1 437 237



**81-17404-10 K**   
11 14 2 249 532  
48x65  
AB SL RD PTFE  
(Polytetrafluorethylen)/ACM  
(Polyacryl-Kautschuk)

**81-17404-50 K**   
11 14 1 265 431  
48x65  
AB SL RD FPM

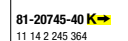
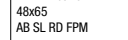
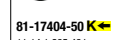
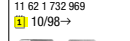
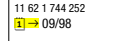
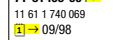
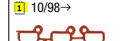
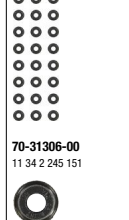
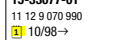
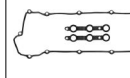
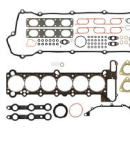
**81-20745-40 K**   
11 14 2 245 364  
90x110  
A SL LD FPM



BMW

Ltr.   

2,5 M52 B25 (256S3) 125 kW (170 PS) 323i (E36) 05/95-08/00  
M52 B25 (256S4) 523i (E39)

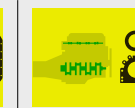
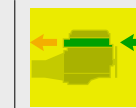

02-31940-01  
11 12 1 740 984  
1 → 09/95

08-27698-03  
11 11 1 740 981  
1 → 09/98

15-33097-01   
11 10/98 →

61-31940-00  
11 12 1 726 619  
85 Ø  
1,75 mm  
1 → 09/98

61-31940-10  
11 12 1 726 622  
85 Ø  
2,05 mm  
1 → 09/98

14-32002-02  
11 12 1 721 938

15-31036-01  
11 12 0 034 107  
1 → 09/95

12-31306-05  
11 34 9 064 457

11-33074-01   
11 61 1 436 631  
1 → 10/98 →

71-31403-00   
11 61 1 740 069  
1 → 09/98

71-31404-00   
11 62 1 744 252  
1 → 09/98

71-34834-00   
11 62 1 732 969  
1 → 10/98 →

71-28913-10   
18 11 1 723 692

71-27698-10  
11 13 1 437 237

81-17404-10   
11 14 2 249 532  
48x65  
AB SL RD PTFE  
(Polytetrafluorethylen)/ACM  
(Polyacryl-Kautschuk)

81-17404-50   
11 14 1 265 431  
48x65  
AB SL RD FPM

81-20745-40   
11 14 2 245 364  
90x110  
A SL LD FPM

02-31940-02  
11 12 1 427 826  
1 → 10/95 →  
1 → 09/98

08-27698-05  
11 11 1 432 478  
1 → 10/98 →

02-33070-01  
11 12 1 436 822  
+11 12 7 501 304  
+11 62 1 732 969 (2x)  
1 → 10/98 →

61-33070-00  
11 12 1 435 584  
85 Ø  
0,7 mm  
MLS  
1 → 10/98 →

61-33070-10  
11 12 1 435 585  
85 Ø  
1 mm  
MLS  
1 → 10/98 →

14-32101-01  
11 12 1 740 065

15-33077-01  
11 12 9 070 990  
1 → 10/98 →

71-28940-00 I   
1 → 09/95

71-31036-00 A   
1 → 09/95

71-31401-00 A   
1 → 10/95 →

71-31402-00 I   
1 → 10/95 →

71-28940-00 I 2x

71-31036-00 A 2x

71-31401-00 A 2x

71-31402-00 I 2x

71-31036-00 24x

71-31306-00 24x

71-31403-00 I   
11 61 1 740 069

71-31404-00   
11 62 1 744 252

71-28913-10   
18 11 1 723 692

71-27698-10  
11 13 1 437 237

81-17404-10   
11 14 2 249 532  
48x65  
AB SL RD PTFE  
(Polytetrafluorethylen)/ACM  
(Polyacryl-Kautschuk)

81-17404-50   
11 14 1 265 431  
48x65  
AB SL RD FPM

81-20745-40   
11 14 2 245 364  
90x110  
A SL LD FPM

2,5 M52 B25 (256S4) 120 kW (163 PS) 523i (E39) 09/98-08/00

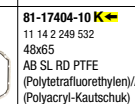
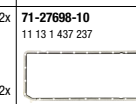
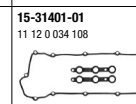
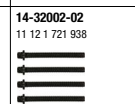
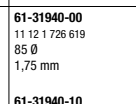
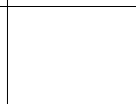
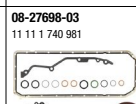
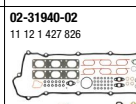

02-31940-02  
11 12 1 427 826

08-27698-03  
11 11 1 740 981

61-31940-00  
11 12 1 726 619  
85 Ø  
1,75 mm

61-31940-10  
11 12 1 726 622  
85 Ø  
2,05 mm

14-32002-02  
11 12 1 721 938

14-32101-01  
11 12 1 740 065

15-31401-01  
11 12 0 034 108

12-31306-05  
11 34 9 064 457

71-31403-00 I   
11 61 1 740 069

71-31404-00   
11 62 1 744 252

71-28913-10   
18 11 1 723 692

71-31403-00 I 2x

71-31404-00 2x

71-28913-10 2x

71-31306-00 24x



71-27698-10  
11 13 1 437 237

81-17404-10   
11 14 2 249 532  
48x65  
AB SL RD PTFE  
(Polytetrafluorethylen)/ACM  
(Polyacryl-Kautschuk)

81-17404-50   
11 14 1 265 431  
48x65  
AB SL RD FPM

81-20745-40   
11 14 2 245 364  
90x110  
A SL LD FPM

BMW

Ltr.  M52 B25 (256S4) 125 kW (170 PS)  Z3 2.5 i (E36)  09/98-09/00

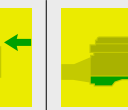
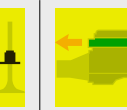
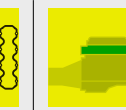

2,5 M52 B25 (256S4) 125 kW (170 PS) Z3 2.5 i (E36) 09/98-09/00

**02-33070-01** 2x  
11 12 1 436 822  
+11 12 7 501 304  
+11 62 1 732 969 (2x)



**08-27698-05**  
11 11 1 432 478



**61-33070-00**  
11 12 1 435 584  
85 Ø  
0,7 mm  
MLS

**61-33070-10**  
11 12 1 435 585  
85 Ø  
1 mm  
MLS



**14-32101-01**  
11 12 1 740 065



**15-33077-01**  
11 12 9 070 990



**12-31306-08** 2x  
11 34 9 064 457

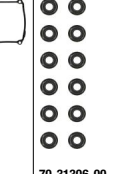

**11-33074-01**  2x  
11 61 1 436 631





**71-34834-00** 2x  
11 62 1 732 969





**71-27698-10**  
11 13 1 437 237



**81-17404-10**  **K**  
11 14 2 249 532  
48x65  
AB SL RD PTFE  
(Polytetrafluorethylen)/ACM  
(Polyacryl-Kautschuk)



**81-20745-40**  **K**  
11 14 2 245 364  
90x110  
A SL LD FPM



2,5 M52 B25 (256S4) 125 kW (170 PS) 323 Ci (E46) 04/99-09/00

**02-33070-01**  
11 12 1 436 822  
+11 12 7 501 304  
+11 62 1 732 969 (2x)

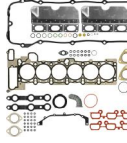

**08-27698-05**  
11 11 1 432 478



**15-33097-01** 

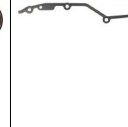

**61-33070-00**  
11 12 1 435 584  
85 Ø  
0,7 mm  
MLS

**61-33070-10**  
11 12 1 435 585  
85 Ø  
1 mm  
MLS



**14-32002-02**  
11 12 1 721 938





**15-33077-01**  
11 12 9 070 990

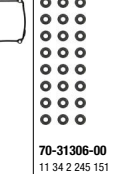

**12-31306-05**  
11 34 9 064 457



**11-33074-01**  2x  
11 61 1 436 631





**71-34834-00** 2x  
11 62 1 732 969





**71-27698-10**  
11 13 1 437 237





**81-17404-10**  **K**  
11 14 2 249 532  
48x65  
AB SL RD PTFE  
(Polytetrafluorethylen)/ACM  
(Polyacryl-Kautschuk)





**81-17404-50**  **K**  
11 14 1 265 431  
48x65  
AB SL RD FPM





















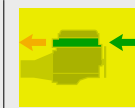











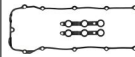

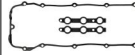
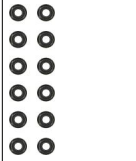
**81-20745-40**  **K**  
11 14 2 245 364  
90x110  
A SL LD FPM













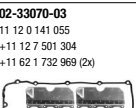

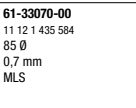
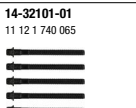
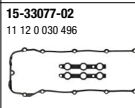
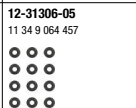

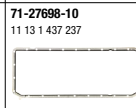

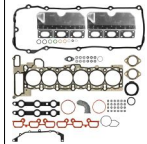

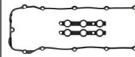
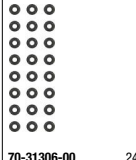

BMW

Ltr.    1

2,5 M54 B25 (256S3) 141 kW (192 PS)

										
	<p><b>02-33070-02</b> 11 12 7 507 597 +11 12 7 501 304 +11 62 1 732 969 (2x)  09/02</p>  <p><b>02-33077-01</b> 11 12 7 507 597  09/02</p>  <p><b>02-33070-03</b> 11 12 0 141 055 +11 12 7 501 304 +11 62 1 732 969 (2x)  10/02→</p> 	<p><b>08-27698-05</b> 11 11 1 432 478</p> 		<p><b>61-33070-00</b> 11 12 1 435 584 85 0 0,7 mm MLS</p> <p><b>61-33070-10</b> 11 12 1 435 585 85 0 1 mm MLS</p> 	<p><b>14-32101-01</b> 11 12 1 740 065</p> 	<p><b>15-33077-01</b> 11 12 9 070 990  09/02</p>  <p><b>15-33077-02</b> 11 12 0 030 496  10/02→</p> 	<p><b>12-31306-08</b> 11 34 9 064 457</p>  <p><b>70-31306-00</b> 11 34 2 245 151</p> 	<p><b>11-33074-01</b> </p> <p>11 61 1 436 631</p>  <p><b>71-34834-00</b> </p> <p>11 62 1 732 969</p> 	<p><b>71-27698-10</b> 11 13 1 437 237</p> 	<p><b>81-28498-00</b> </p> <p>11 14 1 435 848 44x60 A SL RD FPM</p>  <p><b>81-20745-40</b> </p> <p>11 14 2 245 364 90x110 A SL LD FPM</p> 

2,5 M54 B25 (256S5) 137-141 kW (186-192 PS) X3 2.5 i (E83)  
Z3 2.5 i (E36)  
Z4 2.5 i (E85)  
Z4 2.5 i (E86)  
525 i (E60)  
525 i (E61) 10/00-12/10

										
	<p><b>02-33070-03</b> 11 12 0 141 055 +11 12 7 501 304 +11 62 1 732 969 (2x)</p> 	<p><b>08-27698-05</b> 11 11 1 432 478</p> 		<p><b>61-33070-00</b> 11 12 1 435 584 85 0 0,7 mm MLS</p> <p><b>61-33070-10</b> 11 12 1 435 585 85 0 1 mm MLS</p> 	<p><b>14-32101-01</b> 11 12 1 740 065</p> 	<p><b>15-33077-02</b> 11 12 0 030 496</p> 	<p><b>12-31306-05</b> 11 34 9 064 457</p>  <p><b>70-31306-00</b> 11 34 2 245 151</p> 	<p><b>11-33074-01</b> </p> <p>11 61 1 436 631</p>  <p><b>71-34834-00</b> </p> <p>11 62 1 732 969</p> 	<p><b>71-27698-10</b> 11 13 1 437 237</p> 	<p><b>81-17404-50</b> </p> <p>11 14 1 265 431 48x65 AB SL RD FPM</p>  <p><b>81-20745-40</b> </p> <p>11 14 2 245 364 90x110 A SL LD FPM</p> 



BMW

Ltr.														
2,5	M54 B25 (256S5)	137-141 kW (186-192 PS)	09/00-12/06		<p><b>02-33070-02</b> 11 12 7 507 597 +11 12 7 501 304 +11 62 1 732 969 (2x) 1 → 09/02</p> <p><b>02-33077-01</b> 11 12 7 507 597 1 → 09/02</p> <p><b>02-33070-03</b> 11 12 0 141 055 +11 12 7 501 304 +11 62 1 732 969 (2x) 1 10/02 →</p>	<p><b>08-27698-05</b> 11 11 1 432 478</p>		<p><b>61-33070-00</b> 11 12 1 435 584 85 0 0,7 mm MLS</p> <p><b>61-33070-10</b> 11 12 1 435 585 85 0 1 mm MLS</p>	<p><b>14-32101-01</b> 11 12 1 740 065</p>	<p><b>15-33077-01</b> 11 12 9 070 990 1 → 09/02</p> <p><b>15-33077-02</b> 11 12 0 030 496 1 10/02 →</p>	<p><b>12-31306-05</b> 11 34 9 064 457</p> <p><b>70-31306-00</b> 11 34 2 245 151</p>	<p><b>11-33074-01</b> </p> <p>11 61 1 436 631</p> <p><b>71-34834-00</b>  2x</p> <p>11 62 1 732 969</p>	<p><b>71-27698-10</b> 11 13 1 437 237</p>	<p><b>81-17404-50</b> </p> <p>11 14 1 265 431 48x65 AB SL RD FPM</p> <p><b>81-20745-40</b> </p> <p>11 14 2 245 364 90x110 A SL LD FPM</p>
2,5	M54 B25 (256S5)	141 kW (192 PS)	09/00-06/03		<p><b>02-33070-03</b> 11 12 0 141 055 +11 12 7 501 304 +11 62 1 732 969 (2x)</p>	<p><b>08-27698-05</b> 11 11 1 432 478</p>		<p><b>61-33070-00</b> 11 12 1 435 584 85 0 0,7 mm MLS</p> <p><b>61-33070-10</b> 11 12 1 435 585 85 0 1 mm MLS</p>	<p><b>14-32101-01</b> 11 12 1 740 065</p>	<p><b>15-33077-01</b> 11 12 9 070 990 1 → 09/02</p> <p><b>15-33077-02</b> 11 12 0 030 496 1 10/02 →</p>	<p><b>12-31306-05</b> 11 34 9 064 457</p> <p><b>70-31306-00</b> 11 34 2 245 151</p>	<p><b>11-33074-01</b> </p> <p>11 61 1 436 631</p> <p><b>71-34834-00</b>  2x</p> <p>11 62 1 732 969</p>	<p><b>71-27698-10</b> 11 13 1 437 237</p>	<p><b>81-17404-50</b> </p> <p>11 14 1 265 431 48x65 AB SL RD FPM</p> <p><b>81-20745-40</b> </p> <p>11 14 2 245 364 90x110 A SL LD FPM</p>

BMW

Ltr.    1

2,5 M57 D25 (256D1) 120 kW (163 PS) 525 d (E39) 02/00-05/04

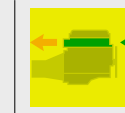

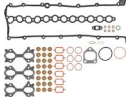

02-35176-01  
11 12 2 248 985



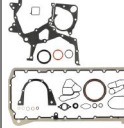

08-37313-01  
11 11 2 248 975



04-10029-01 



61-35005-00  
11 12 2 354 013  
80 Ø  
1,45 mm  
MLS 

61-35005-10  
11 12 2 354 014  
80 Ø  
1,55 mm  
MLS 

61-35005-20  
11 12 2 354 015  
80 Ø  
1,65 mm  
MLS 

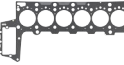

14-32004-01  
11 12 9 067 790



71-37402-00  
11 12 7 796 378

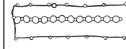

12-35172-02  
11 34 9 071 732

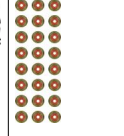

70-35172-00  
11 34 2 247 171



11-77546-01 

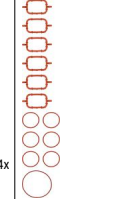



71-37313-00  
11 13 2 246 586



81-37002-00 

11 11 8 604 931  
55x68  
AB RD PTFE



81-20745-00 



11 14 2 249 533  
90x110  
AB SL LD PTFE  
(Polytetrafluorethylen)/ACM  
(Polyacryl-Kautschuk)



71-33109-10 

11 61 2 246 944 6x



71-77546-00  

11 61 2 246 945 6x



71-33027-00 

11 62 7 796 480 3x



2,5 M57 D25 (256D2) 120 kW (163 PS) 525 d (E61) 03/04-03/07

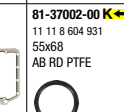
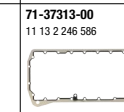
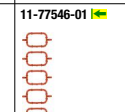
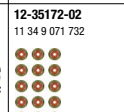
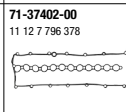
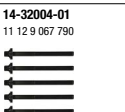
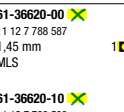
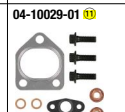
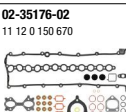

02-35176-02  
11 12 0 150 670



08-37313-02  
11 11 7 790 458



04-10029-01 



61-36620-00 

11 12 7 788 587  
1,45 mm  
MLS 

61-36620-10 

11 12 7 788 588  
1,55 mm  
MLS 

61-36620-20 

11 12 7 788 589  
1,65 mm  
MLS 



14-32004-01  
11 12 9 067 790



71-37402-00  
11 12 7 796 378

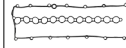

12-35172-02  
11 34 9 071 732



70-35172-00  
11 34 2 247 171



11-77546-01 



71-37313-00  
11 13 2 246 586



81-37002-00 

11 11 8 604 931  
55x68  
AB RD PTFE



81-90032-00 

11 14 7 787 262



71-33109-10 

11 61 2 246 944 6x



71-77546-00  

11 61 2 246 945 6x





















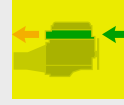

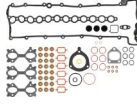





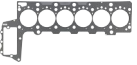

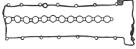

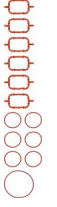
71-37403-00 

11 62 7 796 177 3x











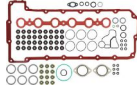
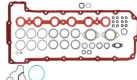

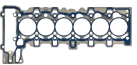

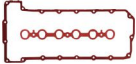



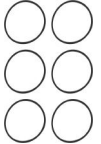

BMW

Ltr.     
 2,5 M57 D25 (256D2) 120-130 kW (163-177 PS) 525 d (E60) 03/04-03/10  
 525 d (E61)

										
	<p><b>02-35176-02</b> 11 12 0 150 670</p> 	<p><b>08-37313-02</b> 11 11 7 790 458</p> 	<p><b>04-10029-01</b> </p> 	<p><b>61-36620-00</b>  11 12 7 788 587 1,45 mm MLS</p> <p><b>61-36620-10</b>  11 12 7 788 588 1,55 mm MLS</p> <p><b>61-36620-20</b>  11 12 7 788 589 1,65 mm MLS</p> 	<p><b>14-32004-01</b> 11 12 9 067 790</p> 	<p><b>71-37402-00</b> 11 12 7 796 378</p> 	<p><b>12-35172-02</b> 11 34 9 071 732</p> 	<p><b>11-77546-01</b> </p>  <p><b>71-33109-10</b>  6x</p> <p><b>71-77546-00</b>   6x</p> <p><b>71-37403-00</b>  3x</p> 	<p><b>71-37313-00</b> 11 13 2 246 586</p> 	<p><b>81-37002-00</b>  11 11 8 604 931 55x68 AB RD PTFE</p>  <p><b>81-90032-00</b>  11 14 7 787 262</p> 

2,5 N52 B25 163 kW (222 PS) 325 i (E90) 09/08-12/09

	<p><b>02-37289-01</b> 11 12 7 548 921 +11 34 0 035 853 +11 34 0 032 582</p>  <p><b>02-37289-02</b> 11 12 7 548 921</p> 	<p><b>08-38669-01</b> 11 11 7 548 101</p> 	<p><b>61-35535-00</b> 11 12 7 555 310 83 Ø 1,2 mm MLS</p> <p><b>61-35535-10</b> 11 12 7 555 311 83 Ø 1,5 mm MLS</p> 	<p><b>14-32315-01</b> 11 12 7 548 799</p> 	<p><b>15-37289-01</b> 11 12 7 581 215</p> 	<p><b>12-36866-01</b> 11 34 0 034 068</p>  <p><b>12-36866-02</b> 11 34 0 032 582</p>  <p><b>12-37256-01</b> 11 34 0 035 853</p> 	<p><b>11-37133-01</b>  11 61 7 547 242</p>  <p><b>71-37134-00</b>  6x</p> <p><b>71-37136-00</b>   2x</p> 	<p><b>71-38669-00</b> 11 13 7 548 031</p> 	<p><b>81-34057-00</b>  11 11 7 547 842 65x79 A SL RD PTFE ACM</p>  <p><b>81-37122-00</b>  11 11 7 584 398 90x110 A SL LD PTFE (Polytetrafluorethylen)/ACM (Polyacryl-Kautschuk)</p> 
--	--	--	---	---	---	--	--	---	---

BMW

















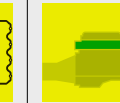
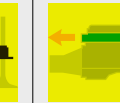
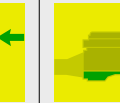
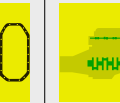

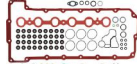

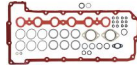



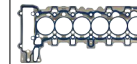

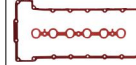



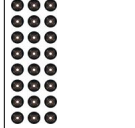

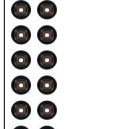

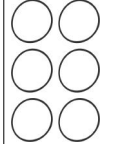

Ltr.	Motor	Power	Models	Years	Image 1	Image 2	Image 3	Image 4	Image 5	Image 6	Image 7	Image 8	Image 9	Image 10	Image 11	Image 12
2,5	N52 B25 A	130-150 kW (177-204 PS)	323 i (E90) 323 i (E91) 523 i (E60) 523 i (E61) 523 i (F11)	09/05-12/11												
					<p><b>02-37289-01</b> 11 12 7 548 921 +11 34 0 035 853 +11 34 0 032 582</p> <p><b>02-37289-02</b> 11 12 7 548 921</p>	<p><b>08-38669-01</b> 11 11 7 548 101</p>		<p><b>61-35535-00</b> 11 12 7 555 310 83 Ø 1,2 mm MLS</p> <p><b>61-35535-10</b> 11 12 7 555 311 83 Ø 1,5 mm MLS</p>	<p><b>14-32315-01</b> 11 12 7 548 799</p>	<p><b>15-37289-01</b> 11 12 7 581 215</p>	<p><b>12-36866-01</b> 11 34 0 034 068</p>	<p><b>11-37133-01</b> </p> <p>11 61 7 547 242</p> <p><b>71-37134-00</b>  6x</p> <p>18 40 7 530 606</p> <p><b>71-37136-00</b>   2x</p> <p>18 10 7 549 447</p>	<p><b>71-38669-00</b> 11 13 7 548 031</p>	<p><b>81-34057-00</b> </p> <p>11 11 7 547 842 65x79 A SL RD PTFE ACM</p> <p><b>81-37122-00</b> </p> <p>11 11 7 584 398 90x110 A SL LD PTFE (Polytetrafluorethylen)/ACM (Polyacryl-Kautschuk)</p>		
2,5	N52 B25 A	130-160 kW (177-218 PS)	Z4 2.5 i (E85) Z4 2.5 si (E85) 325 i (E90) 325 xi (E90) 523 i (E60) 523 i (E61) 525 i (E60) 525 i (E61) 525 xi (E60) 525 xi (E61)	10/04-12/11												
					<p><b>02-37289-01</b> 11 12 7 548 921 +11 34 0 035 853 +11 34 0 032 582</p> <p><b>02-37289-02</b> 11 12 7 548 921</p>	<p><b>08-38669-01</b> 11 11 7 548 101</p>		<p><b>61-35535-00</b> 11 12 7 555 310 83 Ø 1,2 mm MLS</p> <p><b>61-35535-10</b> 11 12 7 555 311 83 Ø 1,5 mm MLS</p>	<p><b>14-32315-01</b> 11 12 7 548 799</p>	<p><b>15-37289-01</b> 11 12 7 581 215</p>	<p><b>12-36866-02</b> 11 34 0 032 582  03/06</p> <p><b>12-36866-01</b> 11 34 0 034 068  04/06→</p>	<p><b>11-37133-01</b> </p> <p>11 61 7 547 242</p> <p><b>71-37134-00</b>  6x</p> <p>18 40 7 530 606</p> <p><b>71-37136-00</b>   2x</p> <p>18 10 7 549 447</p>	<p><b>71-38669-00</b> 11 13 7 548 031</p>	<p><b>81-34057-00</b> </p> <p>11 11 7 547 842 65x79 A SL RD PTFE ACM</p> <p><b>81-37122-00</b> </p> <p>11 11 7 584 398 90x110 A SL LD PTFE (Polytetrafluorethylen)/ACM (Polyacryl-Kautschuk)</p>		

BMW











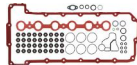
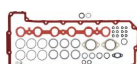

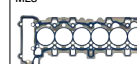

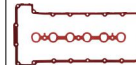

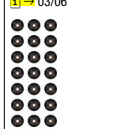

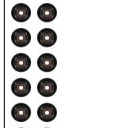

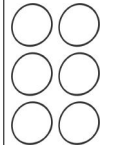

Ltr.	Motor	Power	Model	Year	Image 1	Image 2	Image 3	Image 4	Image 5	Image 6	Image 7	Image 8	Image 9	Image 10	Image 11	Image 12
2,5	N52 B25 A	140 kW (190 PS)	323 i (E93)	03/07-09/11												
						<p><b>02-37289-01</b> 11 12 7 548 921 +11 34 0 035 853 +11 34 0 032 582</p> <p><b>02-37289-02</b> 11 12 7 548 921</p>	<p><b>08-38669-01</b> 11 11 7 548 101</p>		<p><b>61-35535-00</b> 11 12 7 555 310 83 Ø 1,2 mm MLS</p> <p><b>61-35535-10</b> 11 12 7 555 311 83 Ø 1,5 mm MLS</p>	<p><b>14-32315-01</b> 11 12 7 548 799</p>	<p><b>15-37289-01</b> 11 12 7 581 215</p>	<p><b>12-36866-01</b> 11 34 0 034 068</p>	<p><b>11-37133-01</b> </p> <p>11 61 7 547 242</p>	<p><b>71-38669-00</b> 11 13 7 548 031</p>	<p><b>81-34057-00 K</b> </p> <p>11 11 7 547 842 65x79 A SL RD PTFE ACM</p> <p><b>81-37122-00 K</b> </p> <p>11 11 7 584 398 90x110 A SL LD PTFE (Polytetrafluorethylen)/ACM (Polyacryl-Kautschuk)</p>	
2,5	N52 B25 A	150 kW (204 PS)	325 i (E92) 325 i xDrive (E92)	03/10-10/13		<p><b>02-37159-01</b> 11 12 7 571 963 +11 34 0 035 853</p>	<p><b>08-38669-01</b> 11 11 7 548 101</p>		<p><b>61-35535-00</b> 11 12 7 555 310 83 Ø 1,2 mm MLS</p> <p><b>61-35535-10</b> 11 12 7 555 311 83 Ø 1,5 mm MLS</p>	<p><b>14-32315-01</b> 11 12 7 548 799</p>	<p><b>15-37159-01</b> 11 12 7 582 245</p>	<p><b>12-36866-01</b> 11 34 0 034 068</p>	<p><b>11-37133-01</b> </p> <p>11 61 7 547 242</p>	<p><b>71-38669-00</b> 11 13 7 548 031</p>	<p><b>81-34057-00 K</b> </p> <p>11 11 7 547 842 65x79 A SL RD PTFE ACM  02/11</p> <p><b>81-37122-00 K</b> </p> <p>11 11 7 584 398 90x110 A SL LD PTFE (Polytetrafluorethylen)/ACM (Polyacryl-Kautschuk)</p>	
2,5	N52 B25 A N52 B25 C	150-160 kW (204-218 PS)	X3 xDrive 25 i (E83) Z4 (E89) 325 i (E92) 325 i (E93) 325 xi (E92)	06/06		<p><b>02-37159-01</b> 11 12 7 571 963 +11 34 0 035 853</p>	<p><b>08-38669-01</b> 11 11 7 548 101</p>		<p><b>61-35535-00</b> 11 12 7 555 310 83 Ø 1,2 mm MLS</p> <p><b>61-35535-10</b> 11 12 7 555 311 83 Ø 1,5 mm MLS</p>	<p><b>14-32315-01</b> 11 12 7 548 799</p>	<p><b>15-37159-01</b> 11 12 7 582 245</p>	<p><b>12-36866-01</b> 11 34 0 034 068</p>	<p><b>11-37133-01</b> </p> <p>11 61 7 547 242</p>	<p><b>71-38669-00</b> 11 13 7 548 031</p>	<p><b>81-34057-00 K</b> </p> <p>11 11 7 547 842 65x79 A SL RD PTFE ACM</p> <p><b>81-37122-00 K</b> </p> <p>11 11 7 584 398 90x110 A SL LD PTFE (Polytetrafluorethylen)/ACM (Polyacryl-Kautschuk)</p>	

BMW

Ltr.  2,5 N52 B25 A 155 kW (211 PS) Z4 2.5 si (E85) 09/05-02/09 

















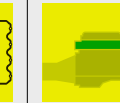
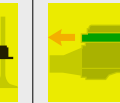
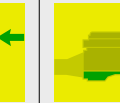
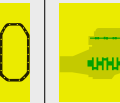
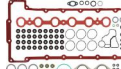
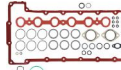

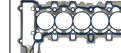

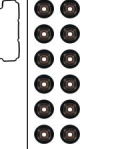
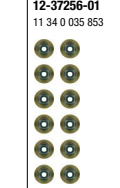

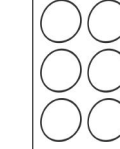
										
	<p><b>02-37289-01</b> 11 12 7 548 921 +11 34 0 035 853 +11 34 0 032 582  10/06</p>  <p><b>02-37289-02</b> 11 12 7 548 921  10/06</p>  <p><b>02-37159-01</b> 11 12 7 571 963 +11 34 0 035 853  11/06→</p> 	<p><b>08-38669-01</b> 11 11 7 548 101</p> 		<p><b>61-35535-00</b> 11 12 7 555 310 83 Ø 1,2 mm MLS</p> <p><b>61-35535-10</b> 11 12 7 555 311 83 Ø 1,5 mm MLS</p> 	<p><b>14-32315-01</b> 11 12 7 548 799</p> 	<p><b>15-37289-01</b> 11 12 7 581 215  10/06</p>  <p><b>15-37159-01</b> 11 12 7 582 245  11/06→</p> 	<p><b>12-36866-02</b> 11 34 0 032 582  03/06</p>  <p><b>12-36866-01</b> 11 34 0 034 068  04/06→</p>  <p><b>12-37256-01</b> 11 34 0 035 853</p> 	<p><b>11-37133-01</b>  6x 11 61 7 547 242</p>  <p><b>71-37134-00</b>  6x 18 40 7 530 606</p>  <p><b>71-37136-00</b>   2x 18 10 7 549 447</p> 	<p><b>71-38669-00</b> 11 13 7 548 031</p> 	<p><b>81-34057-00</b>   11 11 7 547 842 65x79 A SL RD PTFE ACM</p>  <p><b>81-37122-00</b>   11 11 7 584 398 90x110 A SL LD PTFE (Polytetrafluorethylen)/ACM (Polyacryl-Kautschuk)</p> 

2,5 N52 B25 A 155 kW (211 PS) 525 i (E60) 03/05-05/10 525 i (E61)











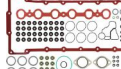
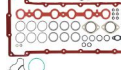





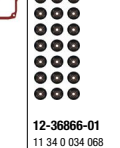
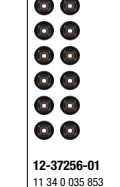
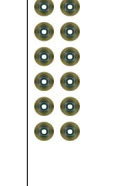

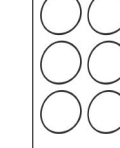
	<p><b>02-37289-01</b> 11 12 7 548 921 +11 34 0 035 853 +11 34 0 032 582</p>  <p><b>02-37289-02</b> 11 12 7 548 921</p> 	<p><b>08-38669-01</b> 11 11 7 548 101</p> 		<p><b>61-35535-00</b> 11 12 7 555 310 83 Ø 1,2 mm MLS</p> <p><b>61-35535-10</b> 11 12 7 555 311 83 Ø 1,5 mm MLS</p> 	<p><b>14-32315-01</b> 11 12 7 548 799</p> 	<p><b>15-37289-01</b> 11 12 7 581 215</p> 	<p><b>12-36866-02</b> 11 34 0 032 582  03/06</p>  <p><b>12-36866-01</b> 11 34 0 034 068  04/06→</p>  <p><b>12-37256-01</b> 11 34 0 035 853</p> 	<p><b>11-37133-01</b>  6x 11 61 7 547 242</p>  <p><b>71-37134-00</b>  6x 18 40 7 530 606</p>  <p><b>71-37136-00</b>   2x 18 10 7 549 447</p> 	<p><b>71-38669-00</b> 11 13 7 548 031</p> 	<p><b>81-34057-00</b>   11 11 7 547 842 65x79 A SL RD PTFE ACM</p>  <p><b>81-37122-00</b>   11 11 7 584 398 90x110 A SL LD PTFE (Polytetrafluorethylen)/ACM (Polyacryl-Kautschuk)</p> 
--	---	--	--	--	--	---	--	---	---	--

BMW

Ltr.  N52 B25 A 155-160 kW (211-218 PS) X3 2.5 i (E83) X3 2.5 si (E83) 08/06-08/10 

















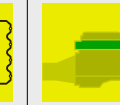
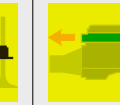
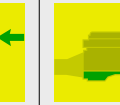



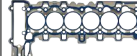





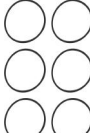









										
	<p><b>02-37289-01</b> 11 12 7 548 921 +11 34 0 035 853 +11 34 0 032 582</p>  <p><b>02-37289-02</b> 11 12 7 548 921</p> 	<p><b>08-38669-01</b> 11 11 7 548 101</p> 		<p><b>61-35535-00</b> 11 12 7 555 310 83 Ø 1,2 mm MLS</p> <p><b>61-35535-10</b> 11 12 7 555 311 83 Ø 1,5 mm MLS</p> 	<p><b>14-32315-01</b> 11 12 7 548 799</p> 	<p><b>15-37159-01</b> 11 12 7 582 245</p> 	<p><b>12-36866-01</b> 11 34 0 034 068</p>  <p><b>12-37256-01</b> 11 34 0 035 853</p> 	<p><b>11-37133-01</b>  </p>  <p><b>71-37134-00</b>  6x 18 40 7 530 606</p> <p><b>71-37136-00</b>   2x 18 10 7 549 447</p>  	<p><b>71-38669-00</b> 11 13 7 548 031</p> 	<p><b>81-34057-00</b> </p>  <p>11 11 7 547 842 65x79 A SL RD PTFE ACM</p> <p><b>81-37122-00</b> </p>  <p>11 11 7 584 398 90x110 A SL LD PTFE (Polytetrafluorethylen)/ACM (Polyacryl-Kautschuk)</p>

2,5 N52 B25 A 160 kW (218 PS) 325 xi (E91) 08/05-08/08













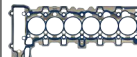

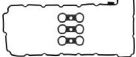







	<p><b>02-37289-01</b> 11 12 7 548 921 +11 34 0 035 853 +11 34 0 032 582</p>  <p><b>02-37289-02</b> 11 12 7 548 921</p> 	<p><b>08-38669-01</b> 11 11 7 548 101</p> 		<p><b>61-35535-00</b> 11 12 7 555 310 83 Ø 1,2 mm MLS</p> <p><b>61-35535-10</b> 11 12 7 555 311 83 Ø 1,5 mm MLS</p> 	<p><b>14-32315-01</b> 11 12 7 548 799</p> 	<p><b>15-37289-01</b> 11 12 7 581 215</p> 	<p><b>12-36866-02</b> 11 34 0 032 582   03/06</p>  <p><b>12-36866-01</b> 11 34 0 034 068</p>  <p><b>12-37256-01</b> 11 34 0 035 853</p> 	<p><b>11-37133-01</b>  </p>  <p><b>71-37134-00</b>  6x 18 40 7 530 606</p> <p><b>71-37136-00</b>   2x 18 10 7 549 447</p>  	<p><b>71-38669-00</b> 11 13 7 548 031</p> 	<p><b>81-34057-00</b> </p>  <p>11 11 7 547 842 65x79 A SL RD PTFE ACM</p> <p><b>81-37122-00</b> </p>  <p>11 11 7 584 398 90x110 A SL LD PTFE (Polytetrafluorethylen)/ACM (Polyacryl-Kautschuk)</p>
--	---	--	--	---	---	---	--	--	---	--

BMW

Ltr.  2,5 N52 B25 AE N52 B25 BE 140 kW (190 PS) 323i (E92) 04/06-02/12 



























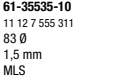
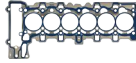

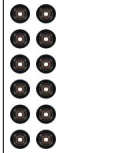
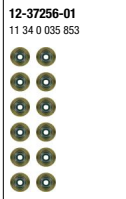
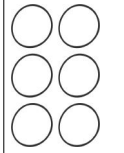















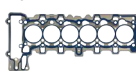

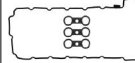
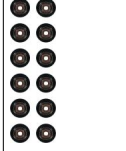
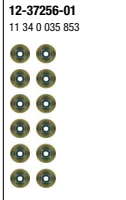
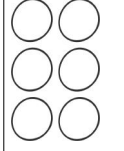
										
	<p><b>02-37159-01</b> 11 12 7 571 963 +11 34 0 035 853</p> 	<p><b>08-38669-01</b> 11 11 7 548 101</p> 		<p><b>61-35535-00</b> 11 12 7 555 310 83 Ø 1,2 mm MLS</p> <p><b>61-35535-10</b> 11 12 7 555 311 83 Ø 1,5 mm MLS</p> 	<p><b>14-32315-01</b> 11 12 7 548 799</p> 	<p><b>15-37159-01</b> 11 12 7 582 245</p> 	<p><b>12-36866-01</b> 11 34 0 034 068</p>  <p><b>12-37256-01</b> 11 34 0 035 853</p> 	<p><b>11-37133-01</b> </p>  <p><b>71-37134-00</b>  6x 18 40 7 530 606</p> 	<p><b>71-38669-00</b> 11 13 7 548 031</p> 	<p><b>81-34057-00</b>  </p>  <p>11 11 7 547 842 65x79 A SL RD PTFE ACM  02/11</p> <p><b>81-10378-00</b>  </p>  <p>11 11 8 618 864 65x79 RD FPM  01/11→</p> <p><b>81-37122-00</b>  </p>  <p>11 11 7 584 398 90x110 A SL LD PTFE (Polytetrafluorethylen)/ACM (Polyacryl-Kautschuk)  12/08</p> <p><b>81-40292-00</b>  </p>  <p>11 11 7 587 168 90x110 A LD FPM  01/09→</p>

2,5 N52 B25 AF N52 B25 B N52 B25 BF 150-155 kW (204-211 PS) Z4 (E89) 325i (E92) 325i xDrive (E92) 523i (F10) 03/09-06/13



	<p><b>02-37159-01</b> 11 12 7 571 963 +11 34 0 035 853</p> 	<p><b>08-38669-01</b> 11 11 7 548 101</p> 		<p><b>61-35535-00</b> 11 12 7 555 310 83 Ø 1,2 mm MLS</p> <p><b>61-35535-10</b> 11 12 7 555 311 83 Ø 1,5 mm MLS</p> 	<p><b>14-32315-01</b> 11 12 7 548 799</p> 	<p><b>15-37159-01</b> 11 12 7 582 245</p> 	<p><b>12-36866-01</b> 11 34 0 034 068</p>  <p><b>12-37256-01</b> 11 34 0 035 853</p> 	<p><b>11-37133-01</b> </p>  <p><b>71-37134-00</b>  6x 18 40 7 530 606</p> 	<p><b>71-38669-00</b> 11 13 7 548 031</p> 	<p><b>81-34057-00</b>  </p>  <p>11 11 7 547 842 65x79 A SL RD PTFE ACM  02/11</p> <p><b>81-10378-00</b>  </p>  <p>11 11 8 618 864 65x79 RD FPM  01/11→</p> <p><b>81-40292-00</b>  </p>  <p>11 11 7 587 168 90x110 A LD FPM</p>
--	---	---	--	---	--	--	--	---	--	--



BMW

Ltr.														
2,5	N52 B25 AF N52 B25 B N52 B25 BF	155-160 kW (211-218 PS)	X3 xDrive 25 i (E83) X3 2.5 i (E83) 325 i (E91)	12/04-12/10	 <b>02-37159-01</b> 11 12 7 571 963 +11 34 0 035 853	 <b>08-38669-01</b> 11 11 7 548 101	 <b>61-35535-00</b> 11 12 7 555 310 83 Ø 1,2 mm MLS   <b>61-35535-10</b> 11 12 7 555 311 83 Ø 1,5 mm MLS	 <b>14-32315-01</b> 11 12 7 548 799	 <b>15-37159-01</b> 11 12 7 582 245	 <b>12-36866-01</b> 11 34 0 034 068   <b>12-37256-01</b> 11 34 0 035 853	 <b>11-37133-01</b>  11 61 7 547 242   <b>71-37134-00</b>  18 40 7 530 606	6x	 <b>71-38669-00</b> 11 13 7 548 031	 <b>81-34057-00</b>  11 11 7 547 842 65x79 A SL RD PTFE ACM   <b>81-37122-00</b>  11 11 7 584 398 90x110 A SL LD PTFE (Polytetrafluorethylen)/ACM (Polyacryl-Kautschuk)   12/08   <b>81-40292-00</b>  11 11 7 587 168 90x110 A LD FPM  01/09 →  
2,5	N52 B25 AF N52 B25 BF	160 kW (218 PS)	X3 2.5 si (E83)	08/06-08/08	 <b>02-37159-01</b> 11 12 7 571 963 +11 34 0 035 853	 <b>08-38669-01</b> 11 11 7 548 101	 <b>61-35535-00</b> 11 12 7 555 310 83 Ø 1,2 mm MLS   <b>61-35535-10</b> 11 12 7 555 311 83 Ø 1,5 mm MLS	 <b>14-32315-01</b> 11 12 7 548 799	 <b>15-37159-01</b> 11 12 7 582 245	 <b>12-36866-01</b> 11 34 0 034 068   <b>12-37256-01</b> 11 34 0 035 853	 <b>11-37133-01</b>  11 61 7 547 242   <b>71-37134-00</b>  18 40 7 530 606	6x	 <b>71-38669-00</b> 11 13 7 548 031	 <b>81-34057-00</b>  11 11 7 547 842 65x79 A SL RD PTFE ACM   <b>81-37122-00</b>  11 11 7 584 398 90x110 A SL LD PTFE (Polytetrafluorethylen)/ACM (Polyacryl-Kautschuk)  

BMW

Ltr.  N53 B25 A 140 kW (190 PS)  523i (E60) 523i (E61)  01/07-12/10

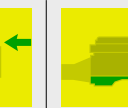
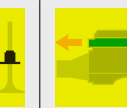
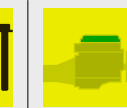

2,5 11 12 7 555 310 83 Ø 1,2 mm MLS

02-39286-01  
11 12 7 561 438



08-38669-01  
11 11 7 548 101



61-35535-00  
11 12 7 555 310  
83 Ø  
1,2 mm  
MLS

61-35535-10  
11 12 7 555 311  
83 Ø  
1,5 mm  
MLS

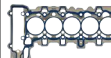

14-32315-01  
11 12 7 548 799



71-39286-00  
11 12 7 544 368

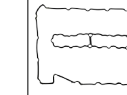

12-36866-01  
11 34 0 034 068

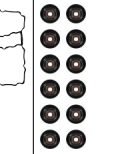

12-37256-01  
11 34 0 035 853

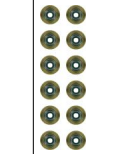

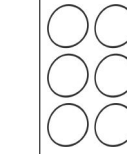

11-37133-01   
11 61 7 547 242



71-37134-00  6x  
18 40 7 530 606



71-37136-00   2x  
18 10 7 549 447



71-38669-00  
11 13 7 548 031



81-34057-00   
11 11 7 547 842  
65x79  
A SL RD PTFE ACM

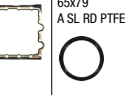

81-37122-00   
11 11 7 584 398  
90x110  
A SL LD PTFE  
(Polytetrafluorethylen)/ACM  
(Polyacryl-Kautschuk)



2,5 S14 B25 (EVO II) 175 kW (238 PS)

02-35080-01  
11 12 1 316 992

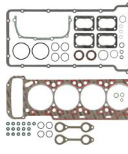

08-19737-05  
11 11 1 316 993

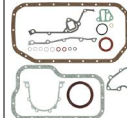

61-35080-00  
11 12 1 316 714  
94,5 Ø  
1,82 mm

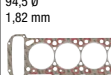

15-35167-01  
11 12 1 312 171  
+11 12 1 312 173 (2x)

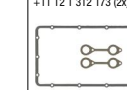

12-26058-03  
11 34 9 059 171 (2x)

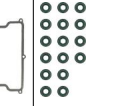

71-27182-10  4x  
11 62 1 312 961



71-19737-20  
11 13 1 727 974

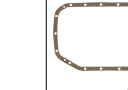

71-25900-10   
11 13 1 727 983

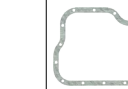

81-28498-00   
11 14 1 435 848  
44x60  
A SL RD FPM

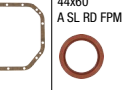

81-20745-40   
11 14 2 245 364  
90x110  
A SL LD FPM

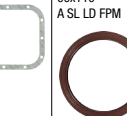

2,5 S14 B25 (254S1) 175 kW (238 PS) M3 EVO II (E30) 01/90-01/92

08-19737-05  
11 11 1 316 993

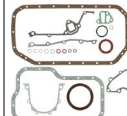

15-35167-01  
11 12 1 312 171  
+11 12 1 312 173 (2x)

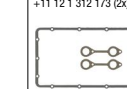

12-26058-03  
11 34 9 059 171 (2x)

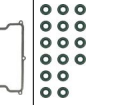

71-27182-10  4x  
11 62 1 312 961



71-19737-20  
11 13 1 727 974

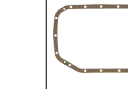

71-25900-10   
11 13 1 727 983

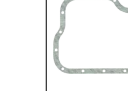

81-28498-00   
11 14 1 435 848  
44x60  
A SL RD FPM

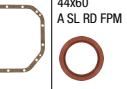

81-20745-40   
11 14 2 245 364  
90x110  
A SL LD FPM

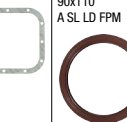

BMW

Ltr. 1

2,7	M20 B27 (Z76EA) M20 B27 (Z76EB) M20 B27 (Z76KA) M20 B27 (Z76KB)	90-95 kW (122-129 PS)	325 e (E30) 525 e (E28)	09/81
-----	--	-----------------------	----------------------------	-------

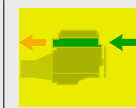

2,7	M20 B27 (Z76EA) M20 B27 (Z76EB) M20 B27 (Z76KA) M20 B27 (Z76KB)	90-95 kW (122-129 PS)	325 e (E30) 525 e (E28)	09/81
-----	--	-----------------------	----------------------------	-------

**02-27035-04**  
11 12 9 059 249  
12/86

**02-27035-05**  
11 12 1 730 885  
01/87→

**08-24600-03**  
11 11 1 730 875

**61-27035-20**  
11 12 1 722 735  
85 Ø  
2,05 mm

**61-27035-30**  
11 12 1 722 734  
85 Ø  
1,75 mm

**14-32001-01**  
11 12 1 726 478

**71-24469-10**  
11 12 1 730 229

**12-26058-01**  
11 34 9 059 172

**70-26058-00**  
11 34 1 288 544

**71-24593-10** 4x  
11 61 1 730 743  
12/86

**71-24594-10** 4x  
11 61 1 730 787  
12/86

**71-27037-10** 4x  
11 61 1 726 010  
01/87→

**71-27038-10** 4x  
11 61 1 726 012  
01/87→

**71-28708-10** 6x  
11 62 1 723 838  
12/86

**71-27122-10** 2x  
11 62 1 728 489  
01/87→

**71-27467-00** 2x  
11 76 1 711 717

**71-24600-20**  
11 13 1 730 234

**81-17404-50**   
11 14 1 265 431  
48x65  
AB SL RD FPM

**81-20745-40**   
11 14 2 245 364  
90x110  
A SL LD FPM

**81-24641-10** **N**  
11 12 1 285 609  
38x50  
A SL FPM

2,8	M30 B28 M30 B28 (528EL) M30 B28 (528TR) M30 B28 (628EL) M30 B28 (728EL) M30 B28 (728TR)	121-135 kW (165-184 PS)	2.8 L (E3) 2800 CS (E9) 2800 (E3) 528 (E12) 528 i (E12) 628 CSI (E24) 728 (E23) 728 i (E23)	10/68
-----	--	-------------------------	--	-------

**02-24195-08**  
11 12 9 065 716

**08-22601-02**  
11 00 1 267 942

**15-22603-02**   
11 14 1 735 047

**61-24195-50**  
11 12 1 730 748  
88 Ø  
2,05 mm

**61-24195-60**  
11 12 1 730 746  
88 Ø  
1,75 mm

**14-32000-02**  
11 12 0 621 144(14x)

**71-22501-20**  
11 12 1 730 935

**12-21025-02**  
11 34 1 256 556 (12x)

**70-21025-00**  
11 34 1 256 556

**71-24887-10** 6x  
11 61 1 730 788

**71-23713-10** 6x  
11 62 1 723 851

**71-22012-20** 2x  
18 11 1 723 843

**71-22601-20**  
11 13 1 315 085



**81-16004-10**   
11 14 1 715 100  
42x62  
A SL RD FPM





















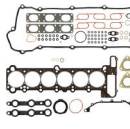





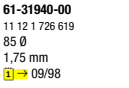

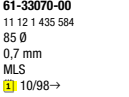
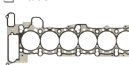
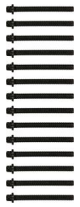

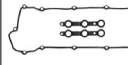
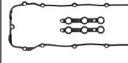
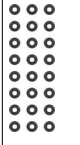









**81-20745-40**   
11 14 2 245 364  
90x110  
A SL LD FPM

BMW



Ltr.															
2,8	M30 B28	126 kW (171 PS)	528 i (E12)	01/75-06/81		<p><b>02-24195-12</b> 11 12 9 065 637</p>	<p><b>08-22601-02</b> 11 00 1 267 942</p>	<p><b>15-22603-02</b> </p> <p>11 14 1 735 047</p>	<p><b>61-24195-50</b> 11 12 1 730 748 88 Ø 2,05 mm</p> <p><b>61-24195-60</b> 11 12 1 730 746 88 Ø 1,75 mm</p>	<p><b>14-32000-02</b> 11 12 0 621 144(14x)</p>	<p><b>71-22501-20</b> 11 12 1 730 935</p>	<p><b>12-25837-03</b> 11 34 9 059 170</p>	<p><b>71-24887-10</b> </p> <p>11 61 1 730 788</p> <p><b>71-23713-10</b> </p> <p>11 62 1 723 851</p> <p><b>71-24648-10</b> </p> <p>11 76 1 266 891</p>	<p><b>71-22601-20</b> 11 13 1 315 085</p>	<p><b>81-16004-10</b> </p> <p>11 14 1 715 100 42x62 A SL RD FPM</p> <p><b>81-20745-40</b> </p> <p>11 14 2 245 364 90x110 A SL LD FPM</p>
2,8	M30 B28 (286EA)	135 kW (184 PS)	528 i (E28)	06/81-12/87		<p><b>02-24195-13</b> 11 12 1 730 769</p>	<p><b>08-22601-02</b> 11 00 1 267 942</p>	<p><b>15-22603-02</b> </p> <p>11 14 1 735 047</p>	<p><b>61-24195-50</b> </p> <p>11 12 1 730 748 88 Ø 2,05 mm</p> <p><b>61-24195-60</b> 11 12 1 730 746 88 Ø 1,75 mm</p>	<p><b>14-32000-02</b> 11 12 0 621 144(14x)</p>	<p><b>71-22501-20</b> </p> <p>11 12 1 730 935  03/82</p> <p><b>71-25221-30</b> 11 12 1 730 231  04/82→</p>	<p><b>12-25837-03</b> 11 34 9 059 170</p>	<p><b>71-24887-10</b> </p> <p>11 61 1 730 788</p> <p><b>71-23713-10</b> </p> <p>11 62 1 723 851</p>	<p><b>71-22601-20</b> 11 13 1 315 085</p>	<p><b>81-16004-10</b> </p> <p>11 14 1 715 100 42x62 A SL RD FPM</p> <p><b>81-20745-40</b> </p> <p>11 14 2 245 364 90x110 A SL LD FPM</p>
2,8	M52 B28 (286S1)	142 kW (193 PS)	328 i (E36)	01/95-04/98		<p><b>02-31940-01</b> 11 12 1 740 984  09/95</p> <p><b>02-31940-02</b> 11 12 1 427 826  10/95→</p>	<p><b>08-27698-03</b> 11 11 1 740 981</p>		<p><b>61-31940-00</b> 11 12 1 726 619 85 Ø 1,75 mm</p> <p><b>61-31940-10</b> 11 12 1 726 622 85 Ø 2,05 mm</p>	<p><b>14-32002-02</b> 11 12 1 721 938</p> <p><b>14-32101-01</b> 11 12 1 740 065</p>	<p><b>15-31036-01</b> 11 12 0 034 107  09/95</p> <p><b>15-31401-01</b> 11 12 0 034 108  10/95→</p> <p><b>71-28940-00</b> </p> <p>11 12 1 740 065</p> <p><b>71-31036-00</b> </p> <p>11 12 0 034 108  10/95→</p> <p><b>71-31401-00</b> </p> <p>11 12 1 740 065  10/95→</p> <p><b>71-31402-00</b> </p> <p>11 12 1 740 065  10/95→</p>	<p><b>12-31306-05</b> 11 34 9 064 457</p> <p><b>70-31306-00</b> 11 34 2 245 151</p>	<p><b>71-31403-00</b> </p> <p>11 61 1 740 069</p> <p><b>71-31404-00</b> </p> <p>11 62 1 744 252</p> <p><b>71-28913-10</b> </p> <p>18 11 1 723 692</p>	<p><b>71-27698-10</b> 11 13 1 437 237</p>	<p><b>81-17404-10</b> </p> <p>11 14 2 249 532 48x65 AB SL RD PTFE (Polytetrafluorethylen)/ACM (Polyacryl-Kautschuk)</p> <p><b>81-17404-50</b> </p> <p>11 14 1 265 431 48x65 AB SL RD FPM</p> <p><b>81-20745-40</b> </p> <p>11 14 2 245 364 90x110 A SL LD FPM</p>

BMW























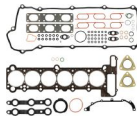







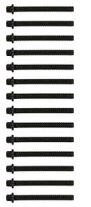

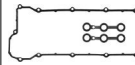
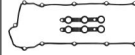
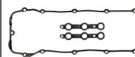

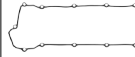

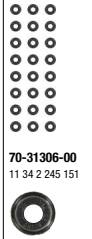







Ltr.     
 2,8 M52 B28 (286S1) 142 kW (193 PS) Z3 2.8 i (E36) 01/98-06/00  
 M52 B28 (286S2) 328i (E46)

										
	<p><b>02-31940-02</b>                  11 12 1 427 826                    11 12 1 436 822                  +11 12 7 501 304                  +11 62 1 732 969 (2x)                    10/98→</p>	<p><b>08-27698-03</b>                  11 11 1 740 981                    11 11 1 432 478                    10/98→</p>	<p><b>15-33097-01</b>                   10/98→  </p>	<p><b>61-31940-00</b>                  11 12 1 726 619                  85 Ø                  1,75 mm                    09/98</p> <p><b>61-31940-10</b>                  11 12 1 726 622                  85 Ø                  2,05 mm                    09/98</p> <p><b>61-33070-00</b>                  11 12 1 435 584                  85 Ø                  0,7 mm                  MLS                    10/98→</p> <p><b>61-33070-10</b>                  11 12 1 435 585                  85 Ø                  1 mm                  MLS                    10/98→</p>	<p><b>14-32002-02</b>                  11 12 1 721 938  </p> <p><b>14-32101-01</b>                  11 12 1 740 065  </p>	<p><b>15-31401-01</b>                  11 12 0 034 108                    09/98</p> <p><b>15-33077-01</b>                  11 12 9 070 990                    10/98→</p>	<p><b>12-31306-05</b>                  11 34 9 064 457                    24x</p> <p><b>70-31306-00</b>                  11 34 2 245 151  </p>	<p><b>11-33074-01</b>                   10/98→                    2x</p> <p><b>71-31403-00</b>                   11 61 1 436 631                    09/98</p> <p><b>71-31404-00</b>                   11 62 1 744 252                    09/98</p> <p><b>71-34834-00</b>                   11 62 1 732 969                    10/98→</p> <p><b>71-28913-10</b>                    18 11 1 723 692  </p>	<p><b>71-27698-10</b>                  11 13 1 437 237  </p>	<p><b>81-17404-10 K</b>                   11 14 2 249 532                  48x65                  AB SL RD PTFE                  (Polytetrafluorethylen)/ACM                  (Polyacryl-Kautschuk)  </p> <p><b>81-17404-50 K</b>                   11 14 1 265 431                  48x65                  AB SL RD FPM  </p> <p><b>81-20745-40 K</b>                   11 14 2 245 364                  90x110                  A SL LD FPM  </p>

BMW

Ltr.   

















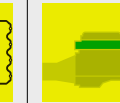
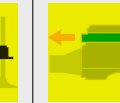
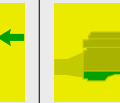
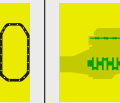
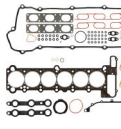







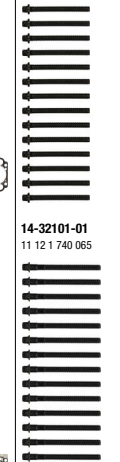
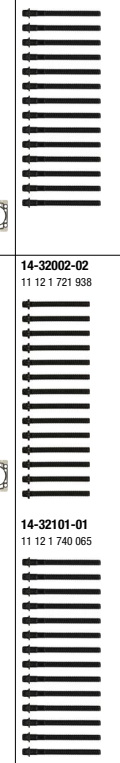
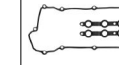
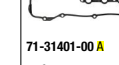

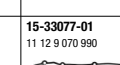
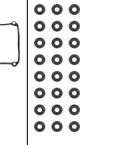



2,8 M52 B28 (286S1) 142 kW (193 PS) 328i (E36) 01/95-11/01  
M52 B28 (286S2) 728i, Li (E38)

										
	<p><b>02-31940-01</b> 11 12 1 740 984 1 → 09/95</p>  <p><b>02-31940-02</b> 11 12 1 427 826 1 → 10/95 → 1 → 09/98</p>  <p><b>02-33070-01</b> 11 12 1 436 822 +11 12 7 501 304 +11 62 1 732 969 (2x) 1 → 10/98 →</p> 	<p><b>08-27698-03</b> 11 11 1 740 981 1 → 09/98</p>  <p><b>08-27698-05</b> 11 11 1 432 478 1 → 10/98 →</p> 	<p><b>15-33097-01</b>  1 → 10/98 →</p> 	<p><b>61-31940-00</b> 11 12 1 726 619 85 Ø 1,75 mm 1 → 09/98</p> <p><b>61-31940-10</b> 11 12 1 726 622 85 Ø 2,05 mm 1 → 09/98</p>  <p><b>61-33070-00</b> 11 12 1 435 584 85 Ø 0,7 mm MLS 1 → 10/98 →</p> <p><b>61-33070-10</b> 11 12 1 435 585 85 Ø 1 mm MLS 1 → 10/98 →</p> 	<p><b>14-32002-02</b> 11 12 1 721 938</p>  <p><b>14-32101-01</b> 11 12 1 740 065</p> 	<p><b>15-31036-01</b> 11 12 0 034 107 1 → 09/95</p>  <p><b>15-31401-01</b> 11 12 0 034 108 1 → 10/95 → 1 → 09/98</p>  <p><b>15-33077-01</b> 11 12 9 070 990 1 → 10/98 →</p>  <p><b>71-28940-00 I</b> 2x 1 → 09/95</p>  <p><b>71-31036-00 A</b> 1 → 09/95</p>  <p><b>71-31401-00 A</b> 1 → 10/95 →</p>  <p><b>71-31402-00 I</b> 2x 1 → 10/95 →</p> 	<p><b>12-31306-05</b> 11 34 9 064 457</p>  <p><b>70-31306-00</b> 24x 11 34 2 245 151</p> 	<p><b>11-33074-01</b>  11 61 1 436 631 1 → 10/98 →</p>  <p><b>71-31403-00</b>  11 61 1 740 069 1 → 09/98</p>  <p><b>71-31404-00</b>  11 62 1 744 252 1 → 09/98</p>  <p><b>71-34834-00</b>  11 62 1 732 969 1 → 10/98 →</p>  <p><b>71-28913-10</b>  18 11 1 723 692</p> 	<p><b>71-27698-10</b> 11 13 1 437 237</p> 	<p><b>81-17404-10 K</b>  11 14 2 249 532 48x65 AB SL RD PTFE (Polytetrafluorethylen)/ACM (Polyacryl-Kautschuk)</p>  <p><b>81-17404-50 K</b>  11 14 1 265 431 48x65 AB SL RD FPM</p>  <p><b>81-20745-40 K</b>  11 14 2 245 364 90x110 A SL LD FPM</p> 

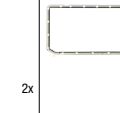













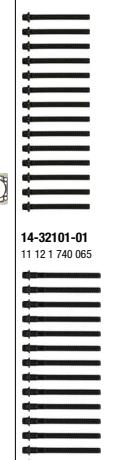
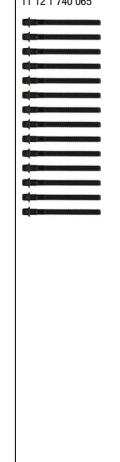



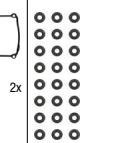

BMW

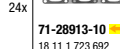
Ltr.   

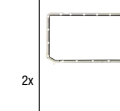
2,8 M52 B28 (286S1) 142-143 kW (193-194 PS) Z3 2.8 (E36) 09/95-08/00  
 M52 B28 (286S2) Z3 2.8 i (E36) 528 i (E39)

										
	<p><b>02-31940-02</b> 11 12 1 427 826 1 → 09/98</p>  <p><b>02-33070-01</b> 11 12 1 436 822 +11 12 7 501 304 +11 62 1 732 969 (2x) 1 → 10/98 →</p> 	<p><b>08-27698-03</b> 11 11 1 740 981 1 → 09/98</p>  <p><b>08-27698-05</b> 11 11 1 432 478 1 → 10/98 →</p> 	<p><b>15-33097-01</b>  1 → 10/98 →</p>  <p><b>61-31940-00</b> 11 12 1 726 619 85 Ø 1,75 mm 1 → 09/98</p> <p><b>61-31940-10</b> 11 12 1 726 622 85 Ø 2,05 mm 1 → 09/98</p>  <p><b>61-33070-00</b> 11 12 1 435 584 85 Ø 0,7 mm MLS 1 → 10/98 →</p> <p><b>61-33070-10</b> 11 12 1 435 585 85 Ø 1 mm MLS 1 → 10/98 →</p> 	<p><b>14-32002-02</b> 11 12 1 721 938</p>  <p><b>14-32101-01</b> 11 12 1 740 065</p> 	<p><b>15-31401-01</b> 11 12 0 034 108 1 → 09/98</p>  <p><b>15-33077-01</b> 11 12 9 070 990 1 → 10/98 →</p>  <p><b>71-31401-00 A</b></p>  <p><b>71-31402-00 I</b> 2x</p> 	<p><b>12-31306-05</b> 11 34 9 064 457</p>  <p><b>70-31306-00</b> 24x 11 34 2 245 151</p> 	<p><b>11-33074-01 I</b>  11 61 1 436 631 1 → 10/98 →</p>  <p><b>71-31403-00 I</b> 2x 11 61 1 740 069 1 → 09/98</p>  <p><b>71-31404-00</b> 2x 11 62 1 744 252 1 → 09/98</p>  <p><b>71-34834-00</b> 2x 11 62 1 732 969 1 → 10/98 →</p>  <p><b>71-28913-10</b>  16 2x 18 11 1 723 692</p> 	<p><b>71-27698-10</b> 11 13 1 437 237</p> 	<p><b>81-17404-10 K</b>  11 14 2 249 532 48x65 AB SL RD PTFE (Polytetrafluorethylen)/ACM (Polyacryl-Kautschuk)</p>  <p><b>81-17404-50 K</b>  11 14 1 265 431 48x65 AB SL RD FPM</p>  <p><b>81-20745-40 K</b>  11 14 2 245 364 90x110 A SL LD FPM</p> 	

















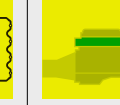
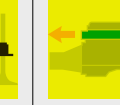
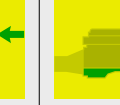



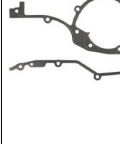

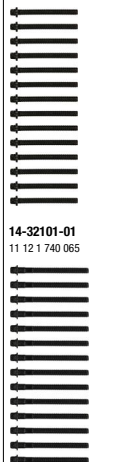
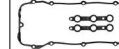





2,8 M52 B28 (286S2) 142 kW (193 PS) 328 Ci (E46) 12/98-05/00

	<p><b>02-33070-01</b> 11 12 1 436 822 +11 12 7 501 304 +11 62 1 732 969 (2x)</p> 	<p><b>08-27698-05</b> 11 11 1 432 478</p> 	<p><b>15-33097-01</b>  1 → 10/98 →</p>  <p><b>61-33070-00</b> 11 12 1 435 584 85 Ø 0,7 mm MLS</p> <p><b>61-33070-10</b> 11 12 1 435 585 85 Ø 1 mm MLS</p> 	<p><b>14-32002-02</b> 11 12 1 721 938</p>  <p><b>14-32101-01</b> 11 12 1 740 065</p> 	<p><b>15-33077-01</b> 11 12 9 070 990</p>  <p><b>71-31402-00 I</b> 2x</p>  <p><b>71-33077-00</b></p> 	<p><b>12-31306-05</b> 11 34 9 064 457</p>  <p><b>70-31306-00</b> 24x 11 34 2 245 151</p> 	<p><b>11-33074-01 I</b>  11 61 1 436 631</p>  <p><b>71-34834-00</b> 2x 11 62 1 732 969</p>  <p><b>71-28913-10</b>  16 2x 18 11 1 723 692</p> 	<p><b>71-27698-10</b> 11 13 1 437 237</p> 	<p><b>81-17404-10 K</b>  11 14 2 249 532 48x65 AB SL RD PTFE (Polytetrafluorethylen)/ACM (Polyacryl-Kautschuk)</p>  <p><b>81-17404-50 K</b>  11 14 1 265 431 48x65 AB SL RD FPM</p>  <p><b>81-20745-40 K</b>  11 14 2 245 364 90x110 A SL LD FPM</p> 
--	--	--	---	--	---	--	---	---	--















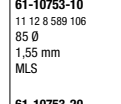
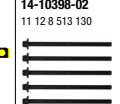
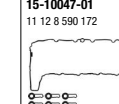
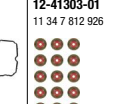
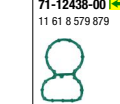



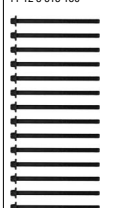

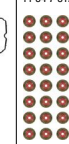
BMW

Ltr.   















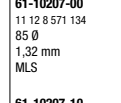
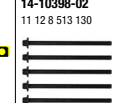
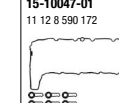
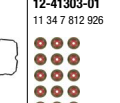
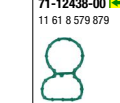

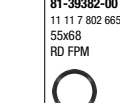

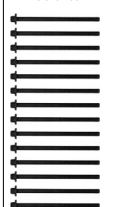
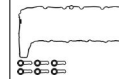
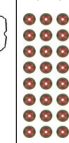
2,8 M52 B28 (286S2) 142 kW (193 PS) 328i (E46) 06/99-05/00

										
	<p><b>02-33070-01</b> 11 12 1 436 822 +11 12 7 501 304 +11 62 1 732 969 (2x)</p> 	<p><b>08-27698-05</b> 11 11 1 432 478</p> 	<p><b>15-33097-01</b> </p> 	<p><b>61-33070-00</b> 11 12 1 435 584 85 Ø 0,7 mm MLS</p> <p><b>61-33070-10</b> 11 12 1 435 585 85 Ø 1 mm MLS</p> 	<p><b>14-32002-02</b> 11 12 1 721 938</p> 	<p><b>15-33077-01</b> 11 12 9 070 990</p> 	<p><b>12-31306-05</b> 11 34 9 064 457</p>  <p><b>70-31306-00</b> 11 34 2 245 151</p> 	<p><b>11-33074-01</b> </p> <p>11 61 1 436 631</p>  <p><b>71-34834-00</b>  2x</p>  <p><b>71-28913-10</b>   2x</p> <p>11 62 1 732 969</p> 	<p><b>71-27698-10</b> 11 13 1 437 237</p> 	<p><b>81-17404-10</b> </p> <p>11 14 2 249 532 48x65 AB SL RD PTFE (Polytetrafluorethylen)/ACM (Polyacryl-Kautschuk)</p>  <p><b>81-17404-50</b> </p> <p>11 14 1 265 431 48x65 AB SL RD FPM</p>  <p><b>81-20745-40</b> </p> <p>11 14 2 245 364 90x110 A SL LD FPM</p> 

3,0 B57 D30 A 155-195 kW (211-265 PS) X6 xDrive 30 d (G06, F96) 03/19  
330 d (G20, G80)  
330 d (G21, G81)

										
	<p><b>02-10207-01</b></p> 			<p><b>61-10753-10</b> 11 12 8 589 106 85 Ø 1,55 mm MLS</p> <p><b>61-10753-20</b> 11 12 8 589 107 85 Ø 1,65 mm MLS</p> 	<p><b>14-10398-02</b> 11 12 8 513 130</p> 	<p><b>15-10047-01</b> 11 12 8 590 172</p> 	<p><b>12-41303-01</b> 11 34 7 812 926</p> 	<p><b>71-12438-00</b> </p> <p>11 61 8 579 879</p>  <p><b>71-39421-10</b>  3x</p> 	<p><b>70-31414-10</b></p> 	<p><b>81-39382-00</b> </p> <p>11 11 7 802 665 55x68 RD FPM</p>  <p><b>81-39379-00</b> </p> <p>11 14 7 797 490 90x104 LD FPM</p> 

3,0 B57 D30 A 155-235 kW (211-320 PS) X3 xDrive 30 d (G01) 07/15  
X3 xDrive 30 d (G01, F97)  
X5 xDrive 30 d (G05)  
330 d (G21)  
330 d xDrive (G21)  
530 d (G31)  
530 d xDrive (G30, F90)  
530 d xDrive (G31)  
540 d xDrive (G30, F90)  
630 d (G32)  
630 d xDrive (G32)  
730 d (G11, G12)  
730 d, Ld xDrive (G11, G12)  
730 d xDrive (G11, G12)

										
	<p><b>02-10207-01</b></p> 			<p><b>61-10207-00</b> 11 12 8 571 134 85 Ø 1,32 mm MLS</p> <p><b>61-10207-10</b> 11 12 8 571 135 85 Ø 1,42 mm MLS</p> <p><b>61-10207-20</b> 11 12 8 571 136 85 Ø 1,52 mm MLS</p> 	<p><b>14-10398-02</b> 11 12 8 513 130</p> 	<p><b>15-10047-01</b> 11 12 8 590 172</p> 	<p><b>12-41303-01</b> 11 34 7 812 926</p> 	<p><b>71-12438-00</b> </p> <p>11 61 8 579 879</p>  <p><b>71-39421-10</b>  3x</p> 	<p><b>70-31414-10</b></p> 	<p><b>81-39382-00</b> </p> <p>11 11 7 802 665 55x68 RD FPM</p>  <p><b>81-39379-00</b> </p> <p>11 14 7 797 490 90x104 LD FPM</p> 



BMW

Ltr.														
3,0	B57 D30 A	183-195 kW (249-265 PS)	X4 xDrive 30 d (G02, F98) 04/18-06/20											
					02-10207-01				14-10398-02 11 12 8 513 130	15-10047-01 11 12 8 590 172	12-41303-01 11 34 7 812 926	71-12438-00  6x 11 61 8 579 879	70-31414-10	81-39382-00 11 11 7 802 665 55x68 RD FPM
												71-39421-10  3x 11 62 8 509 783		81-39379-00 11 14 7 797 490 90x104 LD FPM
3,0	B57 D30 A	183-195 kW (249-265 PS)	X5 xDrive 30 d (G05, F95) 08/18 X7 xDrive 30 d (G07)											
									14-10398-02 11 12 8 513 130	15-10047-01 11 12 8 590 172	12-41303-01 11 34 7 812 926	71-12438-00  6x 11 61 8 579 879	70-31414-10	81-39382-00 11 11 7 802 665 55x68 RD FPM
												71-39421-10  3x 11 62 8 509 783		81-39379-00 11 14 7 797 490 90x104 LD FPM
3,0	B57 D30 A	195 kW (265 PS)	530 d (G30) 530 d xDrive (G30) 09/16-06/20		02-10207-01									
					02-10207-01									
3,0	B57 D30 B	210-250 kW (286-340 PS)	X3 xDrive 30 d Mild-Hybrid (G01, F97) X4 xDrive 30 d Mild-Hybrid (G02, F98) X5 xDrive 30 d Mild-Hybrid (G05, F95) X6 xDrive 30 d Mild-Hybrid (G06, F96) X7 xDrive 40 d Mild-Hybrid (G07) 330 d xDrive Mild-Hybrid (G21, G21) 530 d Mild-Hybrid (G31) 530 d xDrive Mild-Hybrid (G30, F90) 530 d xDrive Mild-Hybrid (G31) 03/19 <b>[NEW]</b>											
									14-10398-02 11 12 8 513 130		12-41303-01 11 34 7 812 926	71-12482-00  2x 11 62 8 506 402	70-31414-10	81-39382-00 11 11 7 802 665 55x68 RD FPM
												71-15479-00 11 65 8 598 180		81-10659-00 11 14 8 599 771 90x104 AB LD FPM



































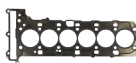

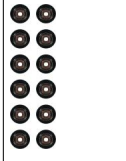
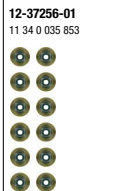







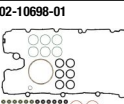

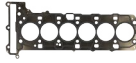



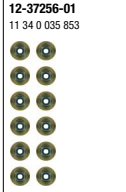













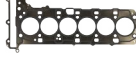

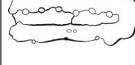
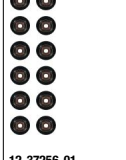
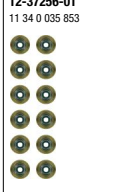
BMW

Ltr.	Motor	Power (kW/PS)	Model	Year	Image 1	Image 2	Image 3	Image 4	Image 5	Image 6	Image 7	Image 8	Image 9	Image 10	Image 11	Image 12
3,0	B57 D30 B	235-250 kW (320-340 PS)	M 340 d xDrive Mild-Hybrid (G20, G80) M 340 d xDrive Mild-Hybrid (G21, G81) X3 xDrive M40 d (G01, F97) X4 M40 d xDrive (G02, F98) X5 xDrive 40 d Mild-Hybrid (G05, F95) 540 d xDrive (G30, F90) 540 d xDrive (G31) 640 d xDrive (G32) 740 d, Ld xDrive (G11, G12) 840 d xDrive (G16, F93)	11/15												
								<p><b>61-10753-10</b> 11 12 8 589 106 85 Ø 1,55 mm MLS </p> <p><b>61-10753-20</b> 11 12 8 589 107 85 Ø 1,65 mm MLS </p>	<p><b>14-10398-02</b> 11 12 8 513 130</p>	<p><b>15-10047-01</b> 11 12 8 590 172</p>	<p><b>12-41303-01</b> 11 34 7 812 926</p>	<p><b>71-12438-00</b>  11 61 8 579 879</p> <p><b>71-12482-00</b>  11 62 8 506 402</p>	<p><b>70-31414-10</b></p>	<p><b>81-39382-00</b>  11 11 7 802 665 55x68 RD FPM</p> <p><b>81-39379-00</b>  11 14 7 797 490 90x104 LD FPM</p>		
3,0	B57 D30 C	294 kW (400 PS)	M 550 d xDrive (G30, F90) 07/16 M 550 d xDrive (G31) X6 xDrive M50 d (G06, F96) 750 d, Ld xDrive (G11, G12)			<b>02-11111-01</b>	<b>08-11111-01</b>	<p><b>61-11111-00</b> 11 12 8 593 207 85 Ø 1,45 mm MLS </p> <p><b>61-11111-10</b> 11 12 8 593 208 85 Ø 1,55 mm MLS </p> <p><b>61-11111-20</b> 11 12 8 593 209 85 Ø 1,65 mm MLS </p>	<p><b>14-10017-01</b> 11 12 8 570 942</p>	<p><b>15-10047-01</b> 11 12 8 590 172</p>	<p><b>12-41303-01</b> 11 34 7 812 926</p>	<p><b>71-41231-00</b>  11 61 7 807 480</p> <p><b>71-12482-00</b>  11 62 8 506 402</p>	<p><b>71-17436-00</b> 11 13 8 575 780</p>	<p><b>81-39382-00</b>  11 11 7 802 665 55x68 RD FPM</p> <p><b>81-39379-00</b>  11 14 7 797 490 90x104 LD FPM</p>		
3,0	B57 D30 C	294 kW (400 PS)	X5 xDrive M50 d (G05, F95) X7 xDrive M50 d (G07)	08/18		<b>02-11111-01</b>	<b>08-11111-01</b>	<p><b>61-11111-00</b> 11 12 8 593 207 85 Ø 1,45 mm MLS </p> <p><b>61-11111-10</b> 11 12 8 593 208 85 Ø 1,55 mm MLS </p> <p><b>61-11111-20</b> 11 12 8 593 209 85 Ø 1,65 mm MLS </p>	<p><b>14-10017-01</b> 11 12 8 570 942</p>	<p><b>15-10047-01</b> 11 12 8 590 172</p>						

BMW

Ltr.														
3,0	B58 B30 A	240-265 kW (326-360 PS)	07/15	M 140 i (F20) M 140 i (F21) M 140 i xDrive (F20) M 140 i xDrive (F21) M 240 i (F22, F87) M 240 i (F23) M 240 i xDrive (F22, F87) M 240 i xDrive (F23) X3 xDrive M40 i (G01) X3 xDrive M40 i (G01, F97) X4 M40 i xDrive (G02, F98) 340 i (F30, F35, F80) 340 i (F30, F80) 340 i (F31) 340 i (F34) 340 i xDrive (F30, F80) 340 i xDrive (F31) 340 i xDrive (F34) 440 i (F32, F82) 440 i (F33, F83) 440 i (F36) 440 i xDrive (F32, F82) 440 i xDrive (F33, F83) 440 i xDrive (F36) 540 i (G30) 540 i xDrive (G30) 540 i xDrive (G31) 740 i (G11, G12) 740 i, Li xDrive (G11, G12)				 <b>61-10215-00</b> 11 12 8 654 268 83 Ø 0,7 mm MLS  <b>61-10215-10</b> 11 12 8 654 269 83 Ø 1 mm MLS	 <b>14-12261-03</b> 11 12 8 644 674	 <b>15-12480-01</b> 11 12 8 621 951 +11 12 8 638 124	 <b>12-36866-01</b> 11 34 0 034 068  <b>12-37256-01</b> 11 34 0 035 853	 <b>71-12439-00</b> 6x 11 61 8 637 800  <b>71-12484-00</b> 11 65 7 643 149	 <b>70-31414-10</b>	 <b>81-37002-00</b> 11 11 8 604 931 55x68 AB RD PTFE   <b>81-10448-00</b> 11 14 8 602 594 90x104 LD PTFE ACM
3,0	B58 B30 A	250-265 kW (340-360 PS)	09/16-06/20	540 i (G30) 640 i (G32) 640 i xDrive (G32)			 <b>61-10215-00</b> 11 12 8 654 268 83 Ø 0,7 mm MLS  <b>61-10215-10</b> 11 12 8 654 269 83 Ø 1 mm MLS	 <b>14-12261-03</b> 11 12 8 644 674	 <b>12-36866-01</b> 11 34 0 034 068  <b>12-37256-01</b> 11 34 0 035 853	 <b>71-12439-00</b> 6x 11 61 8 637 800  <b>71-12484-00</b> 11 65 7 643 149	 <b>70-31414-10</b>	 <b>81-37002-00</b> 11 11 8 604 931 55x68 AB RD PTFE   <b>81-10448-00</b> 11 14 8 602 594 90x104 LD PTFE ACM		
3,0	B58 B30 A	260 kW (354 PS)	04/18-08/19	X3 xDrive M40 i (G01, F97) X4 M40 i xDrive (G02, F98)										

BMW

Ltr.															
3,0	B58 B30 B B58 B30 C	190-285 kW (258-387 PS)	M 240 i xDrive (G42, G87) M 340 i xDrive (G20, G80) M 340 i xDrive (G21) M 340 i xDrive (G21, G81) M 340 i xDrive Mild-Hybrid (G20, G80, G28) M 340 i xDrive Mild-Hybrid (G21, G81) M 440 i Mild-Hybrid (G22, G82) M 440 i Mild-Hybrid (G23, G83) M 440 i xDrive Mild-Hybrid (G22, G82) M 440 i xDrive Mild-Hybrid (G23, G83) M40 i xDrive (G02, F98) X3 xDrive M40 i (G01) X3 xDrive M40 i (G01, F97) 630 i xDrive (G32) 640 i Mild-Hybrid (G32) 640 i xDrive Mild-Hybrid (G32)	03/19											
								<b>61-10844-00</b> 11 12 7 934 583 82,5 Ø 0,81 mm MLS  <b>61-10844-10</b> 11 12 7 934 584 82,5 Ø 1,11 mm MLS 	<b>14-12261-03</b> 11 12 8 644 674 	<b>15-11205-01</b> 11 12 9 894 803 	<b>12-36866-01</b> 11 34 0 034 068   <b>12-37256-01</b> 11 34 0 035 853 	<b>71-17375-00</b>  6x 11 61 9 486 362 	<b>70-31414-10</b> 	<b>81-37002-00</b>  11 11 8 604 931 55x68 AB RD PTFE   <b>81-10448-00</b>  11 14 8 602 594 90x104 LD PTFE ACM 	
3,0	B58 B30 C	235-250 kW (320-340 PS)	X5 xDrive 40 i (G05) X5 xDrive 40 i Mild-Hybrid (G05, F95) X5 xDrive 45e Plug-in-Hybrid (G05, F95) X6 xDrive 40 i (G06, F96) X6 xDrive 40 i Mild-Hybrid (G06, F96) X7 xDrive 40 i Mild-Hybrid (G07) 740 i, Li (G11, G12) 740 Li xDrive (G11, G12) 840 i (G14, F91) 840 i (G15, F92) 840 i (G16, F93) 840 i xDrive (G14, F91) 840 i xDrive (G15, F92) 840 i xDrive (G16, F93)	03/19					<b>61-10844-00</b> 11 12 7 934 583 82,5 Ø 0,81 mm MLS  <b>61-10844-10</b> 11 12 7 934 584 82,5 Ø 1,11 mm MLS 	<b>14-12261-03</b> 11 12 8 644 674 	<b>15-11205-01</b> 11 12 9 894 803 	<b>12-36866-01</b> 11 34 0 034 068   <b>12-37256-01</b> 11 34 0 035 853 	<b>71-17375-00</b>  6x 11 61 9 486 362   <b>71-17379-00</b>  2x 11 65 8 669 732 	<b>70-31414-10</b> 	<b>81-37002-00</b>  11 11 8 604 931 55x68 AB RD PTFE   <b>81-10448-00</b>  11 14 8 602 594 90x104 LD PTFE ACM 
3,0	B58 B30 C	245-290 kW (333-394 PS)	X5 xDrive 40 i (G05, F95) X5 xDrive 45e Plug-in-Hybrid (G05, F95) X7 xDrive 40 i (G07) Z4 M40 i (G29) 540 i xDrive Mild-Hybrid (G31) 740 i, Li (G11, G12) 740 Li xDrive (G11, G12) 745 e, Le (G11, G12) 745 Le xDrive (G11, G12)	08/18					<b>61-10844-00</b> 11 12 7 934 583 82,5 Ø 0,81 mm MLS  <b>61-10844-10</b> 11 12 7 934 584 82,5 Ø 1,11 mm MLS 	<b>14-12261-03</b> 11 12 8 644 674 	<b>15-11205-01</b> 11 12 9 894 803 	<b>12-36866-01</b> 11 34 0 034 068   <b>12-37256-01</b> 11 34 0 035 853 	<b>71-17375-00</b>  6x 11 61 9 486 362   <b>71-17379-00</b>  2x 11 65 8 669 732 	<b>70-31414-10</b> 	<b>81-37002-00</b>  11 11 8 604 931 55x68 AB RD PTFE   <b>81-10448-00</b>  11 14 8 602 594 90x104 LD PTFE ACM 

























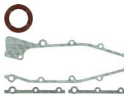



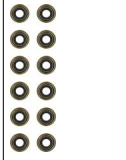













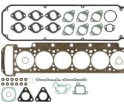

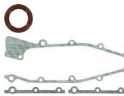

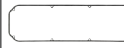
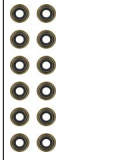
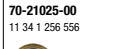















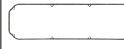
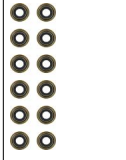
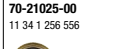











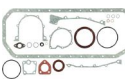



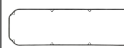
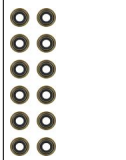
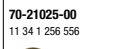

BMW

Ltr.														
3,0	B58 B30 C	250-265 kW (340-360 PS)	540 i (G30) 640 i (G32) 640 i xDrive (G32)	09/16-06/20										
3,0	M30 B30	131 kW (178 PS)	530 i (E12)	09/74-12/78										
3,0	M30 B30	131-136 kW (178-185 PS)	630 CS (E24) 630 CSI (E24) 730 (E23)	04/76-08/79										









































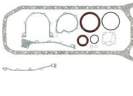



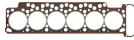
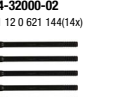

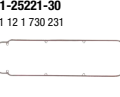

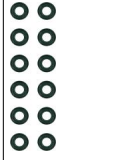













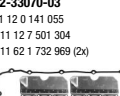









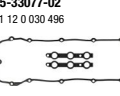

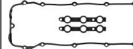





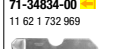

















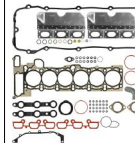

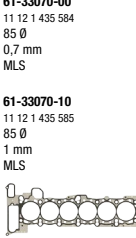

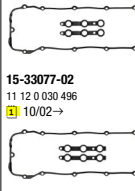
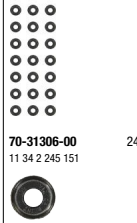
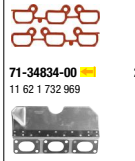

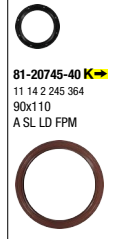

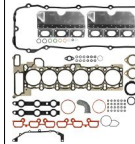
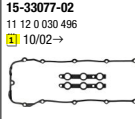
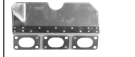

BMW

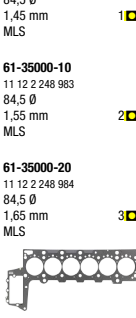
Ltr.															
3,0	M30 B30	132 kW (180 PS)	2500-3.3 (E3) - 3.0 L 2500-3.3 (E3) - 3.0 S	05/71-04/77			<b>08-22601-02</b> 11 00 1 267 942 	<b>15-22603-02</b>  11 14 1 735 047 	<b>61-24200-50</b> 11 12 9 065 638 90 Ø 1,75 mm 	<b>14-32000-02</b> 11 12 0 621 144(14x) 	<b>71-22501-20</b> 11 12 1 730 935 	<b>12-21025-02</b> 11 34 1 256 556 (12x)  01/76→  <b>70-21025-00</b> 11 34 1 256 556  01/76→ 	<b>71-24887-10</b>  11 61 1 730 788  <b>71-22012-20</b>  18 11 1 723 843  <b>71-23713-10</b>  11 62 1 723 851 	<b>71-22601-20</b> 11 13 1 315 085 	<b>81-16004-10</b>  11 14 1 715 100 42x62 A SL RD FPM  <b>81-20745-40</b>  11 14 2 245 364 90x110 A SL LD FPM 
3,0	M30 B30	132 kW (180 PS)	3.0 CS (E9)	05/71-03/76	<b>02-24200-11</b> 11 12 9 065 705 	<b>08-22601-02</b> 11 00 1 267 942 	<b>15-22603-02</b>  11 14 1 735 047 	<b>61-24200-50</b> 11 12 9 065 638 90 Ø 1,75 mm 	<b>14-32000-02</b> 11 12 0 621 144(14x) 	<b>71-22501-20</b> 11 12 1 730 935 	<b>12-21025-02</b> 11 34 1 256 556 (12x)  <b>70-21025-00</b> 11 34 1 256 556 	<b>71-24887-10</b>  11 61 1 730 788  <b>71-22012-20</b>  18 11 1 723 843  <b>71-23713-10</b>  11 62 1 723 851 	<b>71-22601-20</b> 11 13 1 315 085 	<b>81-16004-10</b>  11 14 1 715 100 42x62 A SL RD FPM  <b>81-20745-40</b>  11 14 2 245 364 90x110 A SL LD FPM 	
3,0	M30 B30	143 kW (194 PS)	3.0 Si (E3)	10/75-04/77		<b>08-22601-02</b> 11 00 1 267 942 	<b>15-22603-02</b>  11 14 1 735 047 	<b>61-24200-50</b> 11 12 9 065 638 90 Ø 1,75 mm 		<b>71-22501-20</b> 11 12 1 730 935 	<b>12-21025-02</b> 11 34 1 256 556 (12x)  <b>70-21025-00</b> 11 34 1 256 556 	<b>71-24887-10</b>  11 61 1 730 788  <b>71-22012-20</b>  18 11 1 723 843  <b>71-23713-10</b>  11 62 1 723 851 	<b>71-22601-20</b> 11 13 1 315 085 	<b>81-16004-10</b>  11 14 1 715 100 42x62 A SL RD FPM  <b>81-20745-40</b>  11 14 2 245 364 90x110 A SL LD FPM 	
3,0	M30 B30	147 kW (200 PS)	3.0 Csi (E9)	07/71-03/76	<b>02-24200-13</b> 11 12 9 065 720 	<b>08-22601-02</b> 11 00 1 267 942 	<b>15-22603-02</b>  11 14 1 735 047 	<b>61-24200-50</b> 11 12 9 065 638 90 Ø 1,75 mm 		<b>71-22501-20</b> 11 12 1 730 935 	<b>12-21025-02</b> 11 34 1 256 556 (12x)  <b>70-21025-00</b> 11 34 1 256 556 	<b>71-24887-10</b>  11 61 1 730 788  <b>71-22012-20</b>  18 11 1 723 843  <b>71-23713-10</b>  11 62 1 723 851 	<b>71-22601-20</b> 11 13 1 315 085 	<b>81-16004-10</b>  11 14 1 715 100 42x62 A SL RD FPM  <b>81-20745-40</b>  11 14 2 245 364 90x110 A SL LD FPM 	

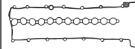
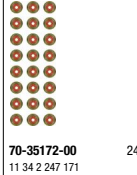
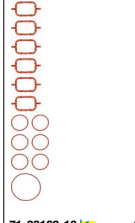
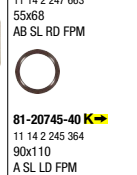
BMW

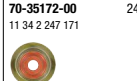

































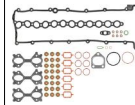





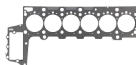
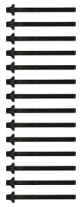
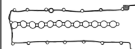
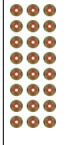













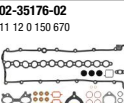

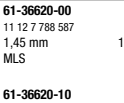
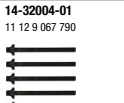
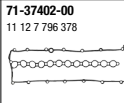



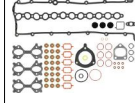







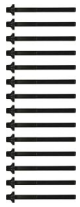
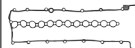
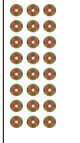



<p>Ltr.  M30 B30</p> <p>147 kW (200 PS)</p> <p>3.0 Si (E3)</p> <p>07/71-09/75</p>			 <p><b>08-22601-02</b> 11 00 1 267 942</p> 	 <p><b>15-22603-02</b> </p> <p>11 14 1 735 047</p> 	 <p><b>61-24200-50</b> 11 12 9 065 638 90 Ø 1,75 mm</p> 	 <p><b>14-32000-02</b> 11 12 0 621 144(14x)</p> 	 <p><b>71-22501-20</b> 11 12 1 730 935</p> 		 <p><b>71-24887-10</b>  6x 11 61 1 730 788</p>  <p><b>71-22012-20</b> 2x 18 11 1 723 843</p>  <p><b>71-23713-10</b> 6x 11 62 1 723 851</p> 	 <p><b>71-22601-20</b> 11 13 1 315 085</p> 	 <p><b>81-16004-10</b> </p> <p>11 14 1 715 100 42x62 A SL RD FPM</p>  <p><b>81-20745-40</b> </p> <p>11 14 2 245 364 90x110 A SL LD FPM</p> 
<p>3,0 M30 B30 (306EA) M30 B30 (306KA)</p> <p>138-145 kW (188-197 PS)</p> <p>530 i (E34) 730 i, Li (E32)</p> <p>03/85-03/94</p>		 <p><b>02-27490-02</b> 11 12 9 059 237</p> 	 <p><b>08-27468-02</b> 11 00 9 058 775</p> 	 <p><b>15-22603-02</b> </p> <p>11 14 1 735 047</p> 	 <p><b>61-27490-10</b> 11 12 1 730 217 90 Ø 1,7 mm</p> 	 <p><b>14-32000-02</b> 11 12 0 621 144(14x)</p> 	 <p><b>71-25221-30</b> 11 12 1 730 231</p> 	 <p><b>12-25837-03</b> 11 34 9 059 170</p>  <p><b>70-25837-00</b> 12x 11 34 1 273 501</p> 	 <p><b>71-24887-10</b>  6x 11 61 1 730 788</p>  <p><b>71-27121-10</b> 2x 11 62 1 723 656</p> 	 <p><b>71-27468-10</b> 11 13 1 722 695</p> 	 <p><b>81-16004-10</b> </p> <p>11 14 1 715 100 42x62 A SL RD FPM</p>  <p><b>81-20745-40</b> </p> <p>11 14 2 245 364 90x110 A SL LD FPM</p> 
<p>3,0 M54 B30 (306S3)</p> <p>168-170 kW (228-231 PS)</p> <p>X3 3.0 i (E83) Z4 3.0 i (E85) 330 xi (E46) 530 i (E60) 730 i, Li (E65, E66)</p> <p>12/01-07/08</p>	 <p><b>02-33070-03</b> 11 12 0 141 055 +11 12 7 501 304 +11 62 1 732 969 (2x)</p> 	 <p><b>08-27698-05</b> 11 11 1 432 478</p> 	 <p><b>61-33070-00</b> 11 12 1 435 584 85 Ø 0,7 mm MLS</p> <p><b>61-33070-10</b> 11 12 1 435 585 85 Ø 1 mm MLS</p> 	 <p><b>14-32101-01</b> 11 12 1 740 065</p> 	 <p><b>15-33077-02</b> 11 12 0 030 496</p> 	 <p><b>12-31306-05</b> 11 34 9 064 457</p>  <p><b>70-31306-00</b> 24x 11 34 2 245 151</p> 	 <p><b>11-33074-01</b>  2x 11 61 1 436 631</p>  <p><b>71-34834-00</b> 2x 11 62 1 732 969</p> 	 <p><b>71-27698-10</b> 11 13 1 437 237</p> 	 <p><b>81-17404-10</b> </p> <p>11 14 2 249 532 48x65 AB SL RD PTFE (Polytetrafluorethylen)/ACM (Polyacryl-Kautschuk)</p>  <p><b>81-20745-40</b> </p> <p>11 14 2 245 364 90x110 A SL LD FPM</p> 		

BMW

Ltr.														
3,0	M54 B30 (306S3)	170 kW (231 PS)	04/00-10/06	 02-33070-02 11 12 7 507 597 +11 12 7 501 304 +11 62 1 732 969 (2x) 10/02	 08-27698-05 11 11 1 432 478	 61-33070-00 11 12 1 435 584 85 Ø 0,7 mm MLS	 14-32101-01 11 12 1 740 065	 15-33077-01 11 12 9 070 990 10/02	 12-31306-05 11 34 9 064 457	 11-33074-01 11 61 1 436 631	 71-27698-10 11 13 1 437 237	 81-17404-K 11 14 2 249 532 48x65 AB SL RD PTFE (Polytetrafluorethylen)/ACM (Polyacryl-Kautschuk)	 81-20745-40-K 11 14 2 245 364 90x110 A SL LD FPM	
				 02-33070-03 11 12 0 141 055 +11 12 7 501 304 +11 62 1 732 969 (2x) 10/02					 15-33077-02 11 12 0 030 496 10/02		 71-34834-00 11 62 1 732 969			
3,0	M57 D30 (306D1)	135 kW (184 PS)	08/98-09/00	 02-35176-01 11 12 2 248 985	 08-37313-01 11 11 2 248 975	 04-10029-01 10/99	 61-35000-00 11 12 2 248 982 84,5 Ø 1,45 mm MLS	 14-32004-01 11 12 9 067 790	 71-37402-00 11 12 7 796 378	 12-35172-02 11 34 9 071 732	 11-77546-01 11 61 2 246 586	 81-35723-00-K 11 14 2 247 663 55x68 AB SL RD FPM	 81-20745-40-K 11 14 2 245 364 90x110 A SL LD FPM	
							 61-35000-10 11 12 2 248 983 84,5 Ø 1,55 mm MLS			 71-35172-00 11 34 2 247 171	 71-33109-10 11 61 2 246 944	 71-77546-00 11 61 2 246 945	 71-33027-00 11 62 7 796 480	



BMW

Ltr.														
3,0	M57 D30 (306D1)	135-142 kW (184-193 PS)	X5 3.0 d (E53) 330 d (E46) 330 xd (E39) 730 d (E38)	09/98-02/05										
					<b>02-35176-01</b> 11 12 2 248 985 	<b>08-37313-01</b> 11 11 2 248 975 	<b>04-10029-01</b>  	<b>61-35000-00</b> 11 12 2 248 982 84,5 Ø 1,45 mm MLS  1 <b>61-35000-10</b> 11 12 2 248 983 84,5 Ø 1,55 mm MLS  2 <b>61-35000-20</b> 11 12 2 248 984 84,5 Ø 1,65 mm MLS  3 	<b>14-32004-01</b> 11 12 9 067 790 	<b>71-37402-00</b> 11 12 7 796 378 	<b>12-35172-02</b> 11 34 9 071 732  <b>70-35172-00</b> 11 34 2 247 171  24x <b>71-33109-10</b>  6x 11 61 2 246 944 <b>71-77546-00</b>   6x 11 61 2 246 945 <b>71-33027-00</b>  3x 11 62 7 796 480 	<b>71-37313-00</b> 11 13 2 246 586 	<b>81-35723-00</b>   11 14 2 247 663 55x68 AB SL RD FPM  <b>81-20745-40</b>   11 14 2 245 364 90x110 A SL LD FPM 	
3,0	M57 D30 (306D2) N57 306 D2	150-160 kW (204-218 PS)	X3 3.0 d (E83) X5 3.0 d (E53) 330 Cd (E46) 330 d (E46) 330 xd (E46) 530 d (E60) 530 d (E61) 730 d (E65, E66, E67) 730 d (E65, E66)	06/02										
					<b>02-35176-02</b> 11 12 0 150 670 	<b>08-37313-02</b> 11 11 7 790 458 	<b>04-10029-01</b>  	<b>61-36620-00</b> 11 12 7 788 587 1,45 mm MLS  1 <b>61-36620-10</b> 11 12 7 788 588 1,55 mm MLS  2 <b>61-36620-20</b> 11 12 7 788 589 1,65 mm MLS  3 	<b>14-32004-01</b> 11 12 9 067 790 	<b>71-37402-00</b> 11 12 7 796 378 	<b>12-35172-02</b> 11 34 9 071 732  <b>70-35172-00</b> 11 34 2 247 171  24x <b>71-33109-10</b>  6x 11 61 2 246 944 <b>71-77546-00</b>   6x 11 61 2 246 945 <b>71-33027-00</b>  3x 11 62 7 796 480 	<b>71-37313-00</b> 11 13 2 246 586 	<b>81-37002-00</b>   11 11 8 604 931 55x68 AB RD PTFE  <b>81-90032-00</b>   11 14 7 787 262 	

BMW

Ltr.    1

3,0 M57 D30 (306D2) 155 kW (211 PS) 530 d (E60) 09/02-12/09

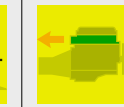
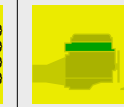

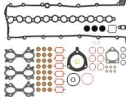

02-35176-02  
11 12 0 150 670





08-37313-02  
11 11 7 790 458



04-10029-01 



61-36620-00  
11 12 7 788 587  
1,45 mm  
MLS 

61-36620-10  
11 12 7 788 588  
1,55 mm  
MLS 

61-36620-20  
11 12 7 788 589  
1,65 mm  
MLS 

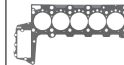

14-32004-01  
11 12 9 067 790

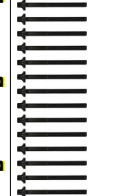

71-37402-00  
11 12 7 796 378

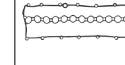

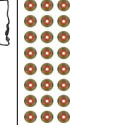

12-35172-02  
11 34 9 071 732





70-35172-00  
11 34 2 247 171



71-33109-10  6x  
11 61 2 246 944

71-77546-00   6x  
11 61 2 246 945

71-33027-00  3x  
11 62 7 796 480





71-37313-00  
11 13 2 246 586



81-37002-00   
11 11 8 604 931  
55x68  
AB RD PTFE



81-90032-00   
11 14 7 787 262



3,0 M57 D30 (306D3) 145-170 kW (197-231 PS) 325 d (E90)  
325 d (E91)  
325 d (E92)  
325 d (E93)  
330 d (E90)  
330 d (E92)  
330 d (E93)  
330 xd (E90)  
330 xd (E91)  
330 xd (E92) 12/04-12/13

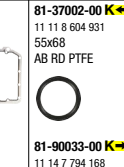
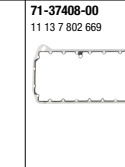
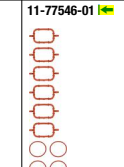
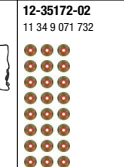
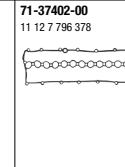
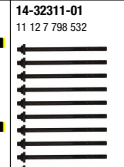
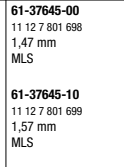

02-37402-02  
11 12 7 798 533



08-37408-01  
11 11 0 413 924



04-10275-01 



61-37645-00  
11 12 7 801 698  
1,47 mm  
MLS 

61-37645-10  
11 12 7 801 699  
1,57 mm  
MLS 

61-37645-20  
11 12 7 801 700  
1,67 mm  
MLS 

61-37645-30  
11 12 7 801 701  
1,77 mm  
MLS



14-32311-01  
11 12 7 798 532



71-37402-00  
11 12 7 796 378



12-35172-02  
11 34 9 071 732



70-35172-00  
11 34 2 247 171



71-33109-10  6x  
11 61 2 246 944

71-77546-01   6x  
11 61 2 246 945

71-33109-10  6x  
11 61 2 246 944

71-77546-00   6x  
11 61 2 246 945

71-37403-00  3x  
11 62 7 798 177



71-37408-00  
11 13 7 802 669



















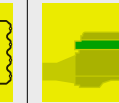
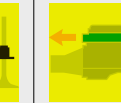
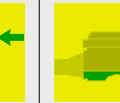

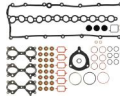

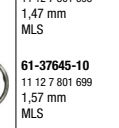
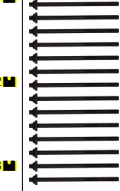
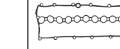
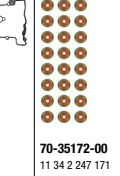
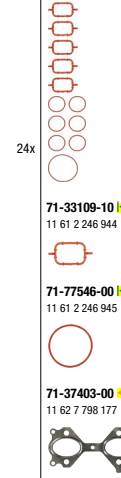

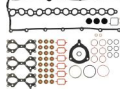

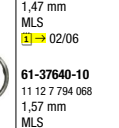

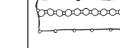
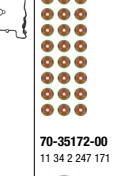













81-37002-00   
11 11 8 604 931  
55x68  
AB RD PTFE



81-90033-00   
11 14 7 794 168



BMW





















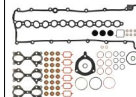



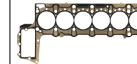

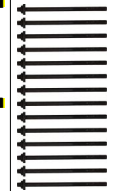
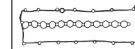
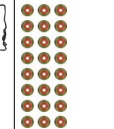
BMW														
3,0	M57 D30 (306D3)	145-173 kW (197-235 PS)	X5 3.0 d (E70) X6 3.0 d (E71) 525 d (E60) 525 d (E61) 525 d (E91) 525 xd (E60) 525 xd (E61) 530 d (E60) 530 d (E61) 530 xd (E60) 530 xd (E61)	02/05-05/10										
3,0	M57 D30 (306D3)	155 kW (211 PS)	X3 3.0 d (E83)	09/05-08/08										
					<p><b>02-37402-02</b> 11 12 7 798 533</p>	<p><b>08-37408-01</b> 11 11 0 413 924</p>	<p><b>04-10213-01</b> </p>	<p><b>61-37645-00</b> 11 12 7 801 698 1,47 mm MLS</p> <p><b>61-37645-10</b> 11 12 7 801 699 1,57 mm MLS</p> <p><b>61-37645-20</b> 11 12 7 801 700 1,67 mm MLS</p> <p><b>61-37645-30</b> 11 12 7 801 701 1,77 mm MLS</p>	<p><b>14-32311-01</b> 11 12 7 798 532</p>	<p><b>71-37402-00</b> 11 12 7 796 378</p>	<p><b>12-35172-02</b> 11 34 9 071 732</p> <p><b>70-35172-00</b> 11 34 2 247 171</p>	<p><b>11-77546-01</b> </p> <p><b>71-33109-10</b> </p> <p><b>71-77546-00</b>  </p> <p><b>71-37403-00</b> </p>	<p><b>71-37408-00</b> 11 13 7 802 669</p>	<p><b>81-37002-00</b> </p> <p>11 11 8 604 931 55x68 AB RD PTFE</p> <p><b>81-90033-00</b> </p> <p>11 14 7 794 168</p>
					<p><b>02-37402-02</b> 11 12 7 798 533</p>	<p><b>08-37408-01</b> 11 11 0 413 924</p>	<p><b>04-10213-01</b> </p>	<p><b>61-37640-00</b> 11 12 7 794 067 1,47 mm MLS </p> <p><b>61-37640-10</b> 11 12 7 794 068 1,57 mm MLS </p> <p><b>61-37640-20</b> 11 12 7 794 069 1,67 mm MLS </p> <p><b>61-37640-30</b> 11 12 7 794 057 1,77 mm MLS </p>	<p><b>14-32311-01</b> 11 12 7 798 532</p>	<p><b>71-37402-00</b> 11 12 7 796 378</p>	<p><b>12-35172-02</b> 11 34 9 071 732</p> <p><b>70-35172-00</b> 11 34 2 247 171</p>	<p><b>11-77546-01</b> </p> <p><b>71-33109-10</b> </p> <p><b>71-77546-00</b>  </p> <p><b>71-37403-00</b> </p>	<p><b>71-37408-00</b> 11 13 7 802 669</p>	<p><b>81-37002-00</b> </p> <p>11 11 8 604 931 55x68 AB RD PTFE</p> <p><b>81-90033-00</b> </p> <p>11 14 7 794 168</p>

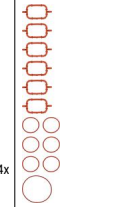
BMW



Ltr.	Motor	Power	Model	Year	Image 1	Image 2	Image 3	Image 4	Image 5	Image 6	Image 7	Image 8	Image 9	Image 10	Image 11					
3,0	M57 D30 (306D3)	155-160 kW (211-218 PS)	X3 3.0 d (E83) X3 3.0 d (E83) 325 d (E92) 325 d (E93) 330 d (E90) 530 d (E60) 530 d (E61) 730 d (E65, E66)	09/02-12/11																
					<b>02-37402-02</b> 11 12 7 798 533	<b>08-37408-01</b> 11 11 0 413 924			<b>61-37645-00</b> 11 12 7 801 698 1,47 mm MLS  <b>61-37645-10</b> 11 12 7 801 699 1,57 mm MLS  <b>61-37645-20</b> 11 12 7 801 700 1,67 mm MLS  <b>61-37645-30</b> 11 12 7 801 701 1,77 mm MLS	<b>14-32311-01</b> 11 12 7 798 532	<b>71-37402-00</b> 11 12 7 796 378	<b>12-35172-02</b> 11 34 9 071 732	<b>11-77546-01</b>	<b>71-37408-00</b> 11 13 7 802 669	<b>81-37002-00</b> 11 11 8 604 931 55x68 AB RD PTFE  <b>81-90033-00</b> 11 14 7 794 168					
												<b>70-35172-00</b> 11 34 2 247 171	24x	<b>71-33109-10</b> 11 61 2 246 944	6x	<b>71-77546-00</b> 11 61 2 246 945	6x	<b>71-37403-00</b> 11 62 7 798 177	3x	
3,0	M57 D30 (306D3)	155-173 kW (211-235 PS)	X5 3.0 d (E70)	12/06-09/08					<b>61-37645-00</b> 11 12 7 801 698 1,47 mm MLS  <b>61-37645-10</b> 11 12 7 801 699 1,57 mm MLS  <b>61-37645-20</b> 11 12 7 801 700 1,67 mm MLS  <b>61-37645-30</b> 11 12 7 801 701 1,77 mm MLS	<b>14-32311-01</b> 11 12 7 798 532	<b>71-37402-00</b> 11 12 7 796 378	<b>12-35172-02</b> 11 34 9 071 732	<b>11-77546-01</b>	<b>71-37408-00</b> 11 13 7 802 669	<b>81-37002-00</b> 11 11 8 604 931 55x68 AB RD PTFE  <b>81-90033-00</b> 11 14 7 794 168					
					<b>02-37402-02</b> 11 12 7 798 533	<b>08-37408-01</b> 11 11 0 413 924	<b>04-10256-01</b>													
												<b>70-35172-00</b> 11 34 2 247 171	24x	<b>71-33109-10</b> 11 61 2 246 944	6x	<b>71-77546-00</b> 11 61 2 246 945	6x	<b>71-37403-00</b> 11 62 7 798 177	3x	

BMW

Ltr.  3,0 M57 D30 (306D3) 170 kW (231 PS) 730 Ld (E65,E66)  07/05-08/08

										
	<p><b>02-37402-02</b> 11 12 7 798 533</p> 	<p><b>08-37406-02</b> 11 11 7 798 531 1,47 mm MLS [1] ⇒ 02/06</p>  <p><b>08-37408-01</b> 11 11 0 413 924</p> 	<p><b>04-10213-01</b> [1]</p> 	<p><b>61-37640-00</b> 11 12 7 794 067 1,47 mm MLS [1] ⇒ 02/06</p> <p><b>61-37640-10</b> 11 12 7 794 068 1,57 mm MLS [1] ⇒ 02/06</p> <p><b>61-37640-20</b> 11 12 7 794 069 1,67 mm MLS [1] ⇒ 02/06</p> <p><b>61-37640-30</b> 11 12 7 794 857 1,77 mm MLS [1] ⇒ 02/06</p>  <p><b>61-37645-20</b> 11 12 7 801 700 1,67 mm MLS [1] 03/06 →</p> <p><b>61-37645-00</b> 11 12 7 801 698 1,47 mm MLS</p> <p><b>61-37645-10</b> 11 12 7 801 699 1,57 mm MLS</p> <p><b>61-37645-30</b> 11 12 7 801 701 1,77 mm MLS</p> 	<p><b>14-32311-01</b> 11 12 7 798 532</p> 	<p><b>71-37402-00</b> 11 12 7 796 378</p> 	<p><b>12-35172-02</b> 11 34 9 071 732</p>  <p><b>70-35172-00</b> 11 34 2 247 171</p> 	<p><b>11-77546-01</b> [1] [2]</p>  <p><b>11-33109-10</b> [1] [2]</p>  <p><b>11-77546-00</b> [1] [2] [3]</p>  <p><b>71-37403-00</b> [1]</p> 	<p><b>71-37406-00</b> 11 13 7 798 122 [1] ⇒ 02/06</p>  <p><b>71-37408-00</b> 11 13 7 802 669</p> 	<p><b>81-35723-00</b> [1] [2]</p>  <p><b>81-37002-00</b> [1] [2]</p>  <p><b>81-90033-00</b> [1] [2]</p> 

BMW

Ltr.   

3,0 M57 D30 (306D4) 198 kW (269 PS) 335 d (E90) 09/08-12/11

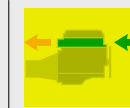
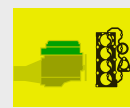

3,0 M57 D30 (306D4) 198 kW (269 PS) 335 d (E90) 09/08-12/11

**02-37402-01**  
11 12 0 393 750

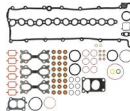

**08-37313-03**  
11 11 0 395 221



**61-36620-00**  
11 12 7 788 587  
1,45 mm  
MLS

**1**

**61-36620-10**  
11 12 7 788 588  
1,55 mm  
MLS

**2**

**61-36620-20**  
11 12 7 788 589  
1,65 mm  
MLS

**3**



**14-32004-01**  
11 12 9 067 790

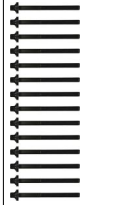

**71-37402-00**  
11 12 7 796 378

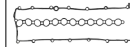

**12-35172-02**  
11 34 9 071 732

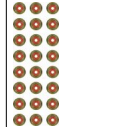

**70-35172-00**  
11 34 2 247 171



**11-77546-01**

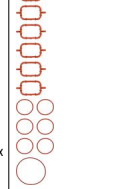

**6x**

**11-77546-00**

**6x**

**11-77546-01**

**3x**

**11-77546-00**

**3x**

**11-77546-01**

**3x**

**71-37313-00**  
11 13 2 246 586



**81-37002-00**

11 11 8 604 931

55x68

AB RD PTFE

**81-90032-00**

11 14 7 787 262



3,0 M57 D30 (306D4) 200 kW (272 PS) 535 d (E60) 09/04-12/10  
535 d (E61)

**02-37402-01**  
11 12 0 393 750

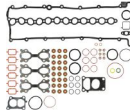

**08-37313-03**  
11 11 0 395 221



**61-36620-00**  
11 12 7 788 587  
1,45 mm  
MLS

**1**

**61-36620-10**  
11 12 7 788 588  
1,55 mm  
MLS

**2**

**61-36620-20**  
11 12 7 788 589  
1,65 mm  
MLS

**3**



**14-32004-01**  
11 12 9 067 790

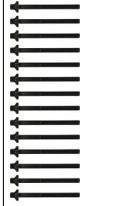

**71-37402-00**  
11 12 7 796 378

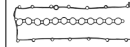

**12-35172-02**  
11 34 9 071 732

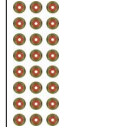

**70-35172-00**  
11 34 2 247 171



**11-77546-01**

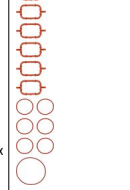

**6x**

**11-77546-00**

**6x**

**11-77546-01**

**3x**

**11-77546-00**

**3x**

**71-37313-00**  
11 13 2 246 586



**81-37002-00**

11 11 8 604 931

55x68





















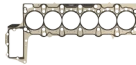

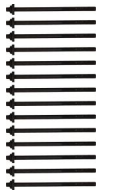

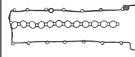

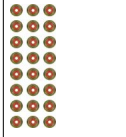

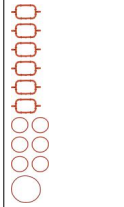











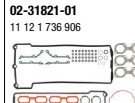
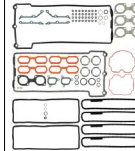

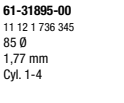
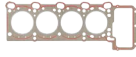
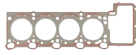
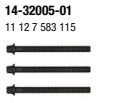

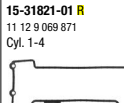

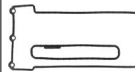

















AB RD PTFE

**81-90032-00**

11 14 7 787 262

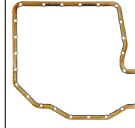

BMW

<p>Ltr. </p> <p>3,0 M57 D30 (306D5) 210 kW (286 PS)</p> <p>  03/06-07/13</p> <p>X3 3.0 sd (E83) X3 3.5 d (E83) X5 3.0 sd (E70) X5 3.5 d (E70) X6 3.5 d (E71) 335 d (E90) 335 d (E91) 335 d (E92) 535 d (E60) 535 d (E61) 635 d (E63) 635 d (E64)</p>		 <p><b>02-37402-03</b> 11 12 0 421 276</p> 	 <p><b>08-37408-01</b> 11 11 0 413 924</p> 		 <p><b>61-37645-00</b> 11 12 7 801 698 1,47 mm MLS</p> <p><b>61-37645-10</b> 11 12 7 801 699 1,57 mm MLS</p> <p><b>61-37645-20</b> 11 12 7 801 700 1,67 mm MLS</p> <p><b>61-37645-30</b> 11 12 7 801 701 1,77 mm MLS</p> 	 <p><b>14-32311-01</b> 11 12 7 798 532</p> 	 <p><b>71-37402-00</b> 11 12 7 796 378</p> 	 <p><b>12-35172-02</b> 11 34 9 071 732</p> 	 <p><b>11-77546-01</b> </p>  <p><b>71-33109-10</b>  6x 11 61 2 246 944</p> <p><b>71-77546-00</b>   6x 11 61 2 246 945</p> <p><b>71-39388-00</b>  3x 11 62 7 799 728</p> 	 <p><b>71-37408-00</b> 11 13 7 802 669</p> 	 <p><b>81-37002-00</b>  11 11 8 604 931 55x68 AB RD PTFE</p> <p><b>81-90033-00</b>  11 14 7 794 168</p> 
<p>3,0 M60 B30 155-160 kW (211-218 PS)</p>		 <p><b>02-31821-01</b> 11 12 1 736 906</p> 	 <p><b>08-31828-01</b> 11 11 9 070 240</p> 		 <p><b>61-31895-00</b> 11 12 1 736 345 85 Ø 1,77 mm Cyl. 1-4</p> <p><b>61-31895-10</b> 11 12 1 736 350 85 Ø 2,07 mm Cyl. 1-4</p>  <p><b>61-31900-00</b> 11 12 1 736 346 85 Ø 1,77 mm Cyl. 5-8</p> <p><b>61-31900-10</b> 11 12 1 736 349 85 Ø 2,07 mm Cyl. 5-8</p> 	 <p><b>14-32005-01</b> 2x 11 12 7 583 115</p> 	 <p><b>15-31821-01</b>  R 11 12 9 069 871 Cyl. 1-4</p>  <p><b>15-31822-01</b>  L 11 12 9 069 872 Cyl. 5-8</p> 	 <p><b>12-31306-12</b> 2x 11 34 9 063 193</p>  <p><b>70-31306-00</b> 32x 11 34 2 245 151</p> 	 <p><b>71-31853-00</b>  4x 11 61 1 433 328</p>  <p><b>71-31826-00</b>   2x 11 61 1 729 727</p>  <p><b>71-31827-00</b>   2x 11 61 1 729 728</p>  <p><b>71-31834-10</b>  3x 11 62 7 505 789</p>  <p><b>71-31836-10</b>  2x 11 62 7 509 677</p>  <p><b>71-31833-00</b>   4x 18 30 1 728 734</p> 	 <p><b>71-31828-00</b> 11 13 1 725 222</p>  <p><b>71-31837-00</b>  11 13 1 436 324</p> 	 <p><b>81-17404-50</b>  11 14 1 265 431 48x65 AB SL RD FPM</p> <p><b>81-27373-00</b>  11 14 1 713 730 100x125 A SL LD FPM</p> 

BMW														
Ltr.														
3,0	M60 B30 (30BS1)	155-160 kW (211-218 PS)	530 i V8 (E34) 730 i, iL (E32) 730 i, iL (E38)	04/92-11/01										
					<p><b>02-31821-01</b> 11 12 1 736 906</p>	<p><b>08-31828-01</b> 11 11 9 070 240</p>		<p><b>61-31895-00</b> 11 12 1 736 345 85 Ø 1,77 mm Cyl. 1-4</p> <p><b>61-31895-10</b> 11 12 1 736 350 85 Ø 2,07 mm Cyl. 1-4</p> <p><b>61-31900-00</b> 11 12 1 736 346 85 Ø 1,77 mm Cyl. 5-8</p> <p><b>61-31900-10</b> 11 12 1 736 349 85 Ø 2,07 mm Cyl. 5-8</p>	<p><b>14-32005-01</b> 11 12 7 583 115</p>	<p><b>15-31821-01 R</b> 11 12 9 069 871</p> <p><b>15-31822-01 L</b> 11 12 9 069 872</p>	<p><b>12-31306-12</b> 11 34 9 063 193</p> <p><b>70-31306-00</b> 11 34 2 245 151</p>	<p><b>71-31853-00</b>  4x 11 61 1 433 328</p> <p><b>71-31826-00</b>  11 61 1 729 727</p> <p><b>71-31827-00</b>  11 61 1 729 728</p> <p><b>71-31834-10</b>  11 62 7 505 789</p> <p><b>71-31836-10</b>  11 62 7 509 677</p> <p><b>71-31833-00</b>    4x 18 30 1 728 734</p>	<p><b>71-31828-00</b> 11 13 1 725 222</p> <p><b>71-31837-00</b>  11 13 1 436 324</p>	<p><b>81-17404-50 K</b>  11 14 1 265 431 48x65 AB SL RD FPM</p> <p><b>81-27373-00 K</b>  11 14 1 713 730 100x125 A SL LD FPM</p>
3,0	N51 B30 A	171-172 kW (234 PS)	128 i (E88) 328 i (E92) 328 i xDrive (E90) 328 xi (E91)	06/06-10/13	<p><b>02-37159-01</b> 11 12 7 571 963 +11 34 0 035 853</p>	<p><b>08-38669-01</b> 11 11 7 548 101</p>		<p><b>61-36120-00</b> 11 12 7 548 797 85,5 Ø 1,2 mm MLS</p> <p><b>61-36120-10</b> 11 12 7 553 210 85,5 Ø 1,5 mm MLS</p>	<p><b>14-32315-01</b> 11 12 7 548 799</p>	<p><b>15-37159-01</b> 11 12 7 582 245</p>	<p><b>12-36866-01</b> 11 34 0 034 068</p> <p><b>12-37256-01</b> 11 34 0 035 853</p>	<p><b>11-37133-01</b>  11 61 7 547 242</p> <p><b>71-37134-00</b>   6x 18 40 7 530 606</p> <p><b>71-37136-00</b>    2x 18 10 7 549 447</p>	<p><b>71-38669-00</b> 11 13 7 548 031</p>	<p><b>81-34057-00 K</b>  11 11 7 547 842 65x79 A SL RD PTFE ACM</p> <p><b>81-37122-00 K</b>  11 11 7 584 398 90x110 A SL LD PTFE (Polytetrafluorethylen)/ACM (Polyacryl-Kautschuk)   01/09</p> <p><b>81-40292-00 K</b>  11 11 7 587 168 90x110 A LD FPM  02/09 →</p>























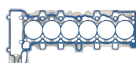



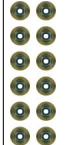

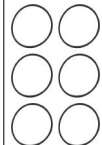









BMW





Ltr.														
3,0	N51 B30 A	171-172 kW (234 PS)	328 xi (E90) 328 xi (E91)	09/06-12/08										
					<b>02-37159-01</b> 11 12 7 571 963 +11 34 0 035 853 	<b>08-38669-01</b> 11 11 7 548 101 	<b>61-36120-00</b> 11 12 7 548 797 85,5 Ø 1,2 mm MLS  <b>61-36120-10</b> 11 12 7 553 210 85,5 Ø 1,5 mm MLS 	<b>14-32315-01</b> 11 12 7 548 799 	<b>15-37159-01</b> 11 12 7 582 245 	<b>12-36866-01</b> 11 34 0 034 068  <b>12-37256-01</b> 11 34 0 035 853 	<b>11-37133-01</b> 11 61 7 547 242  <b>71-37134-00</b> 6x 18 40 7 530 606  <b>71-37136-00</b> 2x 18 10 7 549 447 	<b>71-38669-00</b> 11 13 7 548 031 	<b>81-34057-00</b> 11 11 7 547 842 65x79 A SL RD PTFE ACM  <b>81-37122-00</b> 11 11 7 584 398 90x110 A SL LD PTFE (Polytetrafluorethylen)/ACM (Polyacryl-Kautschuk) 	
3,0	N51 B30 A	172 kW (234 PS)	325 xi (E92)	09/06-08/08										
					<b>02-37159-01</b> 11 12 7 571 963 +11 34 0 035 853 	<b>08-38669-01</b> 11 11 7 548 101 	<b>61-36120-00</b> 11 12 7 548 797 85,5 Ø 1,2 mm MLS  <b>61-36120-10</b> 11 12 7 553 210 85,5 Ø 1,5 mm MLS 	<b>14-32315-01</b> 11 12 7 548 799 	<b>15-37159-01</b> 11 12 7 582 245 	<b>12-36866-01</b> 11 34 0 034 068  <b>12-37256-01</b> 11 34 0 035 853 	<b>11-37133-01</b> 11 61 7 547 242  <b>71-37134-00</b> 6x 18 40 7 530 606  <b>71-37136-00</b> 2x 18 10 7 549 447 	<b>71-38669-00</b> 11 13 7 548 031 	<b>81-10378-00</b> 11 11 8 618 864 65x79 RD FPM  <b>81-34057-00</b> 11 11 7 547 842 65x79 A SL RD PTFE ACM  <b>81-40292-00</b> 11 11 7 587 168 90x110 A LD FPM 	
3,0	N51 B30 A	172 kW (234 PS)	328 i (E90)	09/06-12/11										
					<b>02-37159-01</b> 11 12 7 571 963 +11 34 0 035 853 	<b>08-38669-01</b> 11 11 7 548 101 	<b>61-36120-00</b> 11 12 7 548 797 85,5 Ø 1,2 mm MLS  <b>61-36120-10</b> 11 12 7 553 210 85,5 Ø 1,5 mm MLS 	<b>14-32315-01</b> 11 12 7 548 799 	<b>15-37159-01</b> 11 12 7 582 245 	<b>12-36866-01</b> 11 34 0 034 068  <b>12-37256-01</b> 11 34 0 035 853 	<b>11-37133-01</b> 11 61 7 547 242  <b>71-37134-00</b> 6x 18 40 7 530 606  <b>71-37136-00</b> 2x 18 10 7 549 447 	<b>71-38669-00</b> 11 13 7 548 031 	<b>81-34057-00</b> 11 11 7 547 842 65x79 A SL RD PTFE ACM  <b>81-40292-00</b> 11 11 7 587 168 90x110 A LD FPM 	

BMW

Ltr.  3,0 N51 B30 A 172 kW (234 PS) 328i (E93)  03/07-10/13  1

										
	<p><b>02-37159-01</b> 11 12 7 571 963 +11 34 0 035 853</p> 	<p><b>08-38669-01</b> 11 11 7 548 101</p> 		<p><b>61-36120-00</b> 11 12 7 548 797 85,5 Ø 1,2 mm MLS</p> <p><b>61-36120-10</b> 11 12 7 553 210 85,5 Ø 1,5 mm MLS</p> 	<p><b>14-32315-01</b> 11 12 7 548 799</p> 	<p><b>15-37159-01</b> 11 12 7 582 245</p> 	<p><b>12-36866-01</b> 11 34 0 034 068</p>  <p><b>12-37256-01</b> 11 34 0 035 853</p> 	<p><b>11-37133-01</b> </p> <p>11 61 7 547 242</p>  <p><b>71-37134-00</b>  6x 18 40 7 530 606</p>  <p><b>71-37136-00</b>  2x 18 10 7 549 447</p> 	<p><b>71-38669-00</b> 11 13 7 548 031</p> 	<p><b>81-34057-00</b> </p> <p>11 11 7 547 842 65x79 A SL RD PTFE/ACM  02/11</p>  <p><b>81-10378-00</b> </p> <p>11 11 8 618 864 65x79 RD FPM  03/11 →</p>  <p><b>81-37122-00</b> </p> <p>11 11 7 584 398 90x110 A SL LD PTFE (Polytetrafluorethylen)/ACM (Polyacryl-Kautschuk)  01/09</p>  <p><b>81-40292-00</b> </p> <p>11 11 7 587 168 90x110 A LD FPM  02/09 →</p> 

BMW

Ltr.     1

3,0 N52 B30  
N52 B30 A

190-200 kW (258-272 PS)

Z4 3.0 si (E85)  
130i (E87)  
330i (E90)  
330xi (E91)  
530i (E60)  
530i (E61)  
530xi (E60)  
530xi (E61)  
630i (E63)  
630i (E64)

09/04

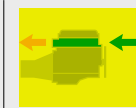

**02-37289-01**  
11 12 7 548 921  
+11 34 0 035 853  
+11 34 0 032 582

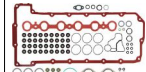

**02-37289-02**  
11 12 7 548 921

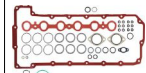

**08-38669-01**  
11 11 7 548 101



**61-36120-00**  
11 12 7 548 797  
85,5 Ø  
1,2 mm  
MLS

**61-36120-10**  
11 12 7 553 210  
85,5 Ø  
1,5 mm  
MLS

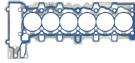

**14-32315-01**  
11 12 7 548 799



**15-37289-01**  
11 12 7 581 215

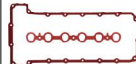

**12-36866-02**  
11 34 0 032 582  
1 → 03/06

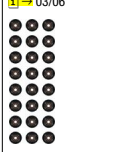



**12-36866-01**  
11 34 0 034 068  
1 → 04/06 →



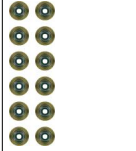

**12-37256-01**  
11 34 0 035 853  
1 → 04/06 →



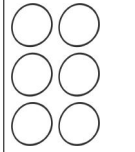

**11-37133-01**    
11 61 7 547 242



**71-37134-00**   6x  
18 40 7 530 606





**71-37136-00**   2x  
18 10 7 549 447





**71-38669-00**  
11 13 7 548 031





**81-34057-00**    
11 11 7 547 842  
65x79  
A SL RD PTFE ACM























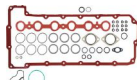

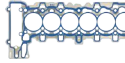





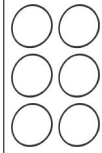







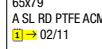





**81-37122-00**    
11 11 7 584 398  
90x110  
A SL LD PTFE  
(Polytetrafluorethylen)/ACM  
(Polyacryl-Kautschuk)













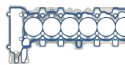

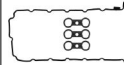



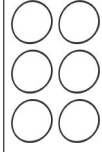







BMW

Ltr.  3,0 N52 B30 A 160 kW (218 PS) 125 i (E82)  03/08-10/13

										
	<p><b>02-37289-01</b> 11 12 7 548 921 +11 34 0 035 853 +11 34 0 032 582</p>  <p><b>02-37289-02</b> 11 12 7 548 921</p> 	<p><b>08-38669-01</b> 11 11 7 548 101</p> 		<p><b>61-36120-00</b> 11 12 7 548 797 85,5 Ø 1,2 mm MLS</p> <p><b>61-36120-10</b> 11 12 7 553 210 85,5 Ø 1,5 mm MLS</p> 	<p><b>14-32315-01</b> 11 12 7 548 799</p> 	<p><b>15-37289-01</b> 11 12 7 581 215</p> 	<p><b>12-36866-01</b> 11 34 0 034 068</p>  <p><b>12-37256-01</b> 11 34 0 035 853</p> 	<p><b>11-37133-01</b> </p>  <p><b>11-37134-00</b>  6x</p>  <p><b>11-37136-00</b>   2x</p> 	<p><b>71-38669-00</b> 11 13 7 548 031</p> 	<p><b>81-34057-00</b> </p>  <p>11 11 7 547 842 65x79 A SL RD PTFE ACM  02/11</p>  <p><b>81-10378-00</b> </p>  <p>11 11 8 618 864 65x79 RD FPM  03/11 →</p>  <p><b>81-37122-00</b> </p>  <p>11 11 7 584 398 90x110 A SL LD PTFE (Polytetrafluorethylen)/ACM (Polyacryl-Kautschuk)  01/09</p>  <p><b>81-40292-00</b> </p>  <p>11 11 7 587 168 90x110 A LD FPM  02/09 →</p> 

3,0 N52 B30 A 160 kW (218 PS) 125 i (E88) 12/07-10/13

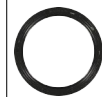
	<p><b>02-37159-01</b> 11 12 7 571 963 +11 34 0 035 853</p> 	<p><b>08-38669-01</b> 11 11 7 548 101</p> 		<p><b>61-36120-00</b> 11 12 7 548 797 85,5 Ø 1,2 mm MLS</p> <p><b>61-36120-10</b> 11 12 7 553 210 85,5 Ø 1,5 mm MLS</p> 	<p><b>14-32315-01</b> 11 12 7 548 799</p> 	<p><b>15-37159-01</b> 11 12 7 582 245</p> 	<p><b>12-36866-01</b> 11 34 0 034 068</p>  <p><b>12-37256-01</b> 11 34 0 035 853</p> 	<p><b>11-37133-01</b> </p>  <p><b>11-37134-00</b>  6x</p>  <p><b>11-37136-00</b>   2x</p> 	<p><b>71-38669-00</b> 11 13 7 548 031</p> 	<p><b>81-34057-00</b> </p>  <p>11 11 7 547 842 65x79 A SL RD PTFE ACM</p>  <p><b>81-37122-00</b> </p>  <p>11 11 7 584 398 90x110 A SL LD PTFE (Polytetrafluorethylen)/ACM (Polyacryl-Kautschuk)  01/09</p>  <p><b>81-40292-00</b> </p>  <p>11 11 7 587 168 90x110 A LD FPM  02/09 →</p> 
--	---	---	--	---	--	--	--	--	--	--

BMW

Ltr.	Motor	Power	Model	Year	Image 1	Image 2	Image 3	Image 4	Image 5	Image 6	Image 7	Image 8	Image 9	Image 10	Image 11	Image 12
3,0	N52 B30 A	160 kW (218 PS)	325 xi (E90) 525i (E60)	03/05-03/07												
						<p><b>02-37289-01</b> 11 12 7 548 921 +11 34 0 035 853 +11 34 0 032 582</p> <p><b>02-37289-02</b> 11 12 7 548 921</p>	<p><b>08-38669-01</b> 11 11 7 548 101</p>		<p><b>61-36120-00</b> 11 12 7 548 797 85,5 Ø 1,2 mm MLS</p> <p><b>61-36120-10</b> 11 12 7 553 210 85,5 Ø 1,5 mm MLS</p>	<p><b>14-32315-01</b> 11 12 7 548 799</p>	<p><b>15-37289-01</b> 11 12 7 581 215</p>	<p><b>12-36866-02</b> 11 34 0 032 582 1 → 03/06</p> <p><b>12-36866-01</b> 11 34 0 034 068 1 → 04/06 →</p> <p><b>12-37256-01</b> 11 34 0 035 853 1 → 04/06 →</p>	<p><b>11-37133-01</b> </p> <p><b>71-37134-00</b>  6x</p> <p><b>71-37136-00</b>   2x</p>	<p><b>71-38669-00</b> 11 13 7 548 031</p> <p><b>71-41291-00</b> 11 13 7 600 482</p>	<p><b>81-34057-00</b> </p> <p>11 11 7 547 842 65x79 A SL RD PTFE ACM</p> <p><b>81-37122-00</b> </p> <p>11 11 7 584 398 90x110 A SL LD PTFE (Polytetrafluorethylen)/ACM (Polyacryl-Kautschuk)</p>	
3,0	N52 B30 A	160-190 kW (218-258 PS)	X1 xDrive 25 i (E84) X1 xDrive 28 i (E84) Z4 3.0 i (E89)	02/09-08/11												
						<p><b>02-37159-01</b> 11 12 7 571 963 +11 34 0 035 853</p>	<p><b>08-38669-01</b> 11 11 7 548 101</p>		<p><b>61-36120-00</b> 11 12 7 548 797 85,5 Ø 1,2 mm MLS</p> <p><b>61-36120-10</b> 11 12 7 553 210 85,5 Ø 1,5 mm MLS</p>	<p><b>14-32315-01</b> 11 12 7 548 799</p>	<p><b>15-37159-01</b> 11 12 7 582 245</p>	<p><b>12-36866-01</b> 11 34 0 034 068</p> <p><b>12-37256-01</b> 11 34 0 035 853</p>	<p><b>11-37133-01</b> </p> <p><b>71-37134-00</b>  6x</p> <p><b>71-37136-00</b>   2x</p>	<p><b>71-38669-00</b> 11 13 7 548 031</p>	<p><b>81-34057-00</b> </p> <p>11 11 7 547 842 65x79 A SL RD PTFE ACM</p> <p><b>81-40292-00</b> </p> <p>11 11 7 587 168 90x110 A LD FPM</p>	

**BMW**



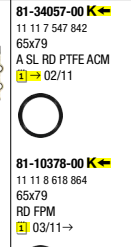
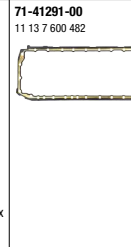
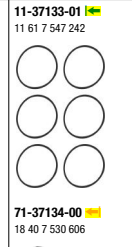
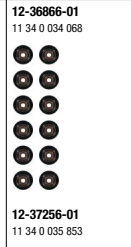
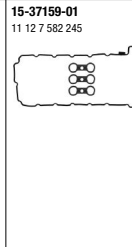
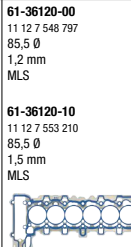
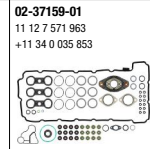
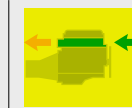
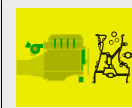



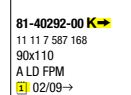
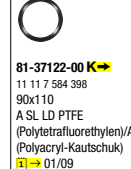
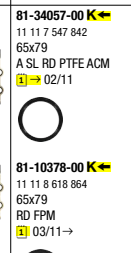
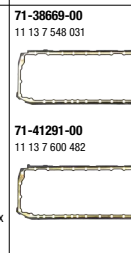
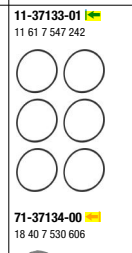
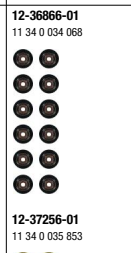
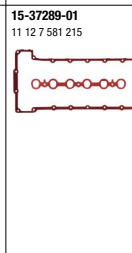
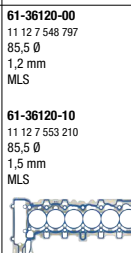
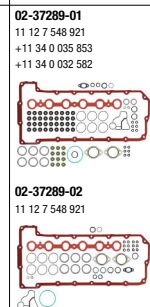











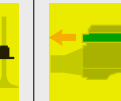







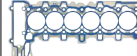



















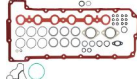

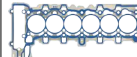











Ltr.   
 3,0 N52 B30 A 160-200 kW (218-272 PS) Z4 3.0 i (E89) 09/06-06/15  
 N52 B30 BF 125 i (E82) 125 i (E88) 130 i (E81, E87) 330 i (E90) 530 i (F10) 730 i (F01, F02)

















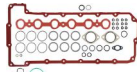



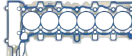







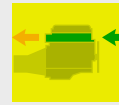

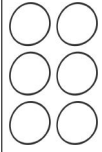

















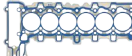





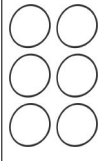















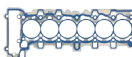

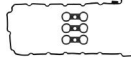

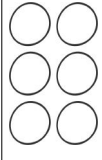

3,0 N52 B30 A 172 kW (234 PS) 328 i (E92) 06/06-06/13



BMW

BMW															
Ltr.															
3,0	N52 B30 A	172 kW (234 PS)	528 i (E60)	03/07-12/09	<p><b>02-37159-01</b> 11 12 7 571 963 +11 34 0 035 853</p> 	<p><b>08-38669-01</b> 11 11 7 548 101</p> 		<p><b>61-36120-00</b> 11 12 7 548 797 85,5 Ø 1,2 mm MLS</p> <p><b>61-36120-10</b> 11 12 7 553 210 85,5 Ø 1,5 mm MLS</p> 	<p><b>14-32315-01</b> 11 12 7 548 799</p> 		<p><b>12-36866-01</b> 11 34 0 034 068</p>  <p><b>12-37256-01</b> 11 34 0 035 853</p> 	<p><b>11-37133-01</b> </p> <p>11 61 7 547 242</p>  <p><b>71-37134-00</b>  6x</p> <p>18 40 7 530 606</p> <p><b>71-37136-00</b>   2x</p> <p>18 10 7 549 447</p>  	<p><b>71-38669-00</b> 11 13 7 548 031</p> 	<p><b>81-34057-00</b> </p> <p>11 11 7 547 842 65x79 A SL RD PTFE ACM</p>  <p><b>81-37122-00</b> </p> <p>11 11 7 584 398 90x110 A SL LD PTFE (Polytetrafluorethylen)/ACM (Polyacryl-Kautschuk)  01/09</p>  <p><b>81-40292-00</b> </p> <p>11 11 7 587 168 90x110 A LD FPM  02/09→</p> 	
3,0	N52 B30 A	172-200 kW (234-272 PS)	328 i xDrive (E90) 330 i (E92)	09/06-12/10	<p><b>02-37289-01</b> 11 12 7 548 921 +11 34 0 035 853 +11 34 0 032 582</p>  <p><b>02-37289-02</b> 11 12 7 548 921</p> 	<p><b>08-38669-01</b> 11 11 7 548 101</p> 		<p><b>61-36120-00</b> 11 12 7 548 797 85,5 Ø 1,2 mm MLS</p> <p><b>61-36120-10</b> 11 12 7 553 210 85,5 Ø 1,5 mm MLS</p> 	<p><b>14-32315-01</b> 11 12 7 548 799</p> 	<p><b>15-37289-01</b> 11 12 7 581 215</p> 	<p><b>12-36866-01</b> 11 34 0 034 068</p>  <p><b>12-37256-01</b> 11 34 0 035 853</p> 	<p><b>11-37133-01</b> </p> <p>11 61 7 547 242</p>  <p><b>71-37134-00</b>  6x</p> <p>18 40 7 530 606</p> <p><b>71-37136-00</b>   2x</p> <p>18 10 7 549 447</p>  	<p><b>71-38669-00</b> 11 13 7 548 031</p>  <p><b>71-41291-00</b> 11 13 7 600 482</p> 	<p><b>81-34057-00</b> </p> <p>11 11 7 547 842 65x79 A SL RD PTFE ACM</p>  <p><b>81-37122-00</b> </p> <p>11 11 7 584 398 90x110 A SL LD PTFE (Polytetrafluorethylen)/ACM (Polyacryl-Kautschuk)  01/09</p>  <p><b>81-40292-00</b> </p> <p>11 11 7 587 168 90x110 A LD FPM  02/09→</p> 	

















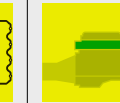
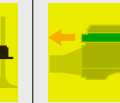
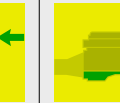
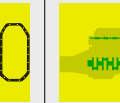

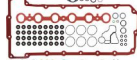

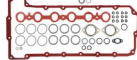



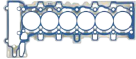

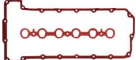







BMW

<p>Ltr.  N52 B30 A</p> <p>172-200 kW (234-272 PS)</p> <p>328 xi (E90) 530 xi (E61)</p> <p>09/06-05/10 </p>		 <p><b>02-37289-01</b> 11 12 7 548 921 +11 34 0 035 853 +11 34 0 032 582</p>  <p><b>02-37289-02</b> 11 12 7 548 921</p> 	 <p><b>08-38669-01</b> 11 11 7 548 101</p> 		 <p><b>61-36120-00</b> 11 12 7 548 797 85,5 Ø 1,2 mm MLS</p> <p><b>61-36120-10</b> 11 12 7 553 210 85,5 Ø 1,5 mm MLS</p> 	 <p><b>14-32315-01</b> 11 12 7 548 799</p> 	 <p><b>15-37289-01</b> 11 12 7 581 215</p> 	 <p><b>12-36866-01</b> 11 34 0 034 068</p>  <p><b>12-37256-01</b> 11 34 0 035 853</p> 	 <p><b>11-37133-01</b> </p> <p>11 61 7 547 242</p>  <p><b>71-37134-00</b>  6x</p> <p>18 40 7 530 606</p> <p><b>71-37136-00</b>   2x</p> <p>18 10 7 549 447</p>  	 <p><b>71-38669-00</b> 11 13 7 548 031</p>  <p><b>71-41291-00</b> 11 13 7 600 482</p> 	 <p><b>81-34057-00</b> </p> <p>11 11 7 547 842 65x79 A SL RD PTFE ACM</p>  <p><b>81-37122-00</b> </p> <p>11 11 7 584 398 90x110 A SL LD PTFE (Polytetrafluorethylen)/ACM (Polyacryl-Kautschuk)</p> 
<p>3,0 N52 B30 A</p> <p>179 kW (243 PS)</p> <p>528 i (F10)</p> <p>10/09-08/11</p>		<p><b>02-37159-01</b> 11 12 7 571 963 +11 34 0 035 853</p> 			<p><b>61-36120-00</b> 11 12 7 548 797 85,5 Ø 1,2 mm MLS</p> <p><b>61-36120-10</b> 11 12 7 553 210 85,5 Ø 1,5 mm MLS</p> 	<p><b>14-32315-01</b> 11 12 7 548 799</p> 	<p><b>15-37159-01</b> 11 12 7 582 245</p> 	<p><b>12-36866-01</b> 11 34 0 034 068</p>  <p><b>12-37256-01</b> 11 34 0 035 853</p> 	<p><b>11-37133-01</b> </p> <p>11 61 7 547 242</p>  <p><b>71-37134-00</b>  6x</p> <p>18 40 7 530 606</p> 	<p><b>71-41291-00</b> 11 13 7 600 482</p> 	<p><b>81-34057-00</b> </p> <p>11 11 7 547 842 65x79 A SL RD PTFE ACM  02/11</p>  <p><b>81-10378-00</b> </p> <p>11 11 8 618 864 65x79 RD FPM  03/11→</p>  <p><b>81-40292-00</b> </p> <p>11 11 7 587 168 90x110 A LD FPM</p> 
<p>3,0 N52 B30 A</p> <p>190 kW (258 PS)</p> <p>X3 (F25)</p> <p>01/11-10/12</p>		<p><b>02-37159-01</b> 11 12 7 571 963 +11 34 0 035 853</p> 			<p><b>61-36120-00</b> 11 12 7 548 797 85,5 Ø 1,2 mm MLS</p> <p><b>61-36120-10</b> 11 12 7 553 210 85,5 Ø 1,5 mm MLS</p> 	<p><b>14-32315-01</b> 11 12 7 548 799</p> 	<p><b>15-37159-01</b> 11 12 7 582 245</p> 	<p><b>12-36866-01</b> 11 34 0 034 068</p>  <p><b>12-37256-01</b> 11 34 0 035 853</p> 	<p><b>11-37133-01</b> </p> <p>11 61 7 547 242</p>  <p><b>71-37134-00</b>  6x</p> <p>18 40 7 530 606</p>  <p><b>71-37136-00</b>   2x</p> <p>18 10 7 549 447</p> 	<p><b>71-41291-00</b> 11 13 7 600 482</p> 	<p><b>81-10378-00</b> </p> <p>11 11 8 618 864 65x79 RD FPM</p>  <p><b>81-40292-00</b> </p> <p>11 11 7 587 168 90x110 A LD FPM</p> 











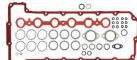

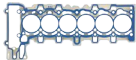





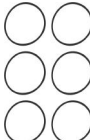

BMW



Ltr.  N52 B30 A 190 kW (258 PS) Z4 3.0si (E85)  01/06-08/08

















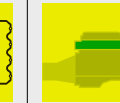
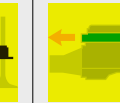
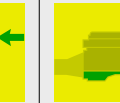
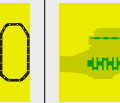
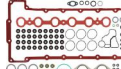
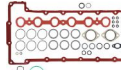

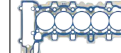

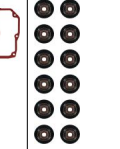
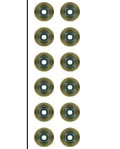

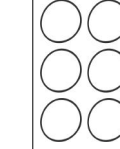





										
	<p><b>02-37289-01</b> 11 12 7 548 921 +11 34 0 035 853 +11 34 0 032 582  10/06</p>  <p><b>02-37289-02</b> 11 12 7 548 921  10/06</p>  <p><b>02-37159-01</b> 11 12 7 571 963 +11 34 0 035 853  11/06→</p> 	<p><b>08-38669-01</b> 11 11 7 548 101</p> 		<p><b>61-36120-00</b> 11 12 7 548 797 85,5 Ø 1,2 mm MLS</p> <p><b>61-36120-10</b> 11 12 7 553 210 85,5 Ø 1,5 mm MLS</p> 	<p><b>14-32315-01</b> 11 12 7 548 799</p> 	<p><b>15-37289-01</b> 11 12 7 581 215</p> 	<p><b>12-36866-02</b> 11 34 0 032 582  03/06</p>  <p><b>12-36866-01</b> 11 34 0 034 068  04/06→</p>  <p><b>12-37256-01</b> 11 34 0 035 853  04/06→</p> 	<p><b>11-37133-01</b> </p>  <p><b>71-37134-00</b>  6x</p>  <p><b>71-37136-00</b>   2x</p> 	<p><b>71-38669-00</b> 11 13 7 548 031</p> 	<p><b>81-34057-00</b> </p>  <p>11 11 7 547 842 65x79 A SL RD PTFE ACM</p> <p><b>81-37122-00</b> </p>  <p>11 11 7 584 398 90x110 A SL LD PTFE (Polytetrafluorethylen)/ACM (Polyacryl-Kautschuk)</p>

3,0 N52 B30 A 190 kW (258 PS) 330 i (E93)  03/10-10/13















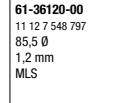
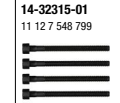
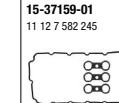
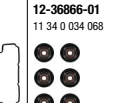
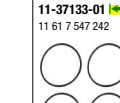
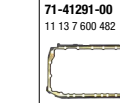
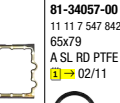

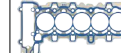

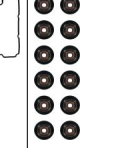
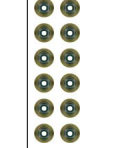

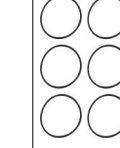



	<p><b>02-37289-02</b> 11 12 7 548 921</p> 	<p><b>08-38669-01</b> 11 11 7 548 101</p> 		<p><b>61-36120-00</b> 11 12 7 548 797 85,5 Ø 1,2 mm MLS</p> <p><b>61-36120-10</b> 11 12 7 553 210 85,5 Ø 1,5 mm MLS</p> 	<p><b>14-32315-01</b> 11 12 7 548 799</p> 	<p><b>15-37289-01</b> 11 12 7 581 215</p> 	<p><b>12-36866-01</b> 11 34 0 034 068</p>  <p><b>12-37256-01</b> 11 34 0 035 853</p> 	<p><b>11-37133-01</b> </p>  <p><b>71-37134-00</b>  6x</p>  <p><b>71-37136-00</b>   2x</p> 	<p><b>71-38669-00</b> 11 13 7 548 031</p> 	<p><b>81-34057-00</b> </p>  <p>11 11 7 547 842 65x79 A SL RD PTFE ACM</p> <p><b>81-37122-00</b> </p>  <p>11 11 7 584 398 90x110 A SL LD PTFE (Polytetrafluorethylen)/ACM (Polyacryl-Kautschuk)</p>
--	---	--	--	---	--	---	--	--	---	--

BMW



Ltr.  N52 B30 A 190 kW (258 PS) 530 i (F10)  03/10-06/13

















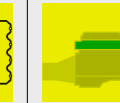
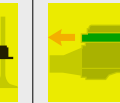
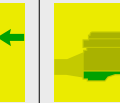
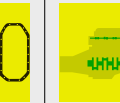
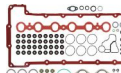
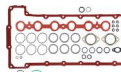

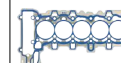

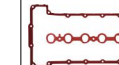
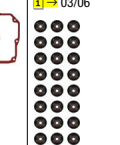
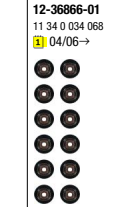
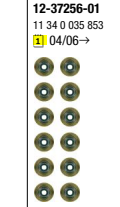

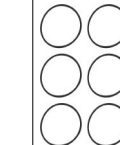



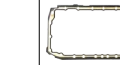
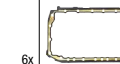

										
	<p><b>02-37289-01</b> 11 12 7 548 921 +11 34 0 035 853 +11 34 0 032 582</p>  <p><b>02-37289-02</b> 11 12 7 548 921</p> 	<p><b>08-38669-01</b> 11 11 7 548 101</p> 		<p><b>61-36120-00</b> 11 12 7 548 797 85,5 Ø 1,2 mm MLS</p> <p><b>61-36120-10</b> 11 12 7 553 210 85,5 Ø 1,5 mm MLS</p> 	<p><b>14-32315-01</b> 11 12 7 548 799</p> 	<p><b>15-37289-01</b> 11 12 7 581 215</p> 	<p><b>12-36866-01</b> 11 34 0 034 068</p>  <p><b>12-37256-01</b> 11 34 0 035 853</p> 	<p><b>11-37133-01</b>  </p>  <p><b>11-37134-00</b>  6x 18 40 7 530 606</p> <p><b>11-37136-00</b>   2x 18 10 7 549 447</p> 	<p><b>71-38669-00</b> 11 13 7 548 031</p>  <p><b>71-41291-00</b> 11 13 7 600 482</p> 	<p><b>81-34057-00</b> </p> <p>11 11 7 547 842 65x79 A SL RD PTFE ACM  02/11</p>  <p><b>81-10378-00</b> </p> <p>11 11 8 618 864 65x79 RD FPM  03/11→</p>  <p><b>81-37122-00</b> </p> <p>11 11 7 584 398 90x110 A SL LD PTFE (Polytetrafluorethylen)/ACM (Polyacryl-Kautschuk)</p>  <p><b>81-40292-00</b> </p> <p>11 11 7 587 168 90x110 A LD FPM</p> 

3,0 N52 B30 A 190 kW (258 PS) 530 i (F11) 03/10-05/13











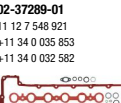

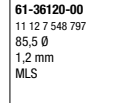
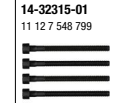
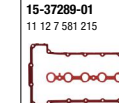
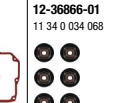
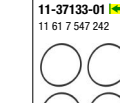
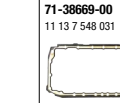
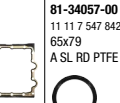
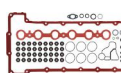
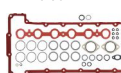

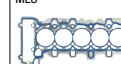

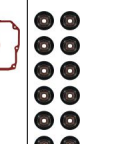
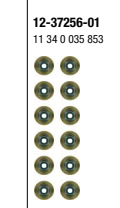

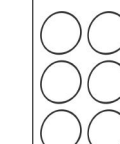

										
	<p><b>02-37159-01</b> 11 12 7 571 963 +11 34 0 035 853</p> 	<p><b>08-38669-01</b> 11 11 7 548 101</p> 		<p><b>61-36120-00</b> 11 12 7 548 797 85,5 Ø 1,2 mm MLS</p> <p><b>61-36120-10</b> 11 12 7 553 210 85,5 Ø 1,5 mm MLS</p> 	<p><b>14-32315-01</b> 11 12 7 548 799</p> 	<p><b>15-37159-01</b> 11 12 7 582 245</p> 	<p><b>12-36866-01</b> 11 34 0 034 068</p>  <p><b>12-37256-01</b> 11 34 0 035 853</p> 	<p><b>11-37133-01</b>  </p>  <p><b>11-37134-00</b>  6x 18 40 7 530 606</p> <p><b>11-37136-00</b>   2x 18 10 7 549 447</p> 	<p><b>71-41291-00</b> 11 13 7 600 482</p> 	<p><b>81-34057-00</b> </p> <p>11 11 7 547 842 65x79 A SL RD PTFE ACM  02/11</p>  <p><b>81-10378-00</b> </p> <p>11 11 8 618 864 65x79 RD FPM  03/11→</p>  <p><b>81-40292-00</b> </p> <p>11 11 7 587 168 90x110 A LD FPM</p> 

BMW

Ltr.  N52 B30 A 190 kW (258 PS) 730 Li (E65, E66)  03/05-08/08

















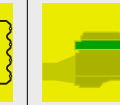
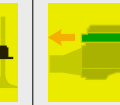
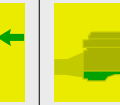



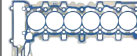

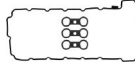
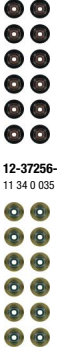

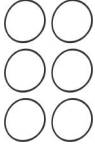

										
	<p><b>02-37289-01</b> 11 12 7 548 921 +11 34 0 035 853 +11 34 0 032 582</p>  <p><b>02-37289-02</b> 11 12 7 548 921</p> 	<p><b>08-38669-01</b> 11 11 7 548 101</p> 		<p><b>61-36120-00</b> 11 12 7 548 797 85,5 Ø 1,2 mm MLS</p> <p><b>61-36120-10</b> 11 12 7 553 210 85,5 Ø 1,5 mm MLS</p> 	<p><b>14-32315-01</b> 11 12 7 548 799</p> 	<p><b>15-37289-01</b> 11 12 7 581 215</p> 	<p><b>12-36866-02</b> 11 34 0 032 582 1 → 03/06</p>  <p><b>12-36866-01</b> 11 34 0 034 068 1 → 04/06 →</p>  <p><b>12-37256-01</b> 11 34 0 035 853 1 → 04/06 →</p> 	<p><b>11-37133-01</b>  6x 11 61 7 547 242</p>  <p><b>71-37134-00</b>  6x 18 40 7 530 606</p>  <p><b>71-37136-00</b>   2x 18 10 7 549 447</p> 	<p><b>71-38669-00</b> 11 13 7 548 031</p>  <p><b>71-41291-00</b> 11 13 7 600 482</p> 	<p><b>81-34057-00</b>   11 11 7 547 842 65x79 A SL RD PTFE ACM</p>  <p><b>81-37122-00</b>   11 11 7 584 398 90x110 A SL LD PTFE (Polytetrafluorethylen)/ACM (Polyacryl-Kautschuk)</p>  <p><b>81-40292-00</b>   11 11 7 587 168 90x110 A LD FPM</p> 

3,0 N52 B30 A 190-200 kW (258-272 PS) X3 3.0 si (E83) X5 3.0 si (E70) Z4 3.0 si (E86) 130i (E81, E87) 130i (E87) 330i (E92) 330 xi (E92) 04/06-06/13













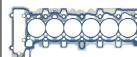

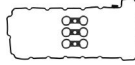
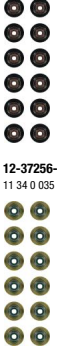

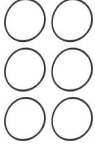



										
	<p><b>02-37289-01</b> 11 12 7 548 921 +11 34 0 035 853 +11 34 0 032 582</p>  <p><b>02-37289-02</b> 11 12 7 548 921</p> 	<p><b>08-38669-01</b> 11 11 7 548 101</p> 		<p><b>61-36120-00</b> 11 12 7 548 797 85,5 Ø 1,2 mm MLS</p> <p><b>61-36120-10</b> 11 12 7 553 210 85,5 Ø 1,5 mm MLS</p> 	<p><b>14-32315-01</b> 11 12 7 548 799</p> 	<p><b>15-37289-01</b> 11 12 7 581 215</p> 	<p><b>12-36866-01</b> 11 34 0 034 068</p>  <p><b>12-37256-01</b> 11 34 0 035 853</p> 	<p><b>11-37133-01</b>  6x 11 61 7 547 242</p>  <p><b>71-37134-00</b>  6x 18 40 7 530 606</p>  <p><b>71-37136-00</b>   2x 18 10 7 549 447</p> 	<p><b>71-38669-00</b> 11 13 7 548 031</p> 	<p><b>81-34057-00</b>   11 11 7 547 842 65x79 A SL RD PTFE ACM</p>  <p><b>81-37122-00</b>   11 11 7 584 398 90x110 A SL LD PTFE (Polytetrafluorethylen)/ACM (Polyacryl-Kautschuk)</p> 

BMW



Ltr.  N52 B30 A 194 kW (264 PS) X1 xDrive 28 i (E84) 03/10-06/11 

										
	<p><b>02-37159-01</b> 11 12 7 571 963 +11 34 0 035 853</p> 	<p><b>08-38669-01</b> 11 11 7 548 101</p> 		<p><b>61-36120-00</b> 11 12 7 548 797 85,5 Ø 1,2 mm MLS</p> <p><b>61-36120-10</b> 11 12 7 553 210 85,5 Ø 1,5 mm MLS</p> 	<p><b>14-32315-01</b> 11 12 7 548 799</p> 	<p><b>15-37159-01</b> 11 12 7 582 245</p> 	<p><b>12-36866-01</b> 11 34 0 034 068</p>  <p><b>12-37256-01</b> 11 34 0 035 853</p> 	<p><b>11-37133-01</b>  11 61 7 547 242</p>  <p><b>71-37134-00</b>  6x 18 40 7 530 606</p> 	<p><b>71-38669-00</b> 11 13 7 548 031</p> 	<p><b>81-34057-00</b>  11 11 7 547 842 65x79 A SL RD PTFE ACM  01/11</p>  <p><b>81-10378-00</b>  11 11 8 618 864 65x79 RD FPM  02/11→</p>  <p><b>81-40292-00</b>  11 11 7 587 168 90x110 A LD FPM</p> 

3,0 N52 B30 A 195 kW (265 PS) Z4 sDrive 30 i (E89) 05/09-08/11

	<p><b>02-37159-01</b> 11 12 7 571 963 +11 34 0 035 853</p> 	<p><b>08-38669-01</b> 11 11 7 548 101</p> 		<p><b>61-36120-00</b> 11 12 7 548 797 85,5 Ø 1,2 mm MLS</p> <p><b>61-36120-10</b> 11 12 7 553 210 85,5 Ø 1,5 mm MLS</p> 	<p><b>14-32315-01</b> 11 12 7 548 799</p> 	<p><b>15-37159-01</b> 11 12 7 582 245</p> 	<p><b>12-36866-01</b> 11 34 0 034 068</p>  <p><b>12-37256-01</b> 11 34 0 035 853</p> 	<p><b>11-37133-01</b>  11 61 7 547 242</p>  <p><b>71-37134-00</b>  18 40 7 530 606</p>  <p><b>71-37136-00</b>   18 10 7 549 447</p> 	<p><b>71-38669-00</b> 11 13 7 548 031</p> 	<p><b>81-10378-00</b>  11 11 8 618 864 65x79 RD FPM  02/11→</p>  <p><b>81-34057-00</b>  11 11 7 547 842 65x79 A SL RD PTFE ACM</p>  <p><b>81-40292-00</b>  11 11 7 587 168 90x110 A LD FPM</p> 
--	--	--	--	---	---	---	---	---	---	--

BMW

Ltr.  N52 B30 A 200 kW (272 PS) X3 3.0 i (E83)  09/08-08/10

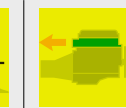

3,0 N52 B30 A 200 kW (272 PS) X3 3.0 i (E83) 09/08-08/10

02-37159-01 1x  
11 12 7 571 963  
+11 34 0 035 853



08-38669-01  
11 11 7 548 101

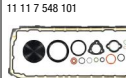

61-36120-00  
11 12 7 548 797  
85,5 Ø  
1,2 mm  
MLS

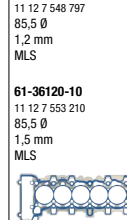

61-36120-10  
11 12 7 553 210  
85,5 Ø  
1,5 mm  
MLS

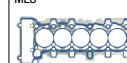

14-32315-01  
11 12 7 548 799

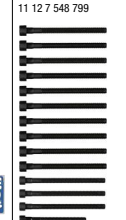

15-37159-01  
11 12 7 582 245

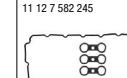

12-36866-01  
11 34 0 034 068



12-37256-01  
11 34 0 035 853

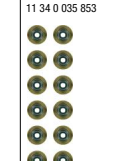

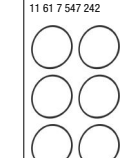

11-37133-01   
11 61 7 547 242



71-37134-00   
18 40 7 530 606



71-37136-00    
18 10 7 549 447



71-38669-00  
11 13 7 548 031



81-34057-00   
11 11 7 547 842  
65x79  
A SL RD PTFE ACM



81-37122-00   
11 11 7 584 398  
90x110  
A SL LD PTFE  
(Polytetrafluorethylen)/ACM  
(Polyacryl-Kautschuk)

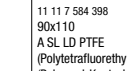

3,0 N52 B30 A 200 kW (272 PS) X5 3.0 i (E70) 10/08-03/10

02-37289-01  
11 12 7 548 921  
+11 34 0 035 853  
+11 34 0 032 582

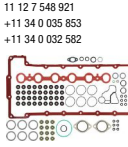

02-37289-02  
11 12 7 548 921

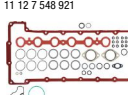

08-38669-01  
11 11 7 548 101



61-36120-00  
11 12 7 548 797  
85,5 Ø  
1,2 mm  
MLS

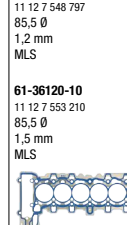

61-36120-10  
11 12 7 553 210  
85,5 Ø  
1,5 mm  
MLS



14-32315-01  
11 12 7 548 799

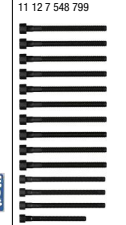

15-37159-01  
11 12 7 582 245



12-36866-01  
11 34 0 034 068



12-37256-01  
11 34 0 035 853

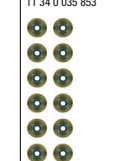

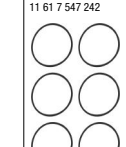

11-37133-01   
11 61 7 547 242



71-37134-00  6x  
18 40 7 530 606



71-37136-00   2x  
18 10 7 549 447



71-38669-00  
11 13 7 548 031



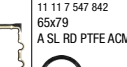

81-34057-00   
11 11 7 547 842  
65x79  
A SL RD PTFE ACM

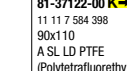

81-37122-00   
11 11 7 584 398  
90x110  
A SL LD PTFE  
(Polytetrafluorethylen)/ACM  
(Polyacryl-Kautschuk)  
 01/09





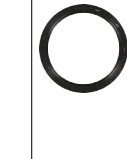
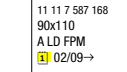











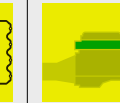
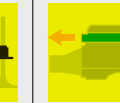
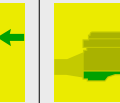
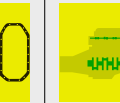
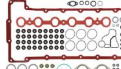
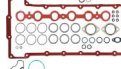

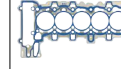

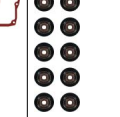
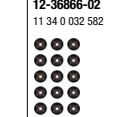
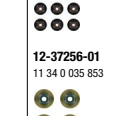

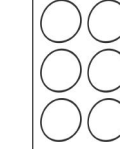





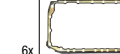

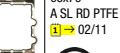



81-40292-00   
11 11 7 587 168  
90x110  
A LD FPM  
 02/09 →













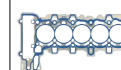

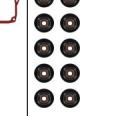
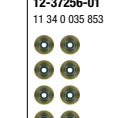

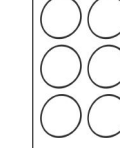





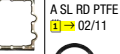

BMW

Ltr.  N52 B30 A 200 kW (272 PS) 330 i (E90) 03/07-12/11

										
	<p><b>02-37289-01</b> 11 12 7 548 921 +11 34 0 035 853 +11 34 0 032 582</p>  <p><b>02-37289-02</b> 11 12 7 548 921</p> 	<p><b>08-38669-01</b> 11 11 7 548 101</p> 		<p><b>61-36120-00</b> 11 12 7 548 797 85,5 Ø 1,2 mm MLS</p> <p><b>61-36120-10</b> 11 12 7 553 210 85,5 Ø 1,5 mm MLS</p> 	<p><b>14-32315-01</b> 11 12 7 548 799</p> 	<p><b>15-37289-01</b> 11 12 7 581 215</p> 	<p><b>12-36866-01</b> 11 34 0 034 068</p>  <p><b>12-36866-02</b> 11 34 0 032 582</p>  <p><b>12-37256-01</b> 11 34 0 035 853</p> 	<p><b>11-37133-01</b>  </p>  <p><b>71-37134-00</b>  6x</p>  <p><b>71-37136-00</b>   2x</p> 	<p><b>71-38669-00</b> 11 13 7 548 031</p>  <p><b>71-41291-00</b> 11 13 7 600 482</p> 	<p><b>81-34057-00</b> </p>  <p>11 11 7 547 842 65x79 A SL RD PTFE ACM  02/11</p> <p><b>81-10378-00</b> </p>  <p>11 11 8 618 864 65x79 RD FPM  03/11 →</p> <p><b>81-37122-00</b> </p>  <p>11 11 7 584 398 90x110 A SL LD PTFE (Polytetrafluorethylen)/ACM (Polyacryl-Kautschuk)  01/09</p> <p><b>81-40292-00</b> </p>  <p>11 11 7 587 168 90x110 A LD FPM  02/09 →</p> 

3,0 N52 B30 A 200 kW (272 PS) 330 i (E91) 03/07-06/12

















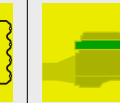
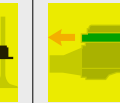
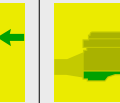
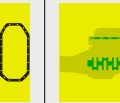
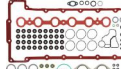
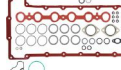

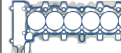





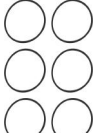







	<p><b>02-37289-01</b> 11 12 7 548 921 +11 34 0 035 853 +11 34 0 032 582</p> 	<p><b>08-38669-01</b> 11 11 7 548 101</p> 		<p><b>61-36120-00</b> 11 12 7 548 797 85,5 Ø 1,2 mm MLS</p> <p><b>61-36120-10</b> 11 12 7 553 210 85,5 Ø 1,5 mm MLS</p> 	<p><b>14-32315-01</b> 11 12 7 548 799</p> 	<p><b>15-37289-01</b> 11 12 7 581 215</p> 	<p><b>12-36866-01</b> 11 34 0 034 068</p>  <p><b>12-37256-01</b> 11 34 0 035 853</p> 	<p><b>11-37133-01</b>  </p>  <p><b>71-37134-00</b>  6x</p>  <p><b>71-37136-00</b>   2x</p> 	<p><b>71-38669-00</b> 11 13 7 548 031</p> 	<p><b>81-34057-00</b> </p>  <p>11 11 7 547 842 65x79 A SL RD PTFE ACM  02/11</p> <p><b>81-10378-00</b> </p>  <p>11 11 8 618 864 65x79 RD FPM  03/11 →</p> <p><b>81-37122-00</b> </p>  <p>11 11 7 584 398 90x110 A SL LD PTFE (Polytetrafluorethylen)/ACM (Polyacryl-Kautschuk)  01/09</p> 
--	---	---	--	---	--	--	---	--	--	--

BMW











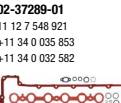

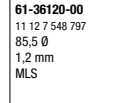
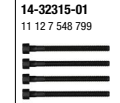
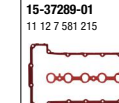
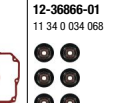
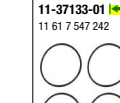
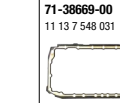
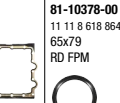

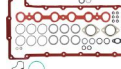

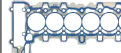
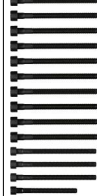

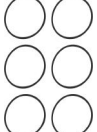

BMW														
Ltr.														
3,0	N52 B30 A	200 kW (272 PS)	330 i (E93)	03/07-02/10										
			<b>1</b>		<p><b>02-37159-01</b> 11 12 7 571 963 +11 34 0 035 853</p>	<p><b>08-38669-01</b> 11 11 7 548 101</p>	<p><b>61-36120-00</b> 11 12 7 548 797 85,5 Ø 1,2 mm MLS</p> <p><b>61-36120-10</b> 11 12 7 553 210 85,5 Ø 1,5 mm MLS</p>	<p><b>14-32315-01</b> 11 12 7 548 799</p>	<p><b>15-37289-01</b> 11 12 7 581 215 1 → 02/10</p>	<p><b>12-36866-01</b> 11 34 0 034 068</p> <p><b>12-37256-01</b> 11 34 0 035 853</p>	<p><b>11-37133-01</b> </p> <p>11 61 7 547 242</p> <p><b>71-37134-00</b> </p> <p>18 40 7 530 606</p>	<p><b>71-38669-00</b> 11 13 7 548 031</p>	<p><b>81-34057-00</b> </p> <p>11 11 7 547 842 65x79 A SL RD PTFE ACM</p> <p><b>81-40292-00</b> </p> <p>11 11 7 587 168 90x110 A LD FPM</p>	
3,0	N52 B30 A	200 kW (272 PS)	330 xi (E92)	09/06-08/07	<p><b>02-37159-01</b> 11 12 7 571 963 +11 34 0 035 853</p>	<p><b>08-38669-01</b> 11 11 7 548 101</p>	<p><b>61-36120-00</b> 11 12 7 548 797 85,5 Ø 1,2 mm MLS</p> <p><b>61-36120-10</b> 11 12 7 553 210 85,5 Ø 1,5 mm MLS</p>	<p><b>14-32315-01</b> 11 12 7 548 799</p>	<p><b>15-37289-01</b> 11 12 7 581 215</p>	<p><b>12-36866-01</b> 11 34 0 034 068</p> <p><b>12-37256-01</b> 11 34 0 035 853</p>	<p><b>11-37133-01</b> </p> <p>11 61 7 547 242</p> <p><b>71-37134-00</b> </p> <p>18 40 7 530 606</p>	<p><b>71-38669-00</b> 11 13 7 548 031</p>	<p><b>81-10378-00</b> </p> <p>11 11 8 618 864 65x79 RD FPM</p> <p><b>81-34057-00</b> </p> <p>11 11 7 547 842 65x79 A SL RD PTFE ACM</p> <p><b>81-40292-00</b> </p> <p>11 11 7 587 168 90x110 A LD FPM</p>	

BMW

Ltr.  N52 B30 A 200 kW (272 PS) 530 i (E60) 03/07-12/09



													
3,0	N52 B30 A	200 kW (272 PS)	530 i (E60)	03/07-12/09	<p><b>02-37289-01</b> 11 12 7 548 921 +11 34 0 035 853 +11 34 0 032 582</p>  <p><b>02-37289-02</b> 11 12 7 548 921</p> 	<p><b>08-38669-01</b> 11 11 7 548 101</p> 	<p><b>61-36120-00</b> 11 12 7 548 797 85,5 Ø 1,2 mm MLS</p> <p><b>61-36120-10</b> 11 12 7 553 210 85,5 Ø 1,5 mm MLS</p> 	<p><b>14-32315-01</b> 11 12 7 548 799</p> 	<p><b>15-37289-01</b> 11 12 7 581 215</p> 	<p><b>12-36866-01</b> 11 34 0 034 068</p>  <p><b>12-36866-02</b> 11 34 0 032 582</p>  <p><b>12-37256-01</b> 11 34 0 035 853</p> 	<p><b>11-37133-01</b> </p> <p>11 61 7 547 242</p>  <p><b>71-37134-00</b>  6x</p> <p>18 40 7 530 606</p>  <p><b>71-37136-00</b>   2x</p> <p>18 10 7 549 447</p> 	<p><b>71-38669-00</b> 11 13 7 548 031</p>  <p><b>71-41291-00</b> 11 13 7 600 482</p> 	<p><b>81-10378-00</b> </p> <p>11 11 8 618 864 65x79 RD FPM</p>  <p><b>81-34057-00</b> </p> <p>11 11 7 547 842 65x79 A SL RD PTFE ACM</p>  <p><b>81-37122-00</b> </p> <p>11 11 7 584 398 90x110 A SL LD PTFE (Polytetrafluorethylen)/ACM (Polyacryl-Kautschuk)  01/09</p>  <p><b>81-40292-00</b> </p> <p>11 11 7 587 168 90x110 A LD FPM  02/09 →</p> 

3,0 N52 B30 A 200 kW (272 PS) 530 i (E61) 530 xi (E60) 09/06-03/10

													
3,0	N52 B30 A	200 kW (272 PS)	530 i (E61) 530 xi (E60)	09/06-03/10	<p><b>02-37289-01</b> 11 12 7 548 921 +11 34 0 035 853 +11 34 0 032 582</p>  <p><b>02-37289-02</b> 11 12 7 548 921</p> 	<p><b>08-38669-01</b> 11 11 7 548 101</p> 	<p><b>61-36120-00</b> 11 12 7 548 797 85,5 Ø 1,2 mm MLS</p> <p><b>61-36120-10</b> 11 12 7 553 210 85,5 Ø 1,5 mm MLS</p> 	<p><b>14-32315-01</b> 11 12 7 548 799</p> 	<p><b>15-37289-01</b> 11 12 7 581 215</p> 	<p><b>12-36866-01</b> 11 34 0 034 068</p>  <p><b>12-37256-01</b> 11 34 0 035 853</p> 	<p><b>11-37133-01</b> </p> <p>11 61 7 547 242</p>  <p><b>71-37134-00</b> </p> <p>18 40 7 530 606</p> 	<p><b>71-38669-00</b> 11 13 7 548 031</p> 	<p><b>81-10378-00</b> </p> <p>11 11 8 618 864 65x79 RD FPM</p>  <p><b>81-34057-00</b> </p> <p>11 11 7 547 842 65x79 A SL RD PTFE ACM</p>  <p><b>81-40292-00</b> </p> <p>11 11 7 587 168 90x110 A LD FPM</p> 



BMW

Ltr.  3,0 N52 B30 A 200 kW (272 PS)  630 i (E63) 630 i (E64)  09/07-08/10 **1**

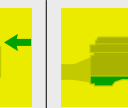
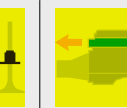
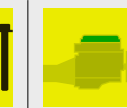

3,0 N52 B30 AE 179 kW (243 PS)

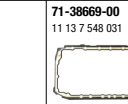
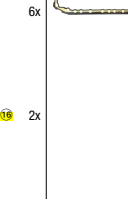
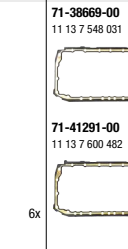
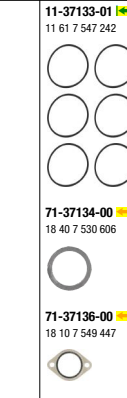
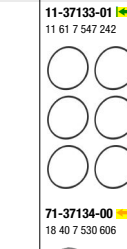
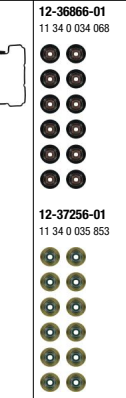
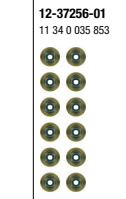
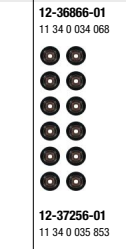
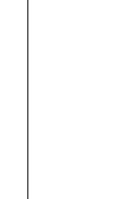
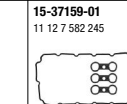
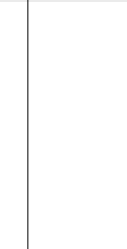
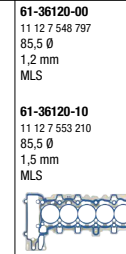
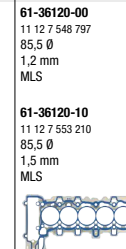
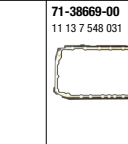
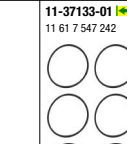
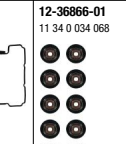
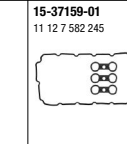
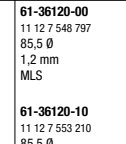
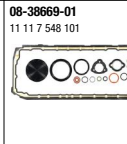

**08-38669-01**  
11 11 7 548 101

**08-38669-01**  
11 11 7 548 101

**61-36120-00**  
11 12 7 548 797  
85,5 Ø  
1,2 mm  
MLS

**61-36120-10**  
11 12 7 553 210  
85,5 Ø  
1,5 mm  
MLS

**61-36120-00**  
11 12 7 548 797  
85,5 Ø  
1,2 mm  
MLS

**61-36120-10**  
11 12 7 553 210  
85,5 Ø  
1,5 mm  
MLS

**14-32315-01**  
11 12 7 548 799



**14-32315-01**  
11 12 7 548 799



**12-36866-01**  
11 34 0 034 068



**12-36866-01**  
11 34 0 034 068



**12-37256-01**  
11 34 0 035 853



**12-37256-01**  
11 34 0 035 853



**11-37133-01**    
11 61 7 547 242

**11-37133-01**    
11 61 7 547 242

**71-37134-00**   6x  
18 40 7 530 606

**71-37134-00**   6x  
18 40 7 530 606

**71-37136-00**   2x  
18 10 7 549 447

**71-37136-00**   2x  
18 10 7 549 447

**71-38669-00**  
11 13 7 548 031

**71-38669-00**  
11 13 7 548 031

**81-34057-00**    
11 11 7 547 842  
65x79  
A SL RD PTFE ACM

**81-34057-00**    
11 11 7 547 842  
65x79  
A SL RD PTFE ACM















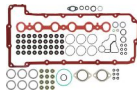



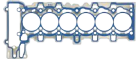



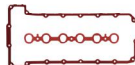

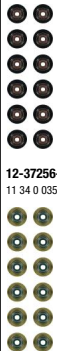



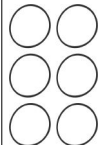























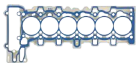

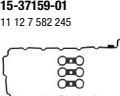

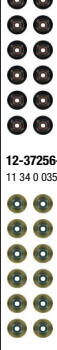
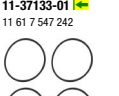

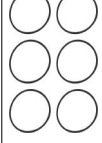



**81-37122-00**    
11 11 7 584 398  
90x110  
A SL LD PTFE  
(Polytetrafluorethylen)/ACM  
(Polyacryl-Kautschuk)

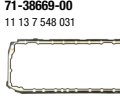















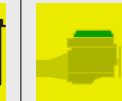

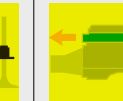











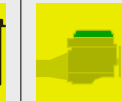
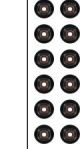
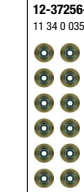
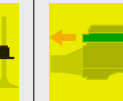

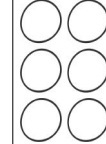









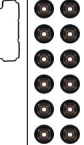
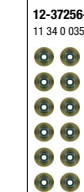

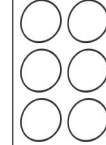













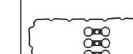
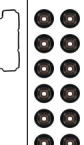
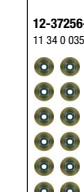

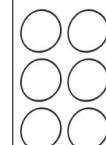

**81-37122-00**    
11 11 7 584 398  
90x110  
A SL LD PTFE  
(Polytetrafluorethylen)/ACM  
(Polyacryl-Kautschuk)

**81-40292-00**    
11 11 7 587 168  
90x110  
A LD FPM

**81-40292-00**    
11 11 7 587 168  
90x110  
A LD FPM

BMW

<p>Ltr.  N52 B30 AF</p> <p>190-195 kW (258-265 PS)</p> <p>130 i (E87) 530 i (F10) 730 i (F01, F02)</p> <p>09/05-06/15</p> <p></p>		 <p><b>02-37289-01</b> 11 12 7 548 921 +11 34 0 035 853 +11 34 0 032 582</p> 	 <p><b>08-38669-01</b> 11 11 7 548 101</p> 		 <p><b>61-36120-00</b> 11 12 7 548 797 85,5 Ø 1,2 mm MLS</p> <p><b>61-36120-10</b> 11 12 7 553 210 85,5 Ø 1,5 mm MLS</p> 	 <p><b>14-32315-01</b> 11 12 7 548 799</p> 	 <p><b>15-37289-01</b> 11 12 7 581 215</p> 	 <p><b>12-36866-01</b> 11 34 0 034 068</p> 	 <p><b>11-37133-01</b>   11 61 7 547 242</p>  <p><b>71-37134-00</b>  6x 18 40 7 530 606</p>  <p><b>71-37136-00</b>   2x 18 10 7 549 447</p> 	 <p><b>71-38669-00</b> 11 13 7 548 031</p> 	 <p><b>81-34057-00</b>   11 11 7 547 842 65x79 A SL RD PTFE ACM</p>  <p><b>81-37122-00</b>   11 11 7 584 398 90x110 A SL LD PTFE (Polytetrafluorethylen)/ACM (Polyacryl-Kautschuk)</p>  <p><b>81-40292-00</b>   11 11 7 587 168 90x110 A LD FPM</p> 
<p>3,0 N52 B30 B</p> <p>160-195 kW (218-265 PS)</p> <p>Z4 3.0 i (E89) 125 i (E82) 125 i (E88) 130 i (E81, E87) 130 i (E87)</p> <p>09/06-10/13</p>		 <p><b>02-37159-01</b> 11 12 7 571 963 +11 34 0 035 853</p> 	 <p><b>08-38669-01</b> 11 11 7 548 101</p> 		 <p><b>61-36120-00</b> 11 12 7 548 797 85,5 Ø 1,2 mm MLS</p> <p><b>61-36120-10</b> 11 12 7 553 210 85,5 Ø 1,5 mm MLS</p> 	 <p><b>14-32315-01</b> 11 12 7 548 799</p> 	 <p><b>15-37159-01</b> 11 12 7 582 245</p> 	 <p><b>12-36866-01</b> 11 34 0 034 068</p> 	 <p><b>11-37133-01</b>   11 61 7 547 242</p>  <p><b>71-37134-00</b>  6x 18 40 7 530 606</p>  <p><b>71-37136-00</b>   2x 18 10 7 549 447</p> 	 <p><b>71-38669-00</b> 11 13 7 548 031</p> 	 <p><b>81-34057-00</b>   11 11 7 547 842 65x79 A SL RD PTFE ACM</p>  <p><b>81-37122-00</b>   11 11 7 584 398 90x110 A SL LD PTFE (Polytetrafluorethylen)/ACM (Polyacryl-Kautschuk)</p> 

BMW															
Ltr.															
3,0	N52 B30 B	200 kW (272 PS)	09/07-08/10			08-38669-01 11 11 7 548 101 		61-36120-00 11 12 7 548 797 85,5 Ø 1,2 mm MLS  61-36120-10 11 12 7 553 210 85,5 Ø 1,5 mm MLS 	14-32315-01 11 12 7 548 799 		12-36866-01 11 34 0 034 068   12-37256-01 11 34 0 035 853 		11-37133-01  11 61 7 547 242   71-37134-00  6x 18 40 7 530 606   71-37136-00   2x 18 10 7 549 447 	71-38669-00 11 13 7 548 031 	
3,0	N52 B30 BF	190-200 kW (258-272 PS)	03/05-08/10	X3 3.0 i (E83) X3 3.0 si (E83) 130 i (E87) 730 i Li (E65, E66)	02-37159-01 11 12 7 571 963 +11 34 0 035 853 			61-36120-00 11 12 7 548 797 85,5 Ø 1,2 mm MLS  61-36120-10 11 12 7 553 210 85,5 Ø 1,5 mm MLS 	14-32315-01 11 12 7 548 799 	15-37159-01 11 12 7 582 245 	12-36866-01 11 34 0 034 068   12-37256-01 11 34 0 035 853 	11-37133-01  11 61 7 547 242   71-37134-00  6x 18 40 7 530 606   71-37136-00   2x 18 10 7 549 447 	71-41291-00 11 13 7 600 482 	81-34057-00  11 11 7 547 842 65x79 A SL RD PTFE ACM   81-40292-00  11 11 7 587 168 90x110 A LD FPM 	
3,0	N52 B30 BF	200 kW (272 PS)	03/07-12/09	530 i (E60)	02-37159-01 11 12 7 571 963 +11 34 0 035 853 			61-36120-00 11 12 7 548 797 85,5 Ø 1,2 mm MLS  61-36120-10 11 12 7 553 210 85,5 Ø 1,5 mm MLS 	14-32315-01 11 12 7 548 799 	15-37159-01 11 12 7 582 245 	12-36866-01 11 34 0 034 068   12-37256-01 11 34 0 035 853 	11-37133-01  11 61 7 547 242   71-37134-00  6x 18 40 7 530 606   71-37136-00   2x 18 10 7 549 447 	71-41291-00 11 13 7 600 482 	81-10378-00  11 11 8 618 864 65x79 RD FPM   81-34057-00  11 11 7 547 842 65x79 A SL RD PTFE ACM   81-40292-00  11 11 7 587 168 90x110 A LD FPM 	

BMW

Ltr.	Motor	Power	Models	Year	Image 1	Image 2	Image 3	Image 4	Image 5	Image 6	Image 7	Image 8	Image 9	Image 10	Image 11	Image 12
3,0	N52 B30 BF	200 kW (272 PS)	630 i (E63) 630 i (E64)	09/07-08/10												
								<p><b>61-36120-00</b> 11 12 7 548 797 85,5 Ø 1,2 mm MLS</p> <p><b>61-36120-10</b> 11 12 7 553 210 85,5 Ø 1,5 mm MLS</p>				<p><b>12-36866-01</b> 11 34 0 034 068</p> <p><b>12-37256-01</b> 11 34 0 035 853</p>	<p><b>11-37133-01</b> </p> <p><b>11-37134-00</b> 6x 18 40 7 530 606</p> <p><b>11-37136-00</b>   2x 18 10 7 549 447</p>	<p><b>71-41291-00</b> 11 13 7 600 482</p>	<p><b>81-34057-00</b> </p> <p>11 11 7 547 842 65x79 A SL RD PTFE ACM</p> <p><b>81-40292-00</b> </p> <p>11 11 7 587 168 90x110 A LD FPM</p>	
3,0	N53 B30 N53 B30 A	155-200 kW (211-272 PS)	325 i (E90) 325 i (E91) 325 i (E92) 325 i (E93) 325 xi (E91) 325 xi (E92) 330 i (E90) 330 i (E92) 330 xi (E90) 330 xi (E91) 525 i (E60) 525 i (E61) 525 xi (E60)	10/06		<p><b>02-39286-01</b> 11 12 7 561 438</p>	<p><b>08-38669-01</b> 11 11 7 548 101</p>	<p><b>61-36120-00</b> 11 12 7 548 797 85,5 Ø 1,2 mm MLS</p> <p><b>61-36120-10</b> 11 12 7 553 210 85,5 Ø 1,5 mm MLS</p>	<p><b>14-32315-01</b> 11 12 7 548 799</p>	<p><b>71-39286-00</b> 11 12 7 544 368</p>	<p><b>12-36866-01</b> 11 34 0 034 068</p> <p><b>12-37256-01</b> 11 34 0 035 853</p>	<p><b>11-37133-01</b> </p> <p><b>11-37134-00</b> 6x 18 40 7 530 606</p> <p><b>11-37136-00</b>   2x 18 10 7 549 447</p>	<p><b>71-38669-00</b> 11 13 7 548 031</p>	<p><b>81-34057-00</b> </p> <p>11 11 7 547 842 65x79 A SL RD PTFE ACM</p> <p><b>81-37122-00</b> </p> <p>11 11 7 584 398 90x110 A SL LD PTFE (Polytetrafluorethylen)/ACM (Polyacryl-Kautschuk)</p>		
3,0	N53 B30 A	150-190 kW (204-258 PS)	523 i (F10) 523 i (F11) 528 i (F11)	06/09-08/11		<p><b>02-39286-01</b> 11 12 7 561 438</p>		<p><b>61-36120-00</b> 11 12 7 548 797 85,5 Ø 1,2 mm MLS</p> <p><b>61-36120-10</b> 11 12 7 553 210 85,5 Ø 1,5 mm MLS</p>	<p><b>14-32315-01</b> 11 12 7 548 799</p>	<p><b>71-39286-00</b> 11 12 7 544 368</p>	<p><b>12-36866-01</b> 11 34 0 034 068</p> <p><b>12-37256-01</b> 11 34 0 035 853</p>	<p><b>11-37133-01</b> </p> <p><b>11-37134-00</b> 6x 18 40 7 530 606</p> <p><b>11-37136-00</b>   2x 18 10 7 549 447</p>	<p><b>71-41291-00</b> 11 13 7 600 482</p>	<p><b>81-34057-00</b> </p> <p>11 11 7 547 842 65x79 A SL RD PTFE ACM  02/11</p> <p><b>81-10378-00</b> </p> <p>11 11 8 618 864 65x79 RD FPM  03/11→</p> <p><b>81-40292-00</b> </p> <p>11 11 7 587 168 90x110 A LD FPM</p>		

BMW

Ltr.  3,0 N53 B30 A 155 kW (211 PS) 325i (E90)  03/07-12/11

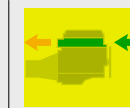

**02-39286-01**  
11 12 7 561 438



**61-36120-00**  
11 12 7 548 797  
85,5 Ø  
1,2 mm  
MLS

**61-36120-10**  
11 12 7 553 210  
85,5 Ø  
1,5 mm  
MLS

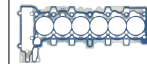

**14-32315-01**  
11 12 7 548 799

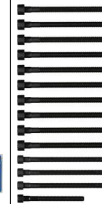

**71-39286-00**  
11 12 7 544 368

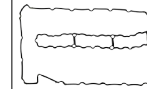

**12-36866-01**  
11 34 0 034 068



**12-37256-01**  
11 34 0 035 853

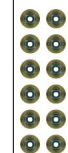

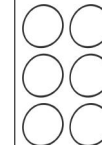

**11-37133-01**   
11 61 7 547 242



**71-37134-00**  6x  
18 40 7 530 606





**71-37136-00**    
18 10 7 549 447





**71-38669-00**  
11 13 7 548 031





**81-34057-00**   
11 11 7 547 842  
65x79  
A SL RD PTFE/ACM  
 02/11



**81-10378-00**   
11 11 8 618 864  
65x79  
RD FPM  
 03/11 →





**81-37122-00**   
11 11 7 584 398  
90x110  
A SL LD PTFE  
(Polytetrafluorethylen)/ACM  
(Polyacryl-Kautschuk)  
 01/09

















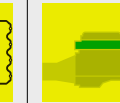
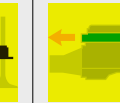
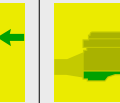
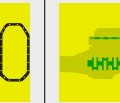

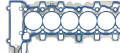

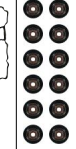
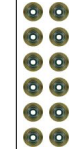

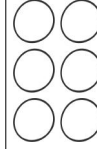











**81-40292-00**   
11 11 7 587 168  
90x110  
A LD FPM













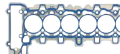



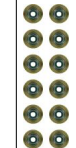

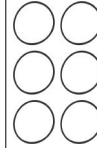









BMW

Ltr.  3,0 N53 B30 A 155 kW (211 PS) 523i (F10)  01/10-08/11  1

										
	<p><b>02-39286-01</b> 11 12 7 561 438</p> 	<p><b>08-38669-01</b> 11 11 7 548 101</p> 		<p><b>61-36120-00</b> 11 12 7 548 797 85,5 Ø 1,2 mm MLS</p> <p><b>61-36120-10</b> 11 12 7 553 210 85,5 Ø 1,5 mm MLS</p> 	<p><b>14-32315-01</b> 11 12 7 548 799</p> 	<p><b>71-39286-00</b> 11 12 7 544 368</p> 	<p><b>12-36866-01</b> 11 34 0 034 068</p>  <p><b>12-37256-01</b> 11 34 0 035 853</p> 	<p><b>11-37133-01</b>  </p>  <p><b>11-37134-00</b>  6x 18 40 7 530 606</p> <p><b>11-37136-00</b>   2x 18 10 7 549 447</p>  	<p><b>71-41291-00</b> 11 13 7 600 482</p> 	<p><b>81-34057-00</b>  </p> <p>11 11 7 547 842 65x79 A SL RD PTFE ACM  02/11</p>  <p><b>81-10378-00</b>  </p> <p>11 11 8 618 864 65x79 RD FPM  03/11→</p>  <p><b>81-37122-00</b>  </p> <p>11 11 7 584 398 90x110 A SL LD PTFE (Polytetrafluorethylen)/ACM (Polyacryl-Kautschuk)</p>  <p><b>81-40292-00</b>  </p> <p>11 11 7 587 168 90x110 A LD FPM</p> 

















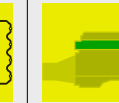
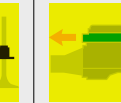
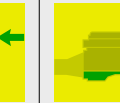

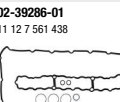

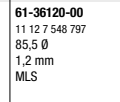
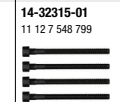

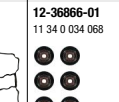

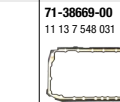
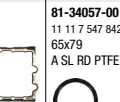
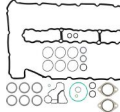

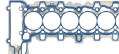

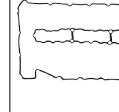

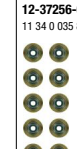









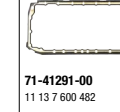







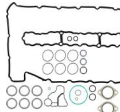

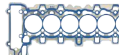

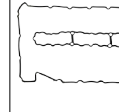
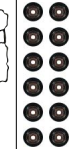
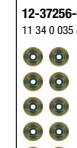





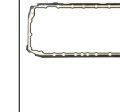

3,0 N53 B30 A 155-160 kW (211-218 PS) 320 d (E92) 325i (E91) 325i (E92) 325i (E93) 03/07-12/13

	<p><b>02-39286-01</b> 11 12 7 561 438</p> 	<p><b>08-38669-01</b> 11 11 7 548 101</p> 		<p><b>61-36120-00</b> 11 12 7 548 797 85,5 Ø 1,2 mm MLS</p> <p><b>61-36120-10</b> 11 12 7 553 210 85,5 Ø 1,5 mm MLS</p> 	<p><b>14-32315-01</b> 11 12 7 548 799</p> 	<p><b>71-39286-00</b> 11 12 7 544 368</p> 	<p><b>12-36866-01</b> 11 34 0 034 068</p>  <p><b>12-37256-01</b> 11 34 0 035 853</p> 	<p><b>11-37133-01</b>  </p>  <p><b>11-37134-00</b>  6x 18 40 7 530 606</p> <p><b>11-37136-00</b>   2x 18 10 7 549 447</p>  	<p><b>71-38669-00</b> 11 13 7 548 031</p> 	<p><b>81-34057-00</b>  </p> <p>11 11 7 547 842 65x79 A SL RD PTFE ACM  02/11</p>  <p><b>81-10378-00</b>  </p> <p>11 11 8 618 864 65x79 RD FPM  03/11→</p>  <p><b>81-37122-00</b>  </p> <p>11 11 7 584 398 90x110 A SL LD PTFE (Polytetrafluorethylen)/ACM (Polyacryl-Kautschuk)</p> 
--	--	---	--	---	--	--	--	--	---	--

BMW

Ltr.	Motor	Power	Models	Year	Image 1	Image 2	Image 3	Image 4	Image 5	Image 6	Image 7	Image 8	Image 9	Image 10	Image 11	Image 12
3,0	N53 B30 A	155-200 kW (211-272 PS)	325i xDrive (E90) 325i xDrive (E91) 325i xDrive (E92) 330i (E93)	03/07-10/13												
						<b>02-39286-01</b> 11 12 7 561 438 	<b>08-38669-01</b> 11 11 7 548 101 		<b>61-36120-00</b> 11 12 7 548 797 85,5 Ø 1,2 mm MLS  <b>61-36120-10</b> 11 12 7 553 210 85,5 Ø 1,5 mm MLS 	<b>14-32315-01</b> 11 12 7 548 799 	<b>71-39286-00</b> 11 12 7 544 368 	<b>12-36866-01</b> 11 34 0 034 068   <b>12-37256-01</b> 11 34 0 035 853 	<b>11-37133-01</b> 11 61 7 547 242   <b>71-37134-00</b> 6x 18 40 7 530 606  <b>71-37136-00</b> 2x 18 10 7 549 447 	<b>71-38669-00</b> 11 13 7 548 031 	<b>81-34057-00</b> 11 11 7 547 842 65x79 A SL RD PTFE ACM  <b>81-10378-00</b> 11 11 8 618 864 65x79 RD FPM  <b>81-37122-00</b> 11 11 7 584 398 90x110 A SL LD PTFE (Polytetrafluorethylen)/ACM (Polyacryl-Kautschuk)  <b>81-40292-00</b> 11 11 7 587 168 90x110 A LD FPM 	
3,0	N53 B30 A	155-200 kW (211-272 PS)	325i xDrive (E91) 525i (E60) 525i (E61) 530i (E61) 630i (E63) 630i (E64)	01/07-12/10					<b>61-36120-00</b> 11 12 7 548 797 85,5 Ø 1,2 mm MLS  <b>61-36120-10</b> 11 12 7 553 210 85,5 Ø 1,5 mm MLS 	<b>14-32315-01</b> 11 12 7 548 799 	<b>71-39286-00</b> 11 12 7 544 368 	<b>12-36866-01</b> 11 34 0 034 068   <b>12-37256-01</b> 11 34 0 035 853 	<b>11-37133-01</b> 11 61 7 547 242   <b>71-37134-00</b> 6x 18 40 7 530 606  <b>71-37136-00</b> 2x 18 10 7 549 447 	<b>71-38669-00</b> 11 13 7 548 031 	<b>81-34057-00</b> 11 11 7 547 842 65x79 A SL RD PTFE ACM  <b>81-37122-00</b> 11 11 7 584 398 90x110 A SL LD PTFE (Polytetrafluorethylen)/ACM (Polyacryl-Kautschuk)  <b>81-40292-00</b> 11 11 7 587 168 90x110 A LD FPM 	





















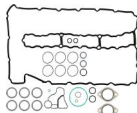

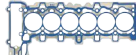





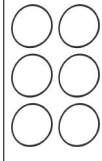







BMW

Ltr.		1													
3,0	N53 B30 A	155-200 kW (211-272 PS)	325 xi (E90) 325 xi (E92) 330 xi (E60) 525 i (E60) 530 xi (E60)	01/07-03/10											
3,0	N53 B30 A	160-200 kW (218-272 PS)	525 xi (E61) 530 i (E60) 530 i (E61)	01/07-12/10											
					<p><b>02-39286-01</b> 11 12 7 561 438</p> 	<p><b>08-38669-01</b> 11 11 7 548 101</p> 		<p><b>61-36120-00</b> 11 12 7 548 797 85,5 Ø 1,2 mm MLS</p> <p><b>61-36120-10</b> 11 12 7 553 210 85,5 Ø 1,5 mm MLS</p> 	<p><b>14-32315-01</b> 11 12 7 548 799</p> 	<p><b>71-39286-00</b> 11 12 7 544 368</p> 	<p><b>12-36866-01</b> 11 34 0 034 068</p>  <p><b>12-37256-01</b> 11 34 0 035 853</p> 	<p><b>11-37133-01</b> </p> <p>11 61 7 547 242</p>    <p><b>71-37134-00</b>  6x</p> <p>18 40 7 530 606</p>  <p><b>71-37136-00</b>   2x</p> <p>18 10 7 549 447</p> 	<p><b>71-38669-00</b> 11 13 7 548 031</p>  <p><b>71-41291-00</b> 11 13 7 600 482</p> 	<p><b>81-34057-00</b> </p> <p>11 11 7 547 842 65x79 A SL RD PTFE ACM</p>  <p><b>81-37122-00</b> </p> <p>11 11 7 584 398 90x110 A SL LD PTFE (Polytetrafluorethylen)/ACM (Polyacryl-Kautschuk)</p>  <p><b>81-40292-00</b> </p> <p>11 11 7 587 168 90x110 A LD FPM</p> 	
					<p><b>02-39286-01</b> 11 12 7 561 438</p> 	<p><b>08-38669-01</b> 11 11 7 548 101</p> 		<p><b>61-36120-00</b> 11 12 7 548 797 85,5 Ø 1,2 mm MLS</p> <p><b>61-36120-10</b> 11 12 7 553 210 85,5 Ø 1,5 mm MLS</p> 	<p><b>14-32315-01</b> 11 12 7 548 799</p> 	<p><b>71-39286-00</b> 11 12 7 544 368</p> 	<p><b>12-36866-01</b> 11 34 0 034 068</p>  <p><b>12-37256-01</b> 11 34 0 035 853</p> 	<p><b>11-37133-01</b> </p> <p>11 61 7 547 242</p>    <p><b>71-37134-00</b>  6x</p> <p>18 40 7 530 606</p>  <p><b>71-37136-00</b>   2x</p> <p>18 10 7 549 447</p> 	<p><b>71-38669-00</b> 11 13 7 548 031</p> 	<p><b>81-34057-00</b> </p> <p>11 11 7 547 842 65x79 A SL RD PTFE ACM</p>  <p><b>81-37122-00</b> </p> <p>11 11 7 584 398 90x110 A SL LD PTFE (Polytetrafluorethylen)/ACM (Polyacryl-Kautschuk)</p> <p> 01/09</p>  <p><b>81-40292-00</b> </p> <p>11 11 7 587 168 90x110 A LD FPM</p> <p> 02/09→</p> 	























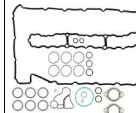

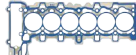

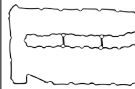
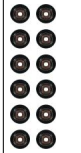
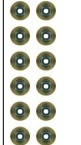

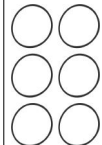







BMW

Ltr.  3,0 N53 B30 A 190-200 kW (258-272 PS)  330i (E92) 528i (F10)  09/07-06/13 

										
	<p><b>02-39286-01</b> 11 12 7 561 438</p> 	<p><b>08-38669-01</b> 11 11 7 548 101</p> 		<p><b>61-36120-00</b> 11 12 7 548 797 85,5 Ø 1,2 mm MLS</p> <p><b>61-36120-10</b> 11 12 7 553 210 85,5 Ø 1,5 mm MLS</p> 	<p><b>14-32315-01</b> 11 12 7 548 799</p> 	<p><b>71-39286-00</b> 11 12 7 544 368</p> 	<p><b>12-36866-01</b> 11 34 0 034 068</p>  <p><b>12-37256-01</b> 11 34 0 035 853</p> 	<p><b>11-37133-01</b>  </p>  <p><b>71-37134-00</b>  6x 18 40 7 530 606</p>  <p><b>71-37136-00</b>   2x 18 10 7 549 447</p> 	<p><b>71-38669-00</b> 11 13 7 548 031</p>  <p><b>71-41291-00</b> 11 13 7 600 482</p> 	<p><b>81-34057-00</b> </p> <p>11 11 7 547 842 65x79 A SL RD PTFE/ACM  02/11</p>  <p><b>81-10378-00</b> </p> <p>11 11 8 618 864 65x79 RD FPM  03/11 →</p>  <p><b>81-37122-00</b> </p> <p>11 11 7 584 398 90x110 A SL LD PTFE (Polytetrafluorethylen)/ACM (Polyacryl-Kautschuk)</p>  <p><b>81-40292-00</b> </p> <p>11 11 7 587 168 90x110 A LD FPM</p> 

BMW



Ltr.  3,0 N53 B30 A 200 kW (272 PS) 330i (E90)  09/07-10/11

















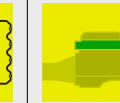
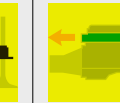
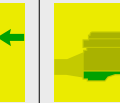
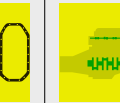

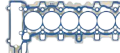

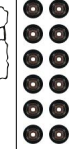
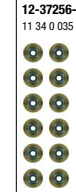











										
	<p><b>02-39286-01</b> 11 12 7 561 438</p> 	<p><b>08-38669-01</b> 11 11 7 548 101</p> 		<p><b>61-36120-00</b> 11 12 7 548 797 85,5 Ø 1,2 mm MLS</p> <p><b>61-36120-10</b> 11 12 7 553 210 85,5 Ø 1,5 mm MLS</p> 	<p><b>14-32315-01</b> 11 12 7 548 799</p> 	<p><b>71-39286-00</b> 11 12 7 544 368</p> 	<p><b>12-36866-01</b> 11 34 0 034 068</p>  <p><b>12-37256-01</b> 11 34 0 035 853</p> 	<p><b>11-37133-01</b>   11 61 7 547 242</p>  <p><b>71-37134-00</b>  6x 18 40 7 530 606</p>  <p><b>71-37136-00</b>   2x 18 10 7 549 447</p> 	<p><b>71-38669-00</b> 11 13 7 548 031</p> 	<p><b>81-34057-00</b>  11 11 7 547 842 65x79 A SL RD PTFE ACM  02/11</p>  <p><b>81-10378-00</b>  11 11 8 618 864 65x79 RD FPM  03/11 →</p>  <p><b>81-37122-00</b>  11 11 7 584 398 90x110 A SL LD PTFE (Polytetrafluorethylen)/ACM (Polyacryl-Kautschuk)  01/09</p>  <p><b>81-40292-00</b>  11 11 7 587 168 90x110 A LD FPM  02/09 →</p> 

BMW











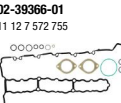

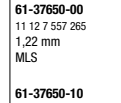
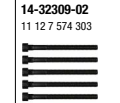
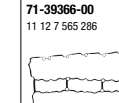
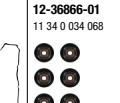
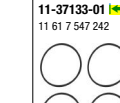
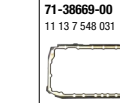
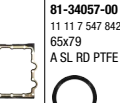
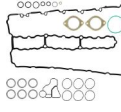

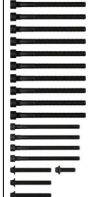
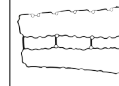
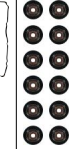
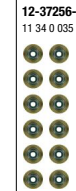





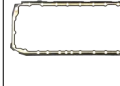

BMW														
Ltr.														
3,0	N53 B30 A	200 kW (272 PS)	330i (E91)	09/07-06/12										
					<p><b>02-39286-01</b> 11 12 7 561 438</p>	<p><b>08-38669-01</b> 11 11 7 548 101</p>		<p><b>61-36120-00</b> 11 12 7 548 797 85,5 Ø 1,2 mm MLS</p> <p><b>61-36120-10</b> 11 12 7 553 210 85,5 Ø 1,5 mm MLS</p>	<p><b>14-32315-01</b> 11 12 7 548 799</p>	<p><b>71-39286-00</b> 11 12 7 544 368</p>	<p><b>12-36866-01</b> 11 34 0 034 068</p> <p><b>12-37256-01</b> 11 34 0 035 853</p>	<p><b>11-37133-01</b> </p> <p><b>71-37134-00</b>  6x 18 40 7 530 606</p> <p><b>71-37136-00</b>   2x 18 10 7 549 447</p>	<p><b>71-38669-00</b> 11 13 7 548 031</p>	<p><b>81-34057-00</b> </p> <p>11 11 7 547 842 65x79 A SL RD PTFE ACM  02/11</p> <p><b>81-10378-00</b> </p> <p>11 11 8 618 864 65x79 RD FPM  03/11 →</p> <p><b>81-34057-00</b> </p> <p>11 11 7 547 842 65x79 A SL RD PTFE ACM</p> <p><b>81-37122-00</b> </p> <p>11 11 7 584 398 90x110 A SL LD PTFE (Polytetrafluorethylen)/ACM (Polyacryl-Kautschuk)</p>
3,0	N53 B30 A	200 kW (272 PS)	530i (F10) 530i (F11)	05/11-06/13										
					<p><b>02-39286-01</b> 11 12 7 561 438</p>			<p><b>61-36120-00</b> 11 12 7 548 797 85,5 Ø 1,2 mm MLS</p> <p><b>61-36120-10</b> 11 12 7 553 210 85,5 Ø 1,5 mm MLS</p>	<p><b>14-32315-01</b> 11 12 7 548 799</p>	<p><b>71-39286-00</b> 11 12 7 544 368</p>	<p><b>12-36866-01</b> 11 34 0 034 068</p> <p><b>12-37256-01</b> 11 34 0 035 853</p>	<p><b>11-37133-01</b> </p> <p><b>71-37134-00</b>  6x 18 40 7 530 606</p> <p><b>71-37136-00</b>   2x 18 10 7 549 447</p>	<p><b>71-41291-00</b> 11 13 7 600 482</p>	<p><b>81-10378-00</b> </p> <p>11 11 8 618 864 65x79 RD FPM</p> <p><b>81-40292-00</b> </p> <p>11 11 7 587 168 90x110 A LD FPM</p>

BMW

Ltr.  3,0 N53 B30 A 200 kW (272 PS) 530 xi (E61) 09/06-09/08 

										
	<p><b>02-39286-01</b> 11 12 7 561 438</p> 	<p><b>08-38669-01</b> 11 11 7 548 101</p> 		<p><b>61-36120-00</b> 11 12 7 548 797 85,5 Ø 1,2 mm MLS</p> <p><b>61-36120-10</b> 11 12 7 553 210 85,5 Ø 1,5 mm MLS</p> 	<p><b>14-32315-01</b> 11 12 7 548 799</p> 	<p><b>71-39286-00</b> 11 12 7 544 368</p> 	<p><b>12-36866-01</b> 11 34 0 034 068</p>  <p><b>12-37256-01</b> 11 34 0 035 853</p> 	<p><b>11-37133-01</b>  </p>    <p><b>71-37134-00</b>  6x 18 40 7 530 606</p>  <p><b>71-37136-00</b>   2x 18 10 7 549 447</p> 	<p><b>71-38669-00</b> 11 13 7 548 031</p>  <p><b>71-41291-00</b> 11 13 7 600 482</p> 	<p><b>81-10378-00 K</b> </p>  <p>11 11 8 618 864 65x79 RD FPM</p> <p><b>81-34057-00 K</b> </p>  <p>11 11 7 547 842 65x79 A SL RD PTFE ACM</p> <p><b>81-37122-00 K</b> </p>  <p>11 11 7 584 398 90x110 A SL LD PTFE (Polytetrafluorethylen)/ACM (Polyacryl-Kautschuk)</p> <p><b>81-40292-00 K</b> </p>  <p>11 11 7 587 168 90x110 A LD FPM</p> 



















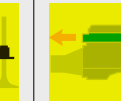



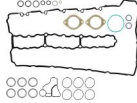

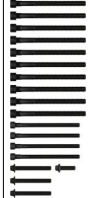
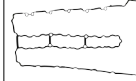



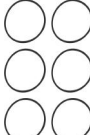















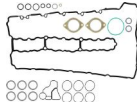
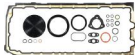
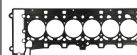
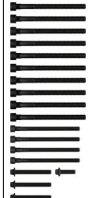
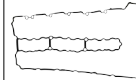





3,0 N54 B30 A 220-225 kW (299-306 PS) 335 i (E90) 03/06-12/11 540 i (E60)

										
	<p><b>02-39366-01</b> 11 12 7 572 755</p> 	<p><b>08-38669-02</b> 11 11 7 567 210</p> 		<p><b>61-37650-00</b> 11 12 7 557 265 1,22 mm MLS</p> <p><b>61-37650-10</b> 11 12 7 557 266 1,52 mm MLS</p> 	<p><b>14-32309-02</b> 11 12 7 574 303</p> 	<p><b>71-39366-00</b> 11 12 7 565 286</p> 	<p><b>12-36866-01</b> 11 34 0 034 068</p>  <p><b>12-37256-01</b> 11 34 0 035 853</p> 	<p><b>11-37133-01</b>  </p>    <p><b>71-39394-00</b>  6x 11 62 7 559 906</p> 	<p><b>71-38669-00</b> 11 13 7 548 031</p> 	<p><b>81-34057-00 K</b> </p>  <p>11 11 7 547 842 65x79 A SL RD PTFE ACM</p> <p><b>81-37122-00 K</b> </p>  <p>11 11 7 584 398 90x110 A SL LD PTFE (Polytetrafluorethylen)/ACM (Polyacryl-Kautschuk)  01/09</p> <p><b>81-40292-00 K</b> </p>  <p>11 11 7 587 168 90x110 A LD FPM  02/09→</p> 

BMW

Ltr.	Icon	Power	Model	Year	Image 1	Image 2	Image 3	Image 4	Image 5	Image 6	Image 7	Image 8	Image 9	Image 10	Image 11	Image 12
3,0	N54 B30 A	224 kW (305 PS)	335 i (E90)	03/06-12/11												
						<p><b>02-39366-01</b> 11 12 7 572 755</p>	<p><b>08-38669-02</b> 11 11 7 567 210</p>	<p><b>04-10318-01</b> </p>	<p><b>61-37650-00</b> 11 12 7 557 265 1,22 mm MLS</p> <p><b>61-37650-10</b> 11 12 7 557 266 1,52 mm MLS</p>	<p><b>14-32309-02</b> 11 12 7 574 303</p>	<p><b>71-39366-00</b> 11 12 7 565 286</p>	<p><b>12-36866-01</b> 11 34 0 034 068</p> <p><b>12-37256-01</b> 11 34 0 035 853</p>	<p><b>11-37133-01</b> </p> <p><b>71-39394-00</b>  6x</p>	<p><b>71-38669-00</b> 11 13 7 548 031</p>	<p><b>81-34057-00</b> </p> <p>11 11 7 547 842 65x79 A SL RD PTFE ACM</p> <p><b>81-40292-00</b> </p> <p>11 11 7 587 168 90x110 A LD FPM</p>	
3,0	N54 B30 A	224 kW (305 PS)	335 i xDrive (E90) 335 xi (E90)	09/06-10/11												
						<p><b>02-39366-01</b> 11 12 7 572 755</p>	<p><b>08-38669-02</b> 11 11 7 567 210</p>		<p><b>61-37650-00</b> 11 12 7 557 265 1,22 mm MLS</p> <p><b>61-37650-10</b> 11 12 7 557 266 1,52 mm MLS</p>	<p><b>14-32309-02</b> 11 12 7 574 303</p>	<p><b>71-39366-00</b> 11 12 7 565 286</p>	<p><b>12-36866-01</b> 11 34 0 034 068</p> <p><b>12-37256-01</b> 11 34 0 035 853</p>	<p><b>11-37133-01</b> </p> <p><b>71-39394-00</b>  6x</p>	<p><b>71-38669-00</b> 11 13 7 548 031</p>	<p><b>81-34057-00</b> </p> <p>11 11 7 547 842 65x79 A SL RD PTFE ACM</p> <p><b>81-37122-00</b> </p> <p>11 11 7 584 398 90x110 A SL LD PTFE (Polytetrafluorethylen)/ACM (Polyacryl-Kautschuk)</p>	

BMW

BMW																
3,0	N54 B30 A	224-240 kW (305-326 PS)	X6 xDrive 35 i (E71, E72) X6 3.5 i (E71) 135 i (E82) 335 i (E91) 335 i (E92) 335 i xDrive (E91) 335 i xDrive (E92) 335 xi (E92) 740 i (F01, F02)	06/06-07/14			<b>02-39366-01</b> 11 12 7 572 755 	<b>08-38669-02</b> 11 11 7 567 210 		<b>61-37650-00</b> 11 12 7 557 265 1,22 mm MLS  <b>61-37650-10</b> 11 12 7 557 266 1,52 mm MLS 	<b>14-32309-02</b> 11 12 7 574 303 	<b>71-39366-00</b> 11 12 7 565 286 	<b>12-36866-01</b> 11 34 0 034 068   <b>12-37256-01</b> 11 34 0 035 853 	<b>11-37133-01</b>  11 61 7 547 242   <b>71-39394-00</b>  6x 11 62 7 558 906   <b>71-11399-00</b>   18 30 7 553 601 	<b>71-38669-00</b> 11 13 7 548 031 	<b>81-34057-00</b>  11 11 7 547 842 65x79 A SL RD PTFE ACM   <b>81-37122-00</b>  11 11 7 584 398 90x110 A SL LD PTFE (Polytetrafluorethylen)/ACM (Polyacryl-Kautschuk)   01/09   <b>81-40292-00</b>  11 11 7 587 168 90x110 A LD FPM  02/09 → 
3,0	N54 B30 A	224-240 kW (305-326 PS)	X6 3.5 i (E72) Z4 sDrive 35 i (E89)	06/07-08/16		<b>02-39366-01</b> 11 12 7 572 755 	<b>08-38669-02</b> 11 11 7 567 210 		<b>61-37650-00</b> 11 12 7 557 265 1,22 mm MLS  <b>61-37650-10</b> 11 12 7 557 266 1,52 mm MLS 	<b>14-32309-02</b> 11 12 7 574 303 	<b>71-39366-00</b> 11 12 7 565 286 	<b>12-36866-01</b> 11 34 0 034 068   <b>12-37256-01</b> 11 34 0 035 853 	<b>11-37133-01</b>  11 61 7 547 242   <b>71-39394-00</b>  6x 11 62 7 558 906   <b>71-11399-00</b>   18 30 7 553 601 	<b>71-38669-00</b> 11 13 7 548 031 	<b>81-34057-00</b>  11 11 7 547 842 65x79 A SL RD PTFE ACM   <b>81-40292-00</b>  11 11 7 587 168 90x110 A LD FPM  02/09 → 	

BMW

Ltr.														
3,0	N54 B30 A N54 B30 B	224-240 kW (305-326 PS)	135 i (E82) 135 i (E88) 335 i (E90) 335 i (E91) 335 i (E92) 335 i (E93) 535 xi (E61)	03/06										
					<b>02-39366-01</b> 11 12 7 572 755 	<b>08-38669-02</b> 11 11 7 567 210 	<b>04-10318-01</b> 	<b>61-37650-00</b> 11 12 7 557 265 1,22 mm MLS  <b>61-37650-10</b> 11 12 7 557 266 1,52 mm MLS 	<b>14-32309-02</b> 11 12 7 574 303 	<b>71-39366-00</b> 11 12 7 565 286 	<b>12-36866-01</b> 11 34 0 034 068 	<b>11-37133-01</b> 11 61 7 547 242 	<b>71-38669-00</b> 11 13 7 548 031 	<b>81-34057-00</b> 11 11 7 547 842 65x79 A SL RD PTFE ACM   <b>81-37122-00</b> 11 11 7 584 398 90x110 A SL LD PTFE (Polytetrafluorethylen)/ACM (Polyacryl-Kautschuk)  <b>81-40292-00</b> 11 11 7 587 168 90x110 A LD FPM  <b>81-34057-00</b> 11 11 7 547 842 65x79 A SL RD PTFE ACM   <b>81-37122-00</b> 11 11 7 584 398 90x110 A SL LD PTFE (Polytetrafluorethylen)/ACM (Polyacryl-Kautschuk) 
3,0	N54 B30 A	225 kW (306 PS)	335 xi (E90) 335 xi (E91)	03/07-08/08										
					<b>02-39366-01</b> 11 12 7 572 755 	<b>08-38669-02</b> 11 11 7 567 210 	<b>04-10318-01</b> 	<b>61-37650-00</b> 11 12 7 557 265 1,22 mm MLS  <b>61-37650-10</b> 11 12 7 557 266 1,52 mm MLS 	<b>14-32309-02</b> 11 12 7 574 303 	<b>71-39366-00</b> 11 12 7 565 286 	<b>12-36866-01</b> 11 34 0 034 068 	<b>11-37133-01</b> 11 61 7 547 242 	<b>71-38669-00</b> 11 13 7 548 031 	<b>81-34057-00</b> 11 11 7 547 842 65x79 A SL RD PTFE ACM   <b>81-37122-00</b> 11 11 7 584 398 90x110 A SL LD PTFE (Polytetrafluorethylen)/ACM (Polyacryl-Kautschuk) 

BMW

Ltr.	Icon	Power	Model	Year	Image 1	Image 2	Image 3	Image 4	Image 5	Image 6	Image 7	Image 8	Image 9	Image 10	Image 11	Image 12
3,0	N54 B30 A	225 kW (306 PS)	335 xi (E92)	03/07-02/10												
						<p><b>02-39366-01</b> 11 12 7 572 755</p>	<p><b>08-38669-02</b> 11 11 7 567 210</p>	<p><b>04-10318-01</b> </p>	<p><b>61-37650-00</b> 11 12 7 557 265 1,22 mm MLS</p> <p><b>61-37650-10</b> 11 12 7 557 266 1,52 mm MLS</p>	<p><b>14-32309-02</b> 11 12 7 574 303</p>	<p><b>71-39366-00</b> 11 12 7 565 286</p>	<p><b>12-36866-01</b> 11 34 0 034 068</p>	<p><b>11-37133-01</b> </p>	<p><b>71-38669-00</b> 11 13 7 548 031</p>	<p><b>81-34057-00</b> </p> <p>11 11 7 547 842 65x79 A SL RD PTFE ACM</p> <p><b>81-37122-00</b> </p> <p>11 11 7 584 398 90x110 A SL LD PTFE (Polytetrafluorethylen)/ACM (Polyacryl-Kautschuk)  01/09</p>	
3,0	N54 B30 A	225-250 kW (306-340 PS)	M 130 i (E82) Z4 3.5 i (E89) Z4 3.5 is (E89)	02/09-08/16												
						<p><b>02-39366-01</b> 11 12 7 572 755</p>	<p><b>08-38669-02</b> 11 11 7 567 210</p>	<p><b>04-10318-01</b> </p>	<p><b>61-37650-00</b> 11 12 7 557 265 1,22 mm MLS</p> <p><b>61-37650-10</b> 11 12 7 557 266 1,52 mm MLS</p>	<p><b>14-32309-02</b> 11 12 7 574 303</p>	<p><b>71-39366-00</b> 11 12 7 565 286</p>	<p><b>12-36866-01</b> 11 34 0 034 068</p>	<p><b>11-37133-01</b> </p>	<p><b>71-38669-00</b> 11 13 7 548 031</p>	<p><b>81-34057-00</b> </p> <p>11 11 7 547 842 65x79 A SL RD PTFE ACM</p> <p><b>81-40292-00</b> </p> <p>11 11 7 587 168 90x110 A LD FPM</p>	
3,0	N54 B30 A	240 kW (326 PS)	335 i (E93)	05/06-10/13												
							<p><b>08-38669-02</b> 11 11 7 567 210</p>									<p><b>71-39366-00</b> 11 12 7 565 286</p>



BMW															
Ltr.															
3,0	N54 B30 A	240 kW (326 PS)	335 i xDrive (E90)	05/08-10/11		<b>02-39366-01</b> 11 12 7 572 755  MLS	<b>08-38669-02</b> 11 11 7 567 210  MLS		<b>61-37650-00</b> 11 12 7 557 265 1,22 mm MLS  <b>61-37650-10</b> 11 12 7 557 266 1,52 mm MLS 	<b>14-32309-02</b> 11 12 7 574 303 	<b>71-39366-00</b> 11 12 7 565 286 	<b>12-36866-01</b> 11 34 0 034 068   <b>12-37256-01</b> 11 34 0 035 853 	<b>11-37133-01</b> 11 61 7 547 242   <b>71-39394-00</b> 6x 11 62 7 558 906   <b>71-11399-00</b> 18 30 7 553 601 	<b>71-38669-00</b> 11 13 7 548 031 	<b>81-34057-00 K</b> 11 11 7 547 842 65x79 A SL RD PTFE ACM   <b>81-37122-00 K</b> 11 11 7 584 398 90x110 A SL LD PTFE (Polytetrafluorethylen)/ACM (Polyacryl-Kautschuk)  01/09
3,0	N54 B30 A	240 kW (326 PS)	335 xi (E91) 520 d (E90)	09/06-08/08	<b>02-39366-01</b> 11 12 7 572 755  MLS	<b>08-38669-02</b> 11 11 7 567 210  MLS		<b>61-37650-00</b> 11 12 7 557 265 1,22 mm MLS  <b>61-37650-10</b> 11 12 7 557 266 1,52 mm MLS 	<b>14-32309-02</b> 11 12 7 574 303 	<b>71-39366-00</b> 11 12 7 565 286 	<b>12-36866-01</b> 11 34 0 034 068   <b>12-37256-01</b> 11 34 0 035 853 	<b>11-37133-01</b> 11 61 7 547 242   <b>71-39394-00</b> 6x 11 62 7 558 906   <b>71-11399-00</b> 18 30 7 553 601 	<b>71-38669-00</b> 11 13 7 548 031 	<b>81-34057-00 K</b> 11 11 7 547 842 65x79 A SL RD PTFE ACM   <b>81-37122-00 K</b> 11 11 7 584 398 90x110 A SL LD PTFE (Polytetrafluorethylen)/ACM (Polyacryl-Kautschuk)  	
3,0	N55 B30 A	220 kW (299 PS)	335 i (E90)	03/06-12/11	<b>02-10002-03</b> 		<b>04-10362-01</b> 	<b>61-38060-00</b> 11 12 7 599 212 85 Ø 1,2 mm MLS  <b>61-38060-10</b> 11 12 7 599 213 85 Ø 1,5 mm MLS 	<b>14-10427-01</b> 11 12 2 165 470 	<b>15-10002-01</b> 11 12 7 587 804 	<b>12-36866-01</b> 11 34 0 034 068   <b>12-37256-01</b> 11 34 0 035 853 	<b>11-37133-01</b> 11 61 7 547 242   <b>71-41318-00</b> 11 61 7 588 624   <b>71-10129-00</b> 6x 11 65 7 593 303 	<b>71-41291-00</b> 11 13 7 600 482 	<b>81-34057-00 K</b> 11 11 7 547 842 65x79 A SL RD PTFE ACM  02/11  <b>81-10378-00 K</b> 11 11 8 618 864 65x79 RD FPM  03/11→  <b>81-40292-00 K</b> 11 11 7 587 168 90x110 A LD FPM 	

BMW

Ltr.													
3,0	N55 B30 A	224-240 kW (305-326 PS)	03/06-08/17	X3 3.5 i (F25) X6 xDrive 35 i (E71, E72) 135 i (E82) 135 i (E88) 335 i (E90) 335 i (E91) 335 i (E92) 335 i (E93) 335 i xDrive (E90) 335 i xDrive (E91) 335 i xDrive (E92) 535 i (F07) 535 i (F07) 535 i (F10) 535 i (F11) 535 i xDrive (F07)	02-10002-03	04-10362-01	61-38060-00 11 12 7 599 212 85 Ø 1,2 mm MLS  61-38060-10 11 12 7 599 213 85 Ø 1,5 mm MLS	14-10427-01 11 12 2 165 470	15-10002-01 11 12 7 587 804	12-36866-01 11 34 0 034 068  12-37256-01 11 34 0 035 853	11-37133-01 11 61 7 547 242  71-41318-00 11 61 7 588 624  71-10129-00  6x 11 65 7 593 303  71-11399-00 18 30 7 553 601	71-41291-00 11 13 7 600 482	81-34057-00 11 11 7 547 842 65x79 A SL RD PTFE ACM 02/11  81-10378-00 11 11 8 618 864 65x79 RD FPM 03/11 →  81-40292-00 11 11 7 587 168 90x110 A LD FPM
3,0	N55 B30 A	224-272 kW (305-370 PS)	09/06	M 135 i (F20) M 135 i (F21) M 135 i xDrive (F20) M 135 i xDrive (F21) M 235 i M 235 i (F23) M 235 i xDrive (F22, F87) M 235 i xDrive (F23) M2 (F22, F87) X4 M 40 i (F26) X4 xDrive 35 i (F26) X5 sDrive 35 i (F15, F85) X5 xDrive 35 i (F15, F85) X5 xDrive 40 i (E70) X5 3.5 i (E70) X5 3.5 i (F15) X6 sDrive 35 i (F16, F86) X6 xDrive 35 i (F16, F86) X6 3.5 i (E71, E72) 3 (F30) Hybrid 3 335 i (E90) 335 i (F30) 335 i (F30, F80) 335 i (F31) 335 i (F34) 335 i xDrive (F30, F35, F80) 335 i xDrive (F30, F80) 335 i xDrive (F31) 335 i xDrive (F34) 435 i (F32) 435 i (F33, F83) 435 i (F36) 435 i xDrive (F32, F82) 435 i xDrive (F33, F83) 435 i xDrive (F36) 435 i 435 i 5 (F10) Hybrid 5 535 i (F10) 535 i (F11) 535 i xDrive (F10) 535 i xDrive (F11) 640 i (F06) 640 i (F12) 640 i (F13) 640 i xDrive (F06) 7 (F01, F02) Hybrid 7 740 i, Li (F01, F02, F03, F04) 740 i, Li xDrive (F01, F02, F03, F04)	02-10002-03	04-10362-01	61-38060-00 11 12 7 599 212 85 Ø 1,2 mm MLS  61-38060-10 11 12 7 599 213 85 Ø 1,5 mm MLS	14-10427-01 11 12 2 165 470	15-10002-01 11 12 7 587 804	12-36866-01 11 34 0 034 068  12-37256-01 11 34 0 035 853	11-37133-01 11 61 7 547 242  71-41318-00 11 61 7 588 624  71-10129-00  6x 11 65 7 593 303  71-11399-00 18 30 7 553 601	71-41291-00 11 13 7 600 482	81-10378-00 11 11 8 618 864 65x79 RD FPM  81-40292-00 11 11 7 587 168 90x110 A LD FPM

BMW														
Ltr.														
3,0	N55 B30 A	225 kW (306 PS)	04/10-07/13		02-10002-03 		04-10362-01 	61-38060-00 11 12 7 599 212 85 Ø 1,2 mm MLS  61-38060-10 11 12 7 599 213 85 Ø 1,5 mm MLS 	14-10427-01 11 12 2 165 470 	15-10002-01 11 12 7 587 804 	12-36866-01 11 34 0 034 068   12-37256-01 11 34 0 035 853 	11-37133-01 11 61 7 547 242   71-41318-00 11 61 7 588 624   71-10129-00  6x 11 65 7 593 303  71-11399-00 18 30 7 553 601 	71-41291-00 11 13 7 600 482 	81-10378-00 11 11 8 618 864 65x79 RD FPM  04/11→  81-40292-00 11 11 7 587 168 90x110 ALD FPM 
3,0	N55 B30 A	225 kW (306 PS)	01/08-07/14		02-10002-03 		04-10362-01 	61-38060-00 11 12 7 599 212 85 Ø 1,2 mm MLS  61-38060-10 11 12 7 599 213 85 Ø 1,5 mm MLS 	14-10427-01 11 12 2 165 470 	15-10002-01 11 12 7 587 804 	12-36866-01 11 34 0 034 068   12-37256-01 11 34 0 035 853 	11-37133-01 11 61 7 547 242   71-41318-00 11 61 7 588 624   71-10129-00  6x 11 65 7 593 303  71-11399-00 18 30 7 553 601 	71-41291-00 11 13 7 600 482 	81-40292-00 11 11 7 587 168 90x110 ALD FPM 





































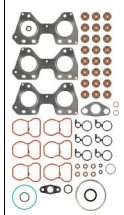



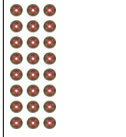









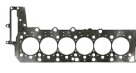







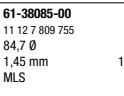
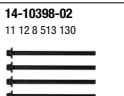
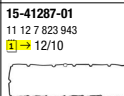

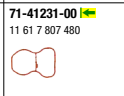

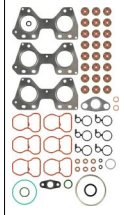
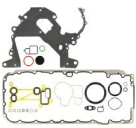

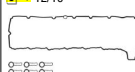
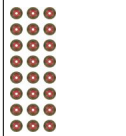

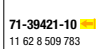















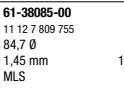
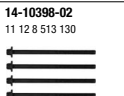
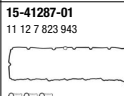

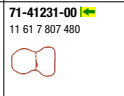

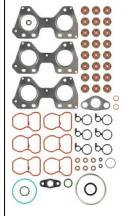
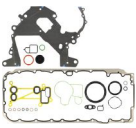



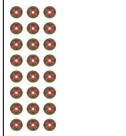



BMW

Ltr.	Motor	Power (kW/PS)	Model	Year	Image 1	Image 2	Image 3	Image 4	Image 5	Image 6	Image 7	Image 8	Image 9	Image 10	Image 11	Image 12
3,0	N55 B30 A	225 kW (306 PS)	335 xi (E91) 335 xi (E92)	03/07-02/10												
						02-10002-03		04-10362-01	61-38060-00 11 12 7 599 212 85 Ø 1,2 mm MLS  61-38060-10 11 12 7 599 213 85 Ø 1,5 mm MLS 	14-10427-01 11 12 2 165 470 	15-10002-01 11 12 7 587 804 	12-36866-01 11 34 0 034 068   12-37256-01 11 34 0 035 853 	11-37133-01 11 61 7 547 242   71-41318-00 11 61 7 588 624   71-10129-00 11 65 7 593 303 6x   71-11399-00 18 30 7 553 601 	71-41291-00 11 13 7 600 482 	81-34057-00 11 11 7 547 842 65x79 A SL RD PTFE ACM   81-40292-00 11 11 7 587 168 90x110 A LD FPM 	
3,0	N55 B30 A	235 kW (320 PS)	M 235 i (F22, F87)	03/14-06/16		02-10002-03		04-10362-01	61-38060-00 11 12 7 599 212 85 Ø 1,2 mm MLS  61-38060-10 11 12 7 599 213 85 Ø 1,5 mm MLS 	14-10427-01 11 12 2 165 470 	15-10002-01 11 12 7 587 804 	12-36866-01 11 34 0 034 068   12-37256-01 11 34 0 035 853 	11-37133-01 11 61 7 547 242   71-41318-00 11 61 7 588 624   71-10129-00 11 65 7 593 303 6x   71-11399-00 18 30 7 553 601 	71-41291-00 11 13 7 600 482 	81-10378-00 11 11 8 618 864 65x79 RD FPM   81-40292-00 11 11 7 587 168 90x110 A LD FPM 	
3,0	N55 B30 A	240 kW (326 PS)	335 i xDrive (F34)	03/13-03/14		02-10002-03		04-10362-01	61-38060-00 11 12 7 599 212 85 Ø 1,2 mm MLS  61-38060-10 11 12 7 599 213 85 Ø 1,5 mm MLS 	14-10427-01 11 12 2 165 470 	15-10002-01 11 12 7 587 804 	12-36866-01 11 34 0 034 068   12-37256-01 11 34 0 035 853 	11-37133-01 11 61 7 547 242   71-41318-00 11 61 7 588 624   71-10129-00 11 65 7 593 303 6x   71-11399-00 18 30 7 553 601 	71-41291-00 11 13 7 600 482 	81-10378-00 11 11 8 618 864 65x79 RD FPM   81-40292-00 11 11 7 587 168 90x110 A LD FPM 	



BMW

Ltr.																			
3,0	N57 D30 A	150-180 kW (204-245 PS)	X5 3.0 d (E70) X6 3.0 d (E71, E72) X6 3.0 d (E71, E72) 325 d (E90) 325 d (E91) 325 d (E92) 325 d (E93) 330 d (E90) 330 d (E91) 330 d (E92) 330 d (E93) 330 xd (E91) 525 d (F10) 525 d (F11) 530 d (F07) 530 d (F10) 530 d (F11) 730 d (F01, F02)	09/05-02/17		<b>02-41296-01</b> 11 12 8 508 558	<b>08-41294-01</b> 11 11 8 508 077		<b>61-38085-00</b> 11 12 7 809 755 84,7 Ø 1,45 mm MLS	<b>14-10398-02</b> 11 12 8 513 130	<b>15-41287-01</b> 11 12 7 823 943 12/10	<b>12-41303-01</b> 11 34 7 812 926	<b>71-41231-00</b> 11 61 7 807 480	6x	<b>71-41294-00</b> 11 13 7 809 836	<b>81-39382-00</b> 11 11 7 802 665 55x68 RD FPM		<b>81-39379-00</b> 11 14 7 797 490 90x104 LD FPM	
3,0	N57 D30 A	155 kW (211 PS)	330 d (E91)	06/05-05/12		<b>02-41296-01</b> 11 12 8 508 558													
3,0	N57 D30 A	155 kW (211 PS)	730 d xDrive (F01, F02, F03, F04)	11/11-05/15		<b>02-41296-01</b> 11 12 8 508 558	<b>08-41294-01</b> 11 11 8 508 077		<b>61-38120-00</b> 11 12 8 509 152 85 Ø 1,45 mm MLS	<b>14-10398-02</b> 11 12 8 513 130	<b>15-41288-01</b> 11 12 8 515 732	<b>12-41303-01</b> 11 34 7 812 926	<b>71-10390-00</b> 11 61 8 507 335	6x	<b>71-41294-00</b> 11 13 7 809 836	<b>81-39382-00</b> 11 11 7 802 665 55x68 RD FPM		<b>81-39379-00</b> 11 14 7 797 490 90x104 LD FPM	

BMW

Ltr.														
3,0	N57 D30 A	155-210 kW (211-286 PS)												
					<b>02-41296-01</b> 11 12 8 508 558 			<b>61-38120-00</b> 11 12 8 509 152 85 Ø 1,45 mm MLS 	<b>14-10398-02</b> 11 12 8 513 130 	<b>15-41288-01</b> 11 12 8 515 732 	<b>12-41303-01</b> 11 34 7 812 926 	<b>71-10390-00</b>  11 62 8 509 335 	<b>70-31414-10</b> 	<b>81-39382-00</b>  11 11 7 802 665 55x68 RD FPM 
								<b>61-38120-10</b> 11 12 8 509 153 85 Ø 1,55 mm MLS 				<b>71-39421-10</b>  11 62 8 509 783 3x 		<b>81-39379-00</b>  11 14 7 797 490 90x104 LD FPM 
								<b>61-38120-20</b> 11 12 8 509 154 85 Ø 1,65 mm MLS 				<b>71-41329-00</b>  11 65 7 808 159 		
3,0	N57 D30 A	180 kW (245 PS)		02/10-06/13										
					<b>02-41296-01</b> 11 12 8 508 558 	<b>08-41294-01</b> 11 11 8 508 077 		<b>61-38085-00</b> 11 12 7 809 755 84,7 Ø 1,45 mm MLS 	<b>14-10398-02</b> 11 12 8 513 130 	<b>15-41287-01</b> 11 12 7 823 943 	<b>12-41303-01</b> 11 34 7 812 926 	<b>71-41231-00</b>  11 61 7 807 480 	<b>71-41294-00</b> 11 13 7 809 836 	<b>81-39382-00</b>  11 11 7 802 665 55x68 RD FPM 
								<b>61-38085-10</b> 11 12 7 809 756 84,7 Ø 1,55 mm MLS 				<b>71-39421-10</b>  11 62 8 509 783 3x 		<b>81-39379-00</b>  11 14 7 797 490 90x104 LD FPM 
								<b>61-38085-20</b> 11 12 7 809 757 84,7 Ø 1,65 mm MLS 				<b>71-41329-00</b>  11 65 7 808 159 		
3,0	N57 D30 A	180 kW (245 PS)		03/08-02/10										
					<b>02-41296-01</b> 11 12 8 508 558 	<b>08-41294-01</b> 11 11 8 508 077 		<b>61-38085-00</b> 11 12 7 809 755 84,7 Ø 1,45 mm MLS 	<b>14-10398-02</b> 11 12 8 513 130 	<b>15-41287-01</b> 11 12 7 823 943 	<b>12-41303-01</b> 11 34 7 812 926 	<b>71-41231-00</b>  11 61 7 807 480 	<b>71-41294-00</b> 11 13 7 809 836 	<b>81-39382-00</b>  11 11 7 802 665 55x68 RD FPM 
								<b>61-38085-10</b> 11 12 7 809 756 84,7 Ø 1,55 mm MLS 				<b>71-39421-10</b>  11 62 8 509 783 3x 		<b>81-39379-00</b>  11 14 7 797 490 90x104 LD FPM 
								<b>61-38085-20</b> 11 12 7 809 757 84,7 Ø 1,65 mm MLS 				<b>71-41329-00</b>  11 65 7 808 159 		

BMW

Ltr.  N57 D30 A 180 kW (245 PS) 730 d (F01, F02) 09/08-06/12 

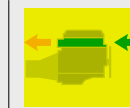

3,0 N57 D30 A 180 kW (245 PS) 730 d (F01, F02) 09/08-06/12

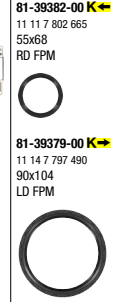
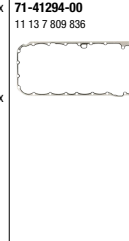
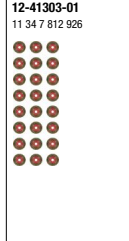
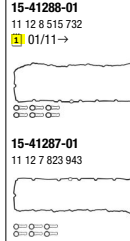
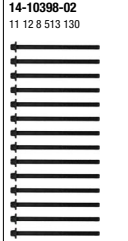
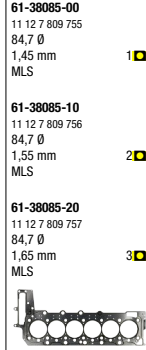
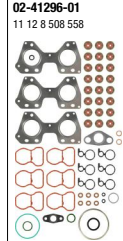



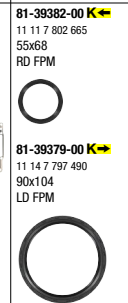
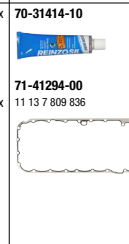
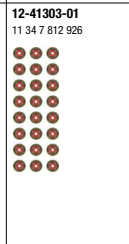
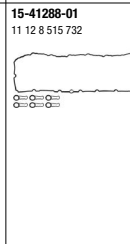
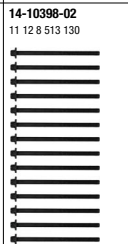
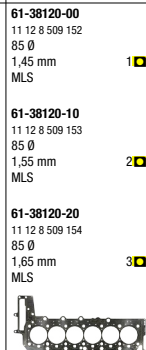
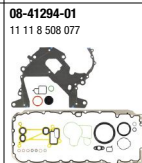
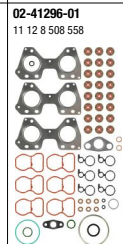



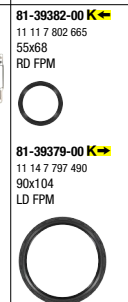
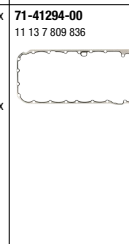
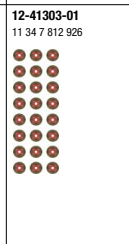
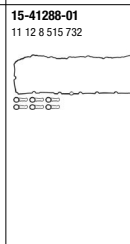
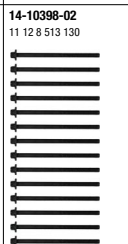
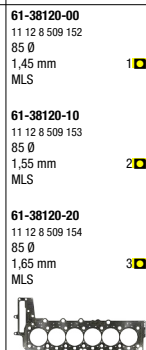
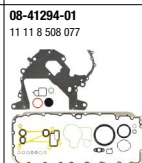
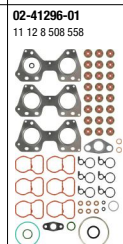





















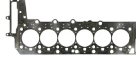
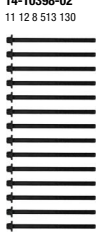
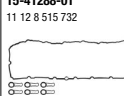
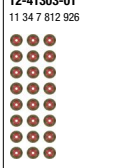

















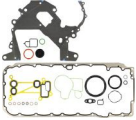





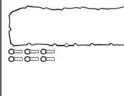
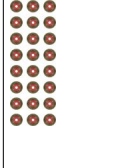



3,0 N57 D30 A 190 kW (258 PS) 330 d (F31) 03/13-06/19



3,0 N57 D30 A 190 kW (258 PS) 530 d (F07) 07/12-02/17



BMW



















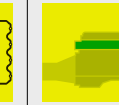
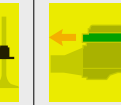
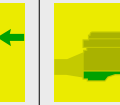

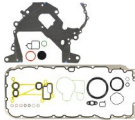
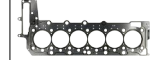
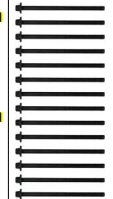

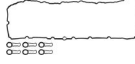
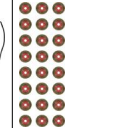







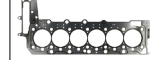
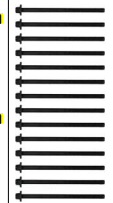

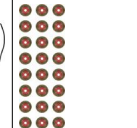







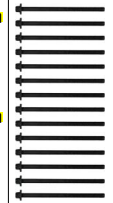
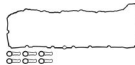
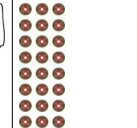

<p>Ltr.  N57 D30 A 190 kW (258 PS) 530 d (F10) 09/11-10/16 </p>											
<p>3,0 N57 D30 A 190 kW (258 PS) 530 d (F10) 03/11-02/17 530 d (F11)</p>					<p>61-38120-00 11 12 8 509 152 85 Ø 1,45 mm MLS </p> <p>61-38120-10 11 12 8 509 153 85 Ø 1,55 mm MLS </p> <p>61-38120-20 11 12 8 509 154 85 Ø 1,65 mm MLS </p> 	<p>14-10398-02 11 12 8 513 130</p> 	<p>15-41288-01 11 12 8 515 732</p> 	<p>12-41303-01 11 34 7 812 926</p> 	<p>71-10390-00  6x 11 61 8 507 335</p>  <p>71-39421-10  3x 11 62 8 509 783</p>  <p>71-41329-00  16 11 65 7 808 159</p> 	<p>70-31414-10  11 13 7 809 836</p>  <p>71-41294-00 11 13 7 809 836</p> 	<p>81-39382-00   11 11 7 802 665 55x68 RD FPM</p>  <p>81-39379-00   11 14 7 797 490 90x104 LD FPM</p> 
<p>3,0 N57 D30 A 190 kW (258 PS) 730 d (F01, F02, F03, F04) 11/11-05/15</p>			<p>08-41294-01 11 11 8 508 077</p> 		<p>61-38085-00 11 12 7 809 755 84,7 Ø 1,45 mm MLS </p> <p>61-38085-10 11 12 7 809 756 84,7 Ø 1,55 mm MLS </p> <p>61-38085-20 11 12 7 809 757 84,7 Ø 1,65 mm MLS </p> 	<p>14-10398-02 11 12 8 513 130</p> 	<p>15-41288-01 11 12 8 515 732</p> 	<p>12-41303-01 11 34 7 812 926</p> 	<p>71-41231-00  6x 11 61 7 807 480</p>  <p>71-39421-10  3x 11 62 8 509 783</p>  <p>71-41329-00  16 11 65 7 808 159</p> 	<p>71-41294-00 11 13 7 809 836</p> 	<p>81-39382-00   11 11 7 802 665 55x68 RD FPM</p>  <p>81-39379-00   11 14 7 797 490 90x104 LD FPM</p> 























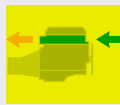



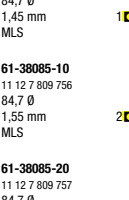

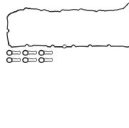
BMW

BMW														
Ltr.														
3,0	N57 D30 A	210 kW (286 PS)	X3 xDrive 30 d (F25)	04/11-05/16										
					<p><b>02-41296-01</b> 11 12 8 508 558</p>	<p><b>08-41294-01</b> 11 11 8 508 077</p>		<p><b>61-38120-00</b> 11 12 8 509 152 85 Ø 1,45 mm MLS</p> <p><b>61-38120-10</b> 11 12 8 509 153 85 Ø 1,55 mm MLS</p> <p><b>61-38120-20</b> 11 12 8 509 154 85 Ø 1,65 mm MLS</p>	<p><b>14-10398-02</b> 11 12 8 513 130</p>	<p><b>15-41288-01</b> 11 12 8 515 732</p>	<p><b>12-41303-01</b> 11 34 7 812 926</p>	<p><b>71-10390-00</b>  11 61 8 507 335</p> <p><b>71-39421-10</b>  11 62 8 509 783</p> <p><b>71-41329-00</b>  11 65 7 808 159</p>	<p><b>70-31414-10</b> </p>	<p><b>81-39382-00</b>  11 11 7 802 665 55x68 RD FPM</p> <p><b>81-39379-00</b>  11 14 7 797 490 90x104 LD FPM</p>
3,0	N57 D30 A	210 kW (286 PS)	530 d xDrive (F10)	03/11-10/16	<p><b>02-41296-01</b> 11 12 8 508 558</p>	<p><b>08-41294-01</b> 11 11 8 508 077</p>		<p><b>61-38085-00</b> 11 12 7 809 755 84,7 Ø 1,45 mm MLS</p> <p><b>61-38085-10</b> 11 12 7 809 756 84,7 Ø 1,55 mm MLS</p> <p><b>61-38085-20</b> 11 12 7 809 757 84,7 Ø 1,65 mm MLS</p>	<p><b>14-10398-02</b> 11 12 8 513 130</p>	<p><b>15-41288-01</b> 11 12 8 515 732</p>	<p><b>12-41303-01</b> 11 34 7 812 926</p>	<p><b>71-41231-10</b>  11 61 7 807 480</p> <p><b>71-39421-10</b>  11 62 8 509 783</p> <p><b>71-41329-00</b>  11 65 7 808 159</p>	<p><b>71-41294-00</b> 11 13 7 809 836</p>	<p><b>81-39382-00</b>  11 11 7 802 665 55x68 RD FPM</p> <p><b>81-39379-00</b>  11 14 7 797 490 90x104 LD FPM</p>
3,0	N57 D30 A	210 kW (286 PS)	530 d xDrive (F11)	03/11-02/17	<p><b>02-41296-01</b> 11 12 8 508 558</p>	<p><b>08-41294-01</b> 11 11 8 508 077</p>		<p><b>61-38120-00</b> 11 12 8 509 152 85 Ø 1,45 mm MLS</p> <p><b>61-38120-10</b> 11 12 8 509 153 85 Ø 1,55 mm MLS</p> <p><b>61-38120-20</b> 11 12 8 509 154 85 Ø 1,65 mm MLS</p>	<p><b>14-10398-02</b> 11 12 8 513 130</p>	<p><b>15-41288-01</b> 11 12 8 515 732</p>	<p><b>12-41303-01</b> 11 34 7 812 926</p>	<p><b>71-10390-00</b>  11 61 8 507 335</p> <p><b>71-39421-10</b>  11 62 8 509 783</p> <p><b>71-41329-00</b>  11 65 7 808 159</p>	<p><b>71-41294-00</b> 11 13 7 809 836</p>	<p><b>81-39382-00</b>  11 11 7 802 665 55x68 RD FPM</p> <p><b>81-39379-00</b>  11 14 7 797 490 90x104 LD FPM</p>

BMW

<p>Ltr.  N57 D30 B</p> <p>220-225 kW (299-306 PS)</p> <p>X6 (E71, E72) 535 d (F07) 535 d (F10) 535 d (F11) 740 d (F01, F02) 740 d (F01, F02)</p> <p>07/09-06/14</p>           	<p><b>08-41294-01</b> 11 11 8 508 077</p> 	<p><b>61-38085-00</b> 11 12 7 809 755 84,7 Ø 1,45 mm MLS</p> <p><b>61-38085-10</b> 11 12 7 809 756 84,7 Ø 1,55 mm MLS</p> <p><b>61-38085-20</b> 11 12 7 809 757 84,7 Ø 1,65 mm MLS</p> 	<p><b>14-10398-02</b> 11 12 8 513 130</p> 	<p><b>15-41287-01</b> 11 12 7 823 943 12/10</p>  <p><b>15-41288-01</b> 11 12 8 515 732 01/11</p> 	<p><b>12-41303-01</b> 11 34 7 812 926</p> 	<p><b>71-41231-00</b>  6x 11 61 7 807 480</p>  <p><b>71-39421-10</b> 3x 11 62 8 509 783</p> 	<p><b>71-41294-00</b> 11 13 7 809 836</p> 	<p><b>81-39382-00</b>  11 11 7 802 665 55x68 RD FPM</p>  <p><b>81-39379-00</b>  11 14 7 797 490 90x104 LD FPM</p> 
<p>3,0 N57 D30 B</p> <p>225 kW (306 PS)</p> <p>X5 4.0 d (E70)</p> <p>09/10-06/13</p>		<p><b>61-38085-00</b> 11 12 7 809 755 84,7 Ø 1,45 mm MLS</p> <p><b>61-38085-10</b> 11 12 7 809 756 84,7 Ø 1,55 mm MLS</p> <p><b>61-38085-20</b> 11 12 7 809 757 84,7 Ø 1,65 mm MLS</p> 	<p><b>14-10398-02</b> 11 12 8 513 130</p> 	<p><b>15-41287-01</b> 11 12 7 823 943 11/10</p>  <p><b>15-41288-01</b> 11 12 8 515 732 12/10</p> 	<p><b>12-41303-01</b> 11 34 7 812 926</p> 	<p><b>71-41231-00</b>  6x 11 61 7 807 480</p>  <p><b>71-39421-10</b> 3x 11 62 8 509 783</p> 	<p><b>71-41294-00</b> 11 13 7 809 836</p> 	<p><b>81-39382-00</b>  11 11 7 802 665 55x68 RD FPM</p>  <p><b>81-39379-00</b>  11 14 7 797 490 90x104 LD FPM</p> 
<p>3,0 N57 D30 B</p> <p>230 kW (313 PS)</p> <p>X3 (F25) X4 xDrive 35 d (F26) X5 xDrive 40 d (F15) X6 xDrive 40 d (F16, F86) 335 d (F30) 335 d xDrive (F34) 335 d xDrive(F31) 435 d (F32) 435 d xDrive (F33, F83) 435 d xDrive (F36) 640 d (F06) 640 d (F12) 640 d (F13) 640 d xDrive (F12) 740 d (F01)</p> <p>09/11</p>		<p><b>61-38120-00</b> 11 12 8 509 152 85 Ø 1,45 mm MLS</p> <p><b>61-38120-10</b> 11 12 8 509 153 85 Ø 1,55 mm MLS</p> <p><b>61-38120-20</b> 11 12 8 509 154 85 Ø 1,65 mm MLS</p> 	<p><b>14-10398-02</b> 11 12 8 513 130</p> 	<p><b>15-41288-01</b> 11 12 8 515 732</p> 	<p><b>12-41303-01</b> 11 34 7 812 926</p> 	<p><b>71-10390-00</b>  6x 11 61 8 507 335</p>  <p><b>71-39421-10</b> 3x 11 62 8 509 783</p> 	<p><b>70-31414-10</b> </p> 	<p><b>81-39382-00</b>  11 11 7 802 665 55x68 RD FPM</p>  <p><b>81-39379-00</b>  11 14 7 797 490 90x104 LD FPM</p> 



BMW

<p>Ltr.  N57 D30 B</p> <p>230 kW (313 PS)</p> <p>535 d (F07) 535 d (F10)</p> <p>09/11-02/17 </p>											
<p>3,0 N57 D30 B</p> <p>230 kW (313 PS)</p> <p>535 d (F11)</p> <p>09/11-02/17</p>			<p>08-41294-01 11 11 8 508 077</p> 	<p>61-38085-00 11 12 7 809 755 84,7 Ø 1,45 mm MLS</p> <p>61-38085-10 11 12 7 809 756 84,7 Ø 1,55 mm MLS</p> <p>61-38085-20 11 12 7 809 757 84,7 Ø 1,65 mm MLS</p> <p>61-38120-00 11 12 8 509 152 85 Ø 1,45 mm MLS</p> <p>61-38120-10 11 12 8 509 153 85 Ø 1,55 mm MLS</p> <p>61-38120-20 11 12 8 509 154 85 Ø 1,65 mm MLS</p>	<p>14-10398-02 11 12 8 513 130</p> 	<p>15-41288-01 11 12 8 515 732</p> 	<p>12-41303-01 11 34 7 812 926</p> 	<p>71-10390-00  6x 11 61 8 507 335</p> <p>71-41231-00  6x 11 61 7 807 480</p> <p>71-39421-10  3x 11 62 8 509 783</p> 	<p>70-31414-10</p> <p>71-41294-00 11 13 7 809 836</p> 	<p>81-39382-00  K 11 11 7 802 665 55x68 RD FPM</p> <p>81-39379-00  K 11 14 7 797 490 90x104 LD FPM</p>  	

























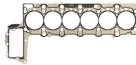
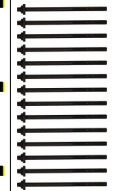
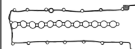
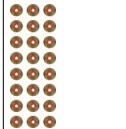

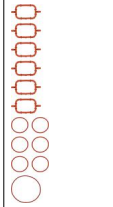
BMW

Ltr.	Motor	Power (kW/PS)	Model	Year	Image 1	Image 2	Image 3	Image 4	Image 5	Image 6	Image 7	Image 8	Image 9	Image 10	Image 11	Image 12
3,0	N57 D30 B	230 kW (313 PS)	740 d (F01, F02)	07/12-06/15												
									<p><b>61-38120-00</b> 11 12 8 509 152 85 Ø 1,45 mm MLS</p> <p><b>61-38120-10</b> 11 12 8 509 153 85 Ø 1,55 mm MLS</p> <p><b>61-38120-20</b> 11 12 8 509 154 85 Ø 1,65 mm MLS</p>	<p><b>14-10398-02</b> 11 12 8 513 130</p>	<p><b>15-41288-01</b> 11 12 8 515 732</p>	<p><b>12-41303-01</b> 11 34 7 812 926</p>	<p><b>71-10390-00</b>  6x 11 61 8 507 335</p> <p><b>71-39421-10</b>  3x 11 62 8 509 783</p>	<p><b>71-41294-00</b> 11 13 7 809 836</p>	<p><b>81-39382-00</b> <b>K</b>↔ 11 11 7 802 665 55x68 RD FPM</p> <p><b>81-39379-00</b> <b>K</b>↔ 11 14 7 797 490 90x104 LD FPM</p>	
3,0	N57 D30 C	280 kW (381 PS)	M 550 d (F10) M 550 d xDrive (F11) X5 M 50 d (E70) X6 M 50 d (E71, E72) 750 d (F01, F02, F03, F04)	08/11-02/17					<p><b>61-10193-00</b> 11 12 8 506 601 85 Ø 1,47 mm MLS</p> <p><b>61-10193-10</b> 11 12 8 506 602 85 Ø 1,57 mm MLS</p> <p><b>61-10193-20</b> 11 12 8 506 603 85 Ø 1,67 mm MLS</p>	<p><b>14-10017-01</b> 11 12 8 570 942</p>	<p><b>15-41288-01</b> 11 12 8 515 732</p>	<p><b>12-41303-01</b> 11 34 7 812 926</p>	<p><b>71-10390-00</b>  6x 11 61 8 507 335</p>	<p><b>71-41294-00</b> 11 13 7 809 836</p>	<p><b>81-39382-00</b> <b>K</b>↔ 11 11 7 802 665 55x68 RD FPM</p> <p><b>81-39379-00</b> <b>K</b>↔ 11 14 7 797 490 90x104 LD FPM</p>	
3,0	N57 D30 C	280 kW (381 PS)	X5 M 5.0 d (F15, F85) X6 M 50 d (F16, F86)	12/13-07/19			<p><b>71-39447-00</b> <b>K</b>↔ 11 14 7 797 491</p>	<p><b>61-10193-00</b> 11 12 8 506 601 85 Ø 1,47 mm MLS</p> <p><b>61-10193-10</b> 11 12 8 506 602 85 Ø 1,57 mm MLS</p> <p><b>61-10193-20</b> 11 12 8 506 603 85 Ø 1,67 mm MLS</p>	<p><b>14-10017-01</b> 11 12 8 570 942</p>	<p><b>15-41288-01</b> 11 12 8 515 732</p>	<p><b>12-41303-01</b> 11 34 7 812 926</p>	<p><b>71-10390-00</b>  6x 11 61 8 507 335</p>	<p><b>71-41294-00</b> 11 13 7 809 836</p>	<p><b>81-39382-00</b> <b>K</b>↔ 11 11 7 802 665 55x68 RD FPM</p> <p><b>81-39379-00</b> <b>K</b>↔ 11 14 7 797 490 90x104 LD FPM</p>		



BMW

Ltr.    1





















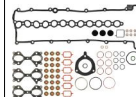



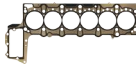
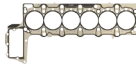
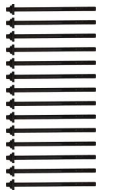
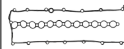
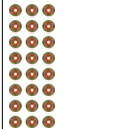

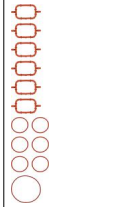

3,0 N57 306 D3 145 kW (197 PS)

										
	<p><b>02-37402-01</b> 11 12 0 393 750</p> 	<p><b>08-37408-01</b> 11 11 0 413 924</p> 	<p><b>04-10213-01</b> </p> 	<p><b>61-37645-00</b> 11 12 7 801 698 1,47 mm MLS</p> <p><b>61-37645-10</b> 11 12 7 801 699 1,57 mm MLS</p> <p><b>61-37645-20</b> 11 12 7 801 700 1,67 mm MLS</p> <p><b>61-37645-30</b> 11 12 7 801 701 1,77 mm MLS</p> 	<p><b>14-32311-01</b> 11 12 7 798 532</p> 	<p><b>71-37402-00</b> 11 12 7 796 378</p> 	<p><b>12-35172-02</b> 11 34 9 071 732</p> 	<p><b>11-77546-01</b> </p>  <p><b>71-33109-10</b>  6x 11 61 2 246 944</p> <p><b>71-77546-00</b>   6x 11 61 2 246 945</p> <p><b>71-37403-00</b>  3x 11 62 7 798 177</p> 	<p><b>71-37408-00</b> 11 13 7 802 669</p> 	<p><b>81-37002-00</b> </p> <p>11 11 8 604 931 55x68 AB RD PTFE</p>  <p><b>81-90033-00</b> </p> <p>11 14 7 794 168</p> 

BMW

Ltr.   





















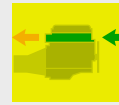















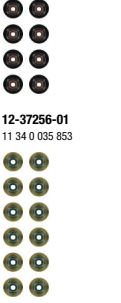



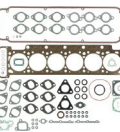







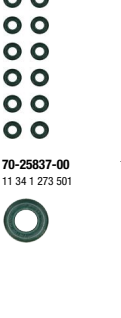



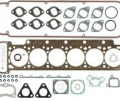

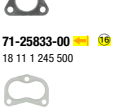





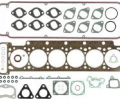







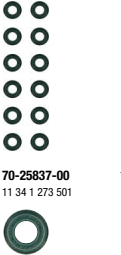

3,0 N57N 306 D2 170 kW (231 PS)

										
	<p><b>02-37402-02</b> 11 12 7 798 533</p> 	<p><b>08-37406-02</b> 11 11 7 798 531 1,47 mm MLS 1) ⇒ 02/06</p>   <p><b>08-37408-01</b> 11 11 0 413 924 1,67 mm MLS 1) 03/06→</p>  		<p><b>61-37640-00</b> 11 12 7 794 067 1,47 mm MLS 1) ⇒ 02/06</p> <p><b>61-37640-10</b> 11 12 7 794 068 1,57 mm MLS 1) ⇒ 02/06</p> <p><b>61-37640-20</b> 11 12 7 794 069 1,67 mm MLS 1) ⇒ 02/06</p> <p><b>61-37640-30</b> 11 12 7 794 857 1,77 mm MLS 1) ⇒ 02/06</p>  <p><b>61-37645-00</b> 11 12 7 801 698 1,47 mm MLS 1) 03/06→</p> <p><b>61-37645-10</b> 11 12 7 801 699 1,57 mm MLS 1) 03/06→</p> <p><b>61-37645-20</b> 11 12 7 801 700 1,67 mm MLS 1) 03/06→</p> <p><b>61-37645-30</b> 11 12 7 801 701 1,77 mm MLS 1) 03/06→</p> 	<p><b>14-32311-01</b> 11 12 7 798 532</p> 	<p><b>71-37402-00</b> 11 12 7 796 378</p> 	<p><b>12-35172-02</b> 11 34 9 071 732</p> 	<p><b>11-77546-01</b> </p>  <p><b>71-33109-10</b>  6x 11 61 2 246 944</p> <p><b>71-77546-00</b>   6x 11 61 2 246 945</p> <p><b>71-37403-00</b>  3x 11 62 7 798 177</p> 	<p><b>71-37406-00</b> 11 13 7 798 122 1) ⇒ 02/06</p>  <p><b>71-37408-00</b> 11 13 7 802 669 1) 03/06→</p> 	<p><b>81-37002-00</b> </p> <p>11 11 8 604 931 55x68 AB RD PTFE</p>  <p><b>81-90033-00</b> </p> <p>11 14 7 794 168</p> 

BMW



Ltr.																
3,0	N57N 306 D3 N57N 306 D5	145-210 kW (197-286 PS)		<b>02-37402-01</b> 11 12 0 393 750	<b>08-37408-01</b> 11 11 0 413 924		<b>61-37645-00</b> 11 12 7 801 698 1,47 mm MLS <b>1</b>	<b>61-37645-10</b> 11 12 7 801 699 1,57 mm MLS <b>2</b>	<b>61-37645-20</b> 11 12 7 801 700 1,67 mm MLS <b>3</b>	<b>61-37645-30</b> 11 12 7 801 701 1,77 mm MLS 	<b>14-32311-01</b> 11 12 7 798 532 	<b>71-37402-00</b> 11 12 7 796 378 	<b>12-35172-02</b> 11 34 9 071 732 	<b>11-77546-01</b> <b>1</b> 6x <b>71-33109-10</b> 6x <b>11 61 2 246 944</b> <b>71-77546-00</b> <b>1</b> 6x <b>11 61 2 246 945</b> <b>71-37403-00</b> <b>3</b> x <b>11 62 7 798 177</b>	<b>71-37408-00</b> 11 13 7 802 669 	<b>81-37002-00</b> <b>K</b> 11 11 8 604 931 55x68 AB RD PTFE <b>81-90033-00</b> <b>K</b> 11 14 7 794 168 
3,0	S50 B30 (306S1) S50 B30 (306S2)	176-217 kW (239-295 PS)	M3 (E36) M3 3.0 (E36)	11/92-12/95	<b>02-34090-02</b> 11 12 1 402 384 		<b>61-34090-00</b> 11 12 1 405 748 87 Ø 1,75 mm 				<b>71-33828-00</b> 11 12 1 404 398 	<b>71-33829-00</b> <b>2</b> x 11 12 1 317 386 	<b>12-26058-01</b> 11 34 9 059 172 	<b>71-34147-00</b> <b>6</b> x 11 62 1 317 109	<b>71-27698-10</b> 11 13 1 437 237 	<b>81-17404-10</b> <b>K</b> 11 14 2 249 532 48x65 AB SL RD PTFE (Polytetrafluorethylen)/ACM (Polyacryl-Kautschuk)  <b>81-20745-00</b> <b>K</b> 11 14 2 249 533 90x110 AB SL LD PTFE (Polytetrafluorethylen)/ACM (Polyacryl-Kautschuk) 
3,0	S55 B30 A	317-368 kW (431-500 PS)	M3 (F30, F35, F80) M4 CS (F32, F82) M4 (F32, F82) M4 (F33, F83) M4 GTS (F32, F82)	03/14			<b>61-10280-00</b> 11 12 7 849 620 85 Ø 1,2 mm MLS <b>61-10280-10</b> 11 12 7 849 621 85 Ø 1,5 mm MLS <b>1</b>				<b>15-10002-01</b> 11 12 7 587 804 	<b>12-36866-01</b> 11 34 0 034 068 	<b>11-12910-01</b> <b>1</b>  <b>71-41318-00</b> <b>1</b> <b>1</b> 11 61 7 588 624 <b>71-12314-00</b> <b>2</b> x 11 65 7 847 039 	<b>71-41291-00</b> 11 13 7 600 482 	<b>81-10378-00</b> <b>K</b> 11 11 8 618 864 65x79 RD FPM  <b>81-40292-00</b> <b>K</b> 11 11 7 587 168 90x110 A LD FPM 	

















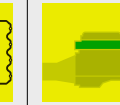
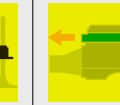
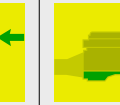

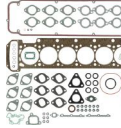



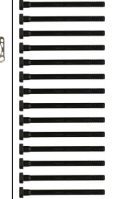

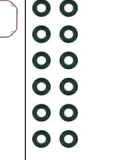





BMW

Ltr.															
3,0	S58 B30 A	375 kW (510 PS)	X3 M Competition (G01, F97)	03/19 <b>[NEW]</b>											
					02-11365-01	08-11365-01		61-11365-00 11 12 8 088 729 84,5 Ø 0,95 mm MLS	14-13082-03 11 12 8 644 675 (14x)	71-21988-00 11 12 7 886 546	12-36866-03 11 34 0 038 719	71-12439-00  6x 11 61 8 637 800	70-31414-10 	81-37002-00  11 11 8 604 931 55x68 AB RD PTFE	
															
3,2	M30 B32 M30 B32 (330EL) M30 B32 (633EL) M30 B32 (732EL) M30 B32 (733EL)	130-152 kW (179-207 PS)	633 CSI (E24) 732 I/(E23) 732 I/733 I (E23)	05/77	 02-24200-17 11 12 9 065 713  09/80	 08-22601-02 11 00 1 267 942	 15-22603-02  11 141 735 047	 61-24200-50 11 12 9 065 638 90 Ø 1,75 mm		 14-32000-02 11 12 0 621 144(14x)	 71-25221-30 11 12 1 730 231	 12-25837-03 11 34 9 059 170	 71-24887-10  6x 11 61 1 730 788	71-22601-20 11 13 1 315 085	81-16004-10  11 14 1 715 100 42x62 A SL RD FPM
					 02-24200-18 11 12 9 065 714  10/80 →						 70-25837-00 11 34 1 273 501	 71-22012-20  16 2x 18 11 1 723 843	 71-25833-00  16 18 11 1 245 500	 81-20745-40  11 14 2 245 364 90x110 A SL LD FPM	
					 02-24200-18 11 12 9 065 714	 08-22601-02 11 00 1 267 942	 15-22603-02  11 141 735 047	 61-24200-50 11 12 9 065 638 90 Ø 1,75 mm		 14-32000-02 11 12 0 621 144(14x)	 71-25221-30 11 12 1 730 231	 12-25837-03 11 34 9 059 170	 71-24887-10  6x 11 61 1 730 788	71-22601-20 11 13 1 315 085	81-16004-10  11 14 1 715 100 42x62 A SL RD FPM
					 02-24200-18 11 12 9 065 714						 70-25837-00 11 34 1 273 501	 71-22012-20  16 2x 18 11 1 723 843	 71-25833-00  16 18 11 1 245 500	 81-20745-40  11 14 2 245 364 90x110 A SL LD FPM	











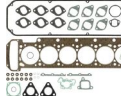



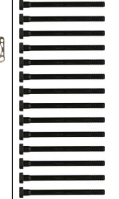

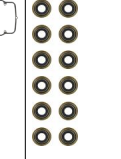





BMW

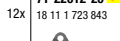









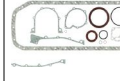

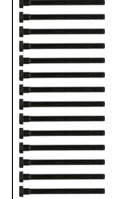

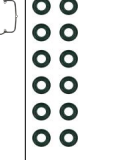
Ltr.  M30 B32 147 kW (200 PS) 3.2 Li (E3)  10/75-04/77

										
	02-24200-17 11 12 9 065 713 	08-22601-02 11 00 1 267 942 	15-22603-02  11 14 1 735 047 	61-24200-50 11 12 9 065 638 90 Ø 1,75 mm 	14-32000-02 11 12 0 621 144(14x) 	71-25221-30 11 12 1 730 231 	12-25837-03 11 34 9 059 170  70-25837-00 11 34 1 273 501 	71-24887-10  6x 11 61 1 730 788  71-23713-10  6x 11 62 1 723 851  71-22012-20   2x 18 11 1 723 843  71-25833-00   18 11 1 245 500 	71-22601-20 11 13 1 315 085 	81-16004-10  11 14 1 715 100 42x62 A SL RD FPM  81-20745-40  11 14 2 245 364 90x110 A SL LD FPM 

























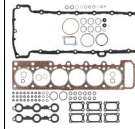











3,2 M30 B32 (315/1A) 152 kW (206 PS)



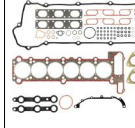

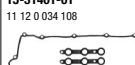
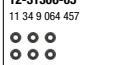

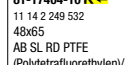









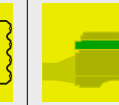
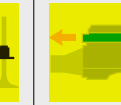
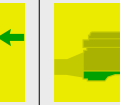

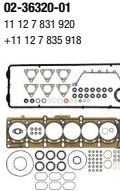
	02-24200-11 11 12 9 065 705 	08-22601-02 11 00 1 267 942 	15-22603-02  11 14 1 735 047 	61-24200-50 11 12 9 065 638 90 Ø 1,75 mm 	14-32000-02 11 12 0 621 144(14x) 	71-22501-20 11 12 1 730 935 	12-21025-02 11 34 1 256 556 (12x)  70-21025-00 11 34 1 256 556 	71-24887-10  6x 11 61 1 730 788  71-23713-10  6x 11 62 1 723 851  71-22012-20   2x 18 11 1 723 843 	71-22601-20 11 13 1 315 085 	81-16004-10  11 14 1 715 100 42x62 A SL RD FPM  81-20745-40  11 14 2 245 364 90x110 A SL LD FPM 
--	---	---	---	--	--	---	--	--	---	---

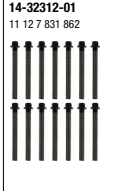
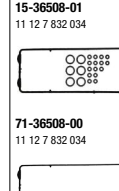
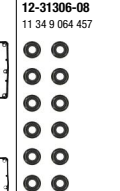
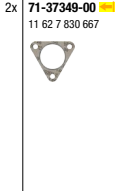
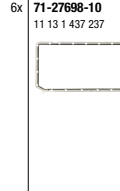
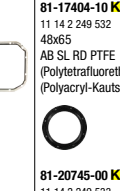
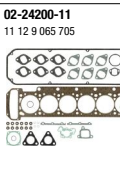
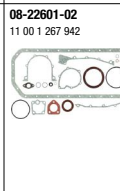
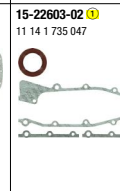
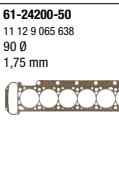
3,2 M30 B32 (326TA) 185 kW (252 PS) 745 i (E32) 04/80-04/83

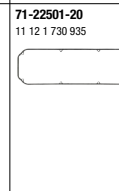
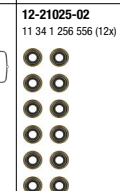
		08-27468-02 11 00 9 058 775 	15-22603-02  11 14 1 735 047 		14-32000-02 11 12 0 621 144(14x) 	71-22501-20 11 12 1 730 935 	12-25837-03 11 34 9 059 170  70-25837-00 11 34 1 273 501 	71-24887-10  6x 11 61 1 730 788  71-27121-10  2x 11 62 1 723 656 	71-27468-10 11 13 1 722 085 	81-16004-10  11 14 1 715 100 42x62 A SL RD FPM  81-20745-40  11 14 2 245 364 90x110 A SL LD FPM 
--	--	--	--	--	---	---	---	--	---	--

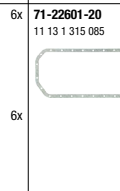
BMW

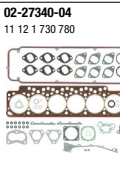
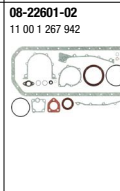
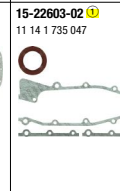
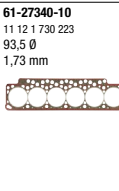
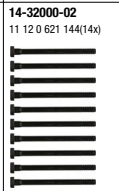
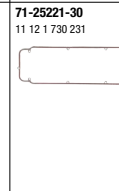
Ltr.														
3,2	S50 B32 S50 B32 (326S1) S50 B32 (326S3) S50 B32 (326S4) S50 326 S4	236-252 kW (321-343 PS)	M3 (E36) Z3 M 3.2 (E36)	10/95						 <b>71-33828-00</b> 11 12 1 404 358	 <b>12-31306-05</b> 11 34 9 064 457	 <b>71-34147-00</b> 11 62 1 317 109	 <b>71-27698-10</b> 11 13 1 437 237	 <b>81-17404-50 K↔</b> 11 14 1 265 431 48x65 AB SL RD FPM  <b>81-20745-00 K↔</b> 11 14 2 249 533 90x110 AB SL LD PTFE (Polytetrafluorethylen)/ACM (Polyacryl-Kautschuk) 
3,2	S52 B32	179 kW (243 PS)									 <b>12-31306-05</b> 11 34 9 064 457	 <b>71-34147-00</b> 11 62 1 317 109	 <b>71-27698-10</b> 11 13 1 437 237	 <b>81-17404-50 K↔</b> 11 14 1 265 431 48x65 AB SL RD FPM  <b>81-20745-00 K↔</b> 11 14 2 249 533 90x110 AB SL LD PTFE (Polytetrafluorethylen)/ACM (Polyacryl-Kautschuk) 
3,2	S52 B32 (326S2)	176-179 kW (239-243 PS)	M3 3.2 (E36) Z3 M 3.2 (E36)	06/96-06/00						 <b>15-31401-01</b> 11 12 0 034 108	 <b>12-31306-05</b> 11 34 9 064 457	 <b>71-31403-00</b> 11 61 1 740 069	 <b>71-31404-00</b> 11 62 1 744 252	 <b>81-17404-10 K↔</b> 11 14 2 249 532 48x65 AB SL RD PTFE (Polytetrafluorethylen)/ACM (Polyacryl-Kautschuk)  <b>81-20745-40 K↔</b> 11 14 2 245 364 90x110 A.SL LD FPM 

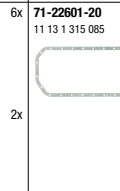
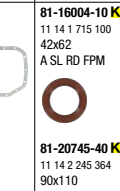
BMW															
3,2	S54 B32 (326S4)	235-265 kW (320-360 PS)	M3 CSL (E46) M3 (E46) M3 3.2 (E46) Z3 M (E36) Z3 M 3.2 (E36) Z3 M 3.2 i (E36) Z3 3.2 i (E36) Z4 M (E86) Z4 M 3.2 (E85) Z4 M 3.2 (E86) Z4 3.2i (E85)	07/00-12/08							2x		6x		
					02-36320-01 11 12 7 831 920 +11 12 7 835 918	08-27698-08 11 11 0 302 722	61-36320-00 11 12 7 832 022 0,64 mm MLS	14-32312-01 11 12 7 831 862	15-36508-01 11 12 7 832 034	12-31306-08 11 34 9 064 457		71-37349-00 11 62 7 830 667		71-27698-10 11 13 1 437 237	81-17404-10 K↔ 11 14 2 249 532 48x65 AB SL RD PTFE (Polytetrafluorethylen)/ACM (Polyacryl-Kautschuk)
															81-20745-00 K↔ 11 14 2 249 533 90x110 AB SL LD PTFE (Polytetrafluorethylen)/ACM (Polyacryl-Kautschuk)
3,3	M30 B33 (35/40 INAT)	140 kW (190 PS)	3.3 L (E3)	01/74-09/76									6x		
					02-24200-11 11 12 9 065 705	08-22601-02 11 00 1 267 942	15-22603-02 11 14 1 735 047	61-24200-50 11 12 9 065 638 90 Ø 1,75 mm	14-32000-02 11 12 0 621 144(14x)	71-22501-20 11 12 1 730 935	12-21025-02 11 34 1 256 556 (12x)	71-24887-10 11 61 1 730 788		71-22601-20 11 13 1 315 085	81-16004-10 K↔ 11 14 1 715 100 42x62 A SL RD FPM
															81-20745-40 K↔ 11 14 2 245 364 90x110 A SL LD FPM
3,4	M30 B34 (346EC) M30 B34 (346KA)	136-160 kW (185-218 PS)	735 i (E23)	09/82-09/86									6x		
					02-27340-04 11 12 1 730 780	08-22601-02 11 00 1 267 942	15-22603-02 11 14 1 735 047	61-27340-10 11 12 1 730 223 93,5 Ø 1,73 mm	14-32000-02 11 12 0 621 144(14x)	71-25221-30 11 12 1 730 231	12-25837-03 11 34 9 059 170	71-24887-10 11 61 1 730 788		71-22601-20 11 13 1 315 085	81-16004-10 K↔ 11 14 1 715 100 42x62 A SL RD FPM
															81-20745-40 K↔ 11 14 2 245 364 90x110 A SL LD FPM

BMW

Ltr.   

3,4 M30 B34 (346EC) 136-162 kW (185-220 PS) M 535 i (E28) 12/84-12/87  
M30 B34 (346KA) 635 CSI (E24)



02-27340-04  
11 12 1 730 780  
11 12 9 059 238  
08/86

02-27340-05  
11 12 9 059 238  
08/86

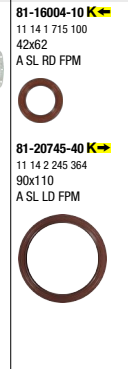
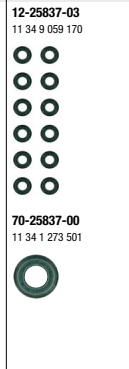
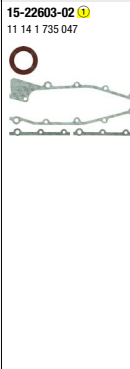
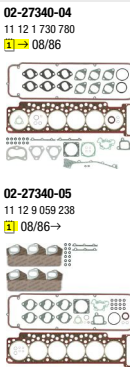

3,4 M30 B34 (346EC) 141 kW (192 PS) 635 CSI (E24) 12/77-04/89

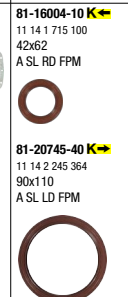
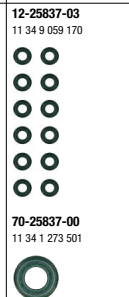
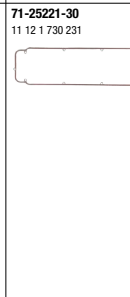
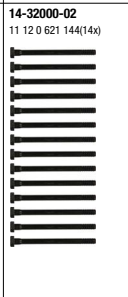
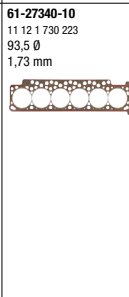

3,4 M30 B34 (346KB) 155 kW (211 PS) 535 i (E34) 06/86-02/93  
635 CSI (E24)  
735 i.L (E32)

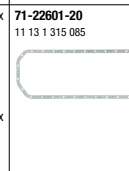
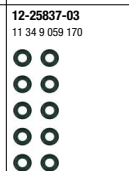
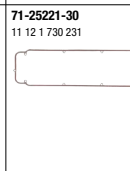
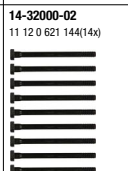
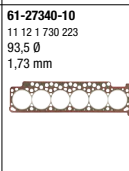

02-27340-05  
11 12 9 059 238

08-22601-02  
11 00 1 267 942

15-22603-02  
11 14 1 735 047

61-27340-10  
11 12 1 730 223  
93,5 Ø  
1,73 mm

14-32000-02  
11 12 0 621 144(14x)

71-25221-30  
11 12 1 730 231

12-25837-03  
11 34 9 059 170

71-24887-10  
11 61 1 730 788

71-22601-20  
11 13 1 315 085

81-16004-10  
11 14 1 715 100  
42x62  
A SL RD FPM













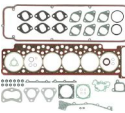



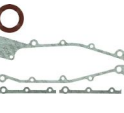

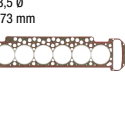



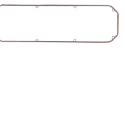

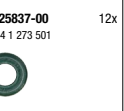

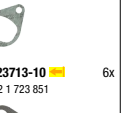
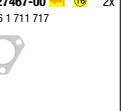









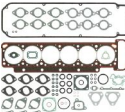

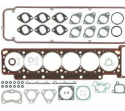

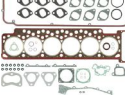

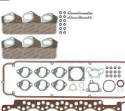

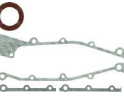

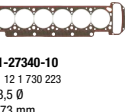

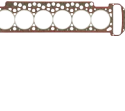







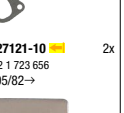

81-20745-40  
11 14 2 245 364  
90x110  
A SL LD FPM

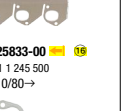
BMW

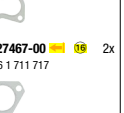

Ltr.  M30 B35 (Motronic,10:1) 160 kW (218 PS)



















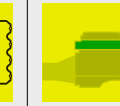
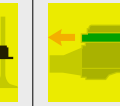
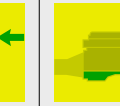

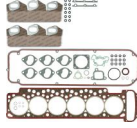
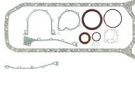





1

	 <p><b>02-27340-04</b> 11 12 1 730 780</p> 	 <p><b>08-22601-02</b> 11 00 1 267 942</p> 	 <p><b>15-22603-02</b>  11 14 1 735 047</p> 	 <p><b>61-27340-10</b> 11 12 1 730 223 93,5 Ø 1,73 mm</p> 	 <p><b>14-32000-02</b> 11 12 0 621 144(14x)</p> 	 <p><b>71-25221-30</b> 11 12 1 730 231</p> 	 <p><b>12-25837-03</b> 11 34 9 059 170</p>  <p><b>70-25837-00</b> 11 34 1 273 501</p> 	 <p><b>71-24887-10</b>  6x 11 61 1 730 788</p>  <p><b>71-23713-10</b> 6x 11 62 1 723 851</p>  <p><b>71-27467-00</b>  2x 11 76 1 711 717</p> 	 <p><b>71-22601-20</b> 11 13 1 315 085</p> 	 <p><b>81-16004-10</b>  11 14 1 715 100 42x62 A SL RD FPM</p>  <p><b>81-20745-40</b>  11 14 2 245 364 90x110 A SL LD FPM</p> 
<p>3,4-3,5 M30 B35 (L-Jetronic,10:1) 160 kW (218 PS)</p>	<p><b>02-25220-03</b> 11 12 9 059 247  → 09/80</p>  <p><b>02-25220-04</b> 11 12 1 730 933  09/80 →  → 05/82</p>  <p><b>02-27340-04</b> 11 12 1 730 780  05/82 →  → 08/86</p>  <p><b>02-27340-05</b> 11 12 9 059 238  08/86 →</p> 	<p><b>08-22601-02</b> 11 00 1 267 942</p> 	<p><b>15-22603-02</b>  11 14 1 735 047</p> 	<p><b>61-25220-20</b> 11 12 1 730 951 94,5 Ø 1,9 mm  → 05/82</p>  <p><b>61-27340-10</b> 11 12 1 730 223 93,5 Ø 1,73 mm  05/82 →</p> 	<p><b>14-32000-02</b> 11 12 0 621 144(14x)</p> 	<p><b>71-22501-20</b> 11 12 1 730 935  → 09/80</p>  <p><b>71-25221-30</b> 11 12 1 730 231  09/80 →</p> 	<p><b>12-25837-03</b> 11 34 9 059 170</p>  <p><b>70-25837-00</b> 11 34 1 273 501</p> 	<p><b>71-24887-10</b>  6x 11 61 1 730 788</p>  <p><b>71-23713-10</b> 6x 11 62 1 723 851  → 04/82</p>  <p><b>71-27121-10</b> 2x 11 62 1 723 656  05/82 →</p>  <p><b>71-25833-00</b>  18 11 1 245 500  10/80 →</p>  <p><b>71-27467-00</b>  2x 11 76 1 711 717</p> 	<p><b>81-16004-10</b>  11 14 1 715 100 42x62 A SL RD FPM</p>  <p><b>81-20745-40</b>  11 14 2 245 364 90x110 A SL LD FPM</p> 	











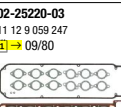
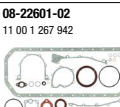

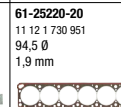
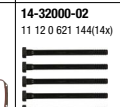
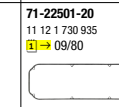
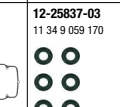

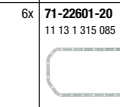
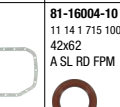



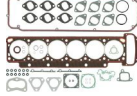

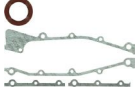





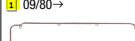



BMW

Ltr.   

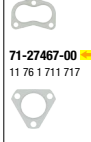









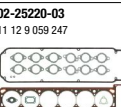
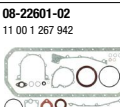

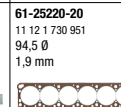
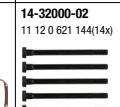
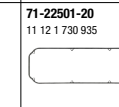
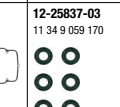

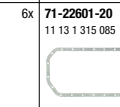
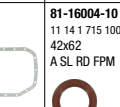



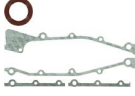



3,4-3,5 M30 B35 (Motronic,9.2:1) 162 kW (220 PS)

										
	<p><b>02-27340-05</b> 11 12 9 059 238</p> 	<p><b>08-27468-02</b> 11 00 9 058 775</p> 	<p><b>15-22603-02</b> </p> <p>11 14 1 735 047</p> 	<p><b>61-27340-10</b> 11 12 1 730 223 93,5 Ø 1,73 mm</p> 	<p><b>14-32000-02</b> 11 12 0 621 144(14x)</p> 	<p><b>71-25221-30</b> 11 12 1 730 231</p> 	<p><b>12-25837-03</b> 11 34 9 059 170</p>  <p><b>70-25837-00</b> 11 34 1 273 501</p> 	<p><b>71-27213-10</b>  6x 11 61 1 726 016</p> <p><b>71-27121-10</b>  2x 11 62 1 723 656</p> 	<p><b>71-27468-10</b> 11 13 1 722 695</p> 	<p><b>81-16004-10</b>  11 14 1 715 100 42x62 A SL RD FPM</p>  <p><b>81-20745-40</b>  11 14 2 245 364 90x110 A SL LD FPM</p> 

3,5 M30 B35 (346EC) 160 kW (218 PS) 635 CSI (E24) 735 i (E23) 06/78-09/82

















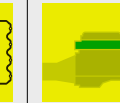
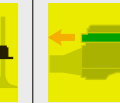
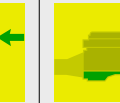
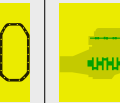
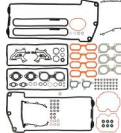
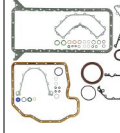
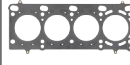
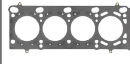
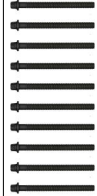























										
	<p><b>02-25220-03</b> 11 12 9 059 247  09/80</p>  <p><b>02-25220-04</b> 11 12 1 730 933  09/80→</p> 	<p><b>08-22601-02</b> 11 00 1 267 942</p> 	<p><b>15-22603-02</b> </p> <p>11 14 1 735 047</p> 	<p><b>61-25220-20</b> 11 12 1 730 951 94,5 Ø 1,9 mm</p> 	<p><b>14-32000-02</b> 11 12 0 621 144(14x)</p> 	<p><b>71-22501-20</b> 11 12 1 730 935  09/80</p>  <p><b>71-25221-30</b> 11 12 1 730 231  09/80→</p> 	<p><b>12-25837-03</b> 11 34 9 059 170</p>  <p><b>70-25837-00</b> 11 34 1 273 501</p> 	<p><b>71-24887-10</b>  6x 11 61 1 730 788</p> <p><b>71-23713-10</b>  6x 11 62 1 723 651</p> <p><b>71-25833-00</b>  10/80→</p>  <p><b>71-27467-00</b>  10/80→ 2x 11 76 1 711 717</p> 	<p><b>71-22601-20</b> 11 13 1 315 085</p> 	<p><b>81-16004-10</b>  11 14 1 715 100 42x62 A SL RD FPM</p>  <p><b>81-20745-40</b>  11 14 2 245 364 90x110 A SL LD FPM</p> 

3,5 M30 B35 (356EA) 160 kW (218 PS)











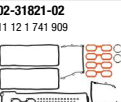

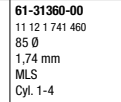
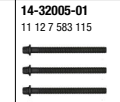
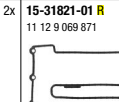
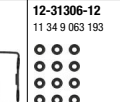

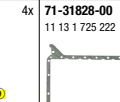

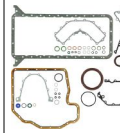
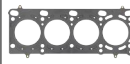
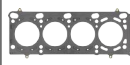
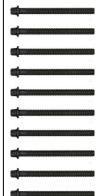





















										
	<p><b>02-25220-03</b> 11 12 9 059 247</p> 	<p><b>08-22601-02</b> 11 00 1 267 942</p> 	<p><b>15-22603-02</b> </p> <p>11 14 1 735 047</p> 	<p><b>61-25220-20</b> 11 12 1 730 951 94,5 Ø 1,9 mm</p> 	<p><b>14-32000-02</b> 11 12 0 621 144(14x)</p> 	<p><b>71-22501-20</b> 11 12 1 730 935</p> 	<p><b>12-25837-03</b> 11 34 9 059 170</p>  <p><b>70-25837-00</b> 11 34 1 273 501</p> 	<p><b>71-24887-10</b>  6x 11 61 1 730 788</p> <p><b>71-23713-10</b>  6x 11 62 1 723 651</p> <p><b>71-27467-00</b>  10/80→ 2x 11 76 1 711 717</p> 	<p><b>71-22601-20</b> 11 13 1 315 085</p> 	<p><b>81-16004-10</b>  11 14 1 715 100 42x62 A SL RD FPM</p>  <p><b>81-20745-40</b>  11 14 2 245 364 90x110 A SL LD FPM</p> 

BMW

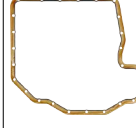























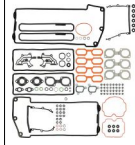

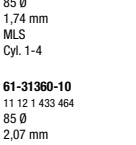
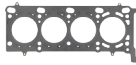





















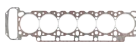
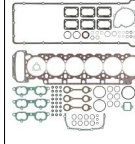

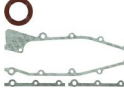
Ltr.  M62 B35 TU 175-180 kW (238-245 PS)  1

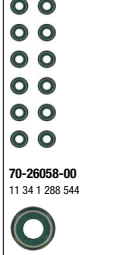
												
3,5	M62 B35 TU	175-180 kW (238-245 PS)										
			<p><b>02-33396-01</b> 11 12 0 004 553</p> 	<p><b>08-31828-01</b> 11 11 9 070 240</p> 		<p><b>61-31360-00</b> 11 12 1 741 460 85 Ø 1,74 mm MLS Cyl. 1-4</p> <p><b>61-31360-10</b> 11 12 1 433 464 85 Ø 2,07 mm MLS Cyl. 1-4</p>  <p><b>61-31365-00</b> 11 12 1 741 462 85 Ø 1,74 mm MLS Cyl. 5-8</p> <p><b>61-31365-10</b> 11 12 1 433 468 85 Ø 2,07 mm MLS Cyl. 5-8</p> 	<p><b>14-32005-01</b> 11 12 7 583 115</p> 	<p><b>15-33396-01 R</b> 11 12 0 034 104 Cyl. 1-4</p>  <p><b>15-33397-01 L</b> 11 12 0 034 105 Cyl. 5-8</p> 	<p><b>12-31306-12</b> 11 34 9 063 193</p>  <p><b>70-31306-00</b> 11 34 2 245 151</p> 	<p><b>71-31853-00</b>   4x 11 61 1 433 328</p>  <p><b>71-31826-00</b>     11 61 1 729 727</p>  <p><b>71-31827-00</b>     11 61 1 729 728</p>  <p><b>71-31834-10</b>   11 62 7 505 789</p>  <p><b>71-31836-10</b>   11 62 7 509 677</p> 	<p><b>71-31828-00</b> 11 13 1 725 222</p>  <p><b>71-31837-00</b>   11 13 1 436 324</p> 	<p><b>81-17404-50 K</b>   11 14 1 265 431 48x65 AB SL RD FPM</p>  <p><b>81-27373-00 K</b>   11 14 1 713 730 100x125 A SL LD FPM</p> 

3,5 M62 B35 (358S1) 173 kW (235 PS) 535 i (E39) 03/96-08/98 735 i L (E38)















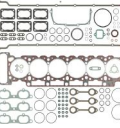







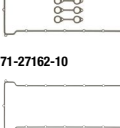



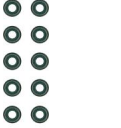

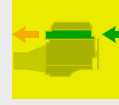

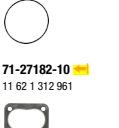









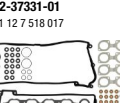



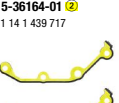

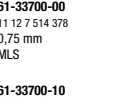
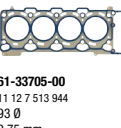
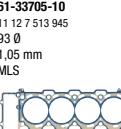
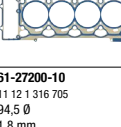

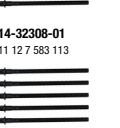

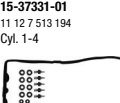
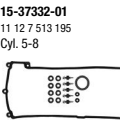

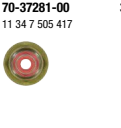













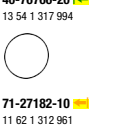













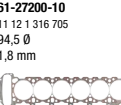

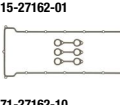



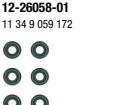



												
3,5	M62 B35 (358S1)	173 kW (235 PS)	535 i (E39) 735 i L (E38)	03/96-08/98								
			<p><b>02-31821-02</b> 11 12 1 741 909</p> 	<p><b>08-31828-01</b> 11 11 9 070 240</p> 		<p><b>61-31360-00</b> 11 12 1 741 460 85 Ø 1,74 mm MLS Cyl. 1-4</p> <p><b>61-31360-10</b> 11 12 1 433 464 85 Ø 2,07 mm MLS Cyl. 1-4</p>  <p><b>61-31365-00</b> 11 12 1 741 462 85 Ø 1,74 mm MLS Cyl. 5-8</p> <p><b>61-31365-10</b> 11 12 1 433 468 85 Ø 2,07 mm MLS Cyl. 5-8</p> 	<p><b>14-32005-01</b> 11 12 7 583 115</p> 	<p><b>15-31821-01 R</b> 11 12 9 069 871</p>  <p><b>15-31822-01 L</b> 11 12 9 069 872</p> 	<p><b>12-31306-12</b> 11 34 9 063 193</p>  <p><b>70-31306-00</b> 11 34 2 245 151</p> 	<p><b>71-31853-00</b>   4x 11 61 1 433 328</p>  <p><b>71-31826-00</b>     11 61 1 729 727</p>  <p><b>71-31827-00</b>     11 61 1 729 728</p>  <p><b>71-31834-10</b>   11 62 7 505 789</p>  <p><b>71-31836-10</b>   11 62 7 509 677</p> 	<p><b>71-31828-00</b> 11 13 1 725 222</p>  <p><b>71-31837-00</b>   11 13 1 436 324</p> 	<p><b>81-17404-50 K</b>   11 14 1 265 431 48x65 AB SL RD FPM</p>  <p><b>81-27373-00 K</b>   11 14 1 713 730 100x125 A SL LD FPM</p> 

BMW

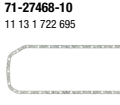

Ltr.														
3,5	M62 B35 (358S2)	175-180 kW (238-245 PS)	535 i (E39) 735 i, iL (E38)	09/98-06/03				 <b>61-31360-00</b> 11 12 1 741 460 85 Ø 1,74 mm MLS Cyl. 1-4  <b>61-31360-10</b> 11 12 1 433 464 85 Ø 2,07 mm MLS Cyl. 1-4   <b>61-31365-00</b> 11 12 1 741 462 85 Ø 1,74 mm MLS Cyl. 5-8  <b>61-31365-10</b> 11 12 1 433 468 85 Ø 2,07 mm MLS Cyl. 5-8	 <b>14-32005-01</b> 11 12 7 583 115	2x  <b>15-33396-01 R</b> 11 12 0 034 104   <b>15-33397-01 L</b> 11 12 0 034 105	 <b>12-31306-12</b> 11 34 9 063 193   <b>70-31306-00</b> 11 34 2 245 151	2x  <b>71-31853-00</b>  11 61 1 433 328   <b>71-31826-00</b>  11 61 1 729 727   <b>71-31827-00</b>  11 61 1 729 728   <b>71-31834-10</b>  11 62 7 505 789   <b>71-31836-10</b>  11 62 7 509 677	4x  <b>71-31828-00</b> 11 13 1 725 222   <b>71-31837-00</b>  11 13 1 436 324	3x  <b>81-17404-50</b>  11 14 1 265 431 48x65 AB SL RD FPM   <b>81-27373-00</b>  11 14 1 713 730 100x125 A SL LD FPM
3,5	M88	204 kW (278 PS)	M1 (E26)	05/79-05/83				 <b>61-27200-10</b> 11 12 1 316 705 94,5 Ø 1,8 mm						
3,5	M88 B35 (356ED) S38 B35 AF S38 B35 (356EB) S38 B35 (356ED) S38 B35 (356EE) S38 B35 (356EY)	191-211 kW (260-287 PS)	M 635 CSI (E24) 535 i (E28)	04/84				 <b>61-27200-10</b> 11 12 1 316 705 94,5 Ø 1,8 mm	 <b>15-31124-01</b> 11 12 1 317 689 +11 12 1 312 173 (3x)	 <b>12-26058-01</b> 11 34 9 059 172   <b>70-26058-00</b> 11 34 1 288 544	2x  <b>71-27182-10</b>  11 62 1 312 961	6x  <b>71-22601-20</b> 11 13 1 315 085	 <b>81-16004-10</b>  11 14 1 715 100 42x62 A SL RD FPM   <b>81-20745-40</b>  11 14 2 245 364 90x110 A SL LD FPM	



BMW

<p>Ltr.   </p> <p>3,5 S38 B36 (366S2) 210-232 kW (286-316 PS)</p>		 <p><b>02-27200-03</b> 11 12 9 059 244</p> 	 <p><b>08-27468-03</b> 11 11 1 315 106</p> 		 <p><b>61-27200-10</b> 11 12 1 316 705 94,5 Ø 1,8 mm</p> 		 <p><b>15-27162-01</b> 13 54 1 317 994</p>  <p><b>71-27162-10</b></p>  <p><b>71-27163-10</b> 3x 11 12 1 312 173</p> 	 <p><b>12-26058-01</b> 11 34 9 059 172</p>  <p><b>70-26058-00</b> 11 34 1 288 544</p> 	 <p><b>40-76766-20</b>  6x 13 54 1 317 994</p>  <p><b>71-27182-10</b>  6x 11 62 1 312 961</p> 	 <p><b>71-27468-10</b> 11 13 1 722 695</p> 	 <p><b>81-17404-50 K</b>  11 14 1 265 431 48x65 AB SL RD FPM</p>  <p><b>81-20745-00 K</b>  11 14 2 249 533 90x110 AB SL LD PTFE (Polytetrafluorethylen)/ACM (Polyacryl-Kautschuk)</p> 
<p>3,6 N62 B36 A 200 kW (272 PS) 735 iLi (E65,E66) 11/01-02/05</p>		 <p><b>02-37331-01</b> 11 12 7 518 017</p> 	 <p><b>08-34067-01</b> 11 11 7 551 866</p> 	 <p><b>15-36164-01</b>  11 14 1 439 717</p> 	 <p><b>61-33700-00</b> 2x 11 12 7 514 378 0,75 mm MLS</p>  <p><b>61-33700-10</b> 2x 11 12 7 514 379 1,05 mm MLS</p>  <p><b>61-33705-00</b> 11 12 7 513 944 93 Ø 0,75 mm MLS</p> <p><b>61-33705-10</b> 11 12 7 513 945 93 Ø 1,05 mm MLS</p> 	 <p><b>14-32308-01</b> 1x 11 12 7 583 113</p>  <p><b>14-32308-01</b> 2x 11 12 7 583 113</p> 	 <p><b>15-37331-01</b> 11 12 7 513 194 Cyl. 1-4</p>  <p><b>15-37332-01</b> 2x 11 12 7 513 195 Cyl. 5-8</p> 	 <p><b>12-37281-01</b> 2x 11 34 0 054 492</p>  <p><b>70-37281-00</b> 32x 11 34 7 505 417</p> 	 <p><b>71-39428-00</b>  2x 11 61 7 521 181</p>  <p><b>71-31834-10</b>  3x 11 62 7 505 789  09/03</p>  <p><b>71-37337-00</b>  32x 11 62 7 505 788  09/03</p>  <p><b>71-31834-10</b>  4x 11 62 7 505 789  10/03→</p>  <p><b>71-31834-10</b>  4x 11 62 7 505 789</p> 	 <p><b>71-34067-00</b> 11 13 7 506 774</p>  <p><b>71-34069-00</b> 11 13 7 545 293</p> 	 <p><b>81-34062-00 K</b>  11 14 7 647 380 45x75 RD FPM</p>  <p><b>81-90001-00 K</b>  11 14 7 512 101 100 Ø LD PTFE</p> 
<p>3,6 S38 B36 (366S1) 232 kW (315 PS) M5 (E34) 09/88-03/92</p>		 <p><b>02-27200-03</b> 11 12 9 059 244</p> 	 <p><b>08-27468-03</b> 11 11 1 315 106</p> 		 <p><b>61-27200-10</b> 11 12 1 316 705 94,5 Ø 1,8 mm</p> 		 <p><b>15-27162-01</b> 13 54 1 317 994</p>  <p><b>71-27162-10</b></p>  <p><b>71-27163-10</b> 3x 11 12 1 312 173</p> 	 <p><b>12-26058-01</b> 2x 11 34 9 059 172</p>  <p><b>70-26058-00</b> 24x 11 34 1 288 544</p> 	 <p><b>40-76766-20</b>  6x 13 54 1 317 994</p>  <p><b>71-27182-10</b>  6x 11 62 1 312 961</p> 	 <p><b>71-27468-10</b> 11 13 1 722 695</p> 	 <p><b>81-17404-50 K</b>  11 14 1 265 431 48x65 AB SL RD FPM</p>  <p><b>81-20745-00 K</b>  11 14 2 249 533 90x110 AB SL LD PTFE (Polytetrafluorethylen)/ACM (Polyacryl-Kautschuk)</p> 

BMW

Ltr.   

3,8 S38 B38 (386S1) 250 kW (340 PS) M5 (E34) 01/92-07/95

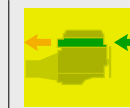

02-36310-01  
11 12 1 401 352



08-27468-03  
11 11 1 315 106



61-36310-00  
11 12 1 401 351  
95,5 Ø  
1,82 mm



15-27162-01



12-26058-01  
11 34 9 059 172



2x 40-76766-20  6x  
13 54 1 317 994



71-27162-10  6x  
11 62 1 312 961



71-27468-10  
11 13 1 722 695



81-17404-00    
48x65  
A OD NBR



81-36496-00    
11 14 1 312 007  
44x62  
SL RD RD FPM



81-20745-40    
11 14 2 245 364  
90x110  
A SL LD FPM



3,9 M67 D39 (398D1) 180 kW (245 PS) 740 d (E38) 05/99-11/01

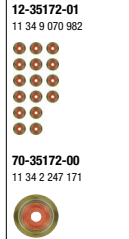
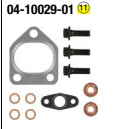



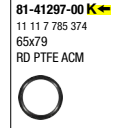
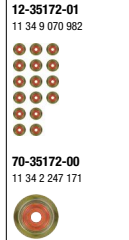











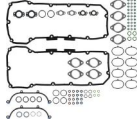







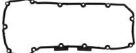

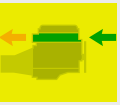

3,9 M67 D39 (398D1) 190 kW (258 PS) 740 d (E65,E66) 10/02-02/05

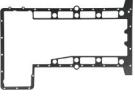

BMW





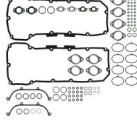















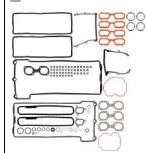
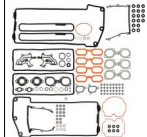
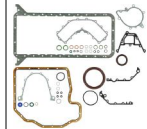



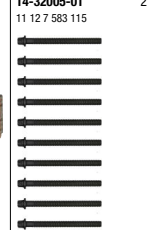
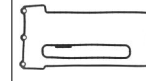

Ltr.	Motor	Power	Models	Year	Image 1	Image 2	Image 3	Image 4	Image 5	Image 6	Image 7	Image 8	Image 9	Image 10	Image 11	Image 12						
4,0	M60 B40 (408S1)	210 kW (286 PS)	540 i (E34) 740 i, iL (E32) 740 i, iL (E38) 840 i (E31)	05/92-07/96																		
						<b>02-31821-01</b> 11 12 1 736 906 	<b>08-31828-01</b> 11 11 9 070 240 		<b>61-31885-00 R</b> 11 12 1 736 317 90 Ø 	<b>14-32005-01</b> 11 12 7 583 115 2x 	<b>15-31821-01 R</b> 11 12 9 069 871 	<b>12-31306-12</b> 11 34 9 063 193 2x 	<b>71-31853-00 L</b> 11 61 1 433 328 4x 	<b>71-31826-00 L</b> 11 61 1 729 727 	<b>71-31827-01 L</b> 11 61 1 729 728 	<b>71-31834-10</b> 11 62 7 505 789 3x 	<b>71-31836-10</b> 11 62 7 509 677 	<b>71-31833-00</b> 18 30 1 728 734 4x 	<b>71-31828-00</b> 11 13 1 725 222 	<b>71-31837-00</b> 11 13 1 436 324 	<b>81-17404-50 K</b> 11 14 1 265 431 48x65 AB SL RD FPM 	<b>81-27373-00 K</b> 11 14 1 713 730 100x125 A SL LD FPM 
4,0	N62 B40 A	220-225 kW (299-306 PS)	540 i (E60) 740 i, iL (E65, E66)	03/05-12/09																		
						<b>02-37331-02</b> 11 12 7 551 822 	<b>08-34067-01</b> 11 11 7 551 866 	<b>15-36164-01</b> 11 141 439 717 	<b>61-35105-00</b> 11 12 7 531 863 0,75 mm MLS 2x 	<b>14-32308-01</b> 11 12 7 583 113 2x 	<b>15-37331-01</b> 11 12 7 513 194 Cyl. 1-4 	<b>12-37281-01</b> 11 34 0 054 492 2x 	<b>71-39409-00 L</b> 11 61 7 537 999 8x 	<b>71-31834-10</b> 11 62 7 505 789 4x 	<b>71-34067-00</b> 11 13 7 506 774 	<b>71-34069-00</b> 11 13 7 545 293 	<b>81-34062-00 K</b> 11 14 7 647 380 45x75 RD FPM 	<b>81-90001-00 K</b> 11 14 7 512 101 100 Ø LD PTFE 				
4,0	N62 B40 A	225 kW (306 PS)	735i (E65, E66)	03/05-12/09																		
						<b>02-37331-02</b> 11 12 7 551 822 	<b>08-34067-01</b> 11 11 7 551 866 		<b>61-35105-00</b> 11 12 7 531 863 0,75 mm MLS 2x 	<b>14-32308-01</b> 11 12 7 583 113 2x 	<b>15-37331-01</b> 11 12 7 513 194 Cyl. 1-4 	<b>12-37281-01</b> 11 34 0 054 492 2x 	<b>71-39409-00 L</b> 11 61 7 537 999 8x 	<b>71-31834-10</b> 11 62 7 505 789 4x 	<b>71-34067-00</b> 11 13 7 506 774 	<b>71-34069-00</b> 11 13 7 545 293 	<b>81-34062-00 K</b> 11 14 7 647 380 45x75 RD FPM 	<b>81-90001-00 K</b> 11 14 7 512 101 100 Ø LD PTFE 				

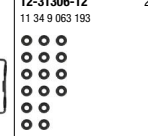
BMW

<p>Ltr.  4,0 S65 B40 A 309 kW (420 PS) M3 (E90) 12/07-10/11 </p>		 <p><b>02-10907-01</b> 11 12 0 429 838</p> 			 <p><b>61-10194-00</b> 2x 11 12 7 841 560 93 Ø 0,6 mm MLS  03/08→</p> 		 <p><b>71-12300-00</b> 11 12 7 838 272 Cyl. 5-8</p>  <p><b>71-12301-00</b> 11 12 7 838 271 Cyl. 1-4</p> 	 <p><b>12-33457-01</b> 2x 11 34 0 032 548</p> 	 <p><b>71-12294-00</b>  4x 11 62 7 841 115 Cyl. 2 Cyl. 3 Cyl. 4 Cyl. 5</p>  <p><b>71-12295-00</b>  4x 11 62 7 838 406 Cyl. 1 Cyl. 6 Cyl. 7 Cyl. 8</p> 	 <p><b>71-12298-00</b> 11 13 7 841 085</p> 	 <p><b>81-38031-00 K</b>  11 21 7 838 072 48x65 LD FPM</p>  <p><b>81-38033-00 K</b>  11 21 7 838 071 100x125 LD FPM</p> 
<p>4,0 S65 B40 A 309 kW (420 PS) M3 (E92) M3 (E93) 06/07-10/13</p>		<p><b>02-10907-01</b> 11 12 0 429 838</p> 									



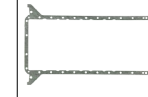
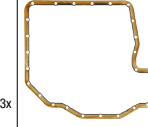

















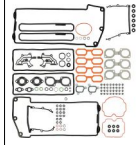

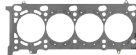

BMW

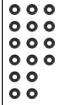
Ltr.  4,4 M62 B44 (448S1) 210 kW (286 PS) 540 i (E39) 740 i, iL (E38) 840 Ci (E31)  02/96-12/03

										
	<p><b>02-31821-02</b> 11 12 1 741 909 1 ⇒ 08/98</p>  <p><b>02-33396-01</b> 11 12 0 004 553 1 ⇒ 09/98 →</p> 	<p><b>08-31828-01</b> 11 11 9 070 240</p> 		<p><b>61-35320-00 R</b> 11 12 1 741 468 93 Ø 1,65 mm 1 ⇒ 09/97</p>  <p><b>61-35325-00 L</b> 11 12 1 741 470 93 Ø 1,65 mm 1 ⇒ 09/97</p>  <p><b>61-31370-00 R</b> 11 12 1 433 473 93 Ø 1,74 mm MLS 1 ⇒ 10/97 →</p> <p><b>61-31370-10 R</b> 11 12 1 433 474 93 Ø 2,07 mm MLS 1 ⇒ 10/97 →</p> <p><b>61-31375-00 L</b> 11 12 1 433 477 93 Ø 1,74 mm MLS 1 ⇒ 10/97 →</p> <p><b>61-31375-10 L</b> 11 12 1 433 478 93 Ø 2,07 mm MLS 1 ⇒ 10/97 →</p> 	<p><b>14-32005-01</b> 11 12 7 583 115</p> 	<p><b>15-31821-01 R</b> 11 12 9 069 871 1 ⇒ 08/98</p>  <p><b>15-31822-01 L</b> 11 12 9 069 872 1 ⇒ 08/98</p>  <p><b>15-33396-01 R</b> 11 12 0 034 104 1 ⇒ 09/98 →</p>  <p><b>15-33397-01 L</b> 11 12 0 034 105 1 ⇒ 09/98 →</p> 	<p><b>12-31306-12</b> 11 34 9 063 193</p>  <p><b>70-31306-00</b> 11 34 2 245 151</p> 	<p><b>71-31853-00 L</b> 4x 11 61 1 433 328</p>  <p><b>71-31826-00 L</b> ① 11 61 1 729 727</p>  <p><b>71-31827-00 L</b> ① 11 61 1 729 728</p>  <p><b>71-31834-10</b> 3x 11 62 7 505 789</p>  <p><b>71-31836-10</b> 11 62 7 509 677</p> 	<p><b>71-31828-00</b> 11 13 1 725 222</p>  <p><b>71-31837-00 ①</b> 11 13 1 436 324</p> 	<p><b>81-17404-50 K</b> 4x 11 14 1 265 431 48x65 AB SL RD FPM</p>  <p><b>81-27373-00 K</b> 4x 11 14 1 713 730 100x125 A SL LD FPM</p> 

BMW





















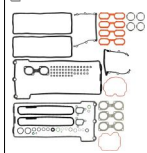
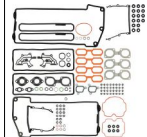
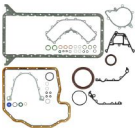
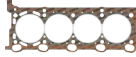

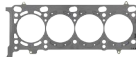

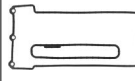

Ltr.  4,4 M62 B44 (448S2) 210 kW (286 PS) X5 4.4 i (E53)  01/00-09/03

										
	<p><b>02-33396-01</b> 11 12 0 004 553</p> 	<p><b>08-31828-01</b> 11 11 9 070 240</p> 		<p><b>61-31370-00 R</b> 11 12 1 433 473 93 Ø 1,74 mm MLS</p> <p><b>61-31370-10 R</b> 11 12 1 433 474 93 Ø 2,07 mm MLS</p>  <p><b>61-31375-00 L</b> 11 12 1 433 477 93 Ø 1,74 mm MLS</p> <p><b>61-31375-10 L</b> 11 12 1 433 478 93 Ø 2,07 mm MLS</p> 	<p><b>14-32005-01</b> 11 12 7 583 115</p> 	<p><b>15-33396-01 R</b> 11 12 0 034 104</p>  <p><b>15-33397-01 L</b> 11 12 0 034 105</p> 	<p><b>12-31306-12</b> 11 34 9 063 193</p>  <p><b>70-31306-00</b> 11 34 2 245 151</p> 	<p><b>71-31853-00 L</b> 11 61 1 433 328</p>  <p><b>71-31834-10</b> 11 62 7 505 789</p>  <p><b>71-31836-10</b> 11 62 7 509 677</p> 	<p><b>71-31828-00</b> 11 13 1 725 222</p>  <p><b>71-31837-00 00</b> 11 13 1 436 324</p> 	<p><b>81-17404-50 K</b> 11 14 1 265 431 48x65 AB SL RD FPM</p>  <p><b>81-27373-00 K</b> 11 14 1 713 730 100x125 A SL LD FPM</p> 





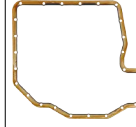

BMW

Ltr.   

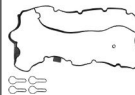
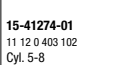
4,4 M62 B44 (448S2) 210 kW (286 PS) 540 i (E39) 740 i L (E38) 02/96-12/03

										
	<p><b>02-31821-02</b> 11 12 1 741 909 1 ⇒ 08/98</p>  <p><b>02-33396-01</b> 11 12 0 004 553 1 ⇒ 09/98 →</p> 	<p><b>08-31828-01</b> 11 11 9 070 240</p> 		<p><b>61-35320-00 R</b> 11 12 1 741 468 93 Ø 1,65 mm 1 ⇒ 09/97</p>  <p><b>61-35325-00 L</b> 11 12 1 741 470 93 Ø 1,65 mm 1 ⇒ 09/97</p>  <p><b>61-31370-00 R</b> 11 12 1 433 473 93 Ø 1,74 mm MLS 1 ⇒ 10/97 →</p> <p><b>61-31370-10 R</b> 11 12 1 433 474 93 Ø 2,07 mm MLS 1 ⇒ 10/97 →</p>  <p><b>61-31375-00 L</b> 11 12 1 433 477 93 Ø 1,74 mm MLS 1 ⇒ 10/97 →</p> <p><b>61-31375-10 L</b> 11 12 1 433 478 93 Ø 2,07 mm MLS 1 ⇒ 10/97 →</p> 	<p><b>14-32005-01</b> 11 12 7 583 115</p> 	<p><b>15-31821-01 R</b> 11 12 9 069 871 1 ⇒ 08/98</p>  <p><b>15-31822-01 L</b> 11 12 9 069 872 1 ⇒ 08/98</p>  <p><b>15-33396-01 R</b> 11 12 0 034 104 1 ⇒ 09/98 →</p>  <p><b>15-33397-01 L</b> 11 12 0 034 105 1 ⇒ 09/98 →</p> 	<p><b>12-31306-12</b> 11 34 9 063 193</p>  <p><b>70-31306-00</b> 11 34 2 245 151</p> 	<p><b>71-31853-00 L</b> 4x 11 61 1 433 328</p>  <p><b>71-31834-10</b> 3x 11 62 7 505 789</p>  <p><b>71-31836-10</b> 32x 11 62 7 509 677</p> 	<p><b>71-31828-00</b> 11 13 1 725 222</p>  <p><b>71-31837-00</b> 11 13 1 436 324</p> 	<p><b>81-17404-50 K</b> 11 14 1 265 431 48x65 AB SL RD FPM</p>  <p><b>81-27373-00 K</b> 11 14 1 713 730 100x125 A SL LD FPM</p> 

4,4 M67 D44 (448D1) 242 kW (329 PS) 745 d (E65,E66) 07/05-07/08



















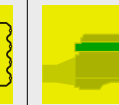
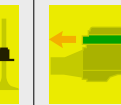
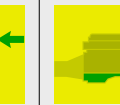





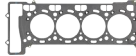
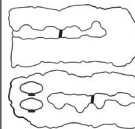

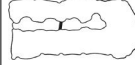



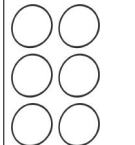

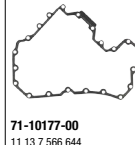









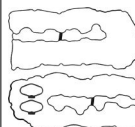

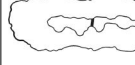
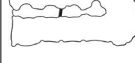



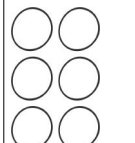

						<p><b>15-41273-01</b> 11 12 0 403 101 Cyl. 1-4</p>  <p><b>15-41274-01</b> 11 12 0 403 102 Cyl. 5-8</p> 	<p><b>12-37281-01</b> 11 34 0 054 492</p> 	<p><b>11-41319-01</b> 2x 11 61 7 792 507</p>  <p><b>71-41324-00</b> 2x 11 62 7 798 545</p> 	<p><b>71-41292-00</b> 11 13 7 798 479</p> 	<p><b>81-41297-00 K</b> 11 11 7 785 374 65x79 RD PTFE ACM</p> 
--	--	--	--	--	--	---	---	---	---	---

BMW

Ltr.																
4,4	N62 B44 A	235 kW (320 PS)	X5 4.4 i (E53)	10/03-10/06		<b>02-37331-01</b> 11 12 7 518 017 	<b>08-34069-01</b> 11 11 0 304 864 	<b>15-36164-01</b> 11 14 1 439 717 	<b>61-33705-00</b> 2x 11 12 7 513 944 93 Ø 0,75 mm MLS  <b>61-33705-10</b> 2x 11 12 7 513 945 93 Ø 1,05 mm MLS 	<b>14-32308-01</b> 2x 11 12 7 583 113 	<b>15-37331-01</b> 11 12 7 513 194 Cyl. 1-4 	<b>12-37281-01</b> 2x 11 34 0 054 492 	<b>71-39428-00</b> 11 61 7 521 181   <b>71-31834-10</b> 4x 11 62 7 505 789 	<b>71-34069-00</b> 11 13 7 545 293 	<b>81-39391-00</b> 11 14 7 647 381 45x75 A SL2 RD PTFE (Polytetrafluorethylen)/FPM (Fluor-Kautschuk)   <b>81-90001-00</b> 11 14 7 512 101 100 Ø LD PTFE 	
4,4	N62 B44 A	245 kW (333 PS)	545 i (E60) 545 i (E61) 645 Ci (E63) 645 Ci (E64)	07/03-12/10		<b>02-37331-01</b> 11 12 7 518 017 	<b>08-34067-01</b> 11 11 7 551 866 	<b>15-36164-01</b> 11 14 1 439 717 	<b>61-33705-00</b> 2x 11 12 7 513 944 93 Ø 0,75 mm MLS  <b>61-33705-10</b> 2x 11 12 7 513 945 93 Ø 1,05 mm MLS 	<b>14-32308-01</b> 2x 11 12 7 583 113 	<b>15-37331-01</b> 11 12 7 513 194 Cyl. 1-4 	<b>12-37281-01</b> 2x 11 34 0 054 492 	<b>71-39428-00</b> 11 61 7 521 181   <b>71-31834-10</b> 4x 11 62 7 505 789 	<b>71-34067-00</b> 11 13 7 506 774 	<b>81-34062-00</b> 11 14 7 647 380 45x75 RD FPM   <b>81-90001-00</b> 11 14 7 512 101 100 Ø LD PTFE 	
4,4	N62 B44 A	245 kW (333 PS)	745 Li (E65,E66)	07/01-03/05		<b>02-37331-01</b> 1x 11 12 7 518 017 	<b>08-34067-01</b> 11 11 7 551 866 	<b>15-36164-01</b> 11 14 1 439 717 	<b>61-33705-00</b> 2x 11 12 7 513 944 93 Ø 0,75 mm MLS  <b>61-33705-10</b> 2x 11 12 7 513 945 93 Ø 1,05 mm MLS 	<b>14-32308-01</b> 2x 11 12 7 583 113 	<b>15-37331-01</b> 11 12 7 513 194 Cyl. 1-4 	<b>12-37281-01</b> 2x 11 34 0 054 492 	<b>71-39428-00</b> 11 61 7 521 181   <b>71-37337-00</b> 4x 11 62 7 505 788  10/03  <b>71-31834-10</b> 4x 11 62 7 505 789  11/03→  <b>71-31834-10</b> 4x 11 62 7 505 789 	<b>71-34069-00</b> 11 13 7 545 293 	<b>81-34062-00</b> 11 14 7 647 380 45x75 RD FPM   <b>81-90001-00</b> 11 14 7 512 101 100 Ø LD PTFE 	

















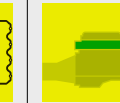
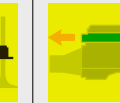
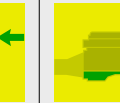
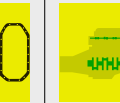

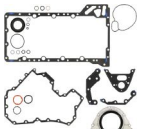
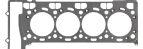

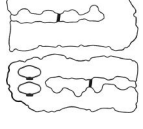

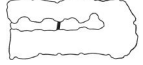

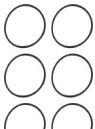
BMW











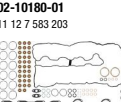
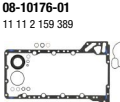

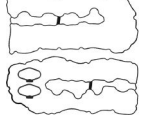
<p>Ltr.  N63 B44 A</p> <p>298 kW (405 PS)</p> <p>650 i (F12) 650 i (F13)</p> <p>09/11-12/12</p> <p>          </p>	<p><b>02-10180-01</b> 11 12 7 583 203</p> 	<p><b>08-10176-01</b> 11 11 2 159 389</p> 		<p><b>61-36445-00</b>  2x 11 12 7 567 765 0,75 mm MLS</p> <p><b>61-36445-10</b>  2x 11 12 7 567 764 1,05 mm MLS</p> 			<p><b>15-10180-01</b></p>  <p><b>71-10170-00</b> 2x 11 12 8 636 401</p>  <p><b>71-10179-00</b> 11 12 7 566 289 Cyl. 5-8</p>  <p><b>71-10180-00</b> 11 12 7 566 288 Cyl. 1-4</p> 	<p><b>12-37281-01</b> 2x 11 34 0 054 492</p>  <p><b>70-37281-00</b> 32x 11 34 7 505 417</p> 	<p><b>11-37133-01</b>  2x 11 61 7 547 242</p>  <p><b>71-10167-00</b>  2x 11 62 7 576 990</p> 	<p><b>71-10176-00</b> 11 13 7 570 705</p>  <p><b>71-10177-00</b> 11 13 7 566 644</p> 	<p><b>81-34062-00</b>  K</p> <p>11 14 7 647 380 45x75 RD FPM</p>  <p><b>81-10403-00</b>  K</p> <p>11 14 8 483 798 PTFE</p> 
<p>4,4 N63 B44 A</p> <p>298-330 kW (405-449 PS)</p> <p>X5 5.0 i (E70) X6 5.0 i (E71, E72) 550 i (F07) 550 i (F10) 550 i (F11) 650 i xDrive (F12) 750 i (F01, F02)</p> <p>10/07-06/14</p>	<p><b>02-10180-01</b> 11 12 7 583 203</p> 	<p><b>08-10176-01</b> 11 11 2 159 389</p> 		<p><b>61-36445-00</b>  2x 11 12 7 567 765 0,75 mm MLS</p> <p><b>61-36445-10</b>  2x 11 12 7 567 764 1,05 mm MLS</p> 			<p><b>15-10180-01</b></p>  <p><b>71-10170-00</b> 2x 11 12 8 636 401</p>  <p><b>71-10179-00</b> 11 12 7 566 289 Cyl. 5-8</p>  <p><b>71-10180-00</b> 11 12 7 566 288 Cyl. 1-4</p> 	<p><b>12-37281-01</b> 2x 11 34 0 054 492</p>  <p><b>70-37281-00</b> 32x 11 34 7 505 417</p> 	<p><b>11-37133-01</b>  2x 11 61 7 547 242</p>  <p><b>71-10167-00</b>  2x 11 62 7 576 990</p>  <p><b>71-11399-00</b>    18 30 7 553 601</p> 	<p><b>71-10176-00</b> 11 13 7 570 705</p>  <p><b>71-10177-00</b> 11 13 7 566 644</p> 	<p><b>81-34062-00</b>  K</p> <p>11 14 7 647 380 45x75 RD FPM</p>  <p><b>81-10403-00</b>  K</p> <p>11 14 8 483 798 PTFE</p> 

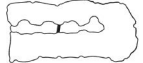
BMW

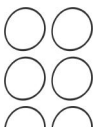
Ltr.  N63 B44 A 300 kW (408 PS) 750 i (F01, F02) 09/08-06/12 

										
	<p><b>02-10180-01</b> 11 12 7 583 203</p> 	<p><b>08-10176-01</b> 11 11 2 159 389</p> 		<p><b>61-36445-00</b> 2x 11 12 7 567 765 0,75 mm MLS</p> <p><b>61-36445-00</b> 2x 11 12 7 567 765 0,75 mm MLS</p> <p><b>61-36445-10</b> 2x 11 12 7 567 764 1,05 mm MLS</p> 	<p><b>14-17059-01</b> 2x</p> 	<p><b>15-10180-01</b></p>  <p><b>71-10170-00</b> 2x 11 12 8 636 401</p>  <p><b>71-10179-00</b> 11 12 7 566 289 Cyl. 5-8</p>  <p><b>71-10180-00</b> 11 12 7 566 288 Cyl. 1-4</p> 	<p><b>12-37281-01</b> 2x 11 34 0 054 492</p>  <p><b>70-37281-00</b> 32x 11 34 7 505 417</p> 	<p><b>11-37133-01</b> 2x 11 61 7 547 242</p>  <p><b>71-10167-00</b> 2x 11 62 7 576 990</p>  <p><b>71-11399-00</b> 18 18 30 7 553 601</p> 	<p><b>71-10176-00</b> 2x 11 13 7 570 705</p>  <p><b>71-10177-00</b> 11 13 7 566 644</p> 	<p><b>81-34062-00 K</b> 11 14 7 647 380 45x75 RD FPM</p>  <p><b>81-39391-00 K</b> 11 14 7 647 381 45x75 A SL2 RD PTFE (Polytetrafluorethylen)/FPM (Fluor-Kautschuk)</p>  <p><b>81-10403-00 K</b> 11 14 8 483 798 PTFE</p> 

4,4 N63 B44 A 300-357 kW (407-485 PS) X6 (E71, E72) Hybrid X6 07/08-02/15  
X6 5.0 i (E71)  
550 i (F07)  
550 i (F10)  
650 i (F12)  
650 i (F13)

				<p><b>61-36445-00</b> 2x 11 12 7 567 765 0,75 mm MLS</p> <p><b>61-36445-10</b> 2x 11 12 7 567 764 1,05 mm MLS</p> 	<p><b>14-17059-01</b> 2x</p> 	<p><b>15-10180-01</b></p>  <p><b>71-10170-00</b> 2x 11 12 8 636 401</p>  <p><b>71-10179-00</b> 11 12 7 566 289 Cyl. 5-8</p>  <p><b>71-10180-00</b> 11 12 7 566 288 Cyl. 1-4</p> 	<p><b>12-37281-01</b> 2x 11 34 0 054 492</p>  <p><b>70-37281-00</b> 32x 11 34 7 505 417</p> 	<p><b>11-37133-01</b> 2x 11 61 7 547 242</p>  <p><b>71-10167-00</b> 2x 11 62 7 576 990</p>  <p><b>71-11399-00</b> 18 18 30 7 553 601</p> 	<p><b>71-10176-00</b> 2x 11 13 7 570 705</p>  <p><b>71-10177-00</b> 11 13 7 566 644</p> 	<p><b>81-34062-00 K</b> 11 14 7 647 380 45x75 RD FPM</p>  <p><b>81-10403-00 K</b> 11 14 8 483 798 PTFE</p> 
---	---	--	--	---	--	--	--	--	--	--





BMW

















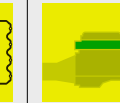
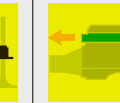
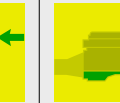
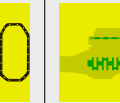

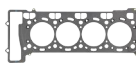
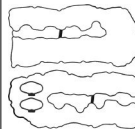

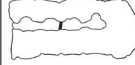

Ltr.	Motor	Power (kW/PS)	Model	Year	Image 1	Image 2	Image 3	Image 4	Image 5	Image 6	Image 7	Image 8	Image 9	Image 10	Image 11	Image 12			
4,4	N63 B44 B	298 kW (405 PS)	750 Li (F01, F02, F03, F04)	09/08-08/15															
						<b>02-10180-01</b> 11 12 7 583 203 	<b>08-10176-01</b> 11 11 2 159 389 	<b>15-10171-01</b> 11 14 7 566 411 	<b>61-36445-00</b> 2x 11 12 7 567 765 0,75 mm MLS <b>61-36445-10</b> 2x 11 12 7 567 764 1,05 mm MLS 	<b>14-17059-01</b> 2x 11 12 7 582 454 	<b>15-10180-01</b> 	<b>12-37281-01</b> 2x 11 34 0 054 492 	<b>71-10167-00</b> 2x 11 62 7 576 990 	<b>71-10176-00</b> 11 13 7 570 705 	<b>81-34062-00</b> 11 14 7 647 380 45x75 RD FPM 	<b>71-11399-00</b> 2x 18 30 7 553 601 	<b>70-37281-00</b> 32x 11 34 7 505 417 	<b>71-10177-00</b> 11 13 7 566 644 	<b>81-10403-00</b> 11 14 8 483 798 PTFE 
4,4	N63 B44 B	330 kW (449 PS)	X5 xDrive 50 i (F15) 650 i (F12)	07/12-07/18															
4,4	N63 B44 B	330 kW (449 PS)	X6 xDrive 50 i (F16, F86)	08/14-07/19															
							<b>08-10176-01</b> 11 11 2 159 389 		<b>61-36445-00</b> 2x 11 12 7 567 765 0,75 mm MLS <b>61-36445-10</b> 2x 11 12 7 567 764 1,05 mm MLS 	<b>14-17059-01</b> 2x 11 12 7 582 454 	<b>15-10493-01</b> 2x 11 12 7 614 700 Cyl. 1-4 	<b>15-10931-01</b> 11 12 7 614 701 Cyl. 5-8 	<b>12-37281-01</b> 2x 11 34 0 054 492 	<b>71-16791-00</b> 8x 11 61 7 637 306 	<b>71-10177-00</b> 11 13 7 566 644 	<b>81-10403-00</b> 11 14 8 483 798 PTFE 	<b>71-10167-00</b> 2x 11 62 7 576 990 	<b>71-10305-00</b> 11 13 7 566 808 	<b>71-11399-00</b> 2x 18 30 7 553 601 

BMW



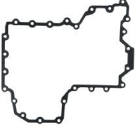







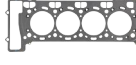

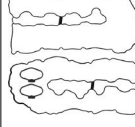

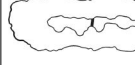
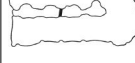

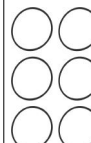

Ltr.															
4,4	N63 B44 B	330 kW (449 PS)	07/12-10/18	550 i (F07) 550 i (F10) 550 i (F11) 550 i xDrive (F10) 650 i (F06) 650 i (F13) 650 i xDrive (F06) 750 i (F01, F02, F03, F04) 750 i xDrive (F01, F02, F03, F04)			 <b>08-10176-01</b> 11 11 2 159 389	 <b>15-10171-01</b> 11 14 7 566 411	 <b>61-36445-00</b> 11 12 7 567 765 0,75 mm MLS <b>61-36445-10</b> 11 12 7 567 764 1,05 mm MLS	 <b>14-17059-01</b> 11 12 7 582 454	 <b>15-10493-01</b> 11 12 7 614 700 Cyl. 1-4 <b>15-10931-01</b> 11 12 7 614 701 Cyl. 5-8	 <b>12-37281-01</b> 11 34 0 054 492 <b>70-37281-00</b> 11 34 7 505 417	 <b>71-10167-00</b> 11 62 7 576 990 <b>71-11399-00</b> 18 30 7 553 601	 <b>71-10176-00</b> 11 13 7 570 705 <b>71-10177-00</b> 11 13 7 566 644	 <b>81-34062-00 K</b> 11 14 7 647 380 45x75 RD FPM <b>81-10403-00 K</b> 11 14 8 483 798 PTFE
4,4	N63 B44 B	331 kW (450 PS)	09/12-06/15	750 i (F01, F02, F03, F04)			 <b>08-10176-01</b> 11 11 2 159 389	 <b>15-10171-01</b> 11 14 7 566 411	 <b>61-36445-00</b> 11 12 7 567 765 0,75 mm MLS <b>61-36445-10</b> 11 12 7 567 764 1,05 mm MLS	 <b>14-17059-01</b> 11 12 7 582 454		 <b>12-37281-01</b> 11 34 0 054 492 <b>70-37281-00</b> 11 34 7 505 417	 <b>71-10167-00</b> 11 62 7 576 990	 <b>71-10176-00</b> 11 13 7 570 705 <b>71-10177-00</b> 11 13 7 566 644	 <b>81-34062-00 K</b> 11 14 7 647 380 45x75 RD FPM <b>81-10403-00 K</b> 11 14 8 483 798 PTFE
4,4	N63 B44 C	330-340 kW (449-462 PS)	09/15-06/19	M550 i xDrive (G30) 750 i (G11, G12) 750 i, Li xDrive (G11, G12)			 <b>61-10021-00</b> 11 12 8 647 839 90 Ø 0,77 mm MLS <b>61-10021-10</b> 11 12 8 647 840 90 Ø 1,07 mm MLS		 <b>14-17059-01</b> 11 12 7 582 454	 <b>15-10055-01</b> 11 12 8 636 546 Cyl. 1-4 <b>15-10056-01</b> 11 12 8 636 547 Cyl. 5-8	 <b>12-37281-01</b> 11 34 0 054 492	 <b>71-17369-00</b> 11 61 8 610 666 <b>71-10167-00</b> 11 62 7 576 990 <b>71-11399-00</b> 18 30 7 553 601	 <b>71-13159-00</b> 11 13 8 601 057 <b>71-13160-00</b> 11 13 8 601 061	 <b>81-34062-00 K</b> 11 14 7 647 380 45x75 RD FPM <b>81-10403-00 K</b> 11 14 8 483 798 PTFE	
4,4	N63 B44 D	340-390 kW (462-530 PS)	08/18	M 850 i xDrive (G15, F92) X5 xDrive 50 i (G05, F95) X7 xDrive 50 i (G07) 750 i, Li xDrive (G11, G12)					 <b>14-17059-01</b> 11 12 7 582 454	 <b>15-10055-01</b> 11 12 8 636 546 Cyl. 1-4 <b>15-10056-01</b> 11 12 8 636 547 Cyl. 5-8	 <b>12-37281-01</b> 11 34 0 054 492 <b>70-37281-00</b> 11 34 7 505 417	 <b>71-17369-00</b> 11 61 8 610 666	 <b>71-13159-00</b> 11 13 8 601 057	 <b>81-39391-00 K</b> 11 14 7 647 381 45x75 A SL2 RD PTFE (Polytetrafluorethylen)/FPM (Fluor-Kautschuk) <b>81-10403-00 K</b> 11 14 8 483 798 PTFE	





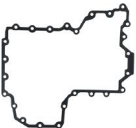











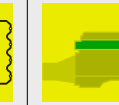
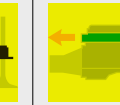
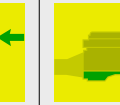

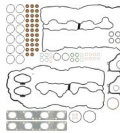
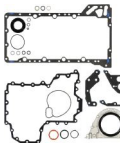
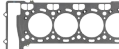
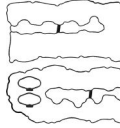

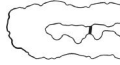
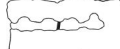





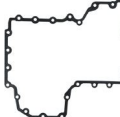

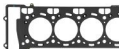



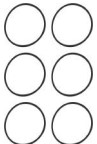







BMW

Ltr.  4,4 S63 B44 A 408 kW (555 PS) X5 M 4.4 i (E70) 07/09-07/13  1

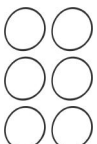
										
	<p><b>02-36445-01</b> 11 12 2 159 374</p> 			<p><b>61-36445-00</b> 2x 11 12 7 567 765 0,75 mm MLS</p> <p><b>61-36445-10</b> 2x 11 12 7 567 764 1,05 mm MLS</p> 		<p><b>15-10180-01</b></p>  <p><b>71-10170-00</b> 2x 11 12 8 636 401</p>  <p><b>71-10179-00</b> 11 12 7 566 289 Cyl. 5-8</p>  <p><b>71-10180-00</b> 11 12 7 566 288 Cyl. 1-4</p> 	<p><b>12-37281-01</b> 2x 11 34 0 054 492</p>  <p><b>70-37281-00</b> 32x 11 34 7 505 417</p> 	<p><b>11-37133-01</b> 2x 11 61 7 547 242</p>  <p><b>71-10304-00</b> 2x 11 62 7 589 106</p>  <p><b>71-11399-00</b>   18 30 7 553 601</p> 	<p><b>71-10177-00</b> 11 13 7 566 644</p>  <p><b>71-10305-00</b> 11 13 7 566 808</p> 	<p><b>81-39391-00</b>  11 14 7 647 381 45x75 A SL2 RD PTFE (Polytetrafluorethylen)/FPM (Fluor-Kautschuk)</p>  <p><b>81-10403-00</b>  11 14 8 483 798 PTFE</p> 

















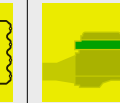
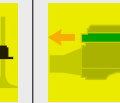
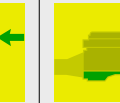
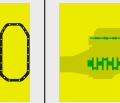

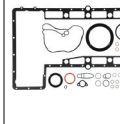
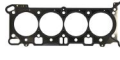
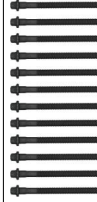
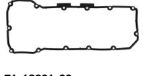
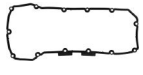
4,4 S63 B44 A 408 kW (555 PS) X6 (E71) 07/09-07/14

	<p><b>02-36445-01</b> 11 12 2 159 374</p> 		<p><b>61-36445-00</b> 2x 11 12 7 567 765 0,75 mm MLS</p> <p><b>61-36445-10</b> 2x 11 12 7 567 764 1,05 mm MLS</p> 	<p><b>14-17059-01</b> 2x 11 12 7 582 454</p> 	<p><b>15-10180-01</b></p>  <p><b>71-10170-00</b> 2x 11 12 8 636 401</p>  <p><b>71-10179-00</b> 11 12 7 566 289 Cyl. 5-8</p>  <p><b>71-10180-00</b> 11 12 7 566 288 Cyl. 1-4</p> 	<p><b>12-37281-01</b> 2x 11 34 0 054 492</p>  <p><b>70-37281-00</b> 32x 11 34 7 505 417</p> 	<p><b>11-37133-01</b>  11 61 7 547 242</p>  <p><b>71-10304-00</b> 2x 11 62 7 589 106</p>  <p><b>71-11399-00</b>   18 30 7 553 601</p> 	<p><b>71-10177-00</b> 11 13 7 566 644</p>  <p><b>71-10305-00</b> 11 13 7 566 808</p> 	<p><b>81-39391-00</b>  11 14 7 647 381 45x75 A SL2 RD PTFE (Polytetrafluorethylen)/FPM (Fluor-Kautschuk)</p>  <p><b>81-10403-00</b>  11 14 8 483 798 PTFE</p> 
--	---	--	---	--	--	--	--	--	---



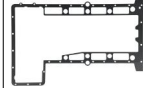









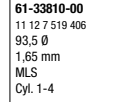
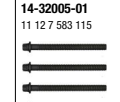
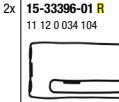
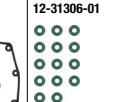
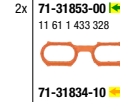
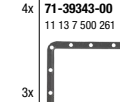

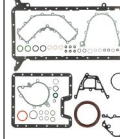

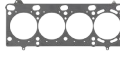
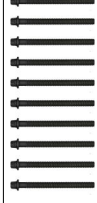





BMW															
4,4	S63 B44 A	414 kW (563 PS)	X5 M (E70) X6 M (E71, E72)	07/08-06/14		<b>02-36445-01</b> 11 12 2 159 374 	<b>08-10176-02</b> 11 11 2 158 085 	<b>61-36445-00</b> 2x 11 12 7 567 765 0,75 mm MLS <b>61-36445-10</b> 2x 11 12 7 567 764 1,05 mm MLS 		<b>15-10180-01</b>  <b>71-10170-00</b> 2x 11 12 8 636 401  <b>71-10179-00</b> 11 12 7 566 289 Cyl. 5-8  <b>71-10180-00</b> 11 12 7 566 288 Cyl. 1-4 	<b>12-37281-01</b> 2x 11 34 0 054 492  <b>70-37281-00</b> 32x 11 34 7 505 417 	<b>11-37133-01</b> 2x 11 61 7 547 242  <b>71-10304-00</b> 2x 11 62 7 589 106  <b>71-11399-00</b> 10 18 30 7 553 601 	<b>71-10177-00</b> 11 13 7 566 644  <b>71-10305-00</b> 11 13 7 566 808 	<b>81-39391-00</b> K↔ 11 14 7 647 381 45x75 A SL2 RD PTFE (Polytetrafluorethylen)/FPM (Fluor-Kautschuk)  <b>81-10403-00</b> K↔ 11 14 8 483 798 PTFE 	
4,4	S63 B44 B	412-441 kW (560-600 PS)	M5 (F10) M5 (F10, F18) M5 (F32, F82) M6 (F06) M6 (F12) M6 (F13)	09/11-10/18				<b>61-10127-00</b> 2x 11 12 8 008 122 89 Ø 0,75 mm MLS <b>61-10127-10</b> 2x 11 12 8 008 118 89 Ø 1,05 mm MLS 	<b>14-17059-01</b> 2x 11 12 7 582 454 	<b>15-10493-01</b> 11 12 7 614 700 Cyl. 1-4  <b>15-10931-01</b> 11 12 7 614 701 Cyl. 5-8 	<b>12-37281-01</b> 2x 11 34 0 054 492 	<b>11-37133-01</b> 2x 11 61 7 547 242  <b>71-10304-00</b> 2x 11 62 7 589 106  <b>71-11399-00</b> 10 18 30 7 553 601 	<b>71-17431-00</b> 11 13 7 843 145  <b>71-17435-00</b> 11 13 7 843 149 	<b>81-34062-00</b> K↔ 11 14 7 647 380 45x75 RD FPM  <b>81-10570-00</b> K↔ 11 42 8 092 562 100x120 PTFE 	
4,4	S63 B44 B	423 kW (575 PS)	X5 M (F15, F85) X6 M (F16, F86)	12/14-07/19				<b>61-36445-00</b> 2x 11 12 7 567 765 0,75 mm MLS <b>61-36445-10</b> 2x 11 12 7 567 764 1,05 mm MLS 	<b>14-17059-01</b> 2x 11 12 7 582 454 	<b>15-10493-01</b> 11 12 7 614 700 Cyl. 1-4  <b>15-10931-01</b> 11 12 7 614 701 Cyl. 5-8 	<b>12-37281-01</b> 2x 11 34 0 054 492 	<b>11-37133-01</b> 2x 11 61 7 547 242  <b>71-10304-00</b> 2x 11 62 7 589 106  <b>71-11399-00</b> 10 18 30 7 553 601 	<b>71-17431-00</b> 11 13 7 843 145  <b>71-17435-00</b> 11 13 7 843 149 	<b>81-34062-00</b> K↔ 11 14 7 647 380 45x75 RD FPM  <b>81-10570-00</b> K↔ 11 42 8 092 562 100x120 PTFE 	

BMW

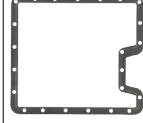









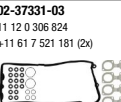
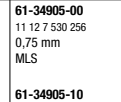
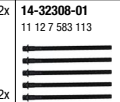
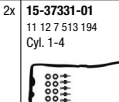
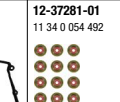
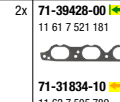
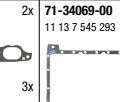

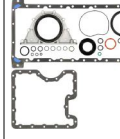

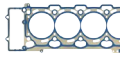

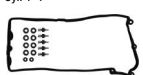
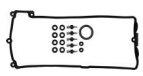



Ltr.  S65 B44 A 331 kW (450 PS) M GTS (E92) M3 CRT (E90) 03/07-06/13 

										
	<b>02-10907-01</b> 11 12 0 429 838 	<b>08-12298-01</b> 11 11 0 429 839 		<b>61-10194-00</b> 2x 11 12 7 841 560 93 Ø 0,6 mm MLS 	<b>14-12256-01</b> 2x 11 12 7 838 831 	<b>71-12300-00</b> 11 62 7 838 272 Cyl. 5-8  <b>71-12301-00</b> 11 12 7 838 271 Cyl. 1-4 	<b>12-33457-01</b> 2x 11 34 0 032 548 	<b>71-12294-00</b>  4x 11 62 7 841 115 Cyl. 2 Cyl. 3 Cyl. 4 Cyl. 5  <b>71-12295-00</b>  4x 11 62 7 838 406 Cyl. 1 Cyl. 6 Cyl. 7 Cyl. 8 	<b>71-12298-00</b> 11 13 7 841 085 	<b>81-38031-00 K</b>  11 21 7 838 072 48x65 LD FPM  <b>81-38033-00 K</b>  11 21 7 838 071 100x125 LD FPM 

4,6 M62 B46 (468S1) 255 kW (347 PS) X5 (E53) 10/01-09/03

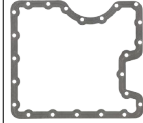

										
	<b>02-33396-01</b> 11 12 0 004 553 	<b>08-39344-01</b> 11 11 0 008 361 		<b>61-33810-00</b> 11 12 7 519 406 93,5 Ø 1,65 mm MLS Cyl. 1-4  <b>61-33810-10</b> 11 12 7 519 405 93,5 Ø 1,95 mm MLS Cyl. 1-4 	<b>14-32005-01</b> 2x 11 12 7 583 115 	<b>15-33396-01 R</b> 11 12 0 034 104  <b>15-33397-01 L</b> 11 12 0 034 105 	<b>12-31306-01</b> 2x 11 34 2 245 151 	<b>71-31853-00 L</b>  4x 11 61 1 433 328  <b>71-31834-10</b>  3x 11 62 7 505 789  <b>71-31836-10</b>  32x 11 62 7 509 677 	<b>71-39343-00</b> 11 13 7 500 261  <b>71-39344-00</b> 11 13 7 500 260 	<b>81-17404-50 K</b>  11 14 1 265 431 48x65 AB SL RD FPM  <b>81-27373-00 K</b>  11 14 1 719 730 100x125 A.S.L LD FPM 

4,8 N62 B48 A 265 kW (360 PS) X5 4.8 is (E53) 04/04-09/06

										
	<b>02-37331-03</b> 11 12 0 308 824 +11 61 7 521 181 (2x) 	<b>08-34069-01</b> 11 11 0 304 864 		<b>61-34905-00</b> 2x 11 12 7 530 256 0,75 mm MLS  <b>61-34905-10</b> 2x 11 12 7 530 257 1,05 mm MLS 	<b>14-32308-01</b> 2x 11 12 7 583 113 	<b>15-37331-01</b> 11 12 7 513 194 Cyl. 1-4  <b>15-37332-01</b> 11 12 7 513 195 Cyl. 5-8 	<b>12-37281-01</b> 2x 11 34 0 054 492  <b>70-37281-00</b> 32x 11 34 7 505 417 	<b>71-39428-00</b>  2x 11 61 7 521 181  <b>71-31834-10</b>  3x 11 62 7 505 789  <b>71-31836-10</b>  32x 11 62 7 509 677 	<b>71-34069-00</b> 11 13 7 545 293  <b>71-39381-00</b> 11 13 7 539 582 	<b>81-39391-00 K</b>  11 14 7 647 381 45x75 A.S.L2 RD PTFE (Polytetrafluorethylen)/FPM (Fluor-Kautschuk)  <b>81-90001-00 K</b>  11 14 7 512 101 100 Ø LD PTFE 



BMW

Ltr.   

4,8 N62 B48 A 270 kW (367 PS) 550 i (E61) 07/05-12/10

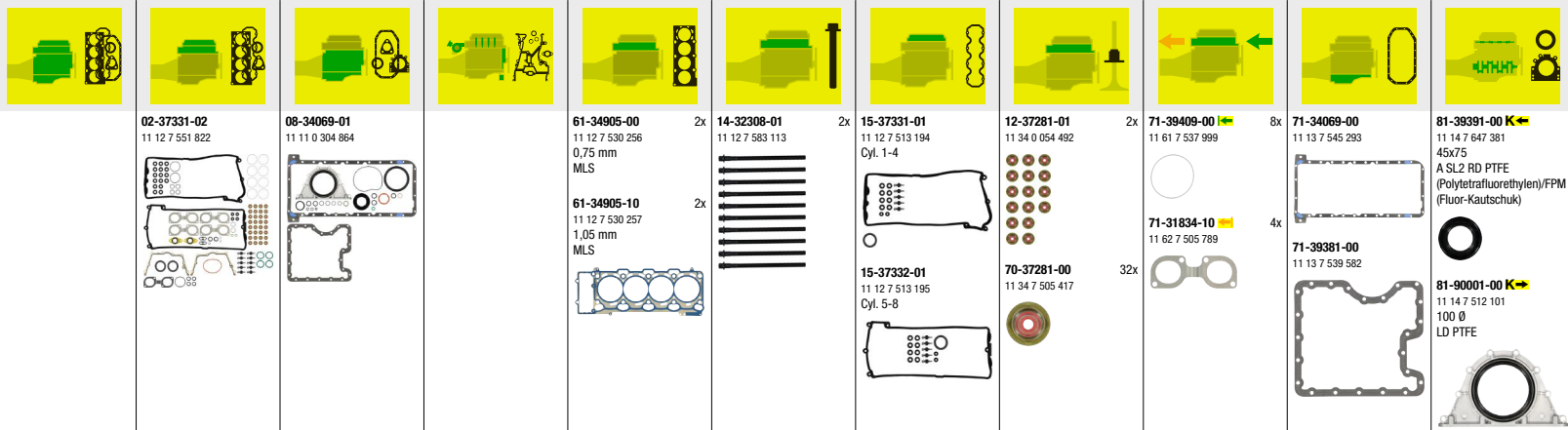

**02-37331-02**  
11 12 7 551 822

**08-34069-01**  
11 11 0 304 864

**61-34905-00** 2x  
11 12 7 530 256  
0,75 mm  
MLS

**61-34905-10** 2x  
11 12 7 530 257  
1,05 mm  
MLS

**14-32308-01** 2x  
11 12 7 583 113

**15-37331-01**  
11 12 7 513 194  
Cyl. 1-4

**15-37332-01**  
11 12 7 513 195  
Cyl. 5-8

**12-37281-01** 2x  
11 34 0 054 492

**71-39409-00**  8x  
11 61 7 537 999

**71-31834-10**  4x  
11 62 7 505 789

**71-34069-00**  
11 13 7 545 293

**71-39381-00**  
11 13 7 539 582

**81-39391-00**   
11 14 7 647 381  
45x75  
A SL2 RD PTFE  
(Polytetrafluorethylen)/FPM  
(Fluor-Kautschuk)

**81-90001-00**   
11 14 7 512 101  
100 Ø  
LD PTFE

4,8 N62 B48 B 261 kW (355 PS) X5 4.8 i (E70) 10/06-03/10

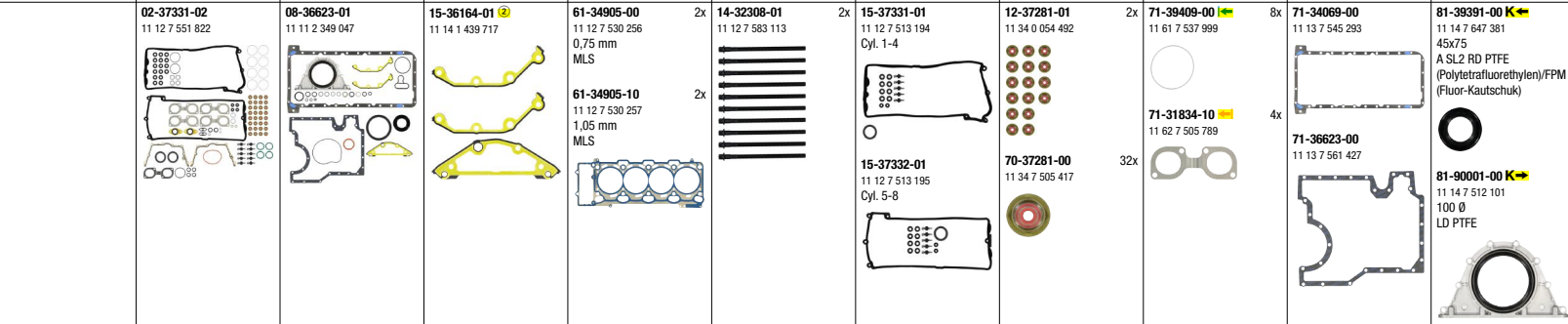

**02-37331-02**  
11 12 7 551 822

**08-36623-01**  
11 11 2 349 047

**15-36164-01**   
11 14 1 439 717

**61-34905-00** 2x  
11 12 7 530 256  
0,75 mm  
MLS

**61-34905-10** 2x  
11 12 7 530 257  
1,05 mm  
MLS

**14-32308-01** 2x  
11 12 7 583 113

**15-37331-01**  
11 12 7 513 194  
Cyl. 1-4

**15-37332-01**  
11 12 7 513 195  
Cyl. 5-8

**12-37281-01** 2x  
11 34 0 054 492

**71-39409-00**  8x  
11 61 7 537 999

**71-31834-10**  4x  
11 62 7 505 789

**71-34069-00**  
11 13 7 545 293

**71-36623-00**  
11 13 7 561 427

**81-39391-00**   
11 14 7 647 381  
45x75  
A SL2 RD PTFE  
(Polytetrafluorethylen)/FPM  
(Fluor-Kautschuk)

**81-90001-00**   
11 14 7 512 101  
100 Ø  
LD PTFE

4,8 N62 B48 B 270 kW (367 PS) 550 i (E60) 550 i (E61) 650 i (E63) 07/05-12/10

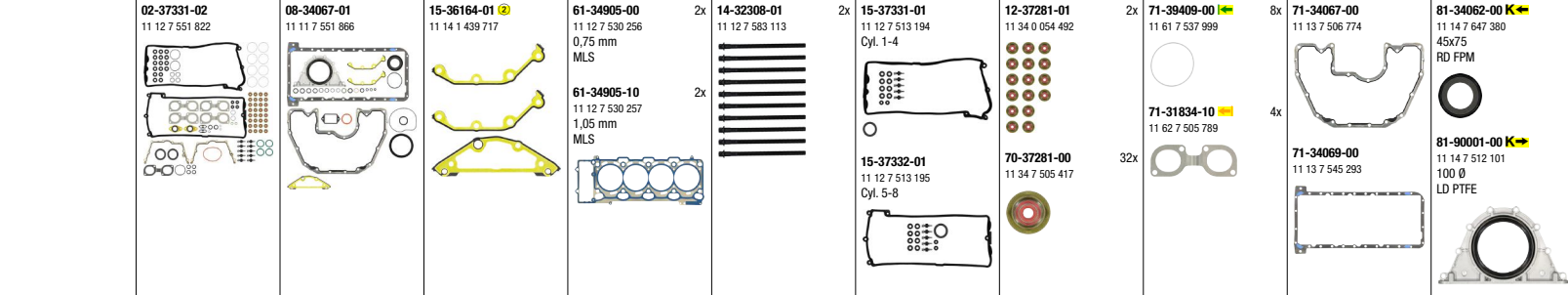

**02-37331-02**  
11 12 7 551 822

**08-34067-01**  
11 11 7 551 866

**15-36164-01**   
11 14 1 439 717

**61-34905-00** 2x  
11 12 7 530 256  
0,75 mm  
MLS

**61-34905-10** 2x  
11 12 7 530 257  
1,05 mm  
MLS

**14-32308-01** 2x  
11 12 7 583 113

**15-37331-01**  
11 12 7 513 194  
Cyl. 1-4

**15-37332-01**  
11 12 7 513 195  
Cyl. 5-8

**12-37281-01** 2x  
11 34 0 054 492

**71-39409-00**  8x  
11 61 7 537 999

**71-31834-10**  4x  
11 62 7 505 789

**71-34067-00**  
11 13 7 506 774

**71-34069-00**  
11 13 7 545 293

**81-34062-00**   
11 14 7 647 380  
45x75  
RD FPM

**81-90001-00**   
11 14 7 512 101  
100 Ø  
LD PTFE

4,8 N62 B48 B 270 kW (367 PS) 650 i (E64) 09/05-08/10

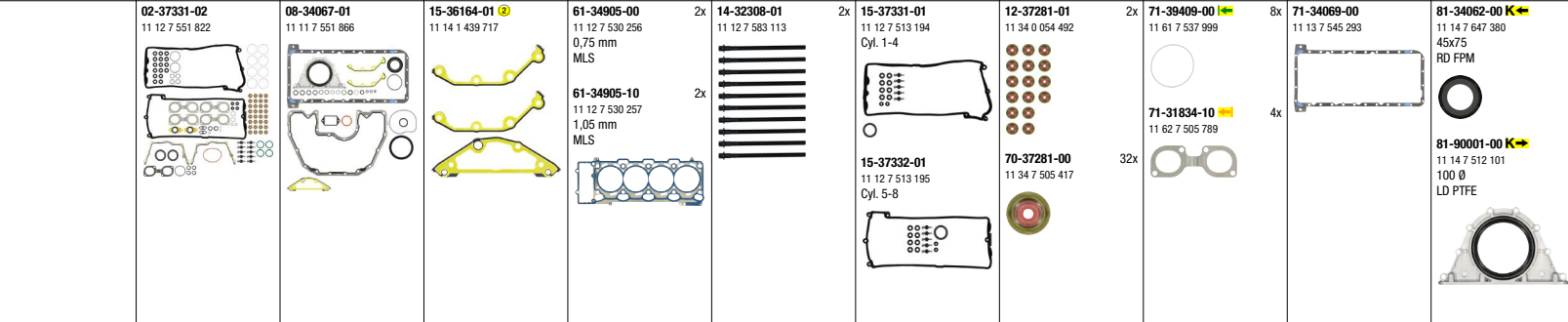

**02-37331-02**  
11 12 7 551 822

**08-34067-01**  
11 11 7 551 866

**15-36164-01**   
11 14 1 439 717

**61-34905-00** 2x  
11 12 7 530 256  
0,75 mm  
MLS

**61-34905-10** 2x  
11 12 7 530 257  
1,05 mm  
MLS

**14-32308-01** 2x  
11 12 7 583 113

**15-37331-01**  
11 12 7 513 194  
Cyl. 1-4

**15-37332-01**  
11 12 7 513 195  
Cyl. 5-8

**12-37281-01** 2x  
11 34 0 054 492

**71-39409-00**  8x  
11 61 7 537 999























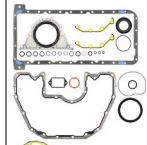
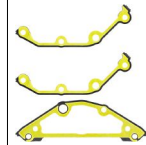
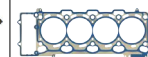
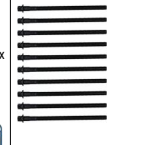
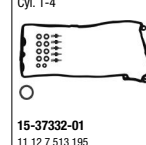
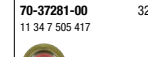
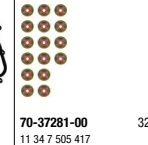



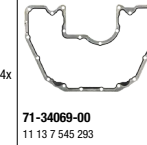
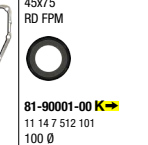
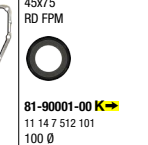

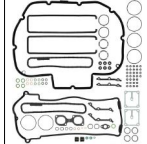

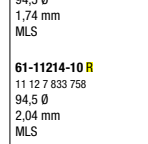
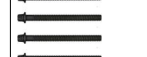
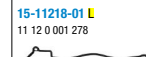
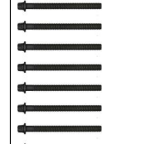
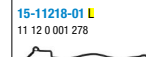
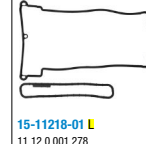
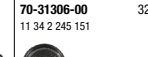
**71-31834-10**  4x  
11 62 7 505 789

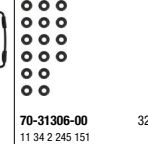
**71-34069-00**  
11 13 7 545 293

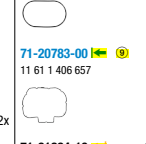

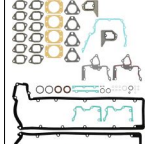



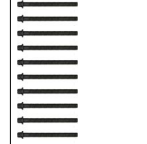
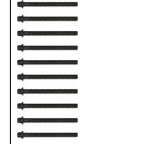
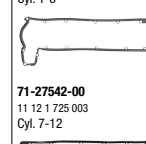
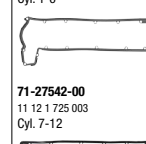

















**81-34062-00**   
11 14 7 647 380  
45x75  
RD FPM

















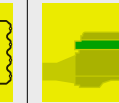
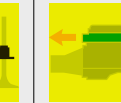
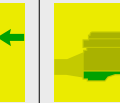



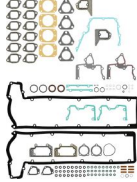



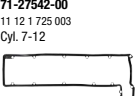
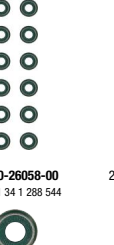



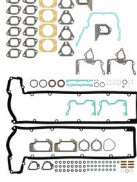
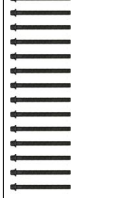

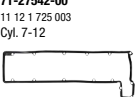
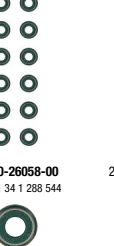



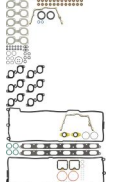

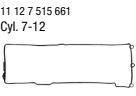

**81-90001-00**   
11 14 7 512 101  
100 Ø  
LD PTFE

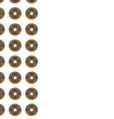
BMW

<p>Ltr. </p>											
<p>4,8 N62 B48 B 270 kW (367 PS) 750 iLi (E65,E66) 03/05-08/08</p>	<p><b>02-37331-02</b> 1x 11 12 7 551 822</p> 	<p><b>08-34067-01</b> 1x 11 11 7 551 866</p> 	<p><b>15-36164-01</b> 2x 11 14 1 439 717</p> 	<p><b>61-34905-00</b> 2x 11 12 7 530 256 0,75 mm MLS</p> <p><b>61-34905-10</b> 2x 11 12 7 530 257 1,05 mm MLS</p> 	<p><b>14-32308-01</b> 2x 11 12 7 583 113</p> 	<p><b>15-37331-01</b> 2x 11 12 7 513 194 Cyl. 1-4</p>  <p><b>15-37332-01</b> 2x 11 12 7 513 195 Cyl. 5-8</p> 	<p><b>12-37281-01</b> 2x 11 34 0 054 492</p>  <p><b>70-37281-00</b> 32x 11 34 7 505 417</p> 	<p><b>71-39409-00</b> 8x 11 61 7 537 999</p>  <p><b>71-31834-10</b> 4x 11 62 7 505 789</p>  <p><b>71-37337-00</b> 4x 11 62 7 505 788</p> 	<p><b>71-34067-00</b> 8x 11 13 7 506 774</p>  <p><b>71-34069-00</b> 8x 11 13 7 545 293</p> 	<p><b>81-34062-00</b> K↔ 11 14 7 647 380 45x75 RD FPM</p>  <p><b>81-90001-00</b> K↔ 11 14 7 512 101 100 Ø LD PTFE</p> 	
<p>4,9 S62 B50 (508S1) 294 kW (400 PS) M5 (E39) Z8 (E52) 10/98-12/03</p> <p><b>[NEW]</b></p>	<p><b>02-11343-01</b> 1x 11 12 1 407 805</p> 	<p><b>61-11214-00 R</b> 1x 11 12 1 407 800 94,5 Ø 1,74 mm MLS</p> <p><b>61-11214-10 R</b> 1x 11 12 7 833 758 94,5 Ø 2,04 mm MLS</p> <p><b>61-11215-00 L</b> 1x 11 12 1 407 801 94,5 Ø 1,74 mm MLS</p> <p><b>61-11215-10 L</b> 1x 11 12 7 833 759 94,5 Ø 2,04 mm MLS</p>	<p><b>14-32005-01</b> 2x 11 12 7 583 115</p> 	<p><b>15-11217-01 R</b> 2x 11 12 0 001 269</p>  <p><b>15-11218-01 L</b> 2x 11 12 0 001 278</p>  <p><b>71-33398-00</b> 2x</p> 	<p><b>12-31306-12</b> 2x 11 34 9 063 193</p>  <p><b>70-31306-00</b> 32x 11 34 2 245 151</p> 	<p><b>71-20783-00</b> 8x 11 61 1 406 657</p>  <p><b>71-31834-10</b> 3x 11 62 7 505 789</p>  <p><b>71-31836-10</b> 1x 11 62 7 509 677</p>  <p><b>71-31833-00</b> 2x 18 30 1 728 734</p> 	<p><b>71-27543-00</b> 12x 11 62 1 708 965</p>  <p><b>71-27467-00</b> 4x 11 76 1 711 717</p> 	<p><b>81-17404-50</b> K↔ 11 14 1 265 431 48x65 AB SL RD FPM</p>  <p><b>81-27373-00</b> K↔ 11 14 1 713 730 100x125 A SL LD FPM</p> 			
<p>5,0 M70 B50 (5012A) 220 kW (300 PS) 750 iLi (E32) 850 iCi (E31) 09/87-09/94</p>	<p><b>02-27541-02</b> 1x 11 12 9 059 239</p> 	<p><b>08-13047-02</b> 1x 11 11 9 059 235</p> 	<p><b>14-32005-02</b> 2x 11 12 7 583 116</p> 	<p><b>71-27541-00</b> 2x 11 12 1 725 002 Cyl. 1-6</p>  <p><b>71-27542-00</b> 2x 11 12 1 725 003 Cyl. 7-12</p> 	<p><b>12-26058-01</b> 24x 11 34 9 059 172</p>  <p><b>70-26058-00</b> 24x 11 34 1 288 544</p> 	<p><b>81-27373-00</b> K↔ 11 14 1 713 730 100x125 A SL LD FPM</p> 					

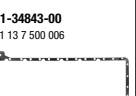
BMW

Ltr.															
5,0	S85 B50 A	373 kW (507 PS)	M5 (E60) M5 (E61) M6 (E63) M6 (E64)	09/04-12/10											
								<p><b>61-11213-00</b> 2x 11 12 7 837 460 92,8 Ø 0,6 mm MLS</p> <p><b>14-32005-02</b> 11 12 7 583 116 05/08</p> <p><b>71-41283-00</b> 11 12 7 834 110 Cyl. 1-5</p> <p><b>71-41284-00</b> 11 12 7 834 111 Cyl. 6-10</p> <p><b>14-12256-01</b> 11 12 7 838 831 06/08→</p>	<p><b>12-33457-01</b> 2x 11 34 0 032 548</p> <p><b>70-33457-00</b> 11 34 1 340 849</p>	<p><b>71-41333-00</b> 10x 13 54 7 834 023</p> <p><b>71-41327-00</b> 10x 11 62 7 833 278</p>	<p><b>71-41293-00</b> 11 13 7 836 361</p>	<p><b>81-38031-00 K→</b> 11 21 7 838 072 48x65 LD FPM</p> <p><b>81-38033-00 K→</b> 11 21 7 838 071 100x125 LD FPM</p>			
5,4	M73 B54 M73 B54 (54121) M73 B54 (54122)	240 kW (326 PS)	750 i, iL (E38) 850 Ci (E31)	09/94				<p><b>61-29315-00</b> 11 12 1 702 082 86 Ø 1,75 mm Cyl. 1-6</p> <p><b>61-29320-00</b> 11 12 1 702 083 86 Ø 1,75 mm Cyl. 7-12</p>	<p><b>14-32005-02</b> 11 12 7 583 116</p>	<p><b>71-27541-00</b> 11 12 1 725 002 Cyl. 1-6</p> <p><b>71-27542-00</b> 11 12 1 725 003 Cyl. 7-12</p>	<p><b>12-26058-01</b> 24x 11 34 9 059 172</p> <p><b>70-26058-00</b> 11 34 1 288 544</p>	<p><b>71-34849-00</b> 8x 11 62 1 704 539</p> <p><b>71-34851-00</b> 4x 11 62 1 704 540</p>	<p><b>81-27373-00 K→</b> 11 14 1 713 730 100x125 A SL LD FPM</p>		
5,4	M73 B54 (54122)	243 kW (330 PS)	750 i (E38)	09/98-07/01				<p><b>61-29315-00</b> 11 12 1 702 082 86 Ø 1,75 mm Cyl. 1-6</p>	<p><b>14-32005-02</b> 11 12 7 583 116</p>	<p><b>71-27541-00</b> 11 12 1 725 002 Cyl. 1-6</p> <p><b>71-27542-00</b> 11 12 1 725 003 Cyl. 7-12</p>	<p><b>12-26058-01</b> 24x 11 34 9 059 172</p> <p><b>70-26058-00</b> 11 34 1 288 544</p>	<p><b>71-34849-00</b> 8x 11 62 1 704 539</p> <p><b>71-34851-00</b> 4x 11 62 1 704 540</p>	<p><b>81-27373-00 K→</b> 11 14 1 713 730 100x125 A SL LD FPM</p>		

BMW														
5,6	M70 B56	280 kW (380 PS)	 1		<b>02-27541-02</b> 11 12 9 059 239 	<b>08-13047-02</b> 11 11 9 059 235 			<b>14-32005-02</b> 11 12 7 583 116 	2x <b>71-27541-00</b> 11 12 1 725 002 Cyl. 1-6  <b>71-27542-00</b> 11 12 1 725 003 Cyl. 7-12 	<b>12-26058-01</b> 11 34 9 059 172  24x <b>70-26058-00</b> 11 34 1 288 544 	2x <b>71-27543-00</b> 11 62 1 708 965  <b>71-27467-00</b> 11 76 1 711 717  4x		<b>81-27373-00 K</b> 11 14 1 713 730 100x125 A SL LD FPM 
5,6	S70 B56 (56121)	277-280 kW (377-380 PS)	850 CSI (E31)	11/92-12/96	<b>02-27541-02</b> 11 12 9 059 239 				<b>14-32005-02</b> 11 12 7 583 116 	2x <b>71-27541-00</b> 11 12 1 725 002 Cyl. 1-6  <b>71-27542-00</b> 11 12 1 725 003 Cyl. 7-12 	<b>12-26058-01</b> 11 34 9 059 172  24x <b>70-26058-00</b> 11 34 1 288 544 	2x <b>71-27543-00</b> 11 62 1 708 965  <b>71-27467-00</b> 11 76 1 711 717  4x		<b>81-27373-00 K</b> 11 14 1 713 730 100x125 A SL LD FPM 
6,0	N73 B60 A	327 kW (445 PS)	760 iLi (E65,E66)	01/03-08/08	<b>02-41279-01</b> 11 12 0 152 551 	<b>08-34067-01</b> 11 11 7 551 866  <b>08-34067-02</b> 11 11 7 521 322 	<b>61-34080-00</b> 11 12 7 515 147 90 Ø 0,75 mm MLS 2x <b>61-34080-00</b> 11 12 7 515 147 90 Ø 0,75 mm MLS 2x <b>61-34080-10</b> 11 12 7 515 148 90 Ø 1,05 mm MLS 2x <b>61-34080-10</b> 11 12 7 515 148 90 Ø 1,05 mm MLS 2x 		<b>71-41279-00</b> 11 12 7 515 647 Cyl. 1-6  <b>71-41281-00</b> 11 12 7 515 661 Cyl. 7-12  <b>71-41282-00</b> 11 12 7 521 085 2x 	<b>12-41302-01</b> 11 34 0 030 707  2x <b>71-34129-00</b> 11 61 7 569 910  <b>71-41317-00</b> 11 61 1 440 321  6x <b>71-31834-10</b> 11 62 7 505 789  6x <b>71-34843-00</b> 11 13 7 500 006 	<b>71-34067-00</b> 11 13 7 506 774  <b>81-34062-00 K</b> 11 14 7 647 380 45x75 RD FPM  <b>81-90001-00 K</b> 11 14 7 512 101 100 Ø LD PTFE 			

BMW

Ltr.  6,0 N74 B60 A 400 kW (544 PS) 760 i (F01, F02)  09/09-12/15

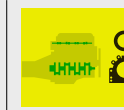

6,0 N74 B60 A 400 kW (544 PS) 760 i (F01, F02) 09/09-12/15

**61-37170-00** 2x  
11 12 7 584 618  
0,75 mm  
MLS

**61-37170-10** 2x  
11 12 7 584 612  
1,05 mm  
MLS



**12-37281-01** 3x  
11 34 0 054 492





**70-37281-00** 48x  
11 34 7 505 417



**71-11399-00**  18 30 7 553 601





**81-34062-00**  **K**  
11 14 7 647 380  
45x75  
RD FPM



6,6 N74 B66 C 430 kW (585 PS)

**81-34062-00**  **K**  
11 14 7 647 380  
45x75  
RD FPM



**81-10403-00**  **K**  
11 14 8 483 798  
PTFE



# Haftungsausschluss

## (für Katalog)

**Alle Angaben in unserem Katalog** wurden von uns sorgfältig geprüft, sind jedoch unverbindlich. Ersatzansprüche wegen Katalogangaben werden von uns nicht anerkannt. Der Käufer ist selbst verpflichtet, zu prüfen, ob unsere Teile für seine Zwecke geeignet sind. In allen Zweifelsfällen sollte Rücksprache mit unserem technischen Kundendienst erfolgen **Tel. +49 731 7046 999**.

**Technische Weiterentwicklungen** oder Änderungen bleiben vorbehalten, soweit damit keine Nachteile für den Kunden verbunden sind.

**Angaben, Namens- und Markenzeichen**, Beschreibungen, Nummern von Fahrzeugnummern und Herstellerzeichen, Original-Ersatzteilnummern der Fahrzeug- und Motorenhersteller u. a. sind ausschließlich für interne Zwecke gedacht. Solche Kennzeichnungen dürfen Fahrzeugbesitzern gegenüber nicht verwendet werden.

**Wir weisen ausdrücklich darauf hin**, dass alle von uns gelieferten Teile von geschultem Fachpersonal einzubauen sind. Reinz haftet für Fehler in diesem Katalog nur, wenn diese für den Kunden nicht offenbar erkennbar sind sowie nur bei Vorsatz und grober Fahrlässigkeit von Reinz, eines Vertreters oder eines Erfüllungsgehilfen. Dieser Haftungsausschluss gilt nicht im Rahmen

des Anwendungsbereichs des Produkthaftungsgesetzes und nicht bei Verletzung von Körper, Leben und Gesundheit, sowie bei der Verletzung von sog. Kardinalpflichten. Darüber hinaus ist unsere Haftung für Schäden, insbesondere für Personen-, Sach- oder Vermögensschäden, die unmittelbar oder mittelbar im Zusammenhang mit der Nutzung dieses Kataloges auftreten, sowie für nicht voraussehbare Schäden ausgeschlossen.

**Reinz ist Inhaber aller Schutzrechte** an den in diesem Katalog gespeicherten Daten. Kopie, Nachdruck, ganze oder teilweise Übernahme der Inhalte und Vervielfältigung, auch auszugsweise, ist nur mit unserer vorheriger schriftlicher Zustimmung sowie mit unserem Urheberrechtsvermerk zulässig.

Für Bestellungen, welche ab dem Erscheinungsdatum eines neuen Katalogs getätigt werden, sind alleine die Angaben des neuen Katalogs maßgeblich. Auf Angaben im Vorkatalog kann bei Neubestellungen nicht mehr zurückgegriffen werden.

**Sofern Sie noch Fragen haben, bitten wir Sie, sich mit uns in Verbindung zu setzen.**

VictorReinz.com/AGB

# Exclusion of Liability

## (for catalog)

**All details in our catalog** have been thoroughly checked by us but are however not binding. Right to damages on account of catalog details will not be recognized. The purchaser is obliged to check if our parts are suitable for their use. In all doubtful cases, the purchaser should consult our technical customer service under **+49 731 7046 999**.

**We reserve the right** to further technical developments or changes as long as no disadvantage for the customer results.

**Details, name and trademarks**, descriptions, numbers from vehicle numbers and manufacturer symbols, original vehicle replacement part numbers and engine manufacturer etc. are solely for internal use. Such labels must not be used with vehicle owners.

**We specifically point out** that all parts supplied by us must be assembled by trained specialists.

**Reinz is liable for mistakes** in this catalog only when they are not clearly recognizable for the customer, as well as by intent or gross negligence on the part of Reinz, its representative or vicarious agent. This exclusion of liability does not apply within the framework of the field of

application of the product liability laws and not by bodily harm, life and health, as well as by violation of cardinal duties. In addition, our liability for damages, especially personal, property or financial damages that occur directly or indirectly as a result of the use of this catalog, as well as non-foreseeable damages are excluded.

**Reinz is the owner of all patent rights** on the data stored in this catalog. Copies, reprints, whole or partial takeover of the contents and duplication even in excerpts are only permissible with our prior written approval, as well as with our copyright note.

**For orders placed after the publication date** of a new catalog, only the details in the new catalog are binding and no fall back to details in the previous catalog is possible.

**In case you have further questions, do not hesitate to contact us.**

VictorReinz.com/AGB

**VictorReinz.com**

**reinz.info@dana.com**

**Technical Hotline +49 (0)731 7046-9 99**

**REINZ-Dichtungs-GmbH**

Reinzstrasse 3-7  
89233 Neu-Ulm  
Germany  
+49 (0)731 7046-0

***VICTOR REINZ***<sup>®</sup>

---

