

**VICTOR REINZ®**

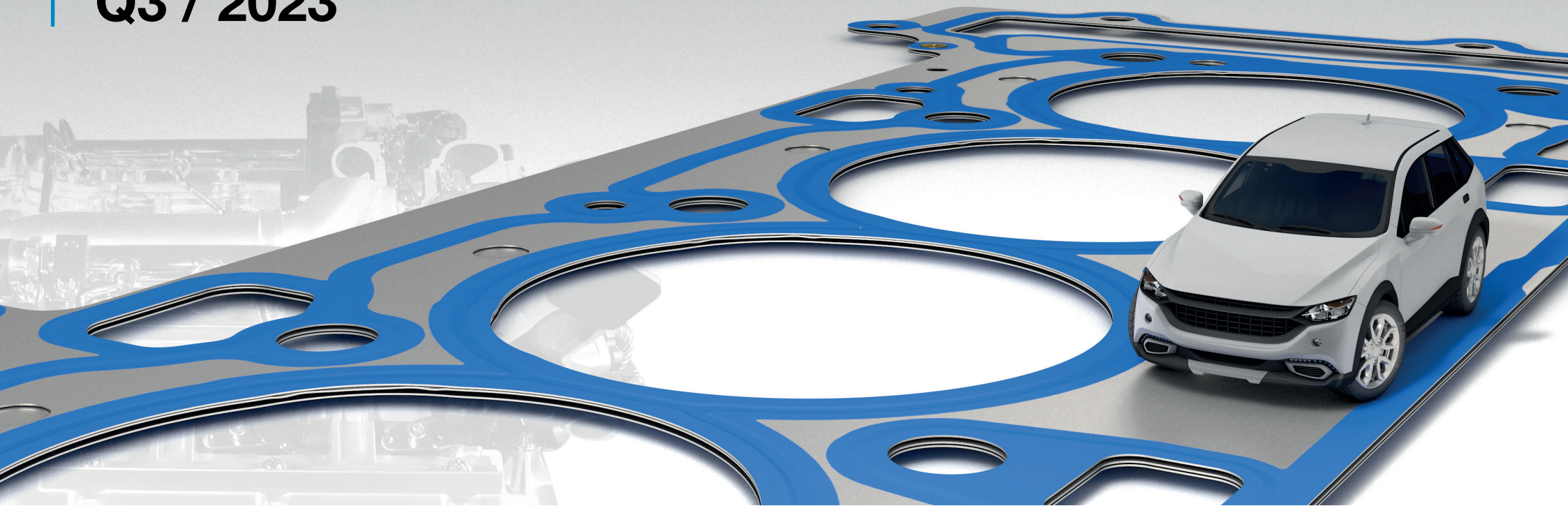

**CHRYSLER**  
**Q3 / 2023**



**[VictorReinz.com/online-catalog](https://VictorReinz.com/online-catalog)**

# Victor Reinz®

## at a Glance

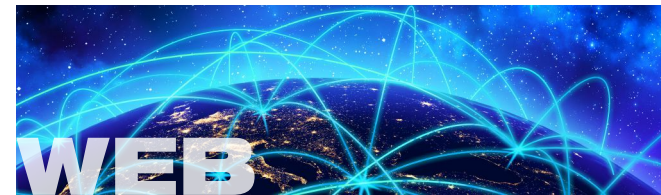

### Online Catalog

[VictorReinz.com/online-catalog](https://VictorReinz.com/online-catalog)



### Newsletter

[VictorReinz.com/EN/News/Newsletter.aspx?region](https://VictorReinz.com/EN/News/Newsletter.aspx?region)



### Youtube

[www.youtube.com/user/VictorReinzSealingEN](https://www.youtube.com/user/VictorReinzSealingEN)



### Catalog News

[VictorReinz.com/news](https://VictorReinz.com/news)



### Technical Service Information

[VictorReinz.com/tsi](https://VictorReinz.com/tsi)



### Facebook

[www.facebook.com/VictorReinzParts](https://www.facebook.com/VictorReinzParts)



### Just seal it!

[VictorReinz.com/jsi](https://VictorReinz.com/jsi)



### Technical Datasheet

[VictorReinz.com/jsi-datasheet](https://VictorReinz.com/jsi-datasheet)



### LinkedIn

[www.linkedin.com/showcase/victor-reinz-emea](https://www.linkedin.com/showcase/victor-reinz-emea)



### Safety Datasheet

[VictorReinz.com/jsi-datasheet](https://VictorReinz.com/jsi-datasheet)



### Homepage

[VictorReinz.com](https://VictorReinz.com)

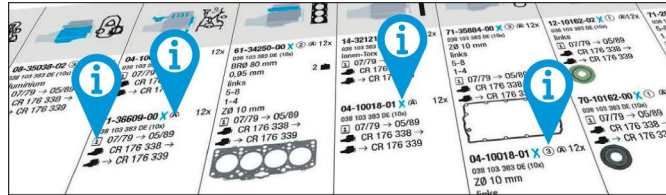

[VictorReinz.com/catalog-info](https://VictorReinz.com/catalog-info)

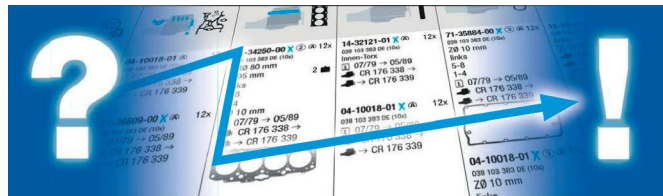

[VictorReinz.com/catalog-how-to-use](https://VictorReinz.com/catalog-how-to-use)

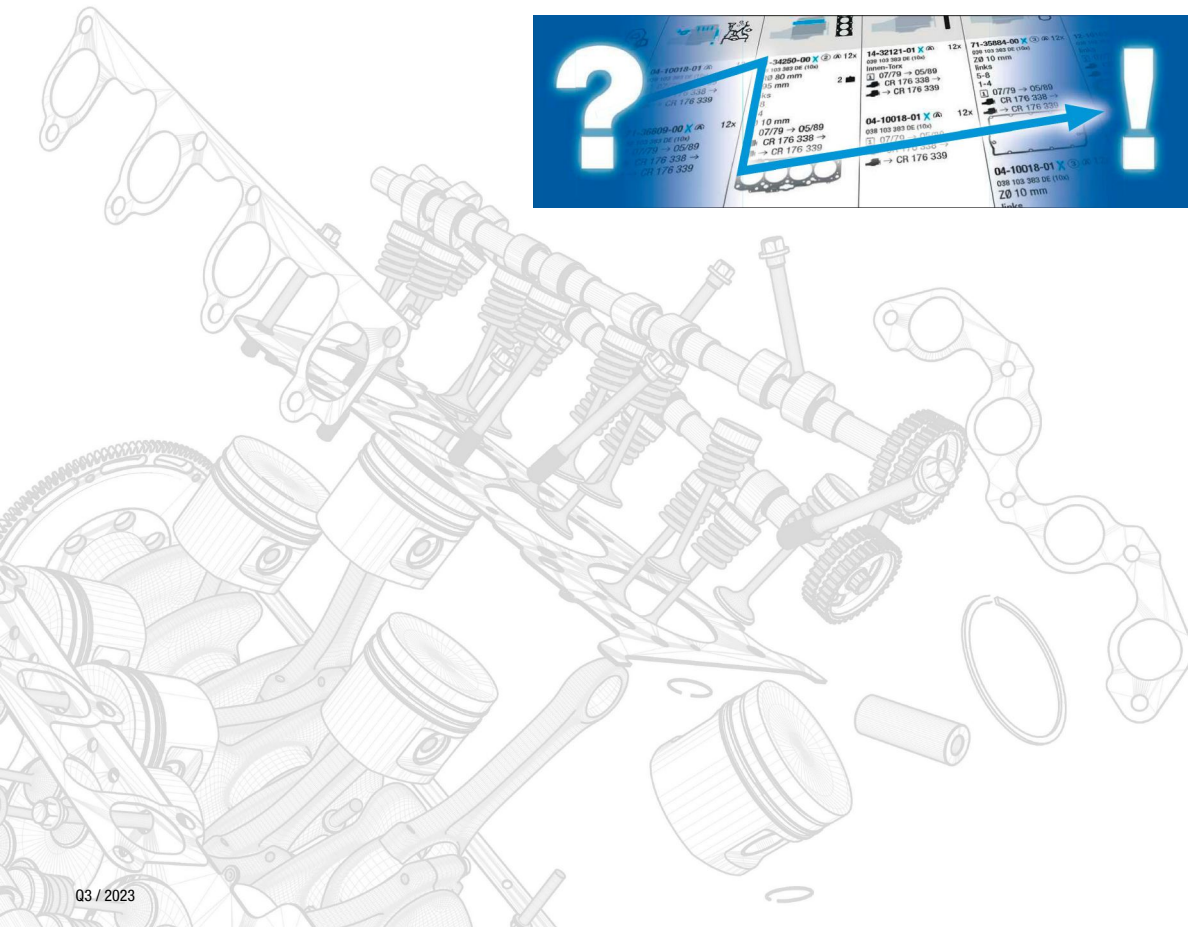

# CHRYSLER



**0-9**

09B ..... 16

169 A4.000 ..... 5

198 A2.000 ..... 7

198 A4.000 ..... 6

198 A5.000 ..... 9

198 A7.000 ..... 6

199 B1.000 ..... 5

312 A2.000 ..... 5

3E1 ..... 5

3G1A ..... 6

3Y2 ..... 6

425 CLIRS/X ..... 17

6G72 ..... 20

6Y2 ..... 6

**E**

ECC ..... 8

ECD ..... 9

ECN ..... 9

ED3 ..... 13

ED6 ..... 13

EDG ..... 10

EDJ ..... 10

EDK ..... 14

EDV ..... 11

EDZ ..... 11-13

EER ..... 17

EES ..... 17

EFA ..... 19

EGG ..... 21

EGX ..... 21

EGZ ..... 21

EJD ..... 7

ENC ..... 14-15

ENJ ..... 15

ENR ..... 18

ENS ..... 18

ERB ..... 22

ERH ..... 22

EVA ..... 22

EXF ..... 19

EXL ..... 19-20



**H**

HR 425 CLI ..... 16

**J**

J8S ..... 10

J8S 890 ..... 10

**M**

M00 ..... 16

**P**

P00 ..... 16

**R**

R00 ..... 21

**S**

S01 ..... 22



























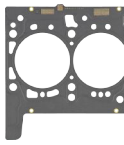

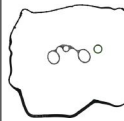
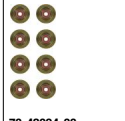





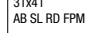
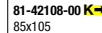

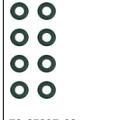



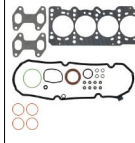
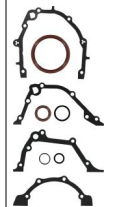



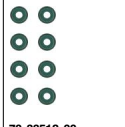







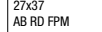
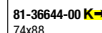



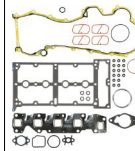

**V**

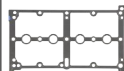
VM HR 425 CLIEE ..... 17





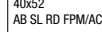
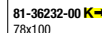











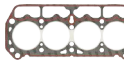







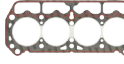









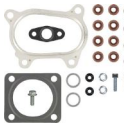

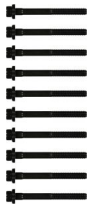
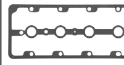













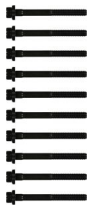

**Y**

Y2 ..... 6

CHRYSLER

<p>Ltr. </p>	<p>0,9 312 A2.000</p>	<p>63 kW (86 PS)</p>	<p>YPSILON </p>	<p>05/11 </p>											
<p>0,9 312 A2.000</p>	<p>63 kW (86 PS)</p>	<p>YPSILON</p>	<p>05/11</p>	<p><b>02-38860-01</b> </p>	<p><b>08-42098-01</b> </p>			<p><b>61-38860-00</b> 82,7 Ø MLS </p>	<p><b>14-32376-01</b> </p>	<p><b>15-42102-01</b> </p>	<p><b>12-42094-01</b>  <b>70-42094-00</b> 8x </p>	<p><b>11-42116-01</b>    <b>71-42103-00</b> </p>	<p><b>70-31414-10</b> </p>	<p><b>81-35882-00</b>  31x41 AB SL RD FPM  <b>81-42108-00</b>  85x105 AB RD FPM  </p>	
<p>1,1 3E1</p>	<p>37 kW (50 PS)</p>	<p>YPSILON</p>	<p>05/11</p>							<p><b>71-12902-00</b> </p>	<p><b>12-25837-01</b>  <b>70-25837-00</b> 8x </p>	<p><b>71-80769-00</b> </p>	<p><b>71-21718-00</b> </p>		
<p>1,2 169 A4.000</p>	<p>51 kW (69 PS)</p>	<p>YPSILON</p>	<p>05/11</p>	<p><b>02-36900-01</b> </p>	<p><b>08-37464-01</b> </p>			<p><b>61-36900-00</b> 72,5 Ø 0,5 mm MLS </p>	<p><b>14-32093-01</b> </p>	<p><b>15-37544-01</b> </p>	<p><b>12-33512-04</b>  <b>70-33512-00</b> 8x </p>	<p><b>11-37546-01</b>     <b>71-35617-00</b> </p>	<p><b>70-31414-10</b> </p>	<p><b>81-37461-00</b>  27x37 AB RD FPM  <b>81-36644-00</b>  74x88 AB SL LD FPM    <b>81-35623-00</b>  40x55 AB SL RD FPM/ACM  </p>	
<p>1,3 199 B1.000</p>	<p>70 kW (95 PS)</p>	<p>YPSILON</p>	<p>05/11</p>	<p><b>02-36259-04</b> </p>	<p><b>08-36261-05</b> </p>	<p><b>04-10324-02</b> </p>	<p><b>61-36210-00</b> 70,5 Ø 0,72 mm MLS <b>61-36210-10</b> 70,5 Ø 0,82 mm MLS <b>61-36210-20</b> 70,5 Ø 0,92 mm MLS </p>	<p><b>14-32191-01</b> </p>	<p><b>71-36259-00</b> </p>	<p><b>12-31306-12</b>  <b>70-31306-00</b> 16x 68001551AA </p>	<p><b>71-39538-00</b>  <b>71-36322-00</b> </p>	<p><b>70-31414-10</b> </p>	<p><b>81-36233-00</b>  40x52 AB SL RD FPM/ACM  <b>81-36232-00</b>  78x100 A SL LD PTFE  </p>		

CHRYSLER

<p>Ltr.  1,3 3G1A 45 kW (62 PS)   1</p>					<p>61-23440-10 78,5 Ø 1,2 mm</p> 		<p>71-12902-00</p> 	<p>70-20116-00 8x</p> 	<p>71-24161-00 </p> <p>71-80769-00 </p> 	<p>71-21718-00</p> 	
<p>1,4 Y2 3Y2 6Y2 61-62 kW (83-85 PS)</p>					<p>61-23440-10 78,5 Ø 1,2 mm</p> 		<p>71-12902-00</p> 	<p>70-20116-00 8x</p> 	<p>71-24161-00 </p> <p>71-80769-00 </p> 	<p>71-21718-00</p> 	
<p>1,4 198 A4.000 88 kW (120 PS) DELTA 08/11</p>		<p>02-38835-01</p> 	<p>08-90041-01</p> 	<p>04-10215-01 </p> 	<p>61-38835-00 73 Ø MLS</p> 	<p>14-35731-01</p> 	<p>71-35621-10</p> 	<p>12-33512-02</p> <p>70-33512-00 16x</p> 	<p>11-38834-01 </p> <p>71-38831-00 </p> 	<p>70-31414-10</p> 	<p>81-37461-00 </p> <p>27x37 AB RD FPM</p>  <p>81-90041-00 </p> <p>FPM/ACM</p>  <p>81-35623-00 <b>N</b></p> <p>40x55 AB SL RD FPM/ACM</p> 
<p>1,4 198 A7.000 103 kW (140 PS) DELTA 08/11</p>		<p>02-38835-02</p> 	<p>08-90041-03</p> 		<p>61-38835-00 73 Ø MLS</p> 	<p>14-35731-01</p> 	<p>15-42128-01</p> 	<p>12-33512-02</p> <p>70-33512-00 16x</p> 	<p>11-38834-01 </p> <p>71-42124-00 </p> 	<p>70-31414-10</p> 	<p>81-37461-00 </p> <p>27x37 AB RD FPM</p>  <p>81-90041-00 </p> <p>FPM/ACM</p>  <p>81-37459-00 <b>N</b></p> <p>31x55 AB SL RD FPM</p> 

CHRYSLER

Ltr. 1,6 EJD 85 kW (116 PS) NEON 11/01-12/06

	02-34787-01  02-34980-01 	08-34786-01 1 → 07/04  08-34786-02 1 → 08/04 → 		61-34980-00 04690383AA 78 Ø 0,65 mm MLS 61-34980-10 78 Ø 0,95 mm MLS 	14-32241-01 	15-34787-01  71-34787-00 	12-34783-01  70-34783-00 16x 	71-34784-00 71-34782-00	71-34786-00 		













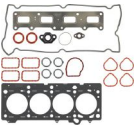



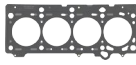

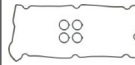

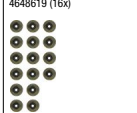























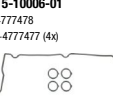
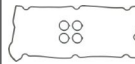
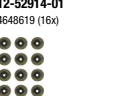
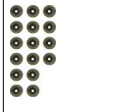

















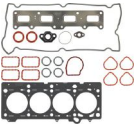

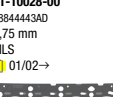



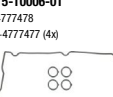
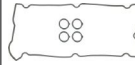
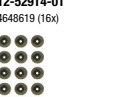
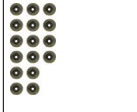





1,6 EJD 85 kW (116 PS) PT CRUISER 11/01-12/10

	02-34787-01  02-34980-01 	08-34786-01 1 → 07/04  08-34786-02 1 → 08/04 → 		61-34980-00 04690383AA 78 Ø 0,65 mm MLS 61-34980-10 78 Ø 0,95 mm MLS 	14-32241-01 	15-34787-01  71-34787-00 	12-34783-01  70-34783-00 	71-34784-00 71-34782-00	71-34786-00 		
--	------------------------------------	--	--	--	-----------------	------------------------------------	------------------------------------	----------------------------	-----------------	--	--

1,6 198 A2.000 88 kW (120 PS) DELTA D 08/11



	02-42061-02 	08-36278-03 		61-38200-00 80,5 Ø 0,82 mm MLS 61-38200-10 80,5 Ø 0,92 mm MLS 1 → 61-38200-20 80,5 Ø 1,02 mm MLS 2 → 	14-32363-01 	71-42061-00 	12-38209-02  70-38209-00 16x 	11-40692-01 71-39352-00 71-42073-00	70-31414-10 	81-35882-00 31x41 AB SL RD FPM 81-90027-00 93 Ø 81-36229-00 N 30x45 AB SL RD FPM 81-36229-00
--	-----------------	-----------------	--	---	-----------------	-----------------	--	---	-----------------	---

















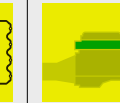
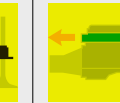
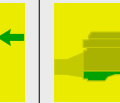
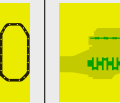
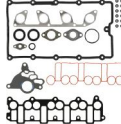

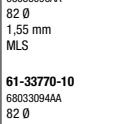
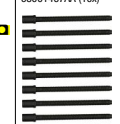
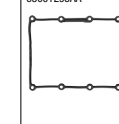
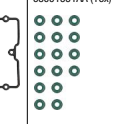

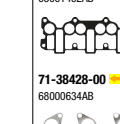
CHRYSLER

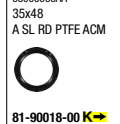
<p>Ltr.  2,0 ECC</p> <p>100-118 kW (136-160 PS)</p> <p>NEON NEON 16V PT CRUISER</p> <p>06/94-12/10 <b>[NEW]</b></p>		 <p><b>02-10028-01</b> 5083152AC</p> 			 <p><b>61-10028-00</b> 4884443AD 0,75 mm MLS</p> 		 <p><b>15-10006-01</b> 4777478 +4777477 (4x)</p> 	 <p><b>12-52914-01</b> 4648619 (16x)</p>  <p><b>70-34783-00</b></p> 	 <p><b>71-10183-00</b>  4x 4884649AA</p>  <p><b>71-10184-00</b>  4x 4884648AA</p>  <p><b>71-10190-00</b>  4781255AA</p> 	 <p><b>71-52917-00</b> 4556666</p> 	 <p><b>81-34805-00</b>  4x 4667198 32x45 A SL RD ACM</p>  <p><b>81-10673-00</b>  4621939AB 91x111 AB LD FPM</p> <p><b>81-24909-10 N</b> 2x 4777086 35x48 A SL RD MVQ</p> 
<p>2,0 ECC</p> <p>104 kW (141 PS)</p> <p>CIRRUS</p> <p>09/00-04/07 <b>[NEW]</b></p>		 <p><b>02-10028-01</b> 5083152AC</p> 			 <p><b>61-10028-00</b> 4884443AD 0,75 mm MLS</p> 		 <p><b>15-10006-01</b> 4777478 +4777477 (4x)</p> 	 <p><b>12-52914-01</b> 4648619 (16x)</p>  <p><b>70-34783-00</b></p> 	 <p><b>71-10183-00</b>  4x 4884649AA</p>  <p><b>71-10184-00</b>  4x 4884648AA</p>  <p><b>71-10190-00</b>  4781255AA</p> 	 <p><b>71-52917-00</b> 4556666</p> 	 <p><b>81-34805-00</b>  4x 4667198 32x45 A SL RD ACM</p>  <p><b>81-10673-00</b>  4621939AB 91x111 AB LD FPM</p> <p><b>81-24909-10 N</b> 2x 4777086 35x48 A SL RD MVQ</p> 
<p>2,0 ECC</p> <p>104 kW (141 PS)</p> <p>PT CRUISER SEBRING</p> <p>06/00-06/07 <b>[NEW]</b></p>		 <p><b>02-10028-01</b> 5083152AC  01/02→</p> 			 <p><b>61-10028-00</b> 4884443AD 0,75 mm MLS  01/02→</p> 		 <p><b>15-10006-01</b> 4777478 +4777477 (4x)</p> 	 <p><b>12-52914-01</b> 4648619 (16x)</p>  <p><b>70-34783-00</b></p> 	 <p><b>71-10183-00</b>  4x 4884649AA</p>  <p><b>71-10184-00</b>  4x 4884648AA</p>  <p><b>71-10190-00</b>  4781255AA</p> 	 <p><b>71-52917-00</b> 4556666</p> 	 <p><b>81-34805-00</b>  4x 4667198 32x45 A SL RD ACM</p>  <p><b>81-10673-00</b>  4621939AB 91x111 AB LD FPM</p> <p><b>81-24909-10 N</b> 2x 4777086 35x48 A SL RD MVQ</p> 



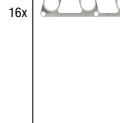



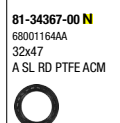







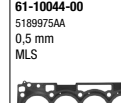
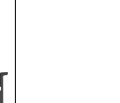
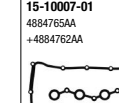
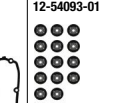
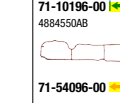





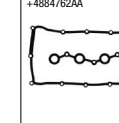
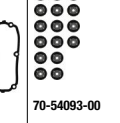

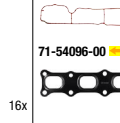
CHRYSLER



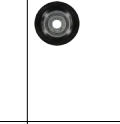



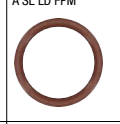







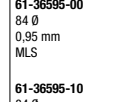
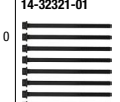
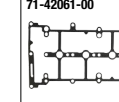
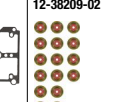
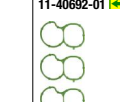

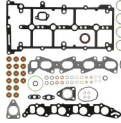

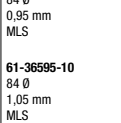
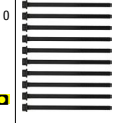
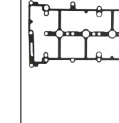
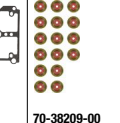

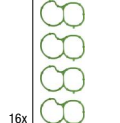
Ltr.  2,0 ECD 103 kW (140 PS) SEBRING CRD 07/07-12/10 

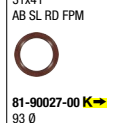
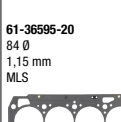
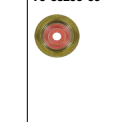
										
	02-36041-01 68033096AA 82 Ø 1,55 mm MLS 	08-35038-02 		61-33770-00 68033096AA 82 Ø 1,55 mm MLS 	14-32195-01 68001457AA (10x) 	71-36041-00 68001293AA 	12-31306-01 68001551AA (16x) 	71-36121-00  68001462AB 	70-31414-10 	81-34366-00  68000666AA 35x48 A SL RD PTFE ACM 
				61-33770-10 68033094AA 82 Ø 1,63 mm MLS 			70-31306-00 68001551AA 	71-38428-00  68000634AB 		81-90018-00  68000669AA PTFE 
				61-33770-20 68001272AA 82 Ø 1,71 mm MLS 						81-34367-00 <b>N</b> 68001164AA 32x47 A SL RD PTFE ACM 



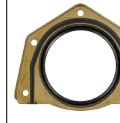
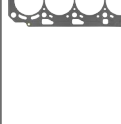

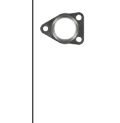









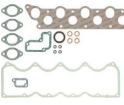

















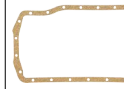











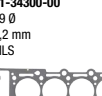











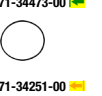
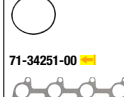





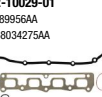



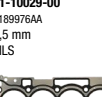
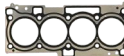

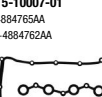
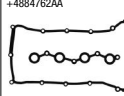



2,0 ECN 115 kW (156 PS) SEBRING 07/07-12/10

										
	02-10044-01 5189954AA 	08-54097-01 5189957AD 		61-10044-00 5189975AA 0,5 mm MLS 		15-10007-01 4884765AA +4884762AA 	12-54093-01 	71-10196-00  4884550AB 	70-31414-10 	81-54097-00  42x55 A SL RD FPM 
							70-54093-00 	71-54096-00  		81-54098-00  85x103 A SL LD FPM 

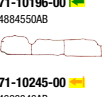











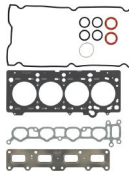

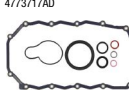

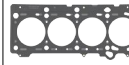



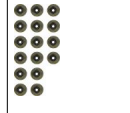













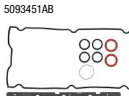
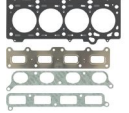



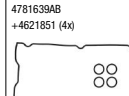
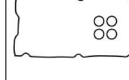
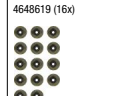
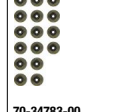







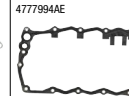





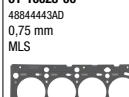
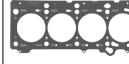

2,0 198 A5.000 121 kW (165 PS) DELTA D 08/11

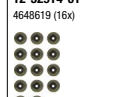
										
	02-42061-02 	08-36278-03 		61-36595-00 84 Ø 0,95 mm MLS 	14-32321-01 	71-42061-00 	12-38209-02 	11-40692-01  	70-31414-10 	81-35882-00  31x41 AB SL RD FPM 
				61-36595-10 84 Ø 1,05 mm MLS 			70-38209-00 	71-39352-00  		81-90027-00  93 Ø 
				61-36595-20 84 Ø 1,15 mm MLS 				71-42072-00   		81-36229-00 <b>N</b> 30x45 AB SL RD FPM 













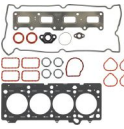

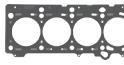

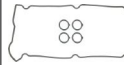
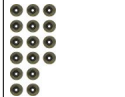











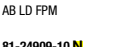



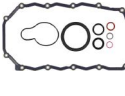

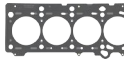

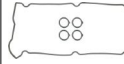

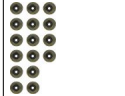









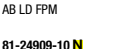

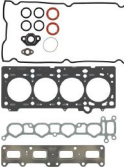

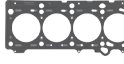



CHRYSLER

<p>Ltr.  1</p> <p>2,1 J8S J8S 890</p> <p>59-64 kW (80-87 PS)</p> 		 <p>02-25502-03</p> 	 <p>08-12972-03</p> 		 <p>61-29060-00 87 Ø 1,75 mm</p> <p>61-29060-10 87 Ø 1,6 mm </p> <p>61-29060-20 87 Ø 1,8 mm </p> 		 <p>71-25502-10</p> 	 <p>12-25837-01</p>  <p>70-25837-00 8x</p> 	 <p>71-24889-50  </p> 	 <p>71-12972-00</p> 	 <p>81-16737-20 </p> <p>50x68 A SL RD FPM</p>  <p>81-20745-30 </p> <p>90x110 A SL LD FPM</p>  <p>81-15855-40 <b>N</b></p> <p>35x47 A RD FPM</p> 
<p>2,2 EDJ</p> <p>89-110 kW (121-150 PS)</p> <p>PT CRUISER PT CRUISER CRD</p> <p>03/02-12/10</p>		 <p>02-31555-01</p> 	 <p>08-34037-02</p> 		 <p>61-34300-00 89 Ø 1,2 mm MLS</p> 	 <p>14-32109-01</p> 	 <p>12-29491-01</p>  <p>70-29491-00 16x</p> <p>5086290AA</p> 	 <p>71-34473-00  </p> <p>4x</p>  <p>71-34251-00 </p> 	 <p>71-34037-00</p> 	 <p>81-26248-10 </p> <p>5073675AB 45x67 A SL RD PTFE</p>  <p>81-90002-00 </p> 	
<p>2,4 EDG</p> <p>125-129 kW (170-175 PS)</p> <p>SEBRING 200</p> <p>09/06</p>		 <p>02-10029-01</p> <p>5189956AA +68034275AA</p> 	 <p>08-54097-01</p> <p>5189957AD</p> 		 <p>61-10029-00</p> <p>5189976AA 0,5 mm MLS</p> 	 <p>15-10007-01</p> <p>4884765AA +4884762AA</p> 	 <p>12-54093-01</p>  <p>70-54093-00 16x</p> 	 <p>71-10196-00  </p> <p>4884550AB</p>  <p>71-10245-00 </p> <p>4693346AB</p> 	 <p>70-31414-10</p> 	 <p>81-54097-00 </p> <p>42x55 A SL RD FPM</p>  <p>81-54098-00 </p> <p>85x103 A SL LD FPM</p> 	





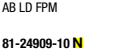



















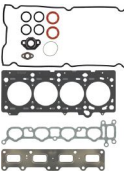

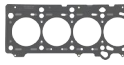
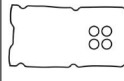









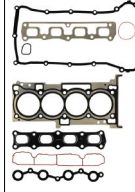

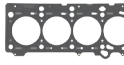
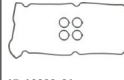









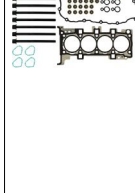



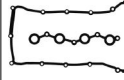











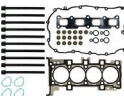

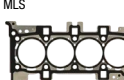
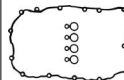
CHRYSLER

<p>Ltr.  2,4 EDV</p> <p>125-164 kW (170-223 PS)</p> <p>CIRRUS SEBRING STRATUS</p> <p>01/96-06/07 <b>[NEW]</b></p>		 <p>02-10028-06</p> 	 <p>08-10205-01 4773717AD</p> 		 <p>61-10028-00 4884443AD 0,75 mm MLS</p> 		 <p>15-10008-01 4781639AB +4621851 (4x)</p> 	 <p>12-52914-01 4648619 (16x)</p>  <p>70-34783-00 16x</p> 	 <p>71-10217-00  4781278AA</p>  <p>71-10190-00  4781255AA</p> 	 <p>71-10205-00 4621579</p> 	 <p>81-34805-00  4667198 32x45 A SL RD ACM</p>  <p>81-10673-00  4621939AB 91x111 AB LD FPM</p> <p>81-24909-10 <b>N</b> 2x 4777086 35x48 A SL RD MVQ</p> 
<p>2,4 EDV</p> <p>134-172 kW (182-234 PS)</p> <p>PT CRUISER</p> <p>08/03-12/10 <b>[NEW]</b></p>		 <p>02-10028-02 5093451AB</p> 	 <p>08-10211-01 5093452AA</p> 		 <p>61-10028-00 4884443AD 0,75 mm MLS</p> 		 <p>15-10008-01 4781639AB +4621851 (4x)</p> 	 <p>12-52914-01 4648619 (16x)</p>  <p>70-34783-00 16x</p> 	 <p>71-10197-00  4884195AA</p>  <p>71-10198-00  4884192AA</p>  <p>71-10199-00  4884447AA</p> 	 <p>71-10211-00 4777994AE</p> 	 <p>81-34805-00  4667198 32x45 A SL RD ACM</p>  <p>81-10673-00  4621939AB 91x111 AB LD FPM</p> <p>81-24909-10 <b>N</b> 2x 4777086 35x48 A SL RD MVQ</p> 
<p>2,4 EDZ</p> <p>103-112 kW (140-152 PS)</p> <p>CIRRUS STRATUS 16V</p> <p>05/94-04/01 <b>[NEW]</b></p>					 <p>61-10028-00 4884443AD 0,75 mm MLS</p> 		 <p>12-52914-01 4648619 (16x)</p>  <p>70-34783-00</p> 	 <p>71-10190-00  4781255AA</p> 			 <p>81-34805-00  4667198 32x45 A SL RD ACM</p>  <p>81-10673-00  4621939AB 91x111 AB LD FPM</p> <p>81-24909-10 <b>N</b> 2x 4777086 35x48 A SL RD MVQ</p> 

























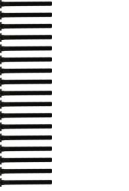
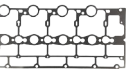

























CHRYSLER

<p>Ltr.  2,4 EDZ</p> <p>105-112 kW (143-152 PS)</p> <p>CIRRUS PT CRUISER</p> <p>09/94-12/10 <b>[NEW]</b></p>		<p><b>02-10028-01</b> 5083152AC</p> 	<p><b>08-10211-01</b> 5093452AA</p> 		<p><b>61-10028-00</b> 4884443AD 0,75 mm MLS</p> 		<p><b>15-10006-01</b> 4777478 +4777477 (4x)</p> 	<p><b>12-52914-01</b> 4648619 (16x)</p>  <p><b>70-34783-00</b> 16x</p> 	<p><b>71-10183-00</b>  4x 4884649AA</p>  <p><b>71-10184-00</b>  4x 4884648AA</p>  <p><b>71-10190-00</b>  4781255AA</p> 	<p><b>71-10211-00</b> 4777994AE</p> 	<p><b>81-34805-00</b>  4667198 32x45 A SL RD ACM</p>  <p><b>81-10673-00</b>  4621939AB 91x111 AB LD FPM</p>  <p><b>81-24909-10</b> <b>N</b> 2x 4777086 35x48 A SL RD MVQ</p> 
<p>2,4 EDZ</p> <p>105-112 kW (143-152 PS)</p> <p>PT CRUISER SEBRING</p> <p>06/00-12/10 <b>[NEW]</b></p>		<p><b>02-10028-05</b> 5083153AC</p> 	<p><b>08-10205-01</b> 4773717AD</p> 		<p><b>61-10028-00</b> 4884443AD 0,75 mm MLS</p> 		<p><b>15-10006-01</b> 4777478 +4777477 (4x)</p>  <p><b>15-10008-01</b> 4781639AB +4621851 (4x)</p> 	<p><b>12-52914-01</b> 4648619 (16x)</p>  <p><b>70-34783-00</b> 16x</p> 	<p><b>71-10209-00</b>  4x 4792485AA</p>  <p><b>71-10190-00</b>  4781255AA</p> 	<p><b>71-10205-00</b> 4621579</p> 	<p><b>81-34805-00</b>  4667198 32x45 A SL RD ACM</p>  <p><b>81-10673-00</b>  4621939AB 91x111 AB LD FPM</p>  <p><b>81-24909-10</b> <b>N</b> 2x 4777086 35x48 A SL RD MVQ</p> 
<p>2,4 EDZ</p> <p>108-111 kW (147-151 PS)</p> <p>CARAVAN GRAND CARAVAN GRAND VOYAGER</p> <p>01/95-12/08 <b>[NEW]</b></p>		<p><b>02-10028-03</b> 5083919AB</p> 	<p><b>08-10205-01</b> 4773717AD</p> 		<p><b>61-10028-00</b> 4884443AD 0,75 mm MLS</p> 		<p><b>15-10008-01</b> 4781639AB +4621851 (4x)</p> 	<p><b>12-52914-01</b> 4648619 (16x)</p> 	<p><b>71-10217-00</b>  4781278AA</p>  <p><b>71-10190-00</b>  4781255AA</p> 	<p><b>71-10205-00</b> 4621579</p> 	<p><b>81-34805-00</b>  4667198 32x45 A SL RD ACM</p>  <p><b>81-10673-00</b>  4621939AB 91x111 AB LD FPM</p>  <p><b>81-24909-10</b> <b>N</b> 2x 4777086 35x48 A SL RD MVQ</p> 







































CHRYSLER

<p>Ltr. </p>	<p>2,4 EDZ</p>	<p>111 kW (151 PS)</p>	<p>VOYAGER</p>	<p>02/97-12/07</p>	<p> <b>[NEW]</b></p>											
<p>2,4 EDZ</p>	<p>112 kW (152 PS)</p>	<p>SEBRING</p>	<p>09/95-12/98</p>	<p><b>[NEW]</b></p>		<p>02-10028-03 5083919AB</p> 	<p>08-10205-01 4773717AD</p> 	<p>61-10028-00 4884443AD 0,75 mm MLS</p> 	<p>15-10008-01 4781639AB +4621851 (4x)</p> 	<p>12-52914-01 4648619 (16x)</p> 	<p>71-10217-00  4781278AA</p> 	<p>71-10205-00 4621579</p> 	<p>81-34805-00  4667198 32x45 A SL RD ACM</p> 	<p>81-10673-00  4621939AB 91x111 AB LD FPM</p> 	<p>81-24909-10 <b>N</b> 2x 4777086 35x48 A SL RD MVQ</p> 	
<p>2,4 EDZ</p>	<p>125-129 kW (170-175 PS)</p>	<p>SEBRING 200</p>	<p>07/07-12/14</p>		<p>02-10028-05 5083153AC</p> 	<p>08-10205-01 4773717AD</p> 	<p>61-10028-00 4884443AD 0,75 mm MLS</p> 	<p>15-10006-01 4777478 +4777477 (4x)</p> 	<p>15-10008-01 4781639AB +4621851 (4x)</p> 	<p>12-52914-01 4648619 (16x)</p> 	<p>71-10209-00  4792485AA</p> 	<p>71-10205-00 4621579</p> 	<p>81-34805-00  4667198 32x45 A SL RD ACM</p> 	<p>81-10673-00  4621939AB 91x111 AB LD FPM</p> 	<p>81-24909-10 <b>N</b> 2x 4777086 35x48 A SL RD MVQ</p> 	
<p>2,4 ED3</p>	<p>125-129 kW (170-175 PS)</p>	<p>SEBRING 200</p>	<p>07/07-12/14</p>		<p>02-10029-01 5189956AA +68034275AA</p> 	<p>08-54097-01 5189957AD</p> 	<p>61-10029-00 5189976AA 0,5 mm MLS</p> 	<p>15-10007-01 4884765AA +4884762AA</p> 	<p>12-54093-01 4648619 (16x)</p> 	<p>71-10196-00  4884550AB</p> 	<p>71-54096-00  4781255AA</p> 	<p>70-31414-10</p> 	<p>81-54097-00  42x55 A SL RD FPM</p> 	<p>81-54098-00  85x103 A SL LD FPM</p> 		
<p>2,4 ED6</p>	<p>137 kW (186 PS)</p>	<p>200</p>	<p>06/14</p>		<p>02-10068-01</p> 	<p>14-10883-02</p> 	<p>61-10068-00 MLS</p> 	<p>15-10429-01</p> 	<p>12-11136-01</p> 	<p>71-10426-00  4781255AA</p> 	<p>71-10425-00  4781255AA</p> 	<p>70-31414-10</p> 	<p>81-54097-00  42x55 A SL RD FPM</p> 	<p>81-54098-00  85x103 A SL LD FPM</p> 		

CHRYSLER











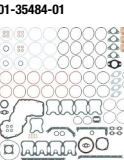

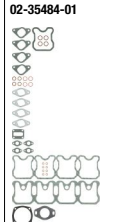







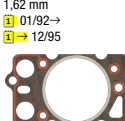



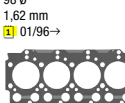

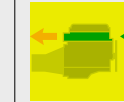







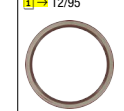

<p>Ltr. </p>	<p>2,5 EDK 88 kW (120 PS) VOYAGER CRD 08/05-12/08 </p>											
<p>2,5 ENC 85 kW (116 PS) GRAND VOYAGER VOYAGER 01/95-03/01</p>					<p>61-10037-00 1,32 mm MLS</p> <p>61-10037-10 1,42 mm MLS</p> <p>61-10037-20 1,52 mm MLS</p> 	<p>14-10569-01</p> 	<p>71-10345-00 5066786AA</p> 		<p>71-10327-00 </p> <p>5093904AA</p> 	<p>71-10349-00 5066901AA</p> 	<p>81-33636-00 N 30x47 B LD NBR</p> 	
<p>2,5 ENC 85 kW (116 PS) VOYAGER TD 01/95-03/01</p>					<p>61-35415-00 98 Ø 1,42 mm</p> <p>61-35415-10 98 Ø 1,52 mm</p> <p>61-35415-20 98 Ø 1,62 mm</p> 		<p>71-10224-00  01/96→</p> 	<p>12-34914-05</p> 	<p>71-35481-00  4x  12/96</p>  <p>71-10579-00  4x  01/97→</p>  <p>71-10476-00  4x  12/96</p> 	<p>70-31414-10</p> 	<p>81-10392-00  K 52x68 PTFE</p>  <p>81-42886-00  K 110x130 A SL RD PTFE (Polytetrafluorethylen)/ACM (Polyacryl-Kautschuk)</p> 	
<p>2,5 ENC 85 kW (116 PS) VOYAGER TDIC 10/95-03/01</p>				<p>04-10148-01 </p> 	<p>61-35415-00 98 Ø 1,42 mm</p> <p>61-35415-10 98 Ø 1,52 mm</p> <p>61-35415-20 98 Ø 1,62 mm</p> 		<p>71-10224-00</p> 		<p>71-35481-00  4x</p>  <p>71-10579-00  4x  01/97→</p>  <p>71-10476-00 </p> 		<p>81-10392-00  K 52x68 PTFE</p> 	

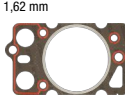
CHRYSLER

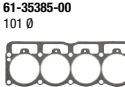
<p>Ltr.  2,5 ENC</p> <p>102 kW (139 PS)</p> <p> GRAND CARAVAN</p> <p> 02/06-05/07</p>					 <p>61-35415-00 98 Ø 1,42 mm</p> <p>61-35415-10 98 Ø 1,52 mm</p> <p>61-35415-20 98 Ø 1,62 mm</p> 		 <p>71-10224-00</p> 	 <p>12-34914-05</p> 	 <p>71-10579-00   </p> 	 <p>70-31414-10</p> 	 <p>81-10392-00 </p> <p>52x68 PTFE</p>  <p>81-42886-00 </p> <p>110x130 A SL RD PTFE (Polytetrafluorethylen)/ACM (Polyacryl-Kautschuk)</p> 
<p>2,5 ENJ</p> <p>105 kW (141-143 PS)</p> <p> RAM VOYAGER VOYAGER CRD</p> <p>02/00-12/08</p>					<p>61-10037-00 1,32 mm MLS</p> <p>61-10037-10 1,42 mm MLS </p> <p>61-10037-20 1,52 mm MLS </p> 		<p>71-10345-00 5066786AA</p> 		<p>71-10327-00 </p> <p>5093904AA</p> 	<p>71-10349-00 5066901AA</p> 	<p>81-10413-00 </p> <p>PTFE</p>  <p>81-10414-00 </p> <p>120x140 PTFE</p>  <p>81-33636-00 <b>N</b></p> <p>30x47 B LD NBR</p> 

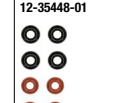
CHRYSLER













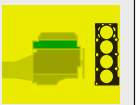
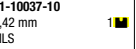



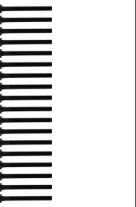

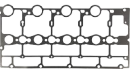



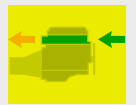









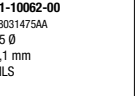
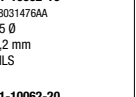



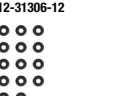

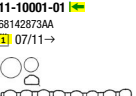

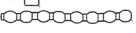



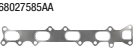









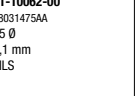
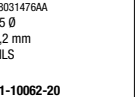





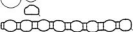

Ltr.  2,5 HR 425 CLI  88 kW (120 PS)  1

 <p>01-35484-01</p> 	 <p>02-35484-01</p> 			 <p>61-35410-00 4x 98,5 Ø 1,42 mm  01/92→  ⇒ 12/95</p> <p>61-35410-10 4x 98,5 Ø 1,52 mm  01/92→  ⇒ 12/95</p> <p>61-35410-20 4x 98,5 Ø 1,62 mm  01/92→  ⇒ 12/95</p>  <p>61-35415-00 98 Ø 1,42 mm  01/96→</p> <p>61-35415-10 98 Ø 1,52 mm  01/96→</p> <p>61-35415-20 98 Ø 1,62 mm  01/96→</p> 		 <p>71-35484-00</p> 		 <p>71-35481-00  4x</p>  <p>71-35482-00  4x</p> 		 <p>81-25587-00  4x</p> <p>52x68 A SL RD MVQ</p>  <p>81-35478-00  4x</p> <p>110x130 B SL LD FPM  01/92→  ⇒ 12/95</p> 	
<p>2,5 M00 09B 87 kW (118 PS) VOYAGER VOYAGER TD 01/92-09/95</p>			<p>04-10132-01 </p> 	<p>61-35410-00 4x 98,5 Ø 1,42 mm</p> <p>61-35410-10 4x 98,5 Ø 1,52 mm</p> <p>61-35410-20 4x 98,5 Ø 1,62 mm</p> 							<p>81-35099-00  4x</p> <p>110x130 A SL LD FPM</p> 
<p>2,5 P00 87 kW (118 PS)</p>				<p>61-35385-00 101 Ø</p> 			<p>12-35448-01</p> 	<p>71-35461-00</p> 		<p>81-35444-00  4x</p> <p>45x57</p> <p>81-35456-00  4x</p> <p>76x95</p> 	























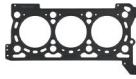
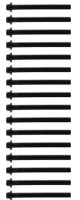
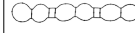



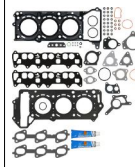
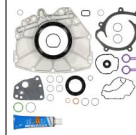

CHRYSLER														
Ltr.														
2,5 VM HR 425 CLJEE	85 kW (116 PS)	VOYAGER	01/92-09/95	01-35484-01 	02-35484-01 				61-35410-00 4x 98,5 Ø 1,42 mm	71-35484-00 			81-25587-10 K↔ 52x68 A SL RD MVQ	
									61-35410-10 4x 98,5 Ø 1,52 mm				81-35478-00 K↔ 110x130 B SL LD FPM	
									61-35410-20 4x 98,5 Ø 1,62 mm 					
2,5 425 CLIRS/X	85 kW (116 PS)	VOYAGER TD	01/95-03/01				04-10148-01		61-35415-00 98 Ø 1,42 mm					
									61-35415-10 98 Ø 1,52 mm					
									61-35415-20 98 Ø 1,62 mm 					
2,7 EER	133-150 kW (181-204 PS)	CONCORDE INTREPID SEBRING SEBRING V6 24V STRATUS VOYAGER 300 C 300 M V6 24V	09/97-11/12	02-10036-01 68003890AD 	08-10231-01 5139553AA 				61-10035-00 R 4792932AC 1,4 mm MLS 	15-10013-01 L 4663713AC +4792213AC (3x) 	12-34783-03 4663904 (24x) 	71-10227-00 L↔ 6x 4663760 	71-10231-00 4792608AC 	81-10390-00 K↔ 4663618 31,5x52 ACM 
									61-10036-00 L 4792931AC 1,4 mm MLS 	15-10015-01 R 4663980AC +4792213AC (3x) 		71-10229-00 L↔ 3x 4663759 		81-10391-00 K↔ 5175829AB PTFE (Polytetrafluorethylen)/ACM (Polyacryl-Kautschuk) 
												71-10369-00 L↔ 2x 4663992 		
2,7 EES	130-149 kW (177-203 PS)	CIRRUS SEBRING V6 24V 300 C 300C	09/00-11/12	02-10036-02 5018593AD 	08-10231-01 5139553AA 				61-10035-00 R 4792932AC 1,4 mm MLS 	15-10013-01 L 4663713AC +4792213AC (3x) 	12-34783-03 4663904 (24x) 	71-10227-00 L↔ 6x 4663760 	71-10231-00 4792608AC 	81-10390-00 K↔ 4663618 31,5x52 ACM 
									61-10036-00 L 4792931AC 1,4 mm MLS 	15-10015-01 R 4663980AC +4792213AC (3x) 		71-10229-00 L↔ 3x 4663759 		81-10391-00 K↔ 5175829AB PTFE (Polytetrafluorethylen)/ACM (Polyacryl-Kautschuk) 
												71-10369-00 L↔ 2x 4663992 		

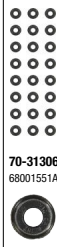

CHRYSLER























Ltr.	ENR	Power (kW/PS)	Model	Year	Part 1	Part 2	Part 3	Part 4	Part 5	Part 6	Part 7	Part 8	Part 9	Part 10	Part 11
2,8	ENR	110 kW (150 PS)	RAM VOYAGER VOYAGER CRD	04/04-07/09	 <b>01-10037-01</b> 				 <b>61-10037-00</b> 1,32 mm MLS   <b>61-10037-10</b> 1,42 mm MLS 1    <b>61-10037-20</b> 1,52 mm MLS 2 	 <b>14-10569-01</b> 	 <b>71-10345-00</b> 5066786AA 	 <b>12-31306-12</b>  16x   <b>70-31306-00</b> 68001551AA	 <b>71-10327-00</b>  5093904AA 	 <b>71-10352-00</b> 	 <b>81-10413-00</b>  PTFE   <b>81-10414-00</b>  120x140 PTFE   <b>81-24459-10</b> <b>N</b> 30x47 A RD FPM   2x
2,8	ENS	120 kW (163 PS)	GRAND VOYAGER GRAND VOYAGER CRD	10/07				 <b>61-10062-00</b> 68031475AA 95 Ø 1,1 mm MLS   <b>61-10062-10</b> 68031476AA 95 Ø 1,2 mm MLS   <b>61-10062-20</b> 68031477AA 95 Ø 1,3 mm MLS		 <b>70-31414-10</b> 	 <b>12-31306-12</b>  16x   <b>70-31306-00</b> 68001551AA	 <b>11-10001-01</b>  68142873AA 07/11 →    <b>71-10330-00</b>  68027586AA 06/11 →    <b>71-10331-00</b>  68027585AA 	 <b>71-10334-00</b> 68027583AA    <b>71-10289-00</b> 	 <b>81-10417-00</b>  PTFE   <b>81-10413-00</b> <b>N</b> PTFE	
2,8	ENS	133 kW (181 PS)	GRAND VOYAGER CRD	09/12				 <b>61-10062-00</b> 68031475AA 95 Ø 1,1 mm MLS   <b>61-10062-10</b> 68031476AA 95 Ø 1,2 mm MLS   <b>61-10062-20</b> 68031477AA 95 Ø 1,3 mm MLS		 <b>70-31414-10</b> 	 <b>12-31306-12</b>  16x   <b>70-31306-00</b> 68001551AA	 <b>11-10001-01</b>  68142873AA    <b>71-10331-00</b>  68027585AA 	 <b>71-10334-00</b> 68027583AA    <b>71-10289-00</b> 	 <b>81-10417-00</b>  PTFE   <b>81-10413-00</b> <b>N</b> PTFE	

CHRYSLER









<p>Ltr.  3,0 EFA</p> <p>100-112 kW (136-152 PS)</p> <p>ACCLAIM LE BARON VOYAGER</p> <p>10/87-03/01 <b>[NEW]</b></p>					<p>61-52693-00 92,5 Ø</p> 		<p>71-52694-00</p> 			<p>70-31414-10</p> 	<p>81-53254-00 <b>K</b>↔</p> <p>37x50 A SL RD MVO</p>  <p>81-10673-00 <b>K</b>↔</p> <p>4621939AB 91x111 AB LD FPM</p> <p>81-21798-30 <b>N</b></p> <p>35x50 A SL WD ACM</p> 
<p>3,0 EXF</p> <p>176 kW (239 PS)</p> <p>300 C CRD</p> <p>09/11</p>					<p>61-10099-00 <b>R</b> 83 Ø 0,96 mm MLS</p> <p>61-10099-10 <b>R</b> 83 Ø 1,06 mm MLS</p> <p>61-10099-20 <b>R</b> 83 Ø 1,16 mm MLS</p> 	<p>14-10863-01</p> 			<p>71-10465-00 <b>L</b>↔ 2x</p>  <p>71-10466-00 <b>L</b>↔ 2x</p> 	<p>70-31414-10</p>  <p>71-10479-00</p> 	<p>81-10410-00 <b>K</b>↔</p> <p>PTFE</p> 
<p>3,0 EXL</p> <p>155 kW (211 PS)</p> <p>300 C CRD</p> <p>11/10-11/12</p>	<p>02-37270-03</p> 	<p>08-37726-04</p> 			<p>61-37270-00 <b>R</b> 68039436AA 84 Ø MLS</p>  <p>61-37275-00 <b>L</b> 68039437AA 84 Ø MLS</p> 		<p>70-31414-10</p> 	<p>12-31306-05 5175438AA (24x)</p>  <p>70-31306-00 68001551AA 24x</p> 	<p>71-37713-00 <b>L</b>↔ 2x 5175645AA</p>  <p>71-37709-00 <b>L</b>↔ 2x 5175748AA</p> 	<p>70-31414-10</p> 	<p>81-26248-10 <b>K</b>↔</p> <p>5073675AB 45x67 A SL RD PTFE</p>  <p>81-10393-00 <b>K</b>↔</p> <p>68238383AA SP LD PTFE</p> 

**CHRYSLER**







Ltr.  3,0 EXL 160 kW (218 PS) 300 C CRD  09/05-11/12  1

										
	02-37270-03 68039436AA 84 Ø MLS	08-37726-01  06/06 68039437AA 84 Ø MLS 08-37726-04  07/06→		61-37270-00 R 68039436AA 84 Ø MLS 61-37275-00 L 68039437AA 84 Ø MLS		70-31414-10 	12-31306-05 5175438AA (24x)	71-37713-00  2x 5175645AA 71-37709-00  2x 5175748AA	70-31414-10 	81-26248-10  K 5073675AB 45x67 A SL RD PTFE 81-90034-00  K 68006028AA  06/06 81-10393-00  K 68238383AA SP LD PTFE  07/06→

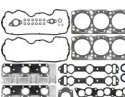



























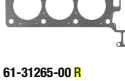

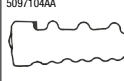
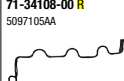

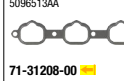



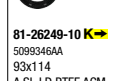





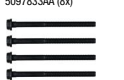
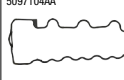
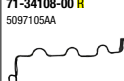

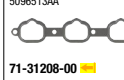



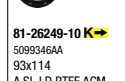



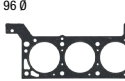

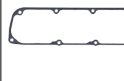

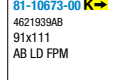

3,0 6G72 105 kW (142-143 PS) LE BARON V6 SARATOGA 09/89-12/96

				61-52693-00 2x 92,5 Ø	14-55063-01 2x 	71-52694-00 2x 	12-52906-02 	71-52962-00  2x 		81-53343-00  K 91x111 A SL LD MVQ 81-53246-00 N 35x50 A SL RD FPM
---	---	--	--	--------------------------	---	---	--	---	--	---

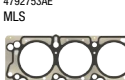
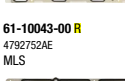

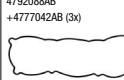











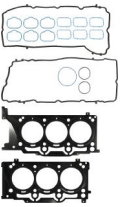









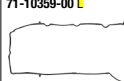

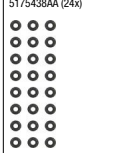









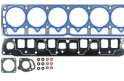
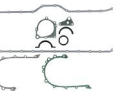
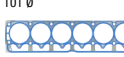
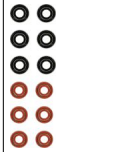









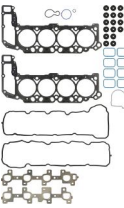
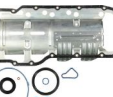
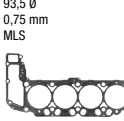

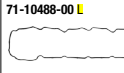





3,0 6G72 108 kW (147 PS) VOYAGER 01/91-09/95

				61-52693-00 2x 92,5 Ø		71-52694-00 2x 	12-52906-02 	71-52962-00  2x 		81-53343-00  K 91x111 A SL LD MVQ 81-53246-00 N 35x50 A SL RD FPM
---	---	--	--	--------------------------	--	---	--	---	--	---

CHRYSLER

<p>Ltr. </p>	<p>3,2 EGX</p>	<p>160 kW (218 PS)</p>	<p>CROSSFIRE</p>	<p>07/03-12/08</p>											
<p>3,2 EGZ</p>	<p>160 kW (218 PS)</p>	<p>CROSSFIRE</p>	<p>07/03-12/08</p>	<p>1</p>		<p><b>02-31260-01 L</b> 5096482AA 92 Ø 0,65 mm MLS</p>  <p><b>02-31265-01 R</b></p> 	<p><b>08-37221-01</b></p> 		<p><b>61-31260-00 L</b> 5096482AA 92 Ø 0,65 mm MLS</p>  <p><b>61-31265-00 R</b> 5096483AA 92 Ø 0,65 mm</p> 	<p><b>14-32106-01</b> 5097833AA (8x)</p> 	<p><b>71-34107-00 L</b> 5097104AA</p>  <p><b>71-34108-00 R</b> 5097105AA</p> 	<p><b>12-29491-03</b> 5086290AA (9x)</p>  <p><b>70-29491-00</b> 5086290AA</p> 	<p><b>71-31363-00 L</b> 5096513AA</p>  <p><b>71-31208-00</b> 5096516AA</p> 	<p><b>70-31414-10</b></p> 	<p><b>81-26248-10 K</b> 5073675AB 45x67 A SL RD PTFE</p>  <p><b>81-26249-10 K</b> 5099346AA 93x114 A SL LD PTFE ACM</p> 
<p>3,3 R00</p>	<p>246 kW (335 PS)</p>	<p>CROSSFIRE SRT-6</p>	<p>09/04-12/07</p>	<p></p>					<p><b>61-31260-00 L</b> 5096482AA 92 Ø 0,65 mm MLS</p>  <p><b>61-31265-00 R</b> 5096483AA 92 Ø 0,65 mm</p> 	<p><b>14-32106-01</b> 5097833AA (8x)</p> 	<p><b>71-34107-00 L</b> 5097104AA</p>  <p><b>71-34108-00 R</b> 5097105AA</p> 	<p><b>12-29491-03</b> 5086290AA (9x)</p>  <p><b>70-29491-00</b> 5086290AA</p> 	<p><b>71-31363-00 L</b> 5096513AA</p>  <p><b>71-31208-00</b> 5096516AA</p> 	<p><b>70-31414-10</b></p> 	<p><b>81-26248-10 K</b> 5073675AB 45x67 A SL RD PTFE</p>  <p><b>81-26249-10 K</b> 5099346AA 93x114 A SL LD PTFE ACM</p> 
<p>3,5 EGG</p>	<p>116-120 kW (158-163 PS)</p>	<p>VOYAGER</p>	<p>08/90-03/01</p>	<p><b>[NEW]</b></p>			<p><b>08-35476-01</b></p> 		<p><b>61-35400-00 R</b> 96 Ø</p>  <p><b>61-35405-00 L</b> 96 Ø</p> 	<p><b>14-10598-01</b></p> 	<p><b>71-35473-00</b></p> 	<p><b>12-35483-02</b> 4201332 (6x)</p> 	<p><b>71-35469-00 L</b></p> 		<p><b>81-35474-00 K</b> 29x41</p>  <p><b>81-10673-00 K</b> 4621939AB 91x111 AB LD FPM</p> 
<p>3,5 EGG</p>	<p>175-187 kW (238-254 PS)</p>	<p>SEBRING 300 C 300 M V6 24V</p>	<p>07/98-11/12</p>	<p></p>					<p><b>61-10042-00 L</b> 4792753AE MLS</p>  <p><b>61-10043-00 R</b> 4792752AE MLS</p> 		<p><b>15-10021-01</b> 4792088AB +4777042AB (3x)</p> 	<p><b>70-10238-00</b> 4892292AA</p> 	<p><b>71-10240-00 L</b> 4663852AB</p> 		

CHRYSLER

<p>Ltr.  3,6 ERB</p> <p>208-224 kW (283-305 PS)</p> <p>GRAND VOYAGER PACIFICA VOYAGER 200 300 C</p> <p>09/10 </p>		 <p>02-10045-01</p> 	 <p>08-26248-01</p> 		 <p>61-10045-00 R</p> <p>97 Ø 0,4 mm MLS</p>  <p>61-10046-00 L</p> <p>97 Ø 0,4 mm MLS</p> 	 <p>14-10415-01</p> 	 <p>71-10358-00 R</p>  <p>71-10359-00 L</p> 	 <p>12-31306-05</p> <p>5175438AA (24x)</p> 	 <p>71-10360-00 </p> <p>6x</p>  <p>71-10413-00 </p> <p>2x</p> 	 <p>70-31414-10</p> 	 <p>81-26248-10 </p> <p>5073675AB 45x67 A SL RD PTFE</p> 
<p>4,0 ERH</p> <p>129-142 kW (175-193 PS)</p>		 <p>02-35390-07</p>	 <p>08-10031-01</p>		 <p>61-35390-00</p> <p>101 Ø</p>		<p>15-35443-01</p>	 <p>12-35448-02</p>	 <p>71-10630-00  </p>	 <p>71-35447-00</p>	 <p>81-35444-10 </p> <p>45x57</p>  <p>81-35446-00 </p> <p>67x82</p> 
<p>4,0 S01</p> <p>130 kW (177 PS)</p>					 <p>61-35390-00</p> <p>101 Ø</p>						
<p>4,7 EVA</p> <p>172 kW (234 PS)</p> <p>ASPEN</p> <p>09/06-12/07</p>		 <p>02-10055-01</p>	 <p>08-10490-01</p>		 <p>61-10055-00</p> <p>93,5 Ø 0,75 mm MLS</p>	 <p>14-10491-02</p>	 <p>71-10487-00 R</p>  <p>71-10488-00 L</p>	 <p>12-10437-02</p>  <p>70-10437-00</p> <p>16x</p> 	 <p>71-10434-00 </p> <p>8x</p>  <p>71-10485-00 </p>  <p>71-10486-00 </p> 	 <p>71-10490-00</p>	 <p>81-10407-00 </p> <p>46x72 FPM</p>  <p>81-10408-00 </p> <p>100x120 FPM</p> 

# Haftungsausschluss

## (für Katalog)

**Alle Angaben in unserem Katalog** wurden von uns sorgfältig geprüft, sind jedoch unverbindlich. Ersatzansprüche wegen Katalogangaben werden von uns nicht anerkannt. Der Käufer ist selbst verpflichtet, zu prüfen, ob unsere Teile für seine Zwecke geeignet sind. In allen Zweifelsfällen sollte Rücksprache mit unserem technischen Kundendienst erfolgen **Tel. +49 731 7046 999**.

**Technische Weiterentwicklungen** oder Änderungen bleiben vorbehalten, soweit damit keine Nachteile für den Kunden verbunden sind.

**Angaben, Namens- und Markenzeichen,** Beschreibungen, Nummern von Fahrzeugnummern und Herstellerzeichen, Original-Ersatzteilnummern der Fahrzeug- und Motorenhersteller u. a. sind ausschließlich für interne Zwecke gedacht. Solche Kennzeichnungen dürfen Fahrzeugbesitzern gegenüber nicht verwendet werden.

**Wir weisen ausdrücklich darauf hin,** dass alle von uns gelieferten Teile von geschultem Fachpersonal einzubauen sind. Reinz haftet für Fehler in diesem Katalog nur, wenn diese für den Kunden nicht offenbar erkennbar sind sowie nur bei Vorsatz und grober Fahrlässigkeit von Reinz, eines Vertreters oder eines Erfüllungsgehilfen. Dieser Haftungsausschluss gilt nicht im Rahmen

des Anwendungsbereichs des Produkthaftungsgesetzes und nicht bei Verletzung von Körper, Leben und Gesundheit, sowie bei der Verletzung von sog. Kardinalpflichten. Darüber hinaus ist unsere Haftung für Schäden, insbesondere für Personen-, Sach- oder Vermögensschäden, die unmittelbar oder mittelbar im Zusammenhang mit der Nutzung dieses Kataloges auftreten, sowie für nicht voraussehbare Schäden ausgeschlossen.

**Reinz ist Inhaber aller Schutzrechte** an den in diesem Katalog gespeicherten Daten. Kopie, Nachdruck, ganze oder teilweise Übernahme der Inhalte und Vervielfältigung, auch auszugsweise, ist nur mit unserer vorheriger schriftlicher Zustimmung sowie mit unserem Urheberrechtsvermerk zulässig.

Für Bestellungen, welche ab dem Erscheinungsdatum eines neuen Katalogs getätigt werden, sind alleine die Angaben des neuen Katalogs maßgeblich. Auf Angaben im Vorkatalog kann bei Neubestellungen nicht mehr zurückgegriffen werden.

**Sofern Sie noch Fragen haben, bitten wir Sie, sich mit uns in Verbindung zu setzen.**

[VictorReinz.com/AGB](http://VictorReinz.com/AGB)

# Exclusion of Liability

## (for catalog)

**All details in our catalog** have been thoroughly checked by us but are however not binding. Right to damages on account of catalog details will not be recognized. The purchaser is obliged to check if our parts are suitable for their use. In all doubtful cases, the purchaser should consult our technical customer service under **+49 731 7046 999**.

**We reserve the right** to further technical developments or changes as long as no disadvantage for the customer results.

**Details, name and trademarks,** descriptions, numbers from vehicle numbers and manufacturer symbols, original vehicle replacement part numbers and engine manufacturer etc. are solely for internal use. Such labels must not be used with vehicle owners.

**We specifically point out** that all parts supplied by us must be assembled by trained specialists.

**Reinz is liable for mistakes** in this catalog only when they are not clearly recognizable for the customer, as well as by intent or gross negligence on the part of Reinz, its representative or vicarious agent. This exclusion of liability does not apply within the framework of the field of

application of the product liability laws and not by bodily harm, life and health, as well as by violation of cardinal duties. In addition, our liability for damages, especially personal, property or financial damages that occur directly or indirectly as a result of the use of this catalog, as well as non-foreseeable damages are excluded.

**Reinz is the owner of all patent rights** on the data stored in this catalog. Copies, reprints, whole or partial takeover of the contents and duplication even in excerpts are only permissible with our prior written approval, as well as with our copyright note.

**For orders placed after the publication date** of a new catalog, only the details in the new catalog are binding and no fall back to details in the previous catalog is possible.

**In case you have further questions, do not hesitate to contact us.**

[VictorReinz.com/AGB](http://VictorReinz.com/AGB)





**VictorReinz.com**

**reinz.info@dana.com**

**Technical Hotline +49 (0)731 7046-9 99**

**REINZ-Dichtungs-GmbH**

Reinzstrasse 3-7  
89233 Neu-Ulm  
Germany  
+49 (0)731 7046-0

***VICTOR REINZ***<sup>®</sup>

---

