

VICTOR REINZ®

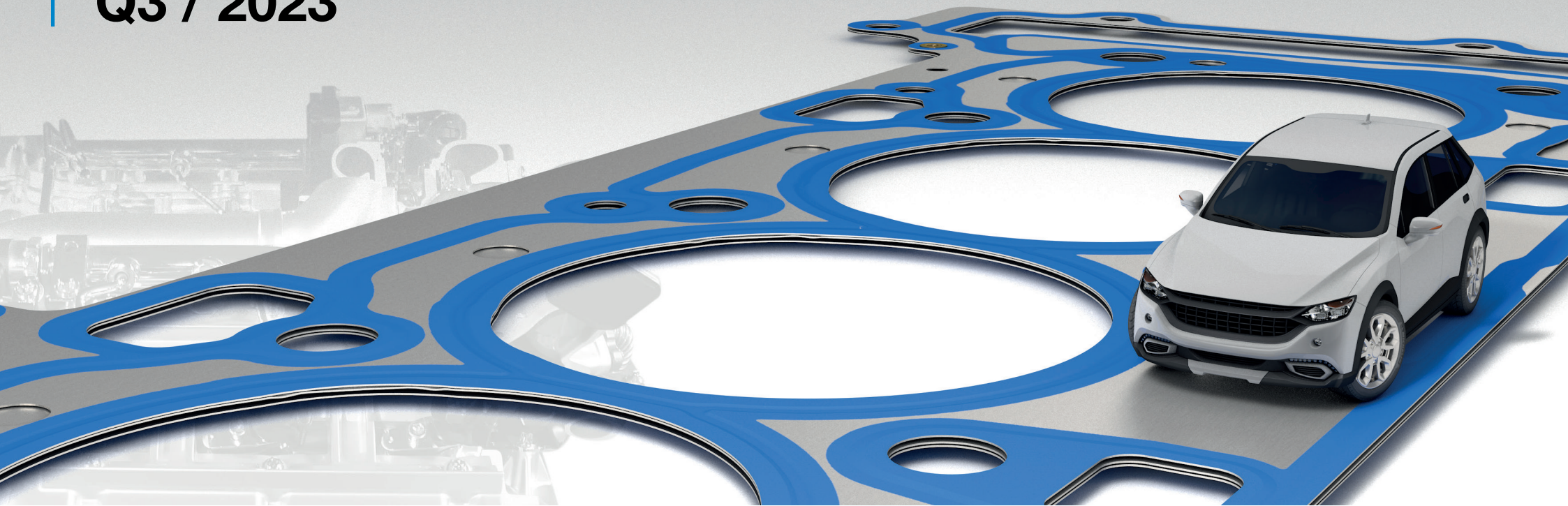

**CITROEN
Q3 / 2023**



VictorReinz.com/online-catalog

Victor Reinz®

at a Glance



Online Catalog

VictorReinz.com/online-catalog



Newsletter

VictorReinz.com/EN/News/Newsletter.aspx?region



Youtube

www.youtube.com/user/VictorReinzSealingEN



Catalog News

VictorReinz.com/news



Technical Service Information

VictorReinz.com/tsi



Facebook

www.facebook.com/VictorReinzParts



Just seal it!

VictorReinz.com/jsi



Technical Datasheet

VictorReinz.com/jsi-datasheet



LinkedIn

www.linkedin.com/showcase/victor-reinz-emea



Safety Datasheet

VictorReinz.com/jsi-datasheet



Homepage

VictorReinz.com

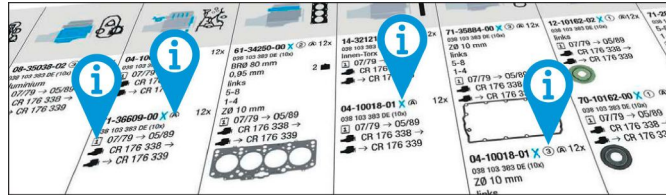

[VictorReinz.com/catalog-info](https://www.victorreinz.com/catalog-info)

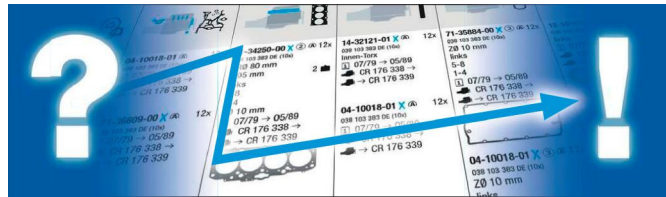

[VictorReinz.com/catalog-how-to-use](https://www.victorreinz.com/catalog-how-to-use)

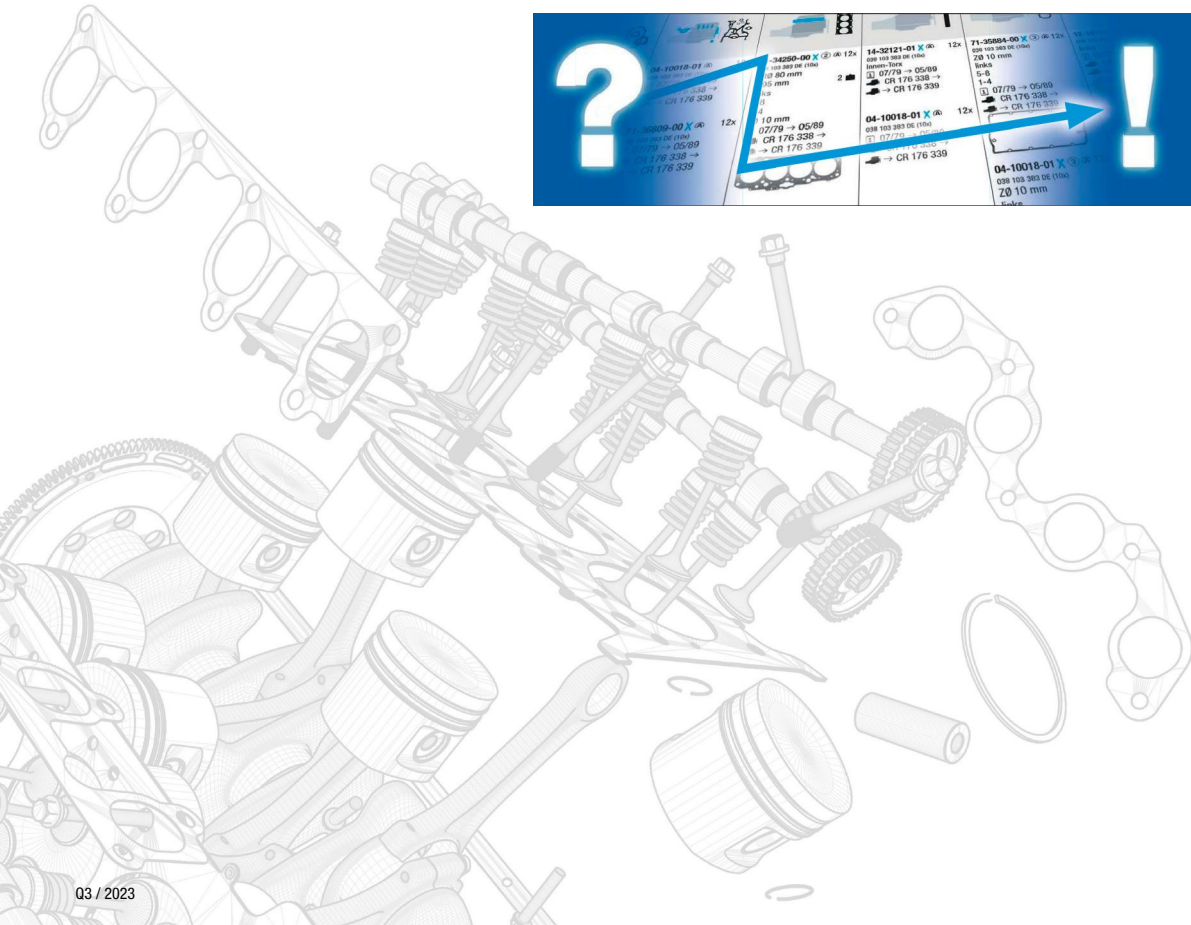

CITROEN



0-9	
108C	8
108C (XV8)	8
109/5	11
109/5E	11
109/5F	11
109K	11
129/5	13
150A	20
150B (XY8)	20
150C	20
150D	20
150D (XY7)	20
150F	20
1580 SPI	34
159A	60
159B	64
161 (XUD7)	49
161A (XUD7)	49
162 (XUD9)	62
169 (XM7T)	52
170A (XN1T)	84
170B (XN1T)	84
170C (XN1T)	84
171A	28
171B	25, 28
171C	28
171D	28
180A (XU5J)	35
180Z	28
180Z (XU5J)	36
220 A2.000	34
3FY (EW12J4)	87
3FZ (EW12J4)	87
4A92	34
4B11	84
4B12	90
4HA (DW12RUE)	86
4HG (P22DTE)	88
4HG (PUMA C)	88
4HH (DW12RUC)	86
4HH (P22DTE)	88
4HH (PUMA C)	88
4HJ (DW12RUD)	86
4HJ (P22DTE)	88



4HJ (PUMA C)	88
4HK (DW12ME5)	88
4HK (DW12RUE)	86
4HL (DW12C)	88
4HN (DW12MTED4)	88
4HP (DW12BTED4)	88
4HR (DW12BTED4)	88
4HS (DW12BTED4)	88
4HT (DW12BTED4)	88
4HU (P22DTE)	88
4HV (P22DTE)	88
4HW (DW12TED4)	89
4HX (DW12TED4)	89
4HY (DW12UTED)	90
4N13	53
5FA (EP6CDT)	36
5FC (EP6CDTM)	37
5FD (EP6DTS)	37
5FE (EP6CDTMD)	37
5FF (EP6DTS)	37
5FK (EP6CB)	37
5FM (EP6CDTM)	37
5FM (EP6DT)	38
5FN (EP6CDT)	37
5FN (EP6DT)	37
5FP (EP6)	37
5FR (EP6DT)	37
5FS (EP6C)	38
5FT (EP6DT)	37
5FU (EP6CDTX)	39
5FU (EP6DTX)	39
5FV (EP6CDT)	37
5FW (EP6)	38
5FX (EP6DT)	37
5FY (EP6CDTX)	39
5GF (EP6FADTXD)	29
5GM (EP6FDTX)	39
5GX (EP6FDTMD)	39
5GY (EP6FTM)	40
5GZ (EP6FDT)	40
6FY (EW7A)	54
6FZ (EW7A)	55
6FZ (EW7J4)	55
8140.43C	95
8140.43N	95



8140.43S	96
8140.63 (F28D)	96
829 A5	84
8FN (EP3)	21
8FP (EP3C)	21
8FR (EP3)	21
8FR (EP3C)	21
8FS (EP3)	21
8HP (DV4C)	21
8HR (DV4C)	21
8HS (DV4TED)	22
8HT (DV4TD)	22
8HX (DV4TD)	15
8HY (DV4TED4)	22
8HZ (DV4TD)	15
9H06 (DV6DTEd)	41
9HC (DV6C)	41
9HD (DV6C)	30, 41
9HE (DV6DBM)	41
9HF (DV6DTEd)	41-42
9HF (DV6DUJ)	41
9HG (DV6C M)	30
9HH (DV6DUM)	41
9HJ (DV6DM)	41
9HJ (DV6DTEdM)	41
9HK (DV6ETEDM)	30
9HL (DV6C)	43
9HM (DV6UC)	41
9HN (DV6ETED)	41
9HP (DV6D)	41
9HP (DV6DTEd)	41
9HR (DV6C)	44
9HS (DV6TED4BU)	45
9HT (DV6BTED4)	29
9HT (DV6BUTED4)	29
9HU (DV6JUTED4)	46
9HV (DV6TED4B)	29
9HV (DV6TED4BU)	29
9HW (DV6BTED4)	47
9HW (DV6ETED)	48
9HX (DV6ATED4)	29
9HX (DV6AUTED4)	29
9HY (DV6TED4)	29
9HZ (DV6TED4)	29



A	
A 53	6
A06/635	6
A06/664	6
A79/1 (AYA2)	6
A8A (XUD7TE)	48
A9A (XUD7)	49
AHE (DW10FD)	64
AHF (DW10FD)	64
AHG (DW10FD)	64
AHH (DW10FC)	64
AHJ (DW10FE)	64
AHK (DW10FE)	64
AHM (DW10FUE)	65
AHN (DW10FUD)	65
AHP (DW10FUC)	65
AHR (DW10FD)	64
AHS (DW10FD)	64
AHU (DW10FCD)	64
AHU (DW10FD)	64
AHV (DW10FCD)	64
AHV (DW10FD)	64
AHW (DW10FC)	64
AHX (DW10FCD)	64
AHX (DW10FD)	64
AHY (DW10CE)	66
AHZ (DW10CD)	66
AJZ (XUD7TE)	48
B	
B1A (XU51C/K)	25
B1E (XU51C)	25, 28
B22/615	86
B25/637	90
B6D	28
B6E	28
BAY (XU5CP)	25
BAZ (XU5CP)	25
BDY (XU5M)	25
BDZ (XU5M)	25
BFZ (XU5JP)	25
BHS (DV6FDU)	26
BHV (DV6DU)	26
BHV (DV6FDU)	27
BHW (DV6FE)	27



BHX (DV6FC)	27
BHX (DV6FCU)	27
BHY (DV6FD)	27
BHZ (DV6FC)	27
BNF (DW12RUD)	86
C	
C1A	6
CDY (TU9M)	6
CDZ (TU9M)	6
CFA (384F)	6
CFB (1KR)	6-7
CRD93L (U25/661)	91
CRD93LS (U25/673)	91
D	
D2A (XU92C)	60
D2C (XU92C)	59-60
D2E	59
D2F	59
D6A (XU9J2)	59-60
D6C (XU9J4)	56
D6E (XU9JA)	61
D6U	59
D8B (XUD9TE)	58
D8B (XUD9TF)	57
D8C (XUD9UTF)	57
D9A (XUD9)	62
D9B (XUD9)	59
D9B (XUD9A/L)	59
D9B (XUD9A/U)	59
DDZ (XU9M)	56
DFW (XU9J4)	56
DFZ (XU9J1)	57
DGY (EP6FADTXHPD)	29
DGZ (EP6FADTXHP)	29
DGZ (EP6FADTXHPD)	29
DHV (XUD9BSD)	57
DHW (XUD9SD)	57
DHX (XUD9BTF)	58
DHX (XUD9TF)	58
DHX (XUD9TF/BTF)	58
DHY (XUD9TE/Y)	57
DJY (XUD9A)	59
DJZ (XUD9A)	59



DKZ (XU9JA)	59
DT17ED4	94
DT20C	96
DV4D	15
DV6B	29
DV6CTED	30
E	
E1A	8
EC5	30
EHS (DW10FDDU370)	64
EHT (DW10FDDU340)	64
EHW (DW10FCD)	64
EHY (DW10FCC)	64
EHZ (DW10FC)	66
EHZ (DW10FDCU)	64
F	
F1AE0481T	90
F1CE0481D (F30DT)	97
F1CE3481E (F30DTE)	97
F28TDCR	95
F30DTE (F1CE3481N)	98
FHY (F13DTE6)	14
FHZ (F13DTE5)	14
G	
G1A	14
H	
H1A	9
H1B	9
HAZ (TU1CP)	9
HDY (TU1M+)	9
HDZ (TU1M)	9-10
HFV (TU1A)	10
HFX (TU1A)	10
HFX (TU1JP)	11
HMM (EB2FAD)	11
HMP (EB2FB)	12
HMR (EB2FA)	11
HMT (EB2D)	12
HMU (EB2D)	12
HMU (EB2FD)	12
HMV (EB2M)	12



HMX (EB2)	12
HMY (EB2M)	12
HMZ (EB2)	12
HMZ (EB2F)	12
HNE (EB2ADTD)	12
HNJ (EB2ADTXM)	12
HNK (EB2ADTD)	12
HNN (EB2ADTX)	12
HNP (EB2ADT)	12
HNS (EB2ADTS)	12
HNV (EB2DTM)	12
HNX (EB2DTSd)	12
HNY (EB2DTS)	12
HNZ (EB2DT)	13
J	
J6T A500	86
K	
K1B	15
K1F	15
K1G	15
K1H (TU3A)	15
K2A	15
K2B	15
K2D	16
K3A	15
K6E (TU3A)	17
K9A (TUD3)	20
K9Y (TUD3Y)	20
KAY (TU3CP)	15
KAZ	16
KAZ (TU3M/Z)	16
KDY (TU3FM)	16
KDY (TU3M)	16
KDZ (TU3M/Z)	16
KFT (TU3A)	17
KFT (TU3AE5)	17
KFU (ET3J4)	17
KFV (TU3A)	18
KFV (TU3JP)	18
KFW (TU3A)	18
KFW (TU3JP)	18
KFX (TU3A)	18
KFX (TU3JP)	18

CITROEN



KFY (TU3FJ2) 19
 KFZ (TU3FJ2/Z) 19

L

LFX (XU7JB) 49
 LFY (XU7JP4) 50
 LFZ (XU7JP) 51-52

M

M25-629 91
 M25-648 91
 M25-659 91
 M25-660 91
 M25-666 91
 M25-669 91
 M28 (AM2) 6
 M28/1 (AK2) 6
 M4 (AM) 6
 M705 62

N

N6A (TU5JP4) 34
 NFP (EC5) 30
 NFP (EC5F) 30
 NFR (TU5JP4B) 31
 NFS (TU5JP4S) 31
 NFT (TU5JP) 32
 NFU (TU5JP4) 32
 NFV (TU5JP) 33
 NFX (TU5J4) 33
 NFZ (TU5JP) 33
 NKZ (4A92) 34

P

P8A (XUD11ATE) 85
 P8C (XUD11BTE) 85
 P9A (XUD11A) 85
 PHZ (XUD11ATE) 85
 PJZ (XUD11ATE) 85

R

R6A 83
 RDZ (XU10MZ) 67
 RFH (EW10A) 67
 RFJ (EW10A) 68



RFK (EW10A) 68
 RFK (EW10J4S) 69
 RFN (EW10J4) 69
 RFR (EW10A) 70
 RFS (XU10J4RS) 70
 RFT (XU10J4/Z) 71
 RFU (XU10J2/C) 71
 RFV (XU10J4R) 72
 RFW (XU10J2U) 73
 RFX (XU10J2C) 73
 RFX (XU10J2C/Z L3) 73
 RFY (XU10J4/Z) 74
 RFZ (XU10J2) 67
 RGX (XU10J2TE) 74
 RGY (XU10J2TE/Z) 74
 RHA (DW10CTED4) 66
 RHC (DW10CTED4) 66
 RHD (DW10CB) 66
 RHD (DW10CTED4) 66
 RHE (DW10CDTR) 66
 RHE (DW10CTED4) 66
 RHF (DW10BTED4) 75
 RHH (DW10CTED4) 66
 RHJ (DW10BTED4) 75
 RHK (DW10UTED4) 76
 RHM (DW10ATED4) 76
 RHR (DW10BTED4) 75
 RHS (DW10ATED) 77
 RHT (DW10ATED4) 76
 RHV (DW10TD) 77
 RHV (DW10UTD) 78
 RHW (DW10ATED4) 76, 78
 RHX (DW10BTED) 79
 RHY (DW10TD) 77
 RHZ (DW10ATED) 77, 79-80
 RHZ (DW10BTED) 81
 RHZ (DW10BTED+) 78
 RHZ (DW10CTED) 82
 RHZ (DW10CTED+) 82
 RLZ (EW10D) 82

S

SFZ (4B12 MMC) 90
 SFZ (ZPJ/Z) 98
 SKZ (ZPJ4/Z) 98



T8A (DJ5T) 94
 T9A (DJ5) 93
 THX (DJ5TED) 92
 THY (DK5ATE) 93
 THZ (DJ5T) 93
 TU3JP4 18
 TU9 6

U

UFZ (ZPJ/Z) 99
 UHZ (DT17BTED4) 94
 UHZ (DT17TED4) 94
 UKZ (ZPJ4/Z) 98

V

VJY (TUD5) 23
 VJZ (TUD5) 23

W

WJX (DW8B) 63
 WJY (DW8B) 63
 WJZ (DW8) 63

X

XFU (ES9A) 99
 XFU (ES9A) 99
 XFX (ES9J4S) 100
 XFX (ES9J4) 101
 XU102C 67
 XU10J2 83
 XU52C 28
 XUD7A 49
 XV8 7























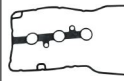































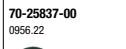
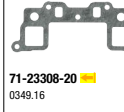
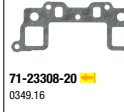





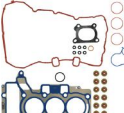





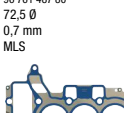

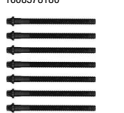

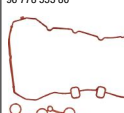

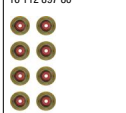
Y

YHR (DV5RUCd) 23
 YHS (DV5RCE) 23
 YHV (DV5RUC) 23
 YHW (DV5RE) 24
 YHX (DV5RC) 23
 YHY (DV5RD) 24
 YHZ (DV5RC) 23



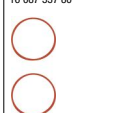
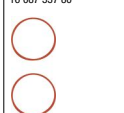

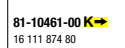









ZMZ (EB0) 7
 ZMZ (EB0F) 7



















































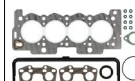









CITROEN

<p>Ltr.  1,0 CFB (1KR) 51 kW (69 PS) C1 04/14 </p>	 01-10200-01 16 132 965 80 	 02-10200-01 16 115 537 80 			 61-10200-00 16 115 414 80 72 Ø 0,5 mm MLS 	 14-32366-01 6822.JC (8x) 	 71-13091-00 16 115 421 80 		 71-12366-00  16 115 508 80  71-12365-00   16 115 508 80  71-12367-00  16 116 090 80 		 81-53508-00  0321.97 38x50 A SL RD FPM/ACM  81-53509-00  16 128 780 80 74x89 A SL LD MVQ 
<p>1,0 XV8 33 kW (45 PS) VISA 09/84-06/88</p>		 02-23307-02 0197.75 	 08-23542-01 0197.76 	 61-23775-20 0209.G8 76 Ø 1,2 mm 16 mm  61-27265-10 0209.A6 76 Ø 1,3 mm 14 mm 		 71-23307-00 0249.39 	 12-25837-01 0956.22 (8x)  70-25837-00 0956.22 	 71-25149-10  0348.54  71-23308-20  0349.16  8x	 71-23542-30 0304.46 	 81-21798-30  0236.14 35x50 A SL WD ACM  81-23708-50  0514.74 85x105 A SL LD FPM 	
<p>1,0 ZMZ (EBO) ZMZ (EBOF) 50 kW (68 PS) C3 08/12</p>		 02-37750-01 	 08-10153-01 	 61-37750-00 96 761 487 80 72,5 Ø 0,7 mm MLS 	 14-10026-01 1608378180 	 15-11549-01 96 778 553 80 	 12-12155-01 16 112 897 80  70-12155-00 12x 	 11-11551-01  16 087 337 80    71-11552-00  96 880 312 80 	 70-31414-10 	 81-41219-00  16 140 859 80 61x75 A SL RD PTFE (Polytetrafluorethylen)/ACM (Polyacryl-Kautschuk)  81-10461-00  16 111 874 80 	

CITROEN

<p>Ltr. </p>	<p>1,0 108C</p>	<p>33 kW (45 PS)</p>	<p>LNA</p>	<p>07/84-10/86</p>												
<p>1,0 108C</p>	<p>33 kW (45 PS)</p>	<p>LNA</p>	<p>07/84-10/86</p>	<p>02-23307-01 0197.74</p>												
<p>1,0 108C (XV8)</p>	<p>33 kW (45 PS)</p>	<p>C15</p>	<p>10/84-12/97</p>													
<p>1,0 108C (XV8)</p>	<p>33 kW (45 PS)</p>	<p>C15</p>	<p>10/84-12/97</p>													
<p>1,1 E1A</p>	<p>35 kW (48 PS)</p>	<p>C15</p>	<p>10/84-12/96</p>													
<p>1,1 E1A</p>	<p>35 kW (48 PS)</p>	<p>C15</p>	<p>10/84-12/96</p>													
<p>1,1 E1A</p>	<p>35 kW (48 PS)</p>	<p>C15</p>	<p>10/84-12/96</p>													
<p>1,1 E1A</p>	<p>35 kW (48 PS)</p>	<p>C15</p>	<p>10/84-12/96</p>													
<p>1,1 E1A</p>	<p>35 kW (48 PS)</p>	<p>C15</p>	<p>10/84-12/96</p>													
<p>1,1 E1A</p>	<p>35 kW (48 PS)</p>	<p>C15</p>	<p>10/84-12/96</p>													
<p>1,1 E1A</p>	<p>35 kW (48 PS)</p>	<p>C15</p>	<p>10/84-12/96</p>													
<p>1,1 E1A</p>	<p>35 kW (48 PS)</p>	<p>C15</p>	<p>10/84-12/96</p>													
<p>1,1 E1A</p>	<p>35 kW (48 PS)</p>	<p>C15</p>	<p>10/84-12/96</p>													
<p>1,1 E1A</p>	<p>35 kW (48 PS)</p>	<p>C15</p>	<p>10/84-12/96</p>													
<p>1,1 E1A</p>	<p>35 kW (48 PS)</p>	<p>C15</p>	<p>10/84-12/96</p>													
<p>1,1 E1A</p>	<p>35 kW (48 PS)</p>	<p>C15</p>	<p>10/84-12/96</p>													
<p>1,1 E1A</p>	<p>35 kW (48 PS)</p>	<p>C15</p>	<p>10/84-12/96</p>													
<p>1,1 E1A</p>	<p>35 kW (48 PS)</p>	<p>C15</p>	<p>10/84-12/96</p>													
<p>1,1 E1A</p>	<p>35 kW (48 PS)</p>	<p>C15</p>	<p>10/84-12/96</p>													
<p>1,1 E1A</p>	<p>35 kW (48 PS)</p>	<p>C15</p>	<p>10/84-12/96</p>													
<p>1,1 E1A</p>	<p>35 kW (48 PS)</p>	<p>C15</p>	<p>10/84-12/96</p>													
<p>1,1 E1A</p>	<p>35 kW (48 PS)</p>	<p>C15</p>	<p>10/84-12/96</p>													
<p>1,1 E1A</p>	<p>35 kW (48 PS)</p>	<p>C15</p>	<p>10/84-12/96</p>													
<p>1,1 E1A</p>	<p>35 kW (48 PS)</p>	<p>C15</p>	<p>10/84-12/96</p>													
<p>1,1 E1A</p>	<p>35 kW (48 PS)</p>	<p>C15</p>	<p>10/84-12/96</p>													
<p>1,1 E1A</p>	<p>35 kW (48 PS)</p>	<p>C15</p>	<p>10/84-12/96</p>													

CITROEN

Ltr. 											
1,1 HAZ (TU1CP) HDY (TU1M+) HDZ (TU1M) H1A H1B	40-44 kW (54-60 PS)	AX 11 BX 11 C15 ZX	09/86	 02-31146-01  0197.H8  02-31200-01  0197.H8 +0209.CJ 	61-33715-00 0209.CJ 76 Ø 1,3 mm 61-33715-10 0209.CK 76 Ø 1,5 mm 	14-32075-01 0204.83 (10x) 	71-31146-00 0249.54 	12-26058-02 0956.19 (8x)  70-26058-00 0956.19 	71-38817-00  2x  71-31147-00  2x 0349.A6  71-31862-00   8x 1709.10 	71-33674-00  	81-31863-00  0514.72 42x66 A SL RD FPM  81-23708-50  0514.74 85x105 A SL LD FPM  81-26244-10  N 0236.21 36x50 A RD ACM 
1,1 HDZ (TU1M)	40 kW (54 PS)	SAXO	05/96-09/03	 02-31146-02  0197.J0  02-31195-01 0197.H8 +0209.89 	61-31195-00 0209.89 73,5 Ø 1,3 mm 	14-32075-01 0204.83 (10x) 	71-31146-00 0249.54 	12-26058-02 0956.19 (8x)  70-26058-00 0956.19 	71-38817-00  2x  71-31147-00  2x 0349.A6  71-31862-00   8x 1709.10 	71-33674-00  	81-31863-00  0514.72 42x66 A SL RD FPM  81-23708-50  0514.74 85x105 A SL LD FPM  81-26244-10  N 0236.21 36x50 A RD ACM 

CITROEN														
Ltr.														
1,1 HDZ (TU1M)	40-44 kW (54-60 PS)	BERLINGO C15 SAXO	08/88-05/08											
				<p>02-31146-02 </p> <p>0197.J0</p>	<p>08-33674-01 </p>	<p>61-33715-00</p> <p>0209.CJ 76 Ø 1,3 mm</p> <p>61-33715-10</p> <p>0209.CK 76 Ø 1,5 mm</p>	<p>14-32075-01</p> <p>0204.83 (10x)</p>	<p>71-31146-00</p> <p>0249.54</p>	<p>12-26058-02</p> <p>0956.19 (8x)</p>	<p>71-38817-00 </p> <p>2x</p>	<p>71-31147-00 </p> <p>2x</p> <p>0349.A6</p>	<p>71-31862-00 </p> <p>8x</p> <p>1709.10</p>	<p>71-33674-00 </p>	<p>81-31863-00 </p> <p>0514.72 42x66 A SL RD FPM</p> <p>81-23708-50 </p> <p>0514.74 85x105 A SL LD FPM</p> <p>81-26244-10 N</p> <p>0236.21 36x50 A RD ACM</p>
1,1 HFV (TU1A) HFV (TU1A)	44 kW (60 PS)	C2 C3	02/02											
				<p>02-35060-02</p>	<p>08-38532-02</p>	<p>61-35060-00</p> <p>0209.Y0 73,5 Ø 1,25 mm</p> <p>61-35060-10</p> <p>0209.Y1 73,5 Ø 1,5 mm</p>	<p>14-32075-01</p> <p>0204.83 (10x)</p>	<p>71-31146-00</p> <p>0249.54</p>	<p>12-26058-02</p> <p>0956.19 (8x)</p>	<p>71-35247-00 </p> <p>0342.E0</p>	<p>71-35068-00 </p> <p>0349.K1</p> <p>8x</p>	<p>70-31414-10</p>	<p>81-38533-00 </p> <p>0514.A3 42x66 A SL RD PTFE (Polytetrafluorethylen)/ACM (Polyacryl-Kautschuk)</p> <p>81-38532-00 </p> <p>0514.A2 85x105 A SL LD PTFE (Polytetrafluorethylen)/ACM (Polyacryl-Kautschuk)</p> <p>81-39633-00 N</p> <p>0807.32 36x50 A SL RD PTFE ACM</p>	































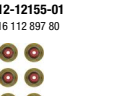

CITROEN

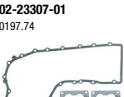
Ltr.	PS	Model	Year	Image 1	Image 2	Image 3	Image 4	Image 5	Image 6	Image 7	Image 8	Image 9	Image 10	Image 11	Image 12
1,1 HFX (TU1JP)	44 kW (60 PS)	BERLINGO C2 C3 SAXO	05/96												
					<p>02-35060-01</p>	<p>08-31859-02</p>		<p>61-35060-00 0209.Y0 73,5 Ø 1,25 mm</p> <p>61-35060-10 0209.Y1 73,5 Ø 1,5 mm</p>	<p>14-32075-01 0204.83 (10x)</p>	<p>71-31146-00 0249.54</p>	<p>12-26058-02 0956.19 (8x)</p> <p>70-26058-00 0956.19</p>	<p>71-35247-00 4x 0342.E0</p> <p>71-33774-00 0349.J6</p> <p>71-35068-00 0349.K1</p> <p>71-36469-00 1709.25</p>	<p>71-33674-00 </p>	<p>81-31863-00 </p> <p>0514.72 42x66 A SL RD FPM</p> <p>81-23708-50 </p> <p>0514.74 85x105 A SL LD FPM</p> <p>81-34403-00 N</p> <p>0236.44 36x50 A SL FPM</p>	
1,1 109K 109/5 109/5E 109/5F	35-42 kW (48-57 PS)	C15 LNA VISA 11	09/78-12/96		<p>02-23307-01 0197.74</p>	<p>08-23542-01 0197.76</p>		<p>61-23775-20 0209.G8 76 Ø 1,2 mm 16 mm</p> <p>61-27265-10 0209.A6 76 Ø 1,3 mm 14 mm</p>		<p>71-23307-00 0249.39</p>	<p>12-25837-01 0956.22 (8x)</p> <p>70-25837-00 0956.22</p>	<p>71-25149-10 0348.54</p> <p>71-23308-20 0349.16</p> <p>8x</p>	<p>71-23542-30 0304.46</p>	<p>81-21798-30 </p> <p>0236.14 35x50 A SL WD ACM</p> <p>81-23578-00 </p> <p>0514.14 78x100 A LD MVQ</p>	
1,2 HMM (EB2FAD) HMR (EB2FA)	50-61 kW (68-83 PS)	C-ELYSEE C3 C3 AIRCROSS	07/16		<p>02-10002-04</p>	<p>08-10155-01</p>		<p>61-10002-00 98 107 491 80 76,3 Ø 0,7 mm MLS</p>	<p>14-10026-01 1608378180</p>	<p>15-11183-01</p>	<p>12-12155-01 16 112 897 80</p>	<p>11-11551-01 16 087 337 80</p> <p>71-11552-00 96 880 312 80</p>	<p>70-31414-10</p>	<p>81-41219-00 </p> <p>16 140 859 80 61x75 A SL RD PTFE (Polytetrafluorethylen)/ACM (Polyacryl-Kautschuk)</p> <p>81-10461-00 </p> <p>16 111 874 80</p>	

CITROEN

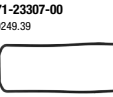





























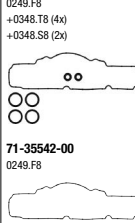





























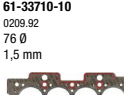

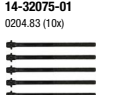



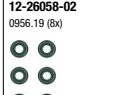







Ltr.														
1.2	HMP (EB2FB) HMT (EB2D) HMU (EB2D) HMU (EB2FD) HMV (EB2M) HMZ (EB2) HMY (EB2M) HMZ (EB2) HMZ (EB2F)	50-66 kW (68-90 PS)	C-ELYSEE C1 C3 C3 AIRCROSS C4 CACTUS DS3	06/12										
					02-37745-01 	08-10461-01 		61-37745-00 96 761 486 80 76,3 Ø 0,7 mm MLS 	14-10026-01 1608378180 	15-11549-01 96 778 553 80 	12-12155-01 16 112 897 80 70-12155-00 12x 	11-11551-01 16 087 337 80 71-11552-00 96 880 312 80 	70-31414-10 	81-41219-00 K 16 140 859 80 61x75 A SL RD PTFE (Polytetrafluorethylen)/ACM (Polyacryl-Kautschuk) 81-10461-00 K 16 111 874 80
1.2	HNE (EB2ADTD) HNJ (EB2ADTXM) HNK (EB2ADTD) HNN (EB2ADTX) HNP (EB2ADT) HNS (EB2ADTS)	74-114 kW (101-155 PS)	BERLINGO C3 C3 AIRCROSS C4 C4 CACTUS C5 AIRCROSS C5 X GRAND C4 SPACETOURER	09/14				61-10813-00 76 Ø MLS 	14-10026-01 1608378180 	70-31414-10 U 71-18240-00 U 	12-12155-01 16 112 897 80 70-12155-00 12x 	71-12156-00 98 039 185 80 71-18242-00 	70-31414-10 	81-41219-00 K 16 140 859 80 61x75 A SL RD PTFE (Polytetrafluorethylen)/ACM (Polyacryl-Kautschuk) 81-10461-00 K 16 111 874 80
1.2	HNV (EB2DTM) HNX (EB2DTSD) HNY (EB2DTS)	81-96 kW (110-131 PS)	C3 C3 AIRCROSS C4 C4 CACTUS C4 GRAND PICASSO C4 PICASSO C4 SPACETOURER DS4 GRAND C4 SPACETOURER	04/14				61-10179-00 98 046 173 80 76 Ø 0,75 mm MLS 	14-10026-01 1608378180 	71-12157-00 98 025 959 80 	12-12155-01 16 112 897 80 70-12155-00 12x 	71-12156-00 98 039 185 80 71-13234-00 98 087 728 80 	70-31414-10 	81-41219-00 K 16 140 859 80 61x75 A SL RD PTFE (Polytetrafluorethylen)/ACM (Polyacryl-Kautschuk) 81-10461-00 K 16 111 874 80

CITROEN

































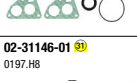







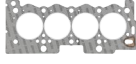























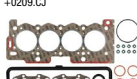



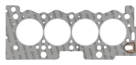





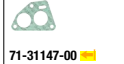



<p>Ltr.  1.2 HNZ (EB2DT) 81 kW (110 PS) BERLINGO C3 C3 AIRCROSS C4 CACTUS C4 PICASSO</p> <p> 10/14</p>											
<p>1.2 HNZ (EB2DT) 81 kW (110 PS) C3 PICASSO C4 C4 CACTUS DS3</p> <p>09/14</p>											
<p>1.2 129/5 47 kW (64 PS) VISA SUPER X</p> <p>07/80-06/82</p>											

CITROEN														
Ltr.														
1,3 FHY (F13DTE6)	59 kW (80 PS)	NEMO HDI 80	10/15		02-36259-04 0197.CJ 	08-36261-05 0197.CH 		61-36210-00 0209.JL 70,5 Ø 0,72 mm MLS 61-36210-10 0209.JC 70,5 Ø 0,82 mm MLS 61-36210-20 0209.JE 70,5 Ø 0,92 mm MLS 	14-32191-01 0250.C6 (10X) 	71-36259-00 0249.G7 	12-31306-12 0956.64 (16X) 70-31306-00 0956.64 16x	71-39538-00 4x 71-36322-00 0349.P2 	70-31414-10 	81-36233-00 0321.A1 40x52 AB SL RD FPM/ACM 81-36232-00 0127.55 78x100 A SL LD PTFE
1,3 FHZ (F13DTE5)	55 kW (75 PS)	NEMO HDI 75	10/10		02-36259-04 0197.CJ 	08-36261-05 0197.CH 	04-10324-02 	61-36210-00 0209.JL 70,5 Ø 0,72 mm MLS 61-36210-10 0209.JC 70,5 Ø 0,82 mm MLS 61-36210-20 0209.JE 70,5 Ø 0,92 mm MLS 	14-32191-01 0250.C6 (10X) 	71-36259-00 0249.G7 	12-31306-12 0956.64 (16X) 70-31306-00 0956.64 16x	71-39538-00 4x 71-36322-00 0349.P2 	70-31414-10 	81-36233-00 0321.A1 40x52 AB SL RD FPM/ACM 81-36232-00 0127.55 78x100 A SL LD PTFE
1,3 G1A	47 kW (64 PS)	C15	07/87-05/88					61-23440-10 0209.JO 78,5 Ø 1,2 mm 		71-12902-00 0249.53 	12-25837-01 0956.22 (8x) 70-25837-00 0956.22 8x 	71-24161-00 0348.80 71-80769-00 0349.E2 	71-21718-00 0304.32 	





















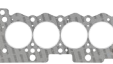























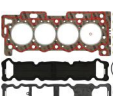



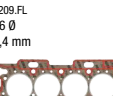

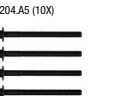





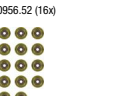







CITROEN

<p>Ltr. </p> <p>1,4 DV4D 8HX (DV4TD) 8HZ (DV4TD)</p> <p>40-55 kW (54-75 PS)</p> <p></p> <p>C2 HDI C3 HDI C3 HDI 70 C3 Pluriel HDI XSARA HDi XSARA HDI</p> <p> 02/02</p>		 <p>02-35542-01</p> 	 <p>08-36869-01</p> 	 <p>04-10081-01 </p> 	 <p>61-35430-00</p> <p>0209.AC 75 Ø 1,25 mm MLS</p> <p>2 </p> <p>61-35430-10</p> <p>0209.AE 75 Ø 1,3 mm MLS</p> <p>3 </p> <p>61-35430-20</p> <p>0209.AF 75 Ø 1,35 mm MLS</p> <p>1 </p> <p>61-35430-30</p> <p>0209.AG 75 Ø 1,4 mm MLS</p> <p>4 </p> <p>61-35430-40</p> <p>0209.AH 75 Ø 1,45 mm MLS</p> <p>5 </p> 	 <p>14-32206-01</p> <p>0204.A2 (10x)</p> 	 <p>15-35542-01</p> <p>0249.F8 +0348.T8 (4x) +0348.S8 (2x)</p>  <p>71-35542-00</p> <p>0249.F8</p> 	 <p>12-35548-01</p> <p>0956.50 (8x)</p>  <p>70-35548-00</p> <p>0956.50</p> 	 <p>40-76246-00 </p> <p>0348.T8</p>  <p>71-35487-00 </p> <p>0349.J8</p> <p>8x </p>	 <p>70-31414-10</p> 	 <p>81-35554-00 </p> <p>0127.42 40x55 A SL RD PTFE ACM</p>  <p>81-35553-00 </p> <p>0127.43 85x105 A SL LD PTFE ACM</p>  <p>81-35552-00 </p> <p>0807.30 27x47 A SL RD PTFE ACM</p> 
<p>1,4 KAY (TU3CP) K1B K1F K1G K1H (TU3A) K2A K2B K3A</p> <p>40-62 kW (55-85 PS)</p> <p>AX AX 14 BX 14 C15</p> <p>04/83</p>		 <p>02-31146-01 </p> <p>0197.H8</p>  <p>02-31200-01 </p> <p>0197.H8 +0209.CJ</p> 	 <p>08-33674-01 </p> 	 <p>61-33710-10</p> <p>0209.92 76 Ø 1,5 mm</p>  <p>61-33715-00</p> <p>0209.CJ 76 Ø 1,3 mm</p> <p>61-33715-10</p> <p>0209.CK 76 Ø 1,5 mm</p> 	 <p>14-32075-01</p> <p>0204.83 (10x)</p> 	 <p>71-31146-00</p> <p>0249.54</p> 	 <p>12-26058-02</p> <p>0956.19 (8x)</p>  <p>70-26058-00</p> <p>0956.19</p> 	 <p>71-38817-00 </p> <p>0514.72 42x66 A SL RD FPM</p> <p>2x </p> <p>71-31147-00 </p> <p>0349.A6</p> <p>8x </p> <p>71-31862-00  </p> <p>1709.10</p> 	 <p>71-33674-00 </p> 	 <p>81-31863-00 </p> <p>0514.72 42x66 A SL RD FPM</p>  <p>81-23708-50 </p> <p>0514.74 85x105 A SL LD FPM</p>  <p>81-26244-10 </p> <p>0236.21 36x50 A RD ACM</p> 	

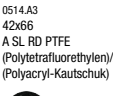















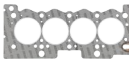













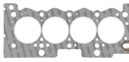

















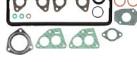



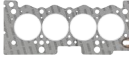









CITROEN

<p>Ltr. </p>											
<p>1,4 KAZ KDX (TU3M/Z) KDY (TU3FM) KDY (TU3M) K2D</p> <p>40-55 kW (54-75 PS)</p> <p>AX 14 BX BX 14 C15 ZX</p> <p>10/82</p>	<p>02-31146-01  0197.H8</p>   <p>02-31146-02  0197.J0</p>   <p>02-31200-01  0197.H8 +0209.CJ</p>   <p>02-33710-01  0197.J0 +0209.A9</p>  	<p>08-31859-01 </p>   <p>08-33674-01 </p>  			<p>61-33710-00 0209.A9 76,3 Ø 1,2 mm</p> <p>61-33710-10 0209.92 76 Ø 1,5 mm</p>  <p>61-33715-00 0209.CJ 76 Ø 1,3 mm</p> <p>61-33715-10 0209.CK 76 Ø 1,5 mm</p> 	<p>14-32075-01 0204.83 (10x)</p> 	<p>71-31146-00 0249.54</p> 	<p>12-26058-02 0956.19 (8x)</p>  <p>70-26058-00 0956.19</p> 	<p>71-38817-00  2x</p>  <p>71-31147-00  2x 0349.A6</p>  <p>71-31862-00   8x 1709.10</p> 	<p>71-33674-00 </p> 	<p>81-31863-00  0514.72 42x66 A SL RD FPM</p>  <p>81-23708-50  0514.74 85x105 A SL LD FPM</p>  <p>81-26244-10  0236.21 36x50 A RD ACM</p> 
<p>1,4 KDZ (TU3M/Z)</p> <p>55-59 kW (75-80 PS)</p> <p>AX GT AX 14 BX 14 ZX</p> <p>04/87-06/97</p>	<p>02-31146-01  0197.H8</p>   <p>02-31200-01  0197.H8 +0209.CJ</p>  	<p>08-33674-01 </p>  			<p>61-33715-00 0209.CJ 76 Ø 1,3 mm</p> <p>61-33715-10 0209.CK 76 Ø 1,5 mm</p> 	<p>14-32075-01 0204.83 (10x)</p> 	<p>71-31146-00 0249.54</p> 	<p>12-26058-02 0956.19 (8x)</p>  <p>70-26058-00 0956.19</p> 	<p>71-38817-00  2x</p>  <p>71-31147-00  2x 0349.A6</p>  <p>71-31862-00   8x 1709.10</p> 	<p>71-33674-00 </p> 	<p>81-31863-00  0514.72 42x66 A SL RD FPM</p>  <p>81-23708-50  0514.74 85x105 A SL LD FPM</p>  <p>81-26244-10  0236.21 36x50 A RD ACM</p> 

















































CITROEN

<p>Ltr. </p> <p>1,4 KFT (TU3A) KFT (TU3AE5) K6E (TU3A)</p> <p>54 kW (73 PS)</p> <p>C3 NEMO</p> <p> 02/08</p>		 <p>02-31146-03</p>  <p>02-33715-02</p> 	 <p>08-38532-02</p> 		 <p>61-33715-00 0209.CJ 76 Ø 1,3 mm</p> <p>61-33715-10 0209.CK 76 Ø 1,5 mm</p> 	 <p>14-32075-01 0204.83 (10x)</p> 	 <p>71-31146-00 0249.54</p> 	 <p>12-26058-02 0956.19 (8x)</p>  <p>70-26058-00 0956.19</p> 	 <p>71-35247-00  4x 0342.E0</p>  <p>71-35068-00  0349.K1</p>  <p>71-42093-00   1709.33</p> 	 <p>70-31414-10</p> 	 <p>81-38533-00  0514.A3 42x66 A SL RD PTFE (Polytetrafluorethylen)/ACM (Polyacryl-Kautschuk)</p>  <p>81-38532-00  0514.A2 85x105 A SL LD PTFE (Polytetrafluorethylen)/ACM (Polyacryl-Kautschuk)</p>  <p>81-39633-00 N 0807.32 36x50 A SL RD PTFE ACM</p> 
<p>1,4 KFU (ET3J4)</p> <p>65 kW (88-90 PS)</p> <p>C2 16V C3 16V C4 16V</p> <p>12/03</p>		 <p>02-36505-01</p> 	 <p>08-38533-01</p> 		 <p>61-36505-00 0209.FL 76 Ø 1,4 mm</p> 	 <p>14-32343-01 0204.A5 (10x)</p> 	 <p>71-36953-00  0249.C5</p>  <p>71-36954-00  0249.C4</p> 	 <p>12-38538-01 0956.52 (16x)</p>  <p>70-38538-00 0956.52</p> 	 <p>11-36956-01  0348.S1</p>  <p>71-35067-00  0349.L3</p>  <p>71-39639-00   1709.29</p> 	 <p>70-31414-10</p> 	 <p>81-38533-00  0514.A3 42x66 A SL RD PTFE (Polytetrafluorethylen)/ACM (Polyacryl-Kautschuk)</p>  <p>81-23708-50  0514.74 85x105 A SL LD FPM</p>  <p>81-39633-00 N 0807.32 36x50 A SL RD PTFE ACM</p>  <p>81-39634-00 N 0807.33 24x50 A SL RD PTFE (Polytetrafluorethylen)/ACM (Polyacryl-Kautschuk)</p> 

















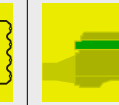
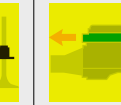
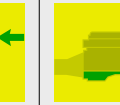











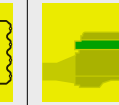
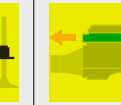
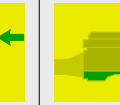

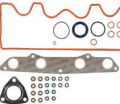

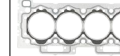
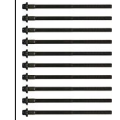
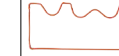
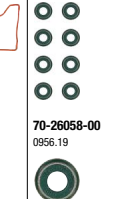







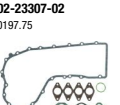









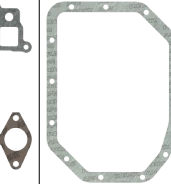





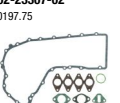

CITROEN

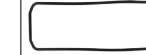
<p>Ltr.  1,4 KfV (TU3A) 54 kW (73 PS) C3  02/02-11/10 </p>					<p>61-33715-00 0209.CJ 76 Ø 1,3 mm</p> <p>61-33715-10 0209.CK 76 Ø 1,5 mm</p> 	<p>14-32075-01 0204.83 (10x)</p> 	<p>71-31146-00 0249.54</p> 	<p>12-26058-02 0956.19 (8x)</p> 	<p>71-35247-00  4x 0342.E0</p>  <p>71-35068-00   0349.K1</p> 	<p>70-31414-10</p> 	<p>81-38533-00  0514.A3 42x66 A SL RD PTFE (Polytetrafluorethylen)/ACM (Polyacryl-Kautschuk)</p>  <p>81-38532-00  0514.A2 85x105 A SL LD PTFE (Polytetrafluorethylen)/ACM (Polyacryl-Kautschuk)</p> 
<p>1,4 KfV (TU3A) 54-58 kW (73-79 PS) C2 C3 C3 Pluriel NEMO 05/03</p>					<p>61-33715-00 0209.CJ 76 Ø 1,3 mm</p> <p>61-33715-10 0209.CK 76 Ø 1,5 mm</p> 	<p>14-32075-01 0204.83 (10x)</p> 	<p>71-31146-00 0249.54</p> 	<p>12-26058-02 0956.19 (8x)</p> 	<p>71-35247-00  4x 0342.E0</p>  <p>71-35068-00  0349.K1</p> 	<p>70-31414-10</p> 	<p>81-38533-00  0514.A3 42x66 A SL RD PTFE (Polytetrafluorethylen)/ACM (Polyacryl-Kautschuk)</p>  <p>81-38532-00  0514.A2 85x105 A SL LD PTFE (Polytetrafluorethylen)/ACM (Polyacryl-Kautschuk)</p> 
<p>1,4 KfV (TU3JP) KfW (TU3A) KfW (TU3JP) KfX (TU3A) KfX (TU3JP) TU3JP4 48-65 kW (65-88 PS) BERLINGO C2 C3 C3 Pluriel SAXO VTS XSARA ZX 03/91</p>	<p>02-31146-01  0197.H8</p>   <p>02-31200-01  0197.H8 +0209.CJ</p>  	<p>08-33674-01 </p>  			<p>61-33715-00 0209.CJ 76 Ø 1,3 mm</p> <p>61-33715-10 0209.CK 76 Ø 1,5 mm</p> 	<p>14-32075-01 0204.83 (10x)</p> 	<p>71-31146-00 0249.54</p> 	<p>12-26058-02 0956.19 (8x)</p> 	<p>71-35247-00  4x 0342.E0</p>  <p>71-31147-00  2x 0349.A6</p>  <p>71-33774-00   0349.J6</p>  <p>71-35068-00   0349.K1</p> 	<p>71-33674-00 </p> 	<p>81-31863-00  0514.72 42x66 A SL RD FPM</p>  <p>81-23708-50  0514.74 85x105 A SL LD FPM</p>  <p>81-26244-10 N 0236.21 36x50 A RD ACM</p> 

















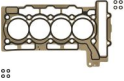
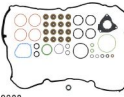





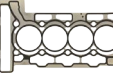



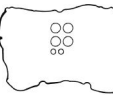

















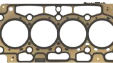



CITROEN

<p>Ltr.  1,4 KFY (TU3FJ2) 66 kW (90 PS) AX 14 GTI  08/91-12/96 </p>		 <p>02-28910-01 0197.J0 +0209.D6</p>   			 <p>61-28910-00 0209.D6 77 Ø 1,2 mm</p> <p>61-28910-10 0209.C1 77 Ø 1,4 mm</p> 	 <p>14-32075-01 0204.83 (10x)</p> 	 <p>71-31146-00 0249.54</p> 	 <p>12-26058-02 0956.19 (8x)</p>  <p>70-26058-00 0956.19</p> 	 <p>71-31147-00  2x 0349.A6</p>  <p>71-31118-00   1710.58</p> 	 <p>70-31414-10</p> 	 <p>81-31863-00  0514.72 42x66 A SL RD FPM</p>  <p>81-23708-50  0514.74 85x105 A SL LD FPM</p>  <p>81-26244-10 N 0236.21 36x50 A RD ACM</p> 
<p>1,4 KFZ (TU3FJ2Z) 69-74 kW (94-100 PS) AX 14 GTI 06/91-12/96</p>		<p>02-28910-01 0197.J0 +0209.D6</p>   			<p>61-28910-00 0209.D6 77 Ø 1,2 mm</p> <p>61-28910-10 0209.C1 77 Ø 1,4 mm</p> 	<p>14-32075-01 0204.83 (10x)</p> 	<p>71-31146-00 0249.54</p> 	<p>12-26058-02 0956.19 (8x)</p>  <p>70-26058-00 0956.19</p> 	<p>71-31147-00  2x 0349.A6</p> 	<p>70-31414-10</p> 	<p>81-31863-00  0514.72 42x66 A SL RD FPM</p>  <p>81-23708-50  0514.74 85x105 A SL LD FPM</p>  <p>81-26244-10 N 0236.21 36x50 A RD ACM</p> 











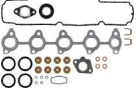





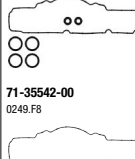
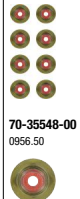













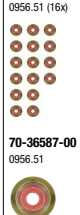

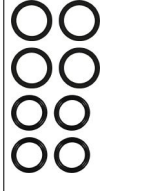

CITROEN

CITROEN															
Ltr. 															
1,4 K9A (TUD3) K9Y (TUD3Y)	37-39 kW (50-53 PS)	AX AX 14 D ZX D	09/88-12/97												
					<p>02-31117-01 0197.K3</p> 	<p>08-31859-01 </p> 		<p>61-31190-00 0209.E9 76 Ø 1,8 mm</p> <p>61-31190-10 0209.N4 76 Ø 1,95 mm MLS</p> 	<p>14-32076-01 0204.84 (10x)</p> 	<p>71-31117-00 0249.76</p> 	<p>12-26058-02 0956.19 (8x)</p> <p>70-26058-00 0956.19</p> <p>8x</p> 	<p>71-31119-00 0349.E4</p> 	<p>70-31414-10</p> 	<p>81-31863-00 </p> <p>0514.72 42x66 A SL RD FPM</p>  <p>81-23708-50 </p> <p>0514.74 85x105 A SL LD FPM</p>  <p>81-26244-00 N</p> <p>0236.16 36x50 A OD NBR</p> 	
1,4 150A 150C 150D 150D (XY7) 150F	44-53 kW (60-72 PS)	BX BX 14 C15 VISA 14	09/82					<p>61-23775-20 0209.G8 76 Ø 1,2 mm 16 mm</p>  <p>61-27265-10 0209.A6 76 Ø 1,3 mm 14 mm</p> 		<p>71-23307-00 0249.39</p> 	<p>12-25837-01 0956.22 (8x)</p> <p>70-25837-00 0956.22</p> <p>8x</p> 	<p>71-25149-10 </p> <p>0348.54</p>  <p>71-23308-20 </p> <p>0349.16</p> 	<p>71-23542-30 0304.46</p> 	<p>81-21798-30 </p> <p>0236.14 35x50 A SL WD ACM</p>  <p>81-23578-00 </p> <p>0514.14 78x100 A LD MVQ</p> 	
1,4 150B (XY8)	55-59 kW (75-80 PS)	BX BX 14 VISA 14 GT	03/82-03/91					<p>61-23775-20 0209.G8 76 Ø 1,2 mm 16 mm</p>  <p>61-27265-10 0209.A6 76 Ø 1,3 mm 14 mm</p> 		<p>71-23307-00 0249.39</p> 	<p>12-25837-01 0956.22 (8x)</p> <p>70-25837-00 0956.22</p> <p>8x</p> 	<p>71-25149-10 </p> <p>0348.54</p>  <p>71-23308-20 </p> <p>0349.16</p> 	<p>70-31414-10</p> 	<p>81-21798-30 </p> <p>0236.14 35x50 A SL WD ACM</p> 	

CITROEN

<p>Ltr. </p> <p>1,4 8FN (EP3) 8FP (EP3C) 8FR (EP3) 8FR (EP3C) 8FS (EP3)</p> <p>70-72 kW (95-98 PS)</p> <p></p> <p>C3 C3 PICASSO C4 VTI DS3</p> <p> 02/09</p>		 <p>02-38005-01</p>   <p>02-38005-02</p>  <p>02-38005-03</p> 			 <p>61-38005-00 0209.EW 78 Ø 0,9 mm MLS</p> <p>61-38005-10  78 Ø 1,2 mm MLS</p> 	 <p>14-32347-01 0204.C1</p> 	 <p>15-37633-01 0249.F4</p> 	 <p>12-37621-01 0956.60</p>  <p>70-37621-00</p> 	 <p>11-37632-01  0348.T4</p>  <p>16x 71-41213-00  1723.CH</p> 	 <p>70-31414-10</p> 	 <p>81-41219-00  16 140 859 80 61x75 A SL RD PTFE (Polytetrafluorethylen)/ACM (Polyacryl-Kautschuk)</p>  <p>81-38532-00  0514.A2 85x105 A SL LD PTFE (Polytetrafluorethylen)/ACM (Polyacryl-Kautschuk)</p> 
<p>1,4 8HP (DV4C) 8HR (DV4C)</p> <p>50 kW (68 PS)</p> <p></p> <p>C3 HDI C3 HDI 70 DS3 HDI 70</p> <p>11/09</p>				<p>04-10340-01 </p> 	<p>61-37945-00 0209.HH 74,7 Ø 1,25 mm MLS</p> <p>61-37945-10 0209.HJ 74,7 Ø 1,3 mm MLS</p> <p>61-37945-20 0209.HK 74,7 Ø 1,35 mm MLS</p> <p>61-37945-30 0209.HL 74,7 Ø 1,4 mm MLS</p> <p>61-37945-40 0209.HN 74,7 Ø 1,45 mm MLS</p> 	<p>14-32336-01 0205.57 (10x)</p> 	<p>71-40903-00 0249.G2</p> 	<p>12-35548-01 0956.50 (8x)</p>  <p>70-35548-00 0956.50</p> 	<p>71-39037-00  98 106 973 80</p> 	<p>70-31414-10</p> 	<p>81-35554-00  0127.42 40x55 A SL RD PTFE ACM</p>  <p>81-35553-00  0127.43 85x105 A SL LD PTFE ACM</p>  <p>81-35552-00  0807.30 27x47 A SL RD PTFE ACM</p> 



CITROEN













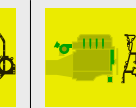

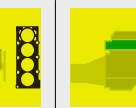

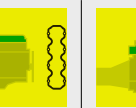
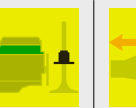
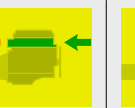

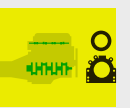





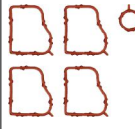



Ltr.	Engine	Power	Model	Year	Part 1	Part 2	Part 3	Part 4	Part 5	Part 6	Part 7	Part 8	Part 9	Part 10	Part 11
1,4	8HS (DV4TED) 8HT (DV4TD)	40-50 kW (54-68 PS)	C1 HDI NEMO HDI	06/05	01-35542-02 0197.AV +0956.50 (8x) 	02-35542-01 		04-10081-01  	61-35430-00 0209.AC 75 Ø 1,25 mm MLS 61-35430-10 0209.AE 75 Ø 1,3 mm MLS 61-35430-20 0209.AF 75 Ø 1,35 mm MLS 61-35430-30 0209.AG 75 Ø 1,4 mm MLS 61-35430-40 0209.AH 75 Ø 1,45 mm MLS 	14-32206-01 0204.A2 (10x) 	15-35542-01 0249.F8 +0348.T8 (4x) +0348.S8 (2x) 	12-35548-01 0956.50 (8x) 	40-76246-00  4x 0348.T8 	70-31414-10 	81-35554-00  0127.42 40x55 A SL RD PTFE ACM  81-35553-00  0127.43 85x105 A SL LD PTFE ACM  81-35552-00 N 0807.30 27x47 A SL RD PTFE ACM 
1,4	8HY (DV4TED4)	66 kW (90 PS)	C3 HDI 16V	02/02	02-36567-01 	08-36869-01 	61-37350-00 0209.AJ 74,7 Ø 1,25 mm MLS 61-37350-10 0209.AK 74,7 Ø 1,3 mm MLS 61-37350-20 0209.AL 74,7 Ø 1,35 mm MLS 61-37350-30 0209.AN 74,7 Ø 1,4 mm MLS 61-37350-40 0209.AP 74,7 Ø 1,45 mm MLS 	14-32206-01 0204.A2 (10x) 	71-36567-00 0249.C2 	12-36587-01 0956.51 (16x) 	11-11022-01  16x 	40-76240-00  4x 0348.R5 	40-76919-00  4x 0348.R4 	71-35487-00  0349.J8 	81-35554-00  0127.42 40x55 A SL RD PTFE ACM  81-35553-00  0127.43 85x105 A SL LD PTFE ACM  81-35552-00 N 0807.30 27x47 A SL RD PTFE ACM 

CITROEN















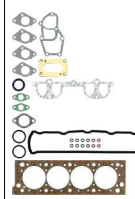
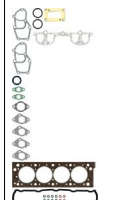
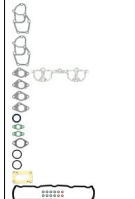







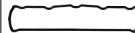

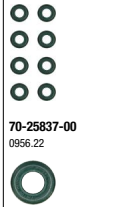















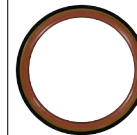

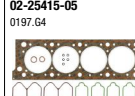
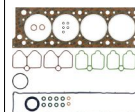







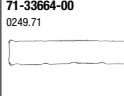

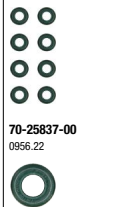









Ltr.	Power	Models	Year	Image 1	Image 2	Image 3	Image 4	Image 5	Image 6	Image 7	Image 8	Image 9	Image 10	Image 11
1,5	VJY (TUD5) VJZ (TUD5)	AX 15 D SAXO D XSARA D ZX D	08/94-04/04											
					02-33645-01 0197.V1 +0209.T8 	08-33659-01 0197.V0 		61-33645-00 0209.T8 78,2 Ø 1,6 mm MLS 	14-32163-01 0204.85 (10x) 	71-33661-00 0249.93 	12-26058-02 0956.19 (8x) 8x 70-26058-00 0956.19 	71-31119-00 0349.E4 	70-31414-10 	81-31863-00 K 0514.72 42x66 A SL RD FPM 81-23708-50 K 0514.74 85x105 A SL LD FPM 81-26244-10 N 0236.21 36x50 A RD ACM
1,5	YHR (DV5RUCd) YHS (DV5RCE) YHV (DV5RUC) YHX (DV5RC) YHZ (DV5RC)	75-96 kW (102-131 PS) BERLINGO HDI 130 C3 AIRCROSS HDI 110 C3 AIRCROSS HDI 120 C4 CACTUS HDI 120 C4 HDI 110 C4 HDI 130 C4 SPACETOURER HDI 130 C5 AIRCROSS HDI 130 GRAND C4 SPACETOURER HDI 130 JUMPY HDI 100 JUMPY HDI 120 SPACETOURER HDI 100 SPACETOURER HDI 120	05/18 [NEW]		02-10750-02 	08-10147-01 	04-10380-01 	61-10750-00 98 244 936 80 76,3 Ø 1,25 mm MLS 61-10750-10 98 244 937 80 76,3 Ø 1,3 mm MLS 61-10750-20 98 244 938 80 76,3 Ø 1,35 mm MLS 61-10750-30 98 244 939 80 76,3 Ø 1,4 mm MLS 61-10750-40 98 244 940 80 76,3 Ø 1,45 mm MLS 	14-32336-01 0205.57 (10x) 	15-11035-01 16 235 002 80 70-31414-10 	12-17500-01 98 100 557 80 (16x) 16x 70-17500-00 98 100 557 80 	71-17331-00 98 137 567 80 71-10654-00 98 162 672 80 	70-31414-10 	81-10552-00 K 98 209 610 80 38x55 A SL RD PTFE 81-38532-00 K 0514.A2 85x105 A SL LD PTFE (Polytetrafluorethylen)/ACM (Polyacryl-Kautschuk) 81-10578-00 N 98 239 200 80 24,7x47 A SL RD PTFE

CITROEN



Ltr.  1,5 YHW (DV5RE) 55-75 kW (75-102 PS) BERLINGO HDI 100 BERLINGO HDI 75 C-ELYSEE HDI 100 C3 AIRCROSS HDI 100 C3 HDI 100 C4 CACTUS HDI 100 05/18 

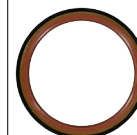























											
	<p>02-10750-02</p> 	<p>08-10147-01</p> 		<p>61-10750-00 98 244 936 80 76,3 Ø 1,25 mm MLS</p> <p>61-10750-10 98 244 937 80 76,3 Ø 1,3 mm MLS</p> <p>61-10750-20 98 244 938 80 76,3 Ø 1,35 mm MLS</p> <p>61-10750-30 98 244 939 80 76,3 Ø 1,4 mm MLS</p> <p>61-10750-40 98 244 940 80 76,3 Ø 1,45 mm MLS</p> 	<p>14-32336-01 0205.57 (10x)</p> 	<p>15-11035-01 </p> <p>16 235 002 80</p>  <p>70-31414-10 </p> 	<p>12-17500-01 98 100 557 80 (16x)</p>  <p>70-17500-00 98 100 557 80</p> 	<p>71-17331-00 </p> <p>98 137 567 80</p>  <p>71-10654-00 </p> <p>98 162 672 80</p> 	<p>70-31414-10</p> 	<p>81-10552-00 </p> <p>98 209 610 80 38x55 A SL RD PTFE</p>  <p>81-38532-00 </p> <p>0514.A2 85x105 A SL LD PTFE (Polytetrafluorethylen)/ACM (Polyacryl-Kautschuk)</p>  <p>81-10578-00 N</p> <p>98 239 200 80 24,7x47 A SL RD PTFE</p> 	

CITROEN













<p>Ltr. </p> <p>1,6 BAY (XU5CP) BAZ (XU5CP) BDY (XU5M) BDZ (XU5M) B1A (XU51C/K) B1E (XU51C) 171B</p> <p>53-70 kW (72-95 PS)</p> <p>BX BX 15 BX 16 ZX</p> <p> 01/87-10/97</p>		 <p>02-25415-03 0197.H6 +0209.E1</p>  <p>02-25415-08 0197.H6 +0209.L3</p>  <p>02-26237-01 0197.H6</p> 	 <p>08-25918-05</p> 		 <p>61-25415-30 0209.E1 84 Ø 1,3 mm</p> <p>61-25415-40 0209.L3 84 Ø 1,5 mm</p> 	 <p>14-32079-01 0204.57 (10x)</p>	 <p>71-26237-00 0249.48</p> 	 <p>12-25837-01 0956.22 (8x)</p>  <p>70-25837-00 0956.22</p> 	 <p>71-31379-10   0349.91</p>  <p>71-26236-10  4x 0349.70</p> <p>8x</p> <p>50-92244-00   1721.01</p> 	 <p>71-25918-30 0304.34</p> 	 <p>81-25926-10  0326.12 42x62 A RD FPM</p>  <p>81-34456-00  0127.28 90x110 A SL LD FPM</p>  <p>81-26244-10 N 0236.21 36x50 A RD ACM</p> 
<p>1,6 BFZ (XU5JP)</p> <p>65-66 kW (88-90 PS)</p> <p>XANTIA ZX</p> <p>03/91-03/01</p>		 <p>02-25415-05 0197.G4</p> 	 <p>08-25918-05</p> 	 <p>61-25415-30 0209.E1 84 Ø 1,3 mm</p> <p>61-25415-40 0209.L3 84 Ø 1,5 mm</p> 	 <p>14-32079-01 0204.57 (10x)  07448</p> <p>14-32078-01 0204.89 (10x)  07449→</p> 	 <p>71-33664-00 0249.71</p> 	 <p>12-25837-01 0956.22 (8x)</p>  <p>70-25837-00 0956.22</p> 	 <p>71-33663-00   2x 0348.F6</p>  <p>71-33738-00   2x 0348.E6</p>  <p>8x</p> <p>71-35364-00   1723.E3</p> 	 <p>71-25918-30 0304.34</p> 	 <p>81-25926-10  0326.12 42x62 A RD FPM</p>  <p>81-34456-00  0127.28 90x110 A SL LD FPM</p>  <p>81-26244-10 N 0236.21 36x50 A RD ACM</p> 	

CITROEN

Ltr.  1,6 BHS (DV6FDU) 70 kW (95 PS) JUMPY HDI 95 SPACETOURER HDI 95 04/16  **[NEW]**

										
			<p>04-10383-01 </p> 	<p>61-10039-00 0209.JN 76 Ø 1,25 mm MLS</p> <p>61-10039-10 0209.JP 76 Ø 1,3 mm MLS</p> <p>61-10039-20 0209.JQ 76 Ø 1,35 mm MLS</p> <p>61-10039-30 0209.JR 76 Ø 1,4 mm MLS</p> <p>61-10039-40 0209.JS 76 Ø 1,45 mm MLS</p> 	<p>14-32336-01 0205.57 (10x)</p> 	<p>71-40903-00 0249.G2</p> 	<p>12-35548-01 0956.50 (8x)</p> <p>70-35548-00 0956.50</p> <p>8x</p> 	<p>71-39037-00 </p> <p>98 106 973 80</p> 	<p>70-31414-10</p> 	<p>81-34454-10 </p> <p>16 089 406 80 40x55 A SL RD PTFE</p>  <p>81-35553-00 </p> <p>0127.43 85x105 A SL LD PTFE ACM</p>  <p>81-35552-00 N</p> <p>0807.30 27x47 A SL RD PTFE ACM</p> 

1,6 BHV (DV6DU) 66 kW (90 PS)

	02-40903-02	08-42514-01	04-10326-01 	<p>61-10039-00 0209.JN 76 Ø 1,25 mm MLS</p> <p>61-10039-10 0209.JP 76 Ø 1,3 mm MLS</p> <p>61-10039-20 0209.JQ 76 Ø 1,35 mm MLS</p> <p>61-10039-30 0209.JR 76 Ø 1,4 mm MLS</p> <p>61-10039-40 0209.JS 76 Ø 1,45 mm MLS</p> 	<p>14-32336-01 0205.57 (10x)</p> 	<p>71-40903-00 0249.G2</p> 	<p>12-35548-01 0956.50 (8x)</p> <p>70-35548-00 0956.50</p> <p>8x</p> 	<p>71-39037-00 </p> <p>98 106 973 80</p> 	<p>70-31414-10</p> 	<p>81-35554-00 </p> <p>0127.42 40x55 A SL RD PTFE ACM</p>  <p>81-35553-00 </p> <p>0127.43 85x105 A SL LD PTFE ACM</p>  <p>81-35552-00 N</p> <p>0807.30 27x47 A SL RD PTFE ACM</p> 
--	--------------------	--------------------	--	--	---	---	---	--	---	--

CITROEN

Ltr.		
1,6	BHV (DV6FDU) BHW (DV6FE) BHX (DV6FC) BHY (DV6FD) BHZ (DV6FC)	04/08 [NEW]
55-88 kW (75-120 PS)	BERLINGO HDI BERLINGO HDI 100 BERLINGO HDI 120 BERLINGO HDI 75 C-ELYSEE HDI C3 AIRCROSS HDI 100 C3 AIRCROSS HDI 115 C3 AIRCROSS HDI 120 C3 HDI C3 HDI 100 C3 HDI 75 C3 PICASSO HDI C4 CACTUS HDI C4 CACTUS HDI 100 C4 GRAND PICASSO HDI C4 GRAND PISCASSO HDI C4 HDI C4 HDI 100 C4 HDI 115 C4 HDI 120 C4 PICASSO HDI C4 PICASSO HDI 100 C4 PISCASSO HDI 120 C4 SPACETOURER HDI 100 C4 SPACETOURER HDI 120 DSS DSS HDI DSS HDI 100 DSS HDI 115 DSS HDI 120 DSS HDI 75 DS4 HDI 120 DS4 HDI 135 DSS HDI DSS HDI 120 GRAND C4 SPACETOURER HDI 100 GRAND C4 SPACETOURER HDI 120 JUMPY HDI 115 JUMPY HDI 95 SPACETOURER HDI 115 SPACETOURER HDI 95	

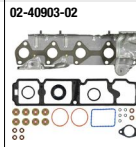
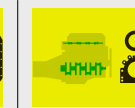
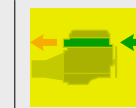

02-40903-02



08-42514-01



04-10383-01



61-10039-00
0209.JN
76 Ø
1,25 mm
MLS

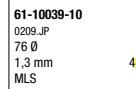

61-10039-10
0209.JP
76 Ø
1,3 mm
MLS

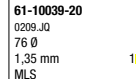

61-10039-20
0209.JQ
76 Ø
1,35 mm
MLS

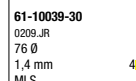

61-10039-30
0209.JR
76 Ø
1,4 mm
MLS



61-10039-40
0209.JS
76 Ø
1,45 mm
MLS

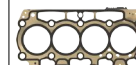

14-32336-01
0205.57 (10x)

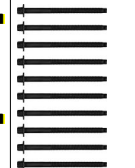

71-40903-00
0249.G2

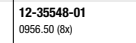

12-35548-01
0956.50 (8x)



70-35548-00
0956.50

8x

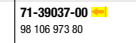

71-39037-00
98 106 973 80



70-31414-10



81-35554-00
0127.42
40x55
A SL RD PTFE ACM

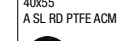

81-35553-00
0127.43
85x105
A SL LD PTFE ACM



81-35552-00
0807.30
27x47
A SL RD PTFE ACM

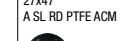

CITROEN

Ltr.	Engine	Power	Model	Year	Part 1	Part 2	Part 3	Part 4	Part 5	Part 6	Part 7	Part 8	Part 9	Part 10	Part 11
1,6	B1E (XU51C) B6D XU52C 171A 171B 171C 171D 180Z	58-85 kW (79-116 PS)	BX BX 16 BX 19 VISA 16 GTI	10/82		<p>02-25415-03 0197.H6 +0209.E1</p> <p>02-25415-08 0197.H6 +0209.L3</p> <p>02-26237-01 0197.H6</p>	<p>08-25918-05</p>	<p>61-25415-30 0209.E1 84 Ø 1,3 mm</p> <p>61-25415-40 0209.L3 84 Ø 1,5 mm</p>	<p>14-32078-01 0204.89 (10x) 1 ⇒ 03/87</p> <p>14-32079-01 0204.57 (10x) 1 ⇒ 04/87 →</p>	<p>71-26237-00 0249.48</p>	<p>12-25837-01 0956.22 (8x)</p> <p>70-25837-00 0956.22</p>	<p>71-31379-10 </p> <p>0349.91</p> <p>71-26236-10 4x</p> <p>0349.70</p> <p>50-92244-00 </p> <p>1721.01</p>	<p>71-25918-30 0304.34</p>	<p>81-25926-10 </p> <p>0326.12 42x62 A RD FPM</p> <p>81-34456-00 </p> <p>0127.28 90x110 A SL LD FPM</p> <p>81-26244-10 N</p> <p>0236.21 36x50 A RD ACM</p>	
1,6	B6E	85 kW (116 PS)	BX	01/87-01/92	<p>15-25415-04 0197.H7 +0209.E1</p>	<p>02-25415-03 0197.H6 +0209.E1</p> <p>02-26237-01 0197.H6</p>	<p>08-25918-05</p>	<p>61-25415-30 0209.E1 84 Ø 1,3 mm</p> <p>61-25415-40 0209.L3 84 Ø 1,5 mm</p>	<p>14-32079-01 0204.57 (10x)</p>	<p>71-26237-00 0249.48</p>	<p>12-25837-01 0956.22 (8x)</p> <p>70-25837-00 0956.22</p>	<p>71-31379-10 </p> <p>0349.91</p> <p>71-26236-10 4x</p> <p>0349.70</p> <p>50-92244-00 </p> <p>1721.01</p>	<p>71-25918-30 0304.34</p>	<p>81-25926-10 </p> <p>0326.12 42x62 A RD FPM</p> <p>81-34456-00 </p> <p>0127.28 90x110 A SL LD FPM</p> <p>81-26244-00 N</p> <p>0236.16 36x50 A OD NBR</p>	













































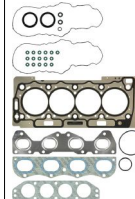

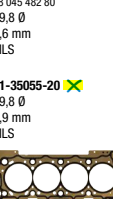

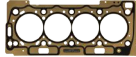

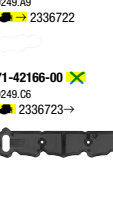













CITROEN

Ltr.														
1,6	DGY (EP6FADTXHP) DGZ (EP6FADTXHP) DGF (EP6FADTXHP) 5GF (EP6FADTXD)	133-165 kW (181-224 PS)	C5 AIRCROSS C5 X GRAND C4 SPACETOURER	04/18				 98 036 733 80 78 Ø 0,9 mm MLS 0209.HP 78 Ø 1,3 mm MLS	 0204.C1	 0249.G9	 0956.60 	 0348.S9 		 16 140 859 80 61x75 A SL RD PTFE (Polytetrafluorethylen)/ACM (Polyacryl-Kautschuk) 0514.A2 85x105 A SL LD PTFE (Polytetrafluorethylen)/ACM (Polyacryl-Kautschuk)
1,6	DV6B 9HT (DV6BTED4) 9HT (DV6BUTED4) 9HV (DV6TED4B) 9HV (DV6TED4BU) 9HX (DV6ATED4) 9HX (DV6AUTE4) 9HY (DV6TED4) 9HZ (DV6TED4)	55-85 kW (75-116 PS)	BERLINGO HDI 110 BERLINGO HDI 75 BERLINGO HDI 90 BERLINGO HDI 90 16V C2 HDI C3 HDI C3 HDI 16V C3 HDI 90 C3 PICASSO HDI C4 HDI C4 HDI 110 FAP C4 HDI 90 C5 HDI C5 HDI 110 XSARA PICASSO HDI	05/04				 0209.CA 76 Ø 1,25 mm MLS 0209.CC 76 Ø 1,3 mm MLS 0209.CE 76 Ø 1,35 mm MLS 0209.CF 76 Ø 1,4 mm MLS 0209.CG 76 Ø 1,45 mm MLS	 0204.A2 (10x) 0249.C2	 0956.S1 (16x) 0956.S1	 0348.R5 0348.R4 0349.J8		 0127.42 40x55 A SL RD PTFE ACM 0127.43 85x105 A SL LD PTFE ACM 0807.30 27x47 A SL RD PTFE ACM	











































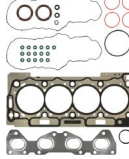
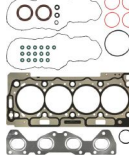



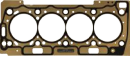







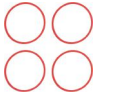

CITROEN

Ltr.														
1,6	DV6CTED 9HD (DV6C) 9HG (DV6C M) 9HK (DV6TEDM)	55-84 kW (75-115 PS)	BERLINGO C3 HDI 115 C3 HDI 75 C3 PICASSO HDI C4 AIRCROSS HDI C4 HDI C4 HDI 115 DS4 HDI 115 DS5 HDI 115	04/10										
					02-40903-02 	08-42514-01 	04-10340-01	61-37940-00 0209.JF 75,7 Ø 1,25 mm MLS 	14-32336-01 0205.57 (10x) 	71-40903-00 0249.G2 	12-35548-01 0956.50 (8x) 	71-39037-00	70-31414-10 	81-35554-00
								61-37940-10 0209.JG 75,7 Ø 1,3 mm MLS 			70-35548-00 0956.50 8x 			81-35553-00
								61-37940-20 0209.JH 75,7 Ø 1,35 mm MLS 						81-35552-00
								61-37940-30 0209.JJ 75,7 Ø 1,4 mm MLS 						81-35551-00
								61-37940-40 0209.JK 75,7 Ø 1,45 mm MLS 						81-35550-00
1,6	EC5 NFP (EC5) NFP (EC5F)	85-90 kW (115-122 PS)	BERLINGO BERLINGO 16V C-ELYSEE C3 C3 PICASSO C4 C4 AIRCROSS C4 CACTUS	07/11		08-38532-02 		61-35055-10 98 045 482 80 79,8 Ø 0,6 mm MLS 	14-32139-04 0204.C4 (10X) 	71-42166-00 0249.C6 2x 	12-33512-02 0956.40 (16x) 	11-35246-01	70-31414-10 	81-38533-00
								61-35055-20			70-33512-00 0956.40 16x 	71-35067-00		81-38532-00
												71-42093-00		81-38531-00
														81-38657-00



















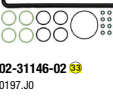

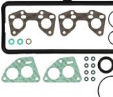







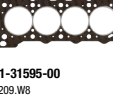





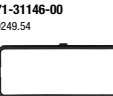

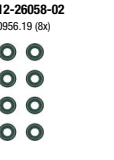
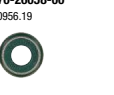



















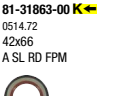













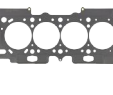
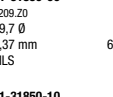

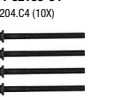



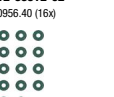

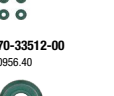
CITROEN

<p>Ltr.  1,6 NFR (TU5JP4B) 66 kW (90 PS) BERLINGO  04/08 </p>					 61-35055-10 98 045 482 80 79,8 Ø 0,6 mm MLS 61-35055-20 79,8 Ø 0,9 mm MLS 	 14-32139-04 0204.C4 (10X) 	 71-42166-00 0249.C6 	 12-33512-02 0956.40 (16x)  70-33512-00 0956.40 	 11-35246-01  0348.05   71-35067-00  0349.L3  71-42093-00   1709.33 	 70-31414-10 	 81-38533-00  0514.A3 42x66 A SL RD PTFE (Polytetrafluorethylen)/ACM (Polyacryl-Kautschuk)  81-38532-00  0514.A2 85x105 A SL LD PTFE (Polytetrafluorethylen)/ACM (Polyacryl-Kautschuk)  81-38531-00  2x 0807.34 38x50 A SL RD PTFE (Polytetrafluorethylen)/ACM (Polyacryl-Kautschuk) 
<p>1,6 NFS (TU5JP4S) 90 kW (122 PS) C2 VTS 10/04-12/09</p>					 61-35055-10 98 045 482 80 79,8 Ø 0,6 mm MLS 61-35055-20  79,8 Ø 0,9 mm MLS 	 14-32139-04 0204.C4 (10X) 	 71-35251-00 0249.A9  2336722  71-42166-00  0249.C6  2336723 → 	 12-33512-02 0956.40 (16x)  70-33512-00 0956.40 	 71-38543-00  0342.J6  71-38544-00  0342.J5  71-35067-00  0349.L3 	 70-31414-10 	 81-38533-00  0514.A3 42x66 A SL RD PTFE (Polytetrafluorethylen)/ACM (Polyacryl-Kautschuk)  81-38532-00  0514.A2 85x105 A SL LD PTFE (Polytetrafluorethylen)/ACM (Polyacryl-Kautschuk)  81-38531-00  2x 0807.34 38x50 A SL RD PTFE (Polytetrafluorethylen)/ACM (Polyacryl-Kautschuk) 

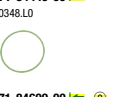
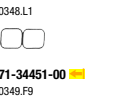
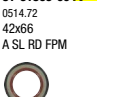

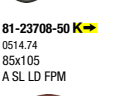

























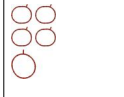









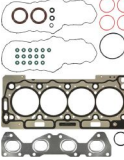





















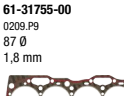

CITROEN

<p>Ltr. </p> <p>1,6 NFT (TU5JP)</p> <p>72-74 kW (98-101 PS)</p> <p>SAXO SAXO VTS</p> <p> 09/00-04/04</p>					 <p>61-31595-00 0209.W8 79,7 Ø 1,37 mm MLS</p> <p>61-31595-10  0209.W9 79,7 Ø 1,57 mm MLS</p> 	 <p>14-32075-01 0204.83 (10x)</p> 	 <p>71-31146-00 0249.54</p> 	 <p>12-26058-02 0956.19 (8x)</p>  <p>70-26058-00 0956.19</p> 	 <p>11-38519-01  0348.P3 (4x)</p>  <p>71-35068-00  0349.K1</p>  <p>71-36469-00   1709.25</p> 	 <p>70-31414-10</p> 	 <p>81-38533-00  0514.A3 42x66 A SL RD PTFE (Polytetrafluorethylen)/ACM (Polyacryl-Kautschuk)</p>  <p>81-38532-00  0514.A2 85x105 A SL LD PTFE (Polytetrafluorethylen)/ACM (Polyacryl-Kautschuk)</p>  <p>81-34403-00 N 0236.44 36x50 A SL FPM</p> 
<p>1,6 NFU (TU5JP4)</p> <p>80-85 kW (109-116 PS)</p> <p>BERLINGO BERLINGO 16V C2 C3 C3 AIRCROSS C3 PICASSO C3 Pluriel C3 16V C4 C4 16V XSARA PICASSO XSARA PICASSO 16V XSARA 16V</p> <p>09/00</p>		<p>02-35055-01</p> 	<p>08-35253-01</p> 	 <p>61-35055-10 98 045 482 80 79,8 Ø 0,6 mm MLS</p> <p>61-35055-20  79,8 Ø 0,9 mm MLS</p> 	<p>14-32139-04 0204.C4 (10x)</p> 	<p>71-35251-00 2x 0249.A9  2336722</p> <p>71-42166-00  2x 0249.O6  2336723→</p> 	<p>12-33512-02 0956.40 (16x)</p>  <p>70-33512-00 16x 0956.40</p> 	<p>11-35246-01  0348.05</p>  <p>71-35067-00  0349.L3</p>  <p>71-36469-00   1709.25</p> 	<p>71-35253-00 0304.55</p> 	<p>81-31863-00  0514.72 42x66 A SL RD FPM</p>  <p>81-23708-50  0514.74 85x105 A SL LD FPM</p>  <p>81-34146-00 N 2x 0807.24 38x50 A SL RD FPM</p> 	

CITROEN

<p>Ltr.  1,6 NFV (TU5JP) NFZ (TU5JP)</p> <p>65-74 kW (88-101 PS)</p> <p>SAXO SAXO VTL_VTR XSARA XSARA PICASSO</p> <p> 02/96-12/10</p>		 <p>02-28980-01 0197.J0 +0209.F6  07874</p>  <p>02-31595-01 0197.J0 +0209.W8  07875→</p>   <p>02-31146-02  0197.J0</p> 	 <p>08-33674-01 </p> 		 <p>61-28980-00 0209.F6 79 Ø 1,5 mm  07874</p> <p>61-28980-10 0209.F7 79 Ø 1,7 mm  07874</p>  <p>61-31595-00 0209.W8 79,7 Ø 1,37 mm MLS  07875→</p> <p>61-31595-10 0209.W9 79,7 Ø 1,57 mm MLS  07875→</p> 	 <p>14-32075-01 0204.83 (10x)</p> 	 <p>71-31146-00 0249.54</p> 	 <p>12-26058-02 0956.19 (8x)</p>  <p>70-26058-00 0956.19</p> 	 <p>11-38519-01  0348.P3 (4x)</p>  <p>71-35249-00  0348.E5  07874</p> <p>8x</p> <p>71-35248-00  0348.P3  07875→</p> <p>4x</p> <p>71-31147-00  0349.A6</p> <p>2x</p>  <p>71-35068-00  0349.K1</p>  <p>71-36469-00   1709.25</p> 	 <p>71-33674-00 </p> 	 <p>81-31863-00  0514.72 42x66 A SL RD FPM</p>  <p>81-23708-50  0514.74 85x105 A SL LD FPM</p>  <p>81-26244-10 N 0236.21 36x50 A RD ACM</p> 
<p>1,6 NFV (TU5J4)</p> <p>80-88 kW (109-120 PS)</p> <p>C3 PICASSO C4 AIRCROSS SAXO SAXO VTS</p> <p>02/96-06/13</p>		 <p>02-31850-01</p> 	 <p>08-33674-01 </p> 	 <p>61-31850-00 0209.Z0 79,7 Ø 1,37 mm MLS </p> <p>61-31850-10 0209.W3 79,7 Ø 1,57 mm MLS </p> <p>61-31850-20 0209.Z1 79,7 Ø 1,77 mm MLS </p> 	 <p>14-32139-04 0204.C4 (10x)</p> 	 <p>70-31414-10</p> 	 <p>12-33512-02 0956.40 (16x)</p>  <p>70-33512-00 0956.40</p> 	 <p>71-34449-00  0348.L0</p>  <p>71-84609-00   0348.L1</p> <p>2x</p> <p>71-34451-00  0349.F9</p> 	 <p>70-31414-10</p> 	 <p>81-31863-00  0514.72 42x66 A SL RD FPM</p>  <p>81-23708-50  0514.74 85x105 A SL LD FPM</p>  <p>81-34146-00 N 0807.24 38x50 A SL RD FPM</p>  <p>2x</p>	

CITROEN

<p>Ltr.  1,6 NKZ (4A92) 4A92</p> <p> 86 kW (117 PS) C4 AIRCROSS</p> <p> 04/12</p>	 <p>01-34240-02 16 076 039 80</p> 				 <p>61-34240-00 16 075 925 80 76 Ø</p> 	 <p>14-10276-01 16 075 990 80 (10x)</p> 	 <p>71-10223-00 16 075 921 80</p> 	 <p>12-10031-01 16 081 662 80 (16x)</p>  <p>70-10031-00 16 081 662 80</p> 	 <p>11-10030-01  16 075 918 80 (4x)</p>  <p>71-10222-00  16 075 911 80</p> 	 <p>70-31414-10</p> 	 <p>81-39028-00  16 075 932 80 29x48 A RD</p>  <p>81-10389-00  16 078 540 80 LD FPM</p> 
<p>1,6 N6A (TU5JP4) 83 kW (113 PS) C4</p> <p>09/09-12/14</p>		<p>02-35055-01</p> 	<p>08-35253-01</p> 		<p>61-35055-10 98 045 482 80 79,8 Ø 0,6 mm MLS</p> <p>61-35055-20  79,8 Ø 0,9 mm MLS</p> 	<p>14-32139-04 0204.C4 (10x)</p> 	<p>71-35251-00 2x 0249.A9</p> 	<p>12-33512-02 0956.40 (16x)</p>  <p>70-33512-00 16x 0956.40</p> 	<p>11-35246-01  0348.05</p>  <p>71-35067-00  0349.L3</p>  <p>71-36469-00  16 1709.25</p> 	<p>71-35253-00 0304.55</p> 	<p>81-31863-00  0514.72 42x66 A SL RD FPM</p>  <p>81-23708-50  0514.74 85x105 A SL LD FPM</p>  <p>81-34146-00 N 2x 0807.24 30x50 A SL RD FPM</p> 
<p>1,6 1580 SPI 58 kW (79 PS) JUMPY</p> <p>10/95-08/00</p>	<p>01-31755-03</p> 	<p>02-31755-06 0197.V3</p> 		<p>61-31755-00 0209.P9 87 Ø 1,8 mm</p> 		<p>71-31729-00  71-31732-00 U</p> 	<p>12-25837-01 0956.22 (8x)</p>  <p>70-25837-00 8x 0956.22</p> 	<p>71-35716-00   2x</p> 	<p>71-31742-00 0304.49</p> 	<p>81-35883-00 N 30x52 AB SL RD FPM</p> 	

CITROEN

Ltr.  1.6 180A (XU5J) 76 kW (103 PS)  VISA 16 GTI  01/85-06/86

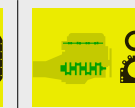
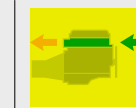

02-25415-03
0197.H6
+0209.E1

02-25415-08
0197.H6
+0209.L3

02-26237-01
0197.H6

08-25918-05

61-25415-30
0209.E1
84 Ø
1,3 mm



61-25415-40
0209.L3
84 Ø
1,5 mm

14-32078-01
0204.89 (10x)



71-26237-00
0249.48

12-25837-01
0956.22 (8x)

70-25837-00
0956.22

71-31379-10  
0349.91

71-26236-10  4x
0349.70

71-27178-10  
1710.39

71-25918-30
0304.34

81-25826-10 
0326.12
42x62
A RD FPM

81-34456-00 
0127.28
90x110
A SL LD FPM

CITROEN

Ltr. 180Z (XU5J) 76 kW (103 PS) BX 16 03/86-12/94

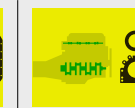
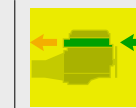

02-25415-03
0197.H6
+0209.E1

02-25415-08
0197.H6
+0209.L3

02-26237-01
0197.H6

08-25918-05

61-25415-30
0209.E1
84 Ø
1,3 mm

61-25415-40
0209.L3
84 Ø
1,5 mm

14-32078-01
0204.89 (10x)

14-32079-01
0204.57 (10x)

71-26237-00
0249.48

12-25837-01
0956.22 (8x)

70-25837-00
0956.22

71-31379-10
0349.91

71-26236-10 4x
0349.70

71-27178-10
1710.39

71-25918-30
0304.34

81-25926-10
0326.12
42x62
A RD FPM

81-34456-00
0127.28
90x110
A SL LD FPM

1,6 5FA (EP6CDT) 92 kW (125 PS)

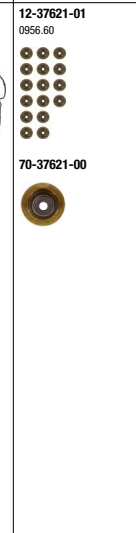
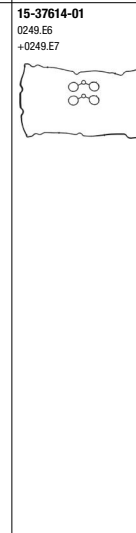
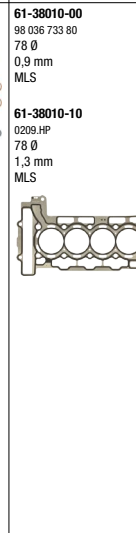
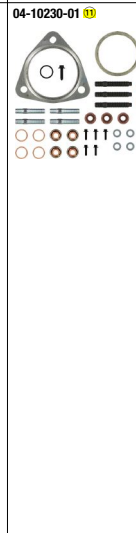

04-10230-01

61-38010-00
98 036 733 80
78 Ø
0,9 mm
MLS

61-38010-10
0209.HP
78 Ø
1,3 mm
MLS

14-32347-01
0204.C1

15-37614-01
0249.E6
+0249.E7

12-37621-01
0956.60

70-37621-00

11-37616-01
0348.S9

71-12290-00
96 781 882 80













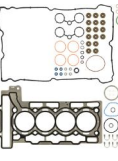







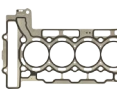



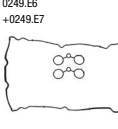

















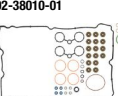
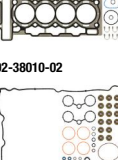



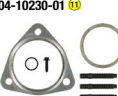



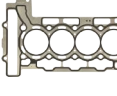

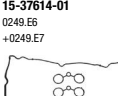



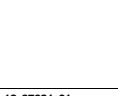





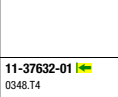



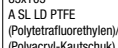

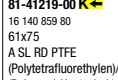

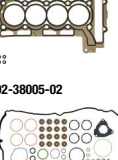









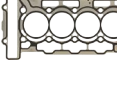

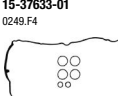





70-31414-10

81-41219-00
16 140 859 80
61x75
A SL RD PTFE
(Polytetrafluorethylen)/ACM
(Polyacryl-Kautschuk)





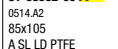









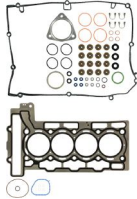



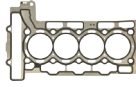

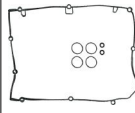
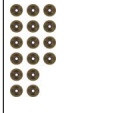

















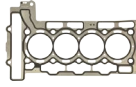

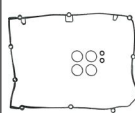
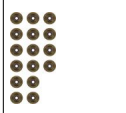















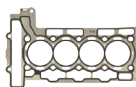

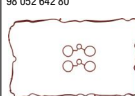

81-38532-00
0514.A2
85x105
A SL LD PTFE
(Polytetrafluorethylen)/ACM
(Polyacryl-Kautschuk)

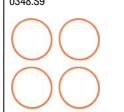
CITROEN														
1,6	5FC (EP6CDTM) 5FE (EP6CDTMD) 5FM (EP6CDTM)	110-121 kW (150-165 PS)	C4 DS4 DS5	04/11										
Ltr.					02-38010-01 		04-10230-01	61-38010-00 98 036 733 80 78 Ø 0,9 mm MLS 61-38010-10 0209.HP 78 Ø 1,3 mm MLS 	14-32347-01 0204.C1 	15-37614-01 0249.E6 +0249.E7 	12-37621-01 0956.60 	11-37616-01	70-31414-10 	81-41219-00 16 140 859 80 61x75 A SL RD PTFE (Polytetrafluorethylen)/ACM (Polyacryl-Kautschuk) 81-38532-00 0514.A2 85x105 A SL LD PTFE (Polytetrafluorethylen)/ACM (Polyacryl-Kautschuk)
1,6	5FD (EP6DTS) 5FF (EP6DTS) 5FN (EP6CDT) 5FN (EP6DT) 5FR (EP6DT) 5FT (EP6DT) 5FV (EP6CDT) 5FX (EP6DT)	103-152 kW (140-207 PS)	C4 C4 Grand PICASSO C4 GRAND PICASSO C4 GRAND PICASSO 16V C4 PICASSO C4 PICASSO 16V C4 THP C4 16V C5 DS3 DS3 HDI 90 DS4 DS5	06/08										
					02-38010-01 		04-10230-01	61-38010-00 98 036 733 80 78 Ø 0,9 mm MLS 61-38010-10	14-32347-01 0204.C1 	15-37614-01 0249.E6 +0249.E7 	12-37621-01 0956.60 	11-37616-01	70-31414-10 	81-41219-00 16 140 859 80 61x75 A SL RD PTFE (Polytetrafluorethylen)/ACM (Polyacryl-Kautschuk) 81-38532-00 0514.A2 85x105 A SL LD PTFE (Polytetrafluorethylen)/ACM (Polyacryl-Kautschuk)
1,6	5FK (EP6CB) 5FP (EP6)	72-84 kW (98-114 PS)	BERLINGO C3	07/09										
					02-38005-01 	08-11542-01 		61-38005-00 0209.EW 78 Ø 0,9 mm MLS 61-38005-10 78 Ø 1,2 mm MLS 	14-32347-01 0204.C1 	15-37633-01 0249.F4 	12-37621-01 0956.60 	11-37632-01	70-31414-10 	81-41219-00 16 140 859 80 61x75 A SL RD PTFE (Polytetrafluorethylen)/ACM (Polyacryl-Kautschuk) 81-38532-00 0514.A2 85x105 A SL LD PTFE (Polytetrafluorethylen)/ACM (Polyacryl-Kautschuk)





















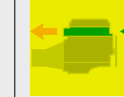







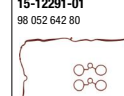
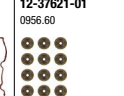



CITROEN

<p>Ltr.  1,6 5FM (EP6DT) 120 kW (163 PS) C5 DS3 03/11</p>		 <p>02-38010-01</p>  <p>02-38010-02</p> 	 <p>08-11542-01</p> 	 <p>04-10230-01 </p> 	 <p>61-38010-00 98 036 733 80 78 Ø 0,9 mm MLS</p> <p>61-38010-10 0209.HP 78 Ø 1,3 mm MLS</p> 	 <p>14-32347-01 0204.C1</p> 	 <p>15-37614-01 0249.E6 +0249.E7</p> 	 <p>12-37621-01 0956.60</p>  <p>70-37621-00</p> 	 <p>11-37616-01 </p> <p>0348.S9</p>  <p>16x 71-41214-00  </p> <p>V7 616 895 80</p> 	 <p>70-31414-10</p> 	 <p>81-41219-00 </p> <p>16 140 859 80 61x75 A SL RD PTFE (Polytetrafluorethylen)/ACM (Polyacryl-Kautschuk)</p>  <p>81-38532-00 </p> <p>0514.A2 85x105 A SL LD PTFE (Polytetrafluorethylen)/ACM (Polyacryl-Kautschuk)</p> 
<p>1,6 5FM (EP6DT) 121 kW (165 PS) DS5 01/12-07/15</p>		 <p>02-38010-01</p>  <p>02-38010-02</p> 	 <p>08-11542-01</p> 	 <p>04-10230-01 </p> 	 <p>61-38010-00 98 036 733 80 78 Ø 0,9 mm MLS</p> <p>61-38010-10 </p> <p>0209.HP 78 Ø 1,3 mm MLS</p> 	 <p>14-32347-01 0204.C1</p> 	 <p>15-37614-01 0249.E6 +0249.E7</p> 	 <p>12-37621-01 0956.60</p>  <p>70-37621-00</p> 	 <p>11-37616-01 </p> <p>0348.S9</p>  <p>16x 71-41214-00  </p> <p>V7 616 895 80</p> 	 <p>70-31414-10</p> 	 <p>81-41219-00 </p> <p>16 140 859 80 61x75 A SL RD PTFE (Polytetrafluorethylen)/ACM (Polyacryl-Kautschuk)</p>  <p>81-38532-00 </p> <p>0514.A2 85x105 A SL LD PTFE (Polytetrafluorethylen)/ACM (Polyacryl-Kautschuk)</p> 
<p>1,6 5FS (EP6C) 5FW (EP6) 88 kW (120 PS) BERLINGO C3 C3 PICASSO C4 C4 GRAND PICASSO C4 PICASSO C4 VTI C5 DS3 DS4 07/08</p>		 <p>02-38005-01</p>  <p>02-38005-02</p>  <p>02-38005-03</p> 	 <p>08-11542-01</p> 	 <p>04-10230-01 </p> 	 <p>61-38005-00 0209.EW 78 Ø 0,9 mm MLS</p> <p>61-38005-10 </p> <p>78 Ø 1,2 mm MLS</p> 	 <p>14-32347-01 0204.C1</p> 	 <p>15-37633-01 0249.F4</p> 	 <p>12-37621-01 0956.60</p>  <p>70-37621-00</p> 	 <p>11-37632-01 </p> <p>0348.T4</p>  <p>16x 71-41213-00  </p> <p>1723.CH</p> 	 <p>70-31414-10</p> 	 <p>81-41219-00 </p> <p>16 140 859 80 61x75 A SL RD PTFE (Polytetrafluorethylen)/ACM (Polyacryl-Kautschuk)</p>  <p>81-38532-00 </p> <p>0514.A2 85x105 A SL LD PTFE (Polytetrafluorethylen)/ACM (Polyacryl-Kautschuk)</p> 

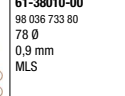
CITROEN

<p>Ltr.  1,6 5FU (EP6CDTX) 147 kW (200 PS) DS4 DS5 04/11</p> <p></p> <p></p>		<p>02-11519-01</p>  <p>02-38010-03</p> 	<p>08-11542-01</p> 	<p>04-10230-01 </p> 	<p>61-38010-00 98 036 733 80 78 Ø 0,9 mm MLS</p> <p>61-38010-10 </p> <p>0209.HP 78 Ø 1,3 mm MLS</p> 	<p>14-32347-01 0204.C1</p> 	<p>15-11519-01 0249.G9</p> 	<p>12-37621-01 0956.60</p>  <p>70-37621-00</p> 	<p>11-37616-01 </p> <p>0348.S9</p>  <p>16x 71-41214-00  </p> <p>V7 616 895 80</p>  <p>71-11545-00  </p> <p>1709.45</p> 	<p>70-31414-10</p> 	<p>81-41219-00 </p> <p>16 140 859 80 61x75 A SL RD PTFE (Polytetrafluorethylen)/ACM (Polyacryl-Kautschuk)</p>  <p>81-38532-00 </p> <p>0514.A2 85x105 A SL LD PTFE (Polytetrafluorethylen)/ACM (Polyacryl-Kautschuk)</p> 
<p>1,6 5GM (EP6FDTX) 155 kW (211 PS)</p>		<p>02-38010-08</p>  	<p>08-10148-01</p> 		<p>61-38010-00 98 036 733 80 78 Ø 0,9 mm MLS</p> <p>61-38010-10 </p> <p>0209.HP 78 Ø 1,3 mm MLS</p> 	<p>14-32347-01 0204.C1</p> 	<p>15-11519-01 0249.G9</p> 	<p>12-37621-01 0956.60</p>  <p>70-37621-00</p> 	<p>11-37616-01 </p> <p>0348.S9</p>  <p>16x 71-12290-00 </p> <p>96 781 882 80</p> 	<p>70-31414-10</p> 	<p>81-41219-00 </p> <p>16 140 859 80 61x75 A SL RD PTFE (Polytetrafluorethylen)/ACM (Polyacryl-Kautschuk)</p>  <p>81-38532-00 </p> <p>0514.A2 85x105 A SL LD PTFE (Polytetrafluorethylen)/ACM (Polyacryl-Kautschuk)</p> 
<p>1,6 5GX (EP6FDMT) 110 kW (150 PS) C5 AIRCROSS GRAND C4 SPACETOUREUR 04/18</p>		<p>02-38010-06</p>  	<p>08-10148-01</p> 	<p>04-10230-01 </p> 	<p>61-38010-00 98 036 733 80 78 Ø 0,9 mm MLS</p> <p>61-38010-10 0209.HP 78 Ø 1,3 mm MLS</p> 	<p>14-32347-01 0204.C1</p> 	<p>15-12291-01 98 052 642 80</p> 	<p>12-37621-01 0956.60</p>  <p>70-37621-00</p> 	<p>11-37616-01 </p> <p>0348.S9</p>  <p>16x 71-12290-00 </p> <p>96 781 882 80</p> 	<p>70-31414-10</p> 	<p>81-41219-00 </p> <p>16 140 859 80 61x75 A SL RD PTFE (Polytetrafluorethylen)/ACM (Polyacryl-Kautschuk)</p>  <p>81-38532-00 </p> <p>0514.A2 85x105 A SL LD PTFE (Polytetrafluorethylen)/ACM (Polyacryl-Kautschuk)</p> 

CITROEN





















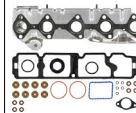





<p>Ltr.  1,6 5GY (EP6FDTM) 121-127 kW (165-173 PS) C4 C4 CACTUS C5 AIRCROSS 08/13 </p>											
<p>1,6 5GZ (EP6FDT) 121 kW (165 PS) C4 GRAND PICASSO II 07/14</p>											
<p>1,6 5GZ (EP6FDT) 121 kW (165 PS) C4 PICASSO II C4 SPACETOURER DS3 DS4 DS5 GRAND C4 SPACETOURER 01/12</p>											

CITROEN



Ltr.	Icon	Power	Model	Year	Image 1	Image 2	Image 3	Image 4	Image 5	Image 6	Image 7	Image 8	Image 9	Image 10	Image 11
1,6		55-85 kW (75-116 PS)	BERLINGO HDI 100 BERLINGO HDI 75 BERLINGO HDI 90 BERLINGO HDI 92 C-ELYSEE HDI 92 C3 AIRCROSS HDI 92 C3 HDI C3 HDI 90 C3 HDI 92 C3 PICASSO HDI 90 C4 CACTUS HDI 90 C4 GRAND PICASSO HDI C4 HDI C4 HDI 90 C4 PICASSO C4 PICASSO HDI C4 SPACETOURER HDI 115 DS3 HDI 115 DS3 HDI 90 DS4 HDI 90 GRAND C4 SPACETOURER HDI 115 JUMPY HDI 90 JUMPY HDI 90 8V SPACETOURER HDI 90	01/07											
					02-40903-02	08-42514-01	04-10340-01	61-10039-00 0209.JN 76 Ø 1,25 mm MLS 61-10039-10 0209.JP 76 Ø 1,3 mm MLS 61-10039-20 0209.JQ 76 Ø 1,35 mm MLS 61-10039-30 0209.JR 76 Ø 1,4 mm MLS 61-10039-40 0209.JS 76 Ø 1,45 mm MLS	14-32336-01 0205.57 (10x)	71-40903-00 0249.G2	12-35548-01 0956.50 (8x)	71-39037-00 98 106 973 80	70-31414-10 	81-35554-00 0127.42 40x55 A SL RD PTFE ACM 81-35553-00 0127.43 85x105 A SL LD PTFE ACM 81-35552-00 0807.30 27x47 A SL RD PTFE ACM	
1,6		84 kW (114 PS)	DS3 HDI 115	08/12-07/15			04-10340-01	61-37940-40 0209.JK 75,7 Ø 1,45 mm MLS 12999 61-37940-00 0209.JF 75,7 Ø 1,25 mm MLS 61-37940-10 0209.JG 75,7 Ø 1,3 mm MLS 61-37940-20 0209.JH 75,7 Ø 1,35 mm MLS 61-37940-30 0209.JJ 75,7 Ø 1,4 mm MLS	14-32336-01 0205.57 (10x)	71-40903-00 0249.G2	12-35548-01 0956.50 (8x)	71-39037-00 98 106 973 80	70-31414-10 	81-35554-00 0127.42 40x55 A SL RD PTFE ACM 81-35553-00 0127.43 85x105 A SL LD PTFE ACM 81-35552-00 0807.30 27x47 A SL RD PTFE ACM	













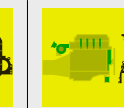

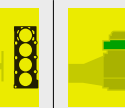
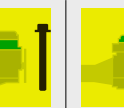
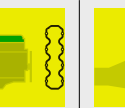
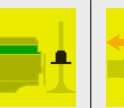
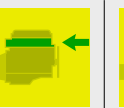

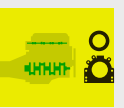
CITROEN

Ltr.  1,6 9HF (DV6DTE) 66 kW (90 PS) BERLINGO HDI 90  07/10 

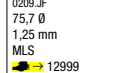
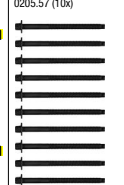
										
	<p>02-40903-01</p> 	<p>08-42514-01</p> 	<p>04-10340-01 </p> 	<p>61-10039-00 0209.JN 76 Ø 1,25 mm MLS</p> <p>61-10039-10 0209.JP 76 Ø 1,3 mm MLS</p> <p>61-10039-20 0209.JQ 76 Ø 1,35 mm MLS</p> <p>61-10039-30 0209.JR 76 Ø 1,4 mm MLS</p> <p>61-10039-40 0209.JS 76 Ø 1,45 mm MLS</p> 	<p>14-32336-01 0205.57 (10x)</p> 	<p>71-40903-00 0249.G2</p> 	<p>12-35548-01 0956.50 (8x)</p> <p>70-35548-00 0956.50</p> 	<p>71-39037-00 </p> <p>98 106 973 80</p> 	<p>70-31414-10</p> 	<p>81-35554-00 </p> <p>0127.42 40x55 A SL RD PTFE ACM</p>  <p>81-35553-00 </p> <p>0127.43 85x105 A SL LD PTFE ACM</p>  <p>81-35552-00 N</p> <p>0807.30 27x47 A SL RD PTFE ACM</p> 

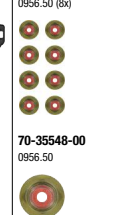
CITROEN



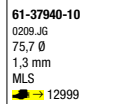
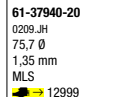
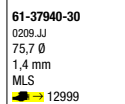
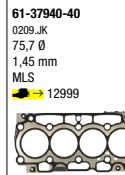
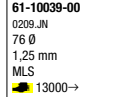
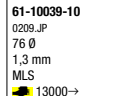
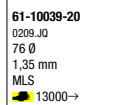
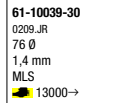
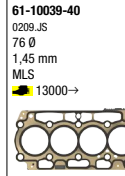

















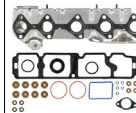



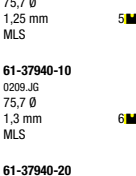

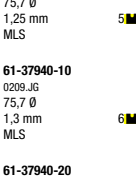





Ltr.  1,6 9HL (DV6C) 82-84 kW (112-114 PS) BERLINGO HDI 110 BERLINGO HDI 115 C4 AIRCROSS HDI C5 HDI 110 C5 HDI 115 07/10 

											
	02-40903-02 	08-42514-01 	04-10340-01 	61-37940-00 0209.JF 75,7 Ø 1,25 mm MLS  12999	14-32336-01 0205.57 (10x)  5	71-40903-00 0249.G2 	12-35548-01 0956.50 (8x)  8x	71-39037-00 	70-31414-10 	81-35554-00  K	81-35553-00  N
				61-37940-10 0209.JG 75,7 Ø 1,3 mm MLS  12999						0127.42 40x55 A SL RD PTFE ACM	0127.43 85x105 A SL LD PTFE ACM
				61-37940-20 0209.JH 75,7 Ø 1,35 mm MLS  12999							0807.30 27x47 A SL RD PTFE ACM
				61-37940-30 0209.JJ 75,7 Ø 1,4 mm MLS  12999							
				61-37940-40 0209.JK 75,7 Ø 1,45 mm MLS  12999							
				61-10039-00 0209.JN 76 Ø 1,25 mm MLS  13000→							
				61-10039-10 0209.JP 76 Ø 1,3 mm MLS  13000→							
				61-10039-20 0209.JQ 76 Ø 1,35 mm MLS  13000→							
				61-10039-30 0209.JR 76 Ø 1,4 mm MLS  13000→							
				61-10039-40 0209.JS 76 Ø 1,45 mm MLS  13000→							

CITROEN

Ltr.  1.6 9HR (DV6C) 82-84 kW (111-115 PS) 11/09

 BERLINGO HDI 110
BERLINGO HDI 115
C3 HDI 110
C3 PICASSO HDI
C4 Grand PICASSO HDI
C4 HDI
C4 HDI 110
C4 PICASSO HDI
C5 HDI 110
C5 HDI 115
DS3 HDI 110
DS4 HDI 110
DS5 HDI 110



										
	02-40903-01 	08-42514-01 	04-10340-01  	61-37940-00 0209.JF 75,7 Ø 1,25 mm MLS 5  	14-32336-01 0205.57 (10x) 6  	71-40903-00 0249.G2 	12-35548-01 0956.50 (8x) 7  	71-38503-00  0349.N5 12215  71-39037-00  98 106 973 80 12216 →  8x 	70-31414-10 	81-35554-00  0127.42 40x55 A SL RD PTFE ACM  81-35553-00  0127.43 85x105 A SL LD PTFE ACM  81-35552-00  0807.30 27x47 A SL RD PTFE ACM 

CITROEN

Ltr. 1.6 9HS (DV6TED4BU) 66 kW (90 PS) BERLINGO HDI 90 16V 04/08

	<p>02-36567-01</p>	<p>08-36869-01</p>	<p>04-10043-01 </p>	<p>61-36265-00 0209.CA 76 Ø 1,25 mm MLS</p> <p>61-36265-10 0209.CC 76 Ø 1,3 mm MLS</p> <p>61-36265-20 0209.CE 76 Ø 1,35 mm MLS</p> <p>61-36265-30 0209.CF 76 Ø 1,4 mm MLS</p> <p>61-36265-40 0209.CG 76 Ø 1,45 mm MLS</p> <p>61-36265-50 0209.HG 76 Ø 1,5 mm MLS</p> <p>61-36265-60 0209.HF 76 Ø 1,55 mm MLS</p> <p>61-36265-70 0209.HE 76 Ø 1,6 mm MLS</p> <p>61-36265-75 0209.HC 76 Ø 1,65 mm MLS</p>	<p>14-32336-01 0205.57 (10x)</p>	<p>71-36567-00 0249.C2</p>	<p>12-36587-01 0956.51 (16x)</p> <p>70-36587-00 0956.51</p>	<p>11-11022-01 </p> <p>40-76240-00 4x 0348.R5</p> <p>40-76919-00 4x 0348.R4</p> <p>71-35487-00 0349.J8</p>	<p>70-31414-10</p>	<p>81-35554-00 </p> <p>0127.42 40x55 A SL RD PTFE ACM</p> <p>81-35553-00 </p> <p>0127.43 85x105 A SL LD PTFE ACM</p> <p>81-35552-00 </p> <p>0807.30 27x47 A SL RD PTFE ACM</p>		

CITROEN

Ltr.  1,6 9HU (DV6UTED4) 66 kW (90 PS)  JUMPY HDI 90 16V  01/07-03/16

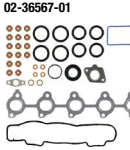
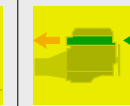

02-36567-01



04-10043-01



61-36265-00
0209.CA
76 Ø
1,25 mm
MLS



61-36265-10
0209.CC
76 Ø
1,3 mm
MLS



61-36265-20
0209.CE
76 Ø
1,35 mm
MLS

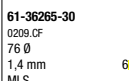

61-36265-30
0209.CF
76 Ø
1,4 mm
MLS

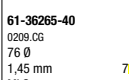

61-36265-40
0209.CG
76 Ø
1,45 mm
MLS



14-32206-01
0204.A2 (10x)

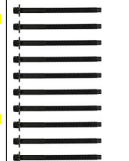

71-36567-00
0249.C2



12-36587-01
0956.S1 (16x)

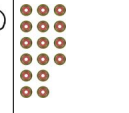

70-36587-00
0956.S1



11-11022-01

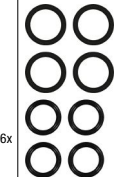

40-76240-00
0348.R5



40-76919-00
0348.R4



71-35487-00
0349.J8



70-31414-10



81-35554-00

0127.42
40x55
A SL RD PTFE ACM

























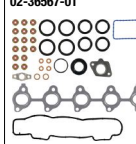



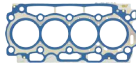

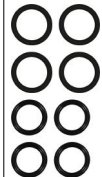

81-35553-00

0127.43
85x105
A SL LD PTFE ACM



CITROEN

Ltr.  1,6 9HW (DV6BTD4) 55 kW (75 PS) BERLINGO HDI 75  07/05-12/11 

										
	<p>02-36567-01</p> 	<p>08-36869-01</p> 	<p>04-10043-01 </p> 	<p>61-36265-00 0209.CA 76 Ø 1,25 mm MLS</p> <p>61-36265-10 0209.CC 76 Ø 1,3 mm MLS</p> <p>61-36265-20 0209.CE 76 Ø 1,35 mm MLS</p> <p>61-36265-30 0209.CF 76 Ø 1,4 mm MLS</p> <p>61-36265-40 0209.CG 76 Ø 1,45 mm MLS</p> <p>61-36265-50 0209.HG 76 Ø 1,5 mm MLS</p> <p>61-36265-60 0209.HF 76 Ø 1,55 mm MLS</p> <p>61-36265-70 0209.HE 76 Ø 1,6 mm MLS</p> <p>61-36265-75 0209.HC 76 Ø 1,65 mm MLS</p> 	<p>14-32206-01 0204.A2 (10x)</p> 	<p>71-36567-00 0249.C2</p> 	<p>12-36587-01 0956.S1 (16x)</p> <p>70-36587-00 0956.S1</p> 	<p>11-11022-01 </p>  <p>40-76240-00  4x 0348.R5</p> <p>40-76919-00  4x 0348.R4</p> <p>71-35487-00  0349.J8</p> 	<p>70-31414-10</p> 	<p>81-35554-00 </p> <p>0127.42 40x55 A SL RD PTFE ACM</p>  <p>81-35553-00 </p> <p>0127.43 85x105 A SL LD PTFE ACM</p>  <p>81-35552-00 N</p> <p>0807.30 27x47 A SL RD PTFE ACM</p> 

CITROEN















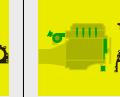

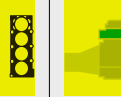

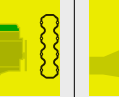
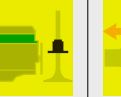
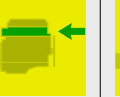





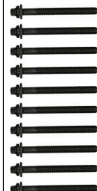





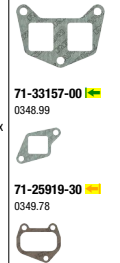



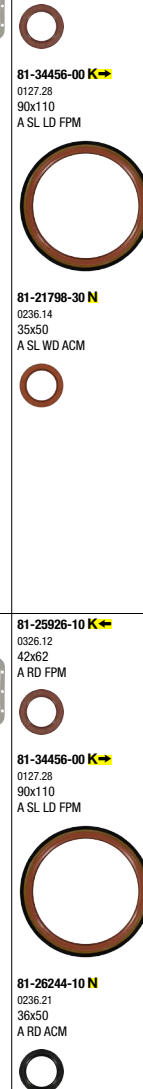
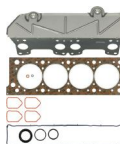

Ltr. 1,6 9HW (DV6ETED) 55 kW (75 PS) 1

	02-40903-02 	08-42514-01 		61-10039-00 0209.JN 76 Ø 1,25 mm MLS 2	14-32336-01 0205.57 (10x) 	71-40903-00 0249.G2 	12-35548-01 0956.50 (8x) 	71-39037-00 98 106 973 80 	70-31414-10 	81-35554-00 K 0127.42 40x55 A SL RD PTFE ACM 		81-35553-00 K 0127.43 85x105 A SL LD PTFE ACM
				61-10039-10 0209.JP 76 Ø 1,3 mm MLS 4			70-35548-00 0956.50 8x 					81-35552-00 N 0807.30 27x47 A SL RD PTFE ACM
				61-10039-20 0209.JQ 76 Ø 1,35 mm MLS 1								
				61-10039-30 0209.JR 76 Ø 1,4 mm MLS 4								
				61-10039-40 0209.JS 76 Ø 1,45 mm MLS 5								

1,8 AJZ (XUD7TE) 66 kW (90 PS) BX TRD 03/88-12/94
A8A (XUD7TE) BX 18 TRD

	02-25942-05 12/90 	08-25918-02 		61-33670-00 0209.00 82 Ø 1,54 mm 2	14-32077-01 0204.65 (10x) 	71-25942-00 0249.91 	12-25837-01 0956.22 (8x) 	71-33682-00 0348.89 12/90 	71-25918-30 0304.34 	81-25926-10 K 0326.12 42x62 A RD FPM 		81-34456-00 K 0127.28 90x110 A SL LD FPM
	02-25942-06 01/91 → 			61-33670-10 0209.01 82 Ø 1,64 mm 3			70-25837-00 0956.22 8x 	71-33683-00 0348.J0 01/91 → 				
								50-92244-00 1721.01 				

CITROEN

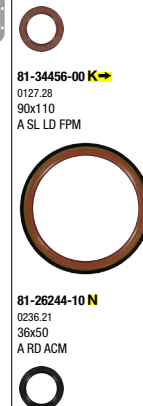
<p>Ltr. </p> <p>1,8 A9A (XUD7) XUD7A 161 (XUD7) 161A (XUD7)</p> <p>43-44 kW (58-60 PS)</p> <p>BERLINGO D BX 18 D C15 D VISA 17 D XSARA D ZX ZX D</p> <p>04/84-10/02</p>            	<p>02-25942-03 0197.H4</p>  <p>02-25942-04 0197.H4 +0956.22 (8x)</p> 	<p>08-25918-02</p> 			<p>61-29145-10 0209.F9 82 Ø 1,6 mm</p> <p>61-29145-20 0209.G0 82 Ø 1,7 mm</p> <p>61-31060-00 0209.S0 82 Ø 1,4 mm</p> <p>61-31060-10 0209.S1 82 Ø 1,45 mm</p> <p>61-31060-20 0209.S2 82 Ø 1,5 mm</p> <p>61-31060-30 0209.S3 82 Ø 1,55 mm</p> <p>61-31060-40 0209.S4 82 Ø 1,6 mm</p> 	<p>14-32077-01 0204.65 (10x)</p> 	<p>71-25942-00 0249.91</p> 	<p>12-25837-01 0956.22 (8x)</p> <p>70-25837-00 0956.22</p> 	<p>71-33156-00  2x 0348.98</p> <p>71-33157-00  2x 0348.99</p> <p>71-25919-30  2x 0349.78</p> 	<p>71-25918-30 0304.34</p> 	<p>81-25926-10  0326.12 42x62 A RD FPM</p> <p>81-34456-00  0127.28 90x110 A SL LD FPM</p> <p>81-21798-30 N 0236.14 35x50 A SL WD ACM</p> <p>81-25926-10  0326.12 42x62 A RD FPM</p> <p>81-34456-00  0127.28 90x110 A SL LD FPM</p> <p>81-26244-10 N 0236.21 36x50 A RD ACM</p> 
<p>1,8 LFX (XU7JB)</p> <p>58-66 kW (79-90 PS)</p> <p>BERLINGO XANTIA XSARA</p> <p>04/97-04/04</p>	<p>02-25415-09</p> 	<p>08-25918-05</p> 			<p>61-25415-30 0209.E1 84 Ø 1,3 mm</p> <p>61-25415-40 0209.L3 84 Ø 1,5 mm</p> 		<p>71-33664-00 0249.71</p> 	<p>12-25837-01 0956.22 (8x)</p> <p>70-25837-00 0956.22</p> 	<p>71-34418-00  4x 0348.L7</p> <p>71-35364-00  1723.63</p> 	<p>71-25918-30 0304.34</p> 	<p>81-25926-10  0326.12 42x62 A RD FPM</p> <p>81-34456-00  0127.28 90x110 A SL LD FPM</p> <p>81-26244-10 N 0236.21 36x50 A RD ACM</p> 

CITROEN

Ltr.  1.8 LFY (XU7JP4) 76-82 kW (103-112 PS) XANTIA 16V XSARA XSARA PICASSO XSARA 16V ZX ZX 16V



06/95-08/05

01-35040-01
0197.V5
+0209.03
+0249.A2
+0249.A3
→ 07965

01-35040-02
0197.X7
+0209.03
+0249.A2
+0249.A3
→ 07966→

02-35040-01
→ 07965

02-35040-02
→ 07966→



61-35040-00
0209.03
84 Ø

14-32155-01
0204.80 (10x)

71-34446-00 R
0249.A3

71-34447-00 L
0249.A2

12-35257-01
0956.34 (16x)
→ 07363

12-34438-01
0956.42 (16x)
→ 07364→
→ 07965

12-34439-01
0956.45 (16x)
→ 07966→

70-35257-00
0956.34
→ 07363

70-34438-00
0956.42
→ 07364→
→ 07965

70-34439-00
0956.45
→ 07966→

71-33666-00  
0348.C8
→ 07037



71-35899-00  4x
0348.K6
→ 07038→



71-34443-00 
0349.F4
→ 07664

71-35768-00 
0349.H0
→ 07665→























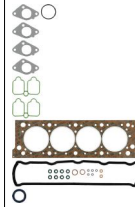
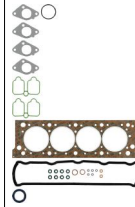

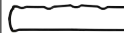









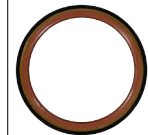

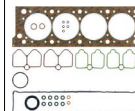







70-31414-10

81-25826-10  
0326.12
42x62
A RD FPM

81-34456-00  
0127.28
90x110
A SL LD FPM

81-34403-00   2x
0236.44
36x50
A SL FPM

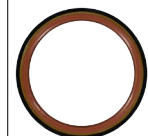
CITROEN

Ltr. 											
1,8 LFZ (XU7JP) 73-76 kW (99-103 PS) EVASION EVASION 02/96-07/02  1		02-25415-06 	08-25918-05 		61-25415-30 0209.E1 84 Ø 1,3 mm 61-25415-40 0209.L3 84 Ø 1,5 mm 	14-32079-01 0204.57 (10x)	71-26237-00 0249.48 	12-25837-01 0956.22 (8x) 70-25837-00 0956.22 	71-33663-00  2x 0348.F6  71-26236-10  4x 0349.70 	71-25918-30 0304.34 	81-25926-10  0326.12 42x62 A RD FPM  81-34456-00  0127.28 90x110 A SL LD FPM  81-26244-10 N 0236.21 36x50 A RD ACM 
1,8 LFZ (XU7JP) 74-76 kW (101-103 PS) XANTIA XSARA ZX ZX 03/91-09/00		02-25415-05 0197.64 	08-25918-05 		61-25415-30 0209.E1 84 Ø 1,3 mm 61-25415-40 0209.L3 84 Ø 1,5 mm 	14-32079-01 0204.57 (10x)	71-33664-00 0249.71 	12-25837-01 0956.22 (8x) 70-25837-00 0956.22 	71-33663-00  2x 0348.F6  71-33738-00   2x 0348.E6  71-35364-00   1723.63 	71-25918-30 0304.34 	81-25926-10  0326.12 42x62 A RD FPM  81-34456-00  0127.28 90x110 A SL LD FPM  81-26244-10 N 0236.21 36x50 A RD ACM 

CITROEN													
Ltr.													
1,8 LFZ (XU7JP)	76 kW (103 PS)	EVASION	02/96-12/96		<p>02-25415-06</p>	<p>08-25918-05</p>	<p>61-25415-30 0209.E1 84 Ø 1,3 mm</p> <p>61-25415-40 0209.L3 84 Ø 1,5 mm</p>	<p>14-32078-01 0204.89 (10x)</p>	<p>71-26237-00 0249.48</p>	<p>12-25837-01 0956.22 (8x)</p>	<p>71-33663-00 </p> <p>0348.F6</p> <p>71-26236-10 </p> <p>0349.70</p> <p>8x</p>	<p>71-25918-30 0304.34</p>	<p>81-25926-10 </p> <p>0326.12 42x62 A RD FPM</p> <p>81-34456-00 </p> <p>0127.28 90x110 A SL LD FPM</p> <p>81-26244-10 N</p> <p>0236.21 36x50 A RD ACM</p>
1,8 LFZ (XU7JP)	76 kW (103 PS)	ZX	03/91-10/97		<p>02-25415-05 0197.64</p>	<p>08-25918-05</p>	<p>61-25415-30 0209.E1 84 Ø 1,3 mm</p> <p>61-25415-40 0209.L3 84 Ø 1,5 mm</p>	<p>14-32078-01 0204.89 (10x)</p>	<p>71-33664-00 0249.71</p>	<p>12-25837-01 0956.22 (8x)</p>	<p>71-33663-00 </p> <p>0348.F6</p> <p>71-33738-00 </p> <p>0348.E6</p> <p>8x</p> <p>71-35364-00 </p> <p>1723.63</p>	<p>71-25918-30 0304.34</p>	<p>81-25926-10 </p> <p>0326.12 42x62 A RD FPM</p> <p>81-34456-00 </p> <p>0127.28 90x110 A SL LD FPM</p> <p>81-26244-10 N</p> <p>0236.21 36x50 A RD ACM</p>
1,8 169 (XM7T)	50-51 kW (68-69 PS)	C25	11/81-02/94										

CITROEN

Ltr.  4N13 103 kW (140 PS)  C4 AIRCROSS HDI 150  04/12

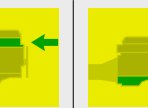
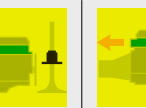
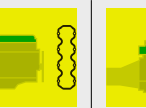
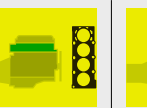
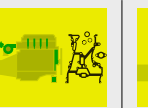

01-54168-01
16 076 040 80

61-54100-00
16 075 923 80
84,5 Ø
1,3 mm
MLS



61-54100-10
16 075 922 80
84,5 Ø
1,35 mm
MLS



61-54100-20
16 075 924 80
84,5 Ø
1,4 mm
MLS



14-13365-01
16 075 986 80 (10X)



71-54168-00
16 075 920 80

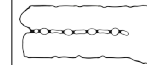

12-54169-01
16 081 661 80 (8x)
+16 081 663 80 (8x)

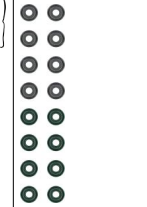

70-54169-00 ES 8x
16 081 663 80



70-54171-00 AS 8x
16 081 661 80



71-54172-00 
16 075 917 80



71-54173-00 
16 075 910 80



70-31414-10

81-54174-00 
16 075 931 80
70x85
A SL RD FPM



81-54176-00 
16 075 933 80
95x111
A SL LD FPM



1,8 4N13 110 kW (150 PS) C4 AIRCROSS HDI 04/12



01-54168-01
16 076 040 80

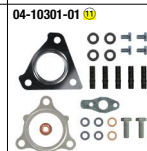

04-10301-01 

61-54100-00
16 075 923 80
84,5 Ø
1,3 mm
MLS



61-54100-10
16 075 922 80
84,5 Ø
1,35 mm
MLS



61-54100-20
16 075 924 80
84,5 Ø
1,4 mm
MLS



14-13365-01
16 075 986 80 (10X)



71-54168-00
16 075 920 80

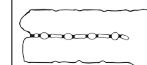

12-54169-01
16 081 661 80 (8x)
+16 081 663 80 (8x)

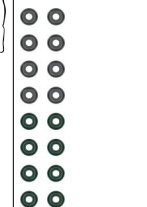

70-54169-00 ES 8x
16 081 663 80



70-54171-00 AS 8x
16 081 661 80



71-54172-00 
16 075 917 80

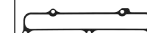

71-54173-00 
16 075 910 80



70-31414-10

81-54174-00 
16 075 931 80
70x85
A SL RD FPM



81-54176-00 
16 075 933 80
95x111
A SL LD FPM



CITROEN

Ltr.  1.8 6FY (EW7A) 86-92 kW (117-125 PS) C4 C4 PICASSO C4 PICASSO 16V C4 16V C5 16V

 09/05



61-37355-00
0209.FR
MLS

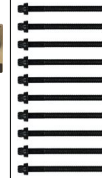
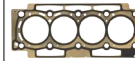

14-32342-01
0204.A3 (10x)

12-34439-01
0956.45 (16x)



70-34439-00
0956.45



16x

71-38549-00  4x
0348.S2



71-34992-00 
0349.L4



70-31414-10



81-34454-10 

16 089 406 80
40x55
A SL RD PTFE



81-34456-00 

0127.28
90x110
A SL LD FPM



81-34403-00 

0236.44
36x50
A SL FPM



























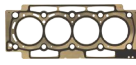



81-38657-00 

0236.74
39x50
A SL RD PTFE
(Polytetrafluorethylen)/ACM
(Polyacryl-Kautschuk)











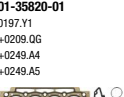

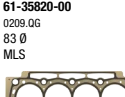

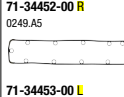
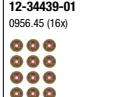



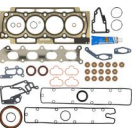
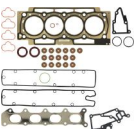

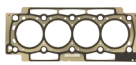







CITROEN





























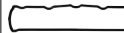
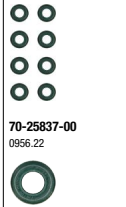











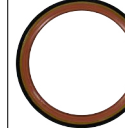









Ltr.  1.8 6FZ (EW7A)  85 kW (115 PS)  1

										
				<p>61-37355-00 0209.FR MLS</p> 			<p>12-34439-01 0956.45 (16x)</p>  <p>70-34439-00 0956.45</p> 	<p>71-38549-00  4x 0348.S2</p>  <p>71-34992-00  0349.L4</p> 	<p>70-31414-10</p> 	<p>81-34454-10  16 089 406 80 40x55 A SL RD PTFE</p>  <p>81-34456-00  0127.28 90x110 A SL LD FPM</p>  <p>81-34403-00 N 0236.44 36x50 A SL FPM</p>  <p>81-38657-00 N 0236.74 39x50 A SL RD PTFE (Polytetrafluorethylen)/ACM (Polyacryl-Kautschuk)</p> 





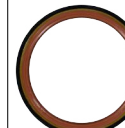



















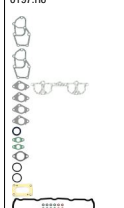

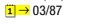





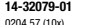
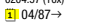
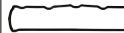



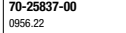











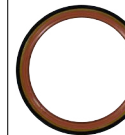

















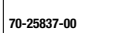



1,8 6FZ (EW7J4) 85 kW (115-116 PS) C5
C5 16V
XSARA
XSARA PICASSO 16V

										
<p>01-35820-01 0197.Y1 +0209.QG +0249.A4 +0249.A5</p> 	<p>02-35820-01</p> 	<p>08-37006-01</p> 		<p>61-35820-00 0209.0G 83 0 MLS</p> 	<p>14-32234-01 0204.A7 (10x)</p> 	<p>71-34452-00 R 0249.A5</p>  <p>71-34453-00 L 0249.A4</p> 	<p>12-34439-01 0956.45 (16x)</p>  <p>70-34439-00 0956.45</p> 	<p>71-35903-00  4x 0348.P1</p>  <p>71-33853-00  0349.H8</p> 	<p>70-31414-10</p> 	<p>81-34454-10  16 089 406 80 40x55 A SL RD PTFE</p>  <p>81-34456-00  0127.28 90x110 A SL LD FPM</p>  <p>81-34403-00 N 2x 0236.44 36x50 A SL FPM</p> 

CITROEN

<p>Ltr. </p>													
<p>1,9 DDZ (XU9M) 80 kW (109 PS) BX 19 06/88-12/94</p>	<p>15-25415-04 0197.H7 +0209.E1</p> 	<p>02-25415-03 0197.H6 +0209.E1</p>  <p>02-26237-01 0197.H6</p> 	<p>08-25918-05</p> 		<p>61-25415-30 0209.E1 84 Ø 1,3 mm</p> <p>61-25415-40 0209.L3 84 Ø 1,5 mm</p> 	<p>14-32079-01 0204.57 (10x)</p>	<p>71-26237-00 0249.48</p> 	<p>12-25837-01 0956.22 (8x)</p>  <p>70-25837-00 0956.22</p> 	<p>71-31379-10  4x 0349.91</p>  <p>71-26236-10 4x 0349.70</p>  <p>50-92244-00   8x 1721.01</p> 	<p>71-25918-30 0304.34</p> 	<p>81-25926-10  K</p> <p>0326.12 42x62 A RD FPM</p>  <p>81-34456-00  K</p> <p>0127.28 90x110 A SL LD FPM</p>  <p>81-34403-00 N</p> <p>0236.44 36x50 A SL FPM</p> 		
<p>1,9 DFW (XU9J4) 108-118 kW (147-160 PS) BX 09/87-12/93</p>	<p>02-25415-07 0197.J2 +0209.L3</p> 	<p>08-25918-05</p>  <p>02-33668-01 0197.J2</p> 			<p>61-25415-30 0209.E1 84 Ø 1,3 mm</p> <p>61-25415-40 0209.L3 84 Ø 1,5 mm</p> 	<p>14-32079-01 0204.57 (10x)</p>	<p>71-33668-00 0249.74</p> 	<p>12-26058-03 0956.19 (16x)</p>  <p>70-26058-00 0956.19</p> 	<p>71-33684-00  2x 0348.G4</p>  <p>71-33686-00   16x 0349.E8</p> 	<p>71-25918-30 0304.34</p> 	<p>81-25926-10  K</p> <p>0326.12 42x62 A RD FPM</p>  <p>81-34456-00  K</p> <p>0127.28 90x110 A SL LD FPM</p>  <p>81-22660-00 N 2x</p> <p>0236.24 32x45 A LD FPM</p>  <p>81-26244-10 N 2x</p> <p>0236.21 36x50 A RD ACM</p> 		

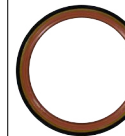











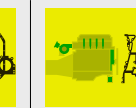

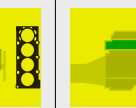

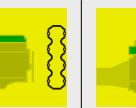
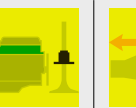
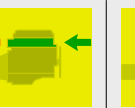

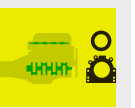
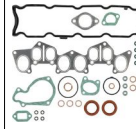
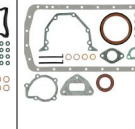
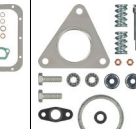

















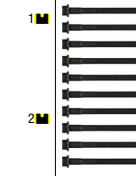
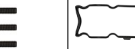
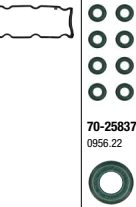

CITROEN

Ltr. 											
1,9 DFZ (XU9J1) 75 kW (102 PS) BX 19 07/86-12/94 	 02-25415-03 0197.H6 +0209.E1  02-26237-01 0197.H6 	08-25918-05 			61-25415-30 0209.E1 84 Ø 1,3 mm 61-25415-40 0209.L3 84 Ø 1,5 mm 	14-32078-01 0204.89 (10x)  ⇒ 03/87       14-32079-01 0204.57 (10x)  04/87 →	71-26237-00 0249.48 	12-25837-01 0956.22 (8x)     70-25837-00 0956.22 	71-31379-10  0349.91  71-26236-10  4x 0349.70  50-92244-00   1721.01 	71-25918-30 0304.34 	81-25926-10  0326.12 42x62 A RD FPM  81-34456-00  0127.28 90x110 A SL LD FPM 
1,9 DHV (XUD9BSD) 55-68 kW (75-92 PS) EVASION TD DHW (XUD9SSD) JUMPER Bus TD DHY (XUD9TE/Y) JUMPER TD D8B (XUD9TF) JUMPER TD D8C (XUD9UTF) JUMPER TD XANTIA SD XANTIA TD XSARA D XSARA SD XSARA TD ZX DT ZX TD	02-25942-06 	08-25918-02 			61-33155-00 0209.08 84 Ø 1,36 mm MLS  1 61-33155-10 0209.09 84 Ø 1,4 mm MLS  2 61-33155-20 0209.R0 84 Ø 1,44 mm MLS  3 61-33155-30 0209.R1 84 Ø 1,48 mm MLS  4 61-33155-40 0209.R2 84 Ø 1,53 mm MLS  5 61-33155-50 0209.T7 84 Ø 1,59 mm MLS 61-33155-60 84 Ø 1,7 mm MLS 	14-32177-01 0204.73 (10x)      	71-25942-00 0249.91 	12-25837-01 0956.22 (8x)     70-25837-00 0956.22 	71-33683-00   0348.J0  50-92244-00   1721.01 	71-25918-30 0304.34 	81-25926-10  0326.12 42x62 A RD FPM  81-34456-00  0127.28 90x110 A SL LD FPM  81-21798-30 N 0236.14 35x50 A SL WD ACM 



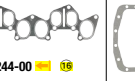



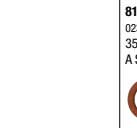

















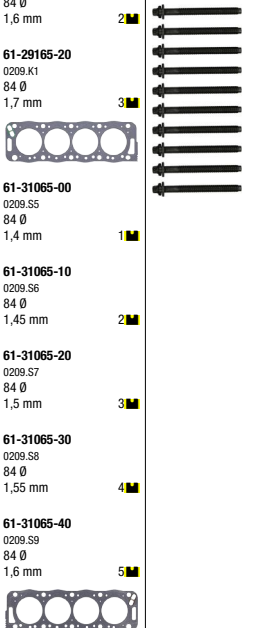

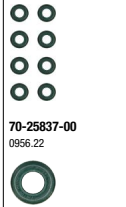









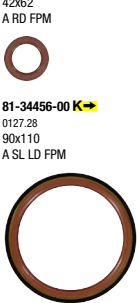





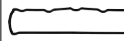
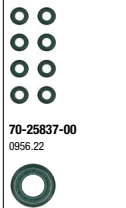









CITROEN

Ltr.  1.9 DHX (XUD9BTF) 66-68 kW (90-92 PS) EVASION TD JUMPER TD JUMPY TD XANTIA TD

 05/93

											
	02-25942-06 	08-25918-02 	04-10241-01 	61-33155-00 0209.08 84 Ø 1,36 mm MLS  1  2  3  4  5  61-33155-10 0209.09 84 Ø 1,44 mm MLS  3  4  5  61-33155-20 0209.R0 84 Ø 1,44 mm MLS  3  4  5  61-33155-30 0209.R1 84 Ø 1,48 mm MLS  4  5  61-33155-40 0209.R2 84 Ø 1,53 mm MLS  5  61-33155-50 0209.T7 84 Ø 1,59 mm MLS  61-33155-60 84 Ø 1,7 mm MLS 	14-32177-01 0204.73 (10x) 	71-25942-00 0249.91 	12-25837-01 0956.22 (8x) 	71-33683-00  0348.J0 50-92244-00  1721.01 8x 	71-25918-30 0304.34 	81-25926-10  0326.12 42x62 A RD FPM 81-34456-00  0127.28 90x110 A SL LD FPM 81-21798-30  0236.14 35x50 A SL WD ACM 	

CITROEN





















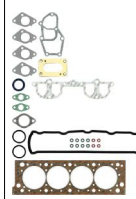
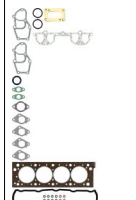
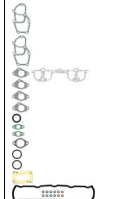

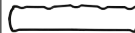
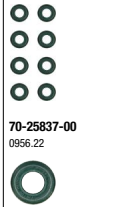





<p>Ltr. </p>											
<p>1,9 DJY (XUD9A) 47-53 kW (64-72 PS) BERLINGO D DJZ (XUD9A) BX D9B (XUD9) BX 19 D D9B (XUD9A/L) C25 D D9B (XUD9A/U) JUMPER Bus D JUMPER D JUMPY D XANTIA D XSARA D ZX D</p>	<p>09/83-12/03</p>	<p>02-25942-05</p> 	<p>08-25918-02</p> 		<p>61-29165-10 0209.K0 84 Ø 1,6 mm</p> <p>61-29165-20 0209.K1 84 Ø 1,7 mm</p> <p>61-31065-00 0209.S5 84 Ø 1,4 mm</p> <p>61-31065-10 0209.S6 84 Ø 1,45 mm</p> <p>61-31065-20 0209.S7 84 Ø 1,5 mm</p> <p>61-31065-30 0209.S8 84 Ø 1,55 mm</p> <p>61-31065-40 0209.S9 84 Ø 1,6 mm</p> 	<p>14-32077-01 0204.65 (10x)</p> 	<p>71-25942-00 0249.91</p> 	<p>12-25837-01 0956.22 (8x)</p> <p>70-25837-00 0956.22</p> 	<p>71-33682-00  </p> <p>0348.89</p> <p>50-92244-00  </p> <p>1721.01</p> <p>8x </p>	<p>71-25918-30 0304.34</p> 	<p>81-25926-10  </p> <p>0326.12 42x62 A RD FPM</p> <p>81-34456-00  </p> <p>0127.28 90x110 A SL LD FPM</p>  <p>81-21798-30 </p> <p>0236.14 35x50 A SL WD ACM</p> 
<p>1,9 DKZ (XU9JA) 70-92 kW (95-125 PS) BX D2C (XU92C) BX 19 D2E BX 19 GTI D2F ZX D6A (XU9J2) D6U</p>	<p>09/84-06/97</p>	<p>15-25415-04 0197.H7 +0209.E1</p> 	<p>02-25415-03 0197.H6 +0209.E1</p> 	<p>08-25918-05</p> 	<p>61-25415-30 0209.E1 84 Ø 1,3 mm</p> <p>61-25415-40 0209.L3 84 Ø 1,5 mm</p> 	<p>14-32079-01 0204.57 (10x)</p>	<p>71-26237-00 0249.48</p> 	<p>12-25837-01 0956.22 (8x)</p> <p>70-25837-00 0956.22</p> 	<p>71-31379-10  </p> <p>0349.91</p> <p>71-26236-10  </p> <p>0349.70</p> <p>4x </p> <p>8x </p> <p>50-92244-00  </p> <p>1721.01</p> 	<p>71-25918-30  </p> <p>0304.34</p> 	<p>81-25926-10  </p> <p>0326.12 42x62 A RD FPM</p> <p>81-34456-00  </p> <p>0127.28 90x110 A SL LD FPM</p>  <p>81-34403-00 </p> <p>0236.44 36x50 A SL FPM</p> 

CITROEN

Ltr.	Engine	Power	Model	Year	Part 1	Part 2	Part 3	Part 4	Part 5	Part 6	Part 7	Part 8	Part 9	Part 10	Part 11
1,9	D2A (XU92C) D2C (XU92C) 159A	70-77 kW (95-105 PS)	BX 19	07/86-12/94	15-25415-04 0197.H7 +0209.E1 	02-25415-03 0197.H6 +0209.E1 	08-25918-05 		61-25415-30 0209.E1 84 Ø 1,3 mm 61-25415-40 0209.L3 84 Ø 1,5 mm 	14-32078-01 0204.89 (10x) E1 ⇒ 03/87 	71-26237-00 0249.48 	12-25837-01 0956.22 (8x) 	71-31379-10 0349.91 71-26236-10 4x 0349.70 50-92244-00 8x 16 1721.01 	71-25918-30 24 0304.34 81-25926-10 K 0326.12 42x62 A RD FPM 81-34456-00 K 0127.28 90x110 A SL LD FPM 81-34403-00 N 0236.44 36x50 A SL FPM	
1,9	D6A (XU9J2)	90-92 kW (122-125 PS)	BX GTI BX 19 BX 19 D BX 19 GTI	10/84-06/94	15-25415-04 0197.H7 +0209.E1 	02-25415-03 0197.H6 +0209.E1 	08-25918-05 		61-25415-30 0209.E1 84 Ø 1,3 mm 61-25415-40 0209.L3 84 Ø 1,5 mm 	14-32078-01 0204.89 (10x) 	71-26237-00 0249.48 	12-25837-01 0956.22 (8x) 	71-31379-10 0349.91 71-26236-10 4x 0349.70 50-92244-00 8x 16 1721.01 	71-25918-30 24 0304.34 81-25926-10 K 0326.12 42x62 A RD FPM 81-34456-00 K 0127.28 90x110 A SL LD FPM 81-34403-00 N 0236.44 36x50 A SL FPM	













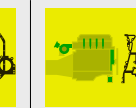

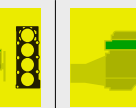

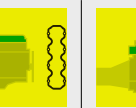
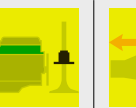
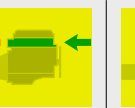

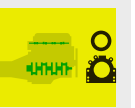

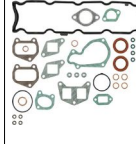
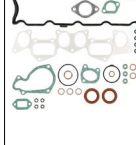

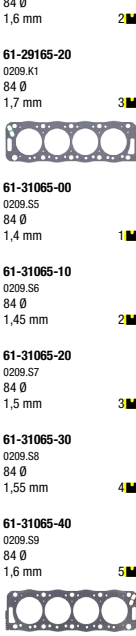

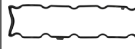















CITROEN

Ltr.  1.9 D6E (XU9JA) 93-96 kW (126-131 PS) ZX  03/91-06/97













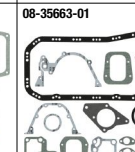
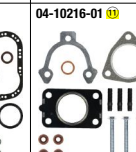
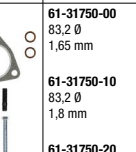
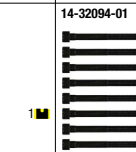
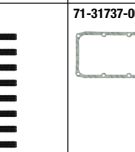
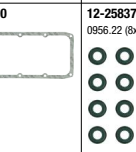
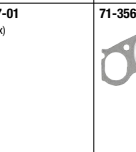
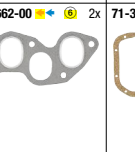
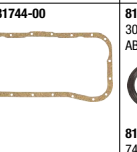

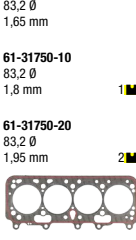



										
	<p>02-25415-03 0197.H6 +0209.E1</p>  <p>02-25415-08 0197.H6 +0209.L3</p>  <p>02-26237-01 0197.H6</p> 	<p>08-25918-05</p> 		<p>61-25415-30 0209.E1 84 Ø 1,3 mm</p> <p>61-25415-40 0209.L3 84 Ø 1,5 mm</p> 	<p>14-32079-01 0204.57 (10x)</p>	<p>71-26237-00 0249.48</p> 	<p>12-25837-01 0956.22 (8x)</p>  <p>70-25837-00 0956.22</p> 	<p>71-31379-10  </p> <p>0349.91</p>  <p>71-26236-10  4x</p> <p>0349.70</p>  <p>71-27178-10  </p> <p>1710.39</p> 	<p>71-25918-30 0304.34</p> 	<p>81-25826-10  </p> <p>0326.12 42x62 A RD FPM</p>  <p>81-34456-00  </p> <p>0127.28 90x110 A SL LD FPM</p> 

CITROEN













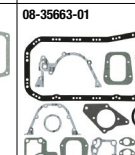

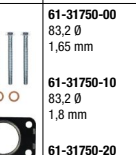
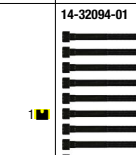
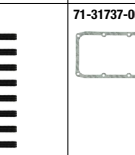
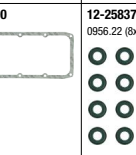
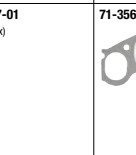
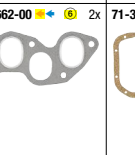
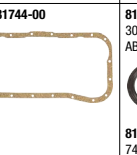

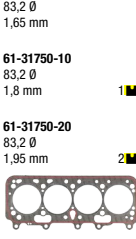



Ltr.  1.9 D9A (XUD9) 47 kW (64 PS) BX 19 D  09/83-11/94

											
	<p>02-25942-03 0197.H4 1 → 03/87</p>  <p>02-25942-04 0197.H4 +0956.22 (8x) 1 → 03/87</p>  <p>02-25942-05 04/87 →</p> 	<p>08-25918-02</p> 		<p>61-29165-10 0209.K0 84 Ø 1,6 mm 2</p> <p>61-29165-20 0209.K1 84 Ø 1,7 mm 3</p> <p>61-31065-00 0209.S5 84 Ø 1,4 mm 1</p> <p>61-31065-10 0209.S6 84 Ø 1,45 mm 2</p> <p>61-31065-20 0209.S7 84 Ø 1,5 mm 3</p> <p>61-31065-30 0209.S8 84 Ø 1,55 mm 4</p> <p>61-31065-40 0209.S9 84 Ø 1,6 mm 5</p> 	<p>14-32077-01 0204.65 (10x)</p> 	<p>71-25942-00 0249.91</p> 	<p>12-25837-01 0956.22 (8x)</p>  <p>70-25837-00 0956.22</p> 	<p>71-33156-00  </p> <p>0348.98 1 → 03/87</p>  <p>71-33157-00  </p> <p>0348.99 1 → 03/87</p>  <p>71-33682-00   </p> <p>0348.89 1 04/87 →</p>  <p>71-25919-30 </p> <p>0349.78 1 → 03/87</p>  <p>50-92244-00  </p> <p>1721.01</p> 	<p>71-25918-30 0304.34</p> 	<p>81-25826-10  </p> <p>0326.12 42x62 A RD FPM</p>  <p>81-34456-00  </p> <p>0127.28 90x110 A SL LD FPM</p>  <p>81-21798-30 </p> <p>0236.14 35x50 A SL WD ACM</p> 	

























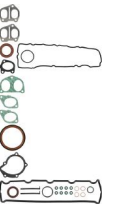
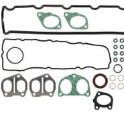

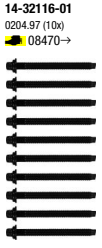
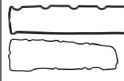









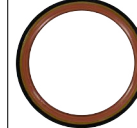

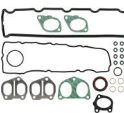

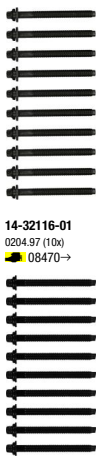
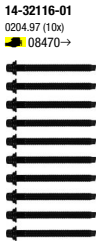

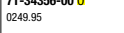
1.9 M705 60 kW (82 PS) C25 DT 10/91-01/94

											
01-31737-04	02-31737-01	08-35663-01	04-10216-01 	<p>61-31750-00 83,2 Ø 1,65 mm</p> <p>61-31750-10 83,2 Ø 1,8 mm 1</p> <p>61-31750-20 83,2 Ø 1,95 mm 2</p> 	<p>14-32094-01</p> 	71-31737-00	<p>12-25837-01 0956.22 (8x)</p>  <p>70-25837-00 0956.22</p> 	<p>71-35662-00   </p> <p>0349.78 2x</p> 	71-31744-00	<p>81-35624-00  </p> <p>30x43 AB SL RD FPM</p>  <p>81-35881-00  </p> <p>74x90 AB SL LD FPM/ACM</p> 	

1.9 M705 60 kW (82 PS) C25 TD 04/92-02/94

											
01-31737-04	02-31737-01	08-35663-01	04-10221-01 	<p>61-31750-00 83,2 Ø 1,65 mm</p> <p>61-31750-10 83,2 Ø 1,8 mm 1</p> <p>61-31750-20 83,2 Ø 1,95 mm 2</p> 	<p>14-32094-01</p> 	71-31737-00	<p>12-25837-01 0956.22 (8x)</p>  <p>70-25837-00 0956.22</p> 	<p>71-35662-00   </p> <p>0349.78 2x</p> 	71-31744-00	<p>81-35624-00  </p> <p>30x43 AB SL RD FPM</p>  <p>81-35881-00  </p> <p>74x90 AB SL LD FPM/ACM</p> 	

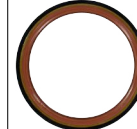
CITROEN















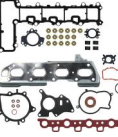











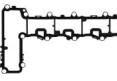







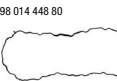











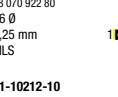







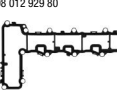





<p>Ltr. </p>													
<p>1,9 WJX (DW8B) 44 kW (60 PS) C15 D 12/00-12/05</p>	<p>01-34356-01 0197.X6 +0127.28 +0326.22 +0807.14</p> 	<p>02-34356-01 0197.X5 +0807.14</p> 			<p>61-33720-00 0209.X0 84 Ø 1,26 mm MLS</p> <p>61-33720-10 0209.X1 84 Ø 1,3 mm MLS</p> <p>61-33720-20 0209.X2 84 Ø 1,34 mm MLS</p> <p>61-33720-30 0209.X3 84 Ø 1,38 mm MLS</p> <p>61-33720-40 0209.X4 84 Ø 1,42 mm MLS</p> <p>61-33720-50 0209.1C 84 Ø 1,47 mm MLS</p> 	<p>14-32077-01 0204.65 (10x) 08469</p>  <p>14-32116-01 0204.97 (10x) 08470</p> 	<p>15-34356-01 0249.95 +0249.97</p>  <p>71-34353-00 U 0249.97</p>  <p>71-34356-00 O 0249.95</p> 	<p>12-25837-01 0956.22 (8x)</p>  <p>70-25837-00 0956.22</p> 	<p>71-34987-00 I 0348.N8</p>  <p>71-34988-00 I 0348.P0</p>  <p>71-29465-00 0349.H7</p> 	<p>71-25918-30 0304.34</p> 	<p>81-25926-10 K 0326.12 42x62 A RD FPM</p>  <p>81-34456-00 K 0127.28 90x110 A SL LD FPM</p>  <p>81-25451-10 N 0514.15 35x50 A SL RD FPM</p> 		
<p>1,9 WJY (DW8B) WJZ (DW8) 51-52 kW (69-72 PS) BERLINGO D C15 D JUMPY D JUMPY TD XSARA D 04/98-12/11</p>	<p>01-34356-01 0197.X6 +0127.28 +0326.22 +0807.14</p> 	<p>02-34356-01 0197.X5 +0807.14</p> 			<p>61-33720-00 0209.X0 84 Ø 1,26 mm MLS</p> <p>61-33720-10 0209.X1 84 Ø 1,3 mm MLS</p> <p>61-33720-20 0209.X2 84 Ø 1,34 mm MLS</p> <p>61-33720-30 0209.X3 84 Ø 1,38 mm MLS</p> <p>61-33720-40 0209.X4 84 Ø 1,42 mm MLS</p> <p>61-33720-50 0209.1C 84 Ø 1,47 mm MLS</p> 	<p>14-32077-01 0204.65 (10x) 08469</p>  <p>14-32116-01 0204.97 (10x) 08470</p> 	<p>15-34356-01 0249.95 +0249.97</p>  <p>71-34353-00 U 0249.97</p>  <p>71-34356-00 O 0249.95</p> 	<p>12-25837-01 0956.22 (8x)</p>  <p>70-25837-00 0956.22</p> 	<p>71-34987-00 I 0348.N8</p>  <p>71-34988-00 I 0348.P0</p>  <p>71-29465-00 0349.H7</p> 	<p>71-25918-30 0304.34</p> 	<p>81-25926-10 K 0326.12 42x62 A RD FPM</p>  <p>81-34456-00 K 0127.28 90x110 A SL LD FPM</p>  <p>81-25451-10 N 0514.15 35x50 A SL RD FPM</p> 		

CITROEN

























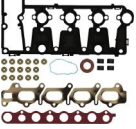



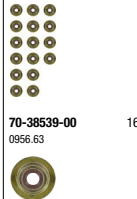







Ltr. 1,9 159B 74 kW (101 PS) 1

<p>15-25415-04 0197.H7 +0209.E1</p>	<p>02-25415-03 0197.H6 +0209.E1</p> <p>02-26237-01 0197.H6</p>	<p>08-25918-05</p>		<p>61-25415-30 0209.E1 84 Ø 1,3 mm</p> <p>61-25415-40 0209.L3 84 Ø 1,5 mm</p>	<p>14-32079-01 0204.57 (10x) 04/87→</p> <p>14-32078-01 0204.89 (10x)</p>	<p>71-26237-00 0249.48</p>	<p>12-25837-01 0956.22 (8x)</p> <p>70-25837-00 0956.22</p>	<p>71-31379-10 </p> <p>0349.91</p> <p>71-26236-10 4x 0349.70</p> <p>50-92244-00 10 1721.01</p>	<p>71-25918-30 </p> <p>0304.34</p>	<p>81-25826-10 </p> <p>0326.12 42x62 A RD FPM</p> <p>81-34456-00 </p> <p>0127.28 90x110 A SL LD FPM</p> <p>81-34403-00 </p> <p>0236.44 36x50 A SL FPM</p>	
<p>2.0 AHE (DW10FD) AHF (DW10FD) AHG (DW10FD) AHH (DW10FC) AHJ (DW10FE) AHK (DW10FE) AHR (DW10FD) AHS (DW10FD) AHU (DW10FCD) AHV (DW10FD) AHW (DW10FC) AHX (DW10FC) AHS (DW10FDDU370) EHT (DW10FDDU340) EHW (DW10FCD) EHY (DW10FCC) EHZ (DW10FDCC)</p>	<p>90-133 kW (122-181 PS)</p>	<p>C4 GRAND PICASSO HDI C4 HDI C4 PICASSO HDI C4 PICASSO HDI 135 C4 SPACETOURER HDI 150 C4 SPACETOURER HDI 160 C5 HDI 150 C5 HDI 180 DS4 HDI 135 DS4 HDI 150 DS4 HDI 180 DS5 HDI 150 DS5 HDI 180 GRAND C4 SPACETOURER HDI 150 GRAND C4 SPACETOURER HDI 160 JUMPY HDI 120 JUMPY HDI 145 JUMPY HDI 150 JUMPY HDI 180 SPACETOURER HDI 120 SPACETOURER HDI 145 SPACETOURER HDI 150 SPACETOURER HDI 180</p>	<p>04/09</p>	<p>02-12453-01</p>	<p>08-12456-01</p>	<p>04-10350-01 </p>	<p>61-10212-00 98 070 922 80 86 Ø 1,25 mm MLS</p> <p>61-10212-10 98 070 923 80 86 Ø 1,3 mm MLS</p> <p>61-10212-20 98 070 924 80 86 Ø 1,35 mm MLS</p> <p>61-10212-30 98 070 925 80 86 Ø 1,4 mm MLS</p>	<p>14-12457-01 98 020 332 80 (10x)</p>	<p>71-12453-00 98 012 929 80</p>	<p>12-38539-01 0956.63 (16x)</p> <p>70-38539-00 0956.63</p>	<p>71-12455-00 </p> <p>98 009 431 80</p> <p>71-12456-00 98 014 448 80</p> <p>81-36557-00 </p> <p>0127.47 42x62 A SL RD PTFE</p> <p>81-36556-00 </p> <p>0127.45 90x110 A SL LD PTFE</p> <p>81-34144-00 </p> <p>0807.28 27x47 A SL RD FPM</p>

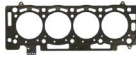
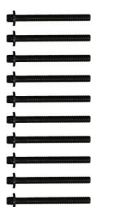
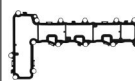
CITROEN













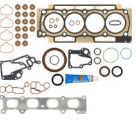

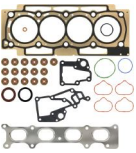



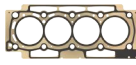



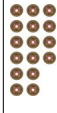

















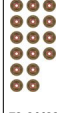

<p>Ltr.  2,0 AHM (DW10FUE) 81 kW (110 PS) JUMPER HDI JUMPER HDI 110 07/15-09/19 </p>		 <p>02-12453-01</p> 	 <p>08-12456-01</p> 		 <p>61-10212-00 98 070 922 80 86 Ø 1,25 mm MLS </p> <p>61-10212-10 98 070 923 80 86 Ø 1,3 mm MLS </p> <p>61-10212-20 98 070 924 80 86 Ø 1,35 mm MLS </p> <p>61-10212-30 98 070 925 80 86 Ø 1,4 mm MLS </p> 	 <p>14-12457-01 98 020 332 80 (10x)</p> 	 <p>71-12453-00 98 012 929 80</p> 	 <p>12-38539-01 0956.63 (16x)</p>  <p>70-38539-00 0956.63 16x</p> 	 <p>71-12455-00  98 009 431 80</p> 	 <p>70-31414-10 </p>  <p>71-12456-00 98 014 448 80</p> 	 <p>81-36557-00  0127.47 42x62 A SL RD PTFE</p>  <p>81-36556-00  0127.45 90x110 A SL LD PTFE</p>  <p>81-34144-00 N 0807.28 27x47 A SL RD FPM</p> 
<p>2,0 AHN (DW10FUD) 96-120 kW (130-163 PS) JUMPER HDI JUMPER HDI 130 JUMPER HDI 160 07/15-09/19</p>		 <p>02-12453-01</p> 	 <p>08-36556-01</p> 		 <p>61-10212-00 98 070 922 80 86 Ø 1,25 mm MLS </p> <p>61-10212-10 98 070 923 80 86 Ø 1,3 mm MLS </p> <p>61-10212-20 98 070 924 80 86 Ø 1,35 mm MLS </p> <p>61-10212-30 98 070 925 80 86 Ø 1,4 mm MLS </p> 	 <p>14-12457-01 98 020 332 80 (10x)</p> 	 <p>71-12453-00 98 012 929 80</p> 	 <p>12-38539-01 0956.63 (16x)</p>  <p>70-38539-00 0956.63 16x</p> 	 <p>71-12455-00  98 009 431 80</p> 	 <p>70-31414-10 </p> 	 <p>81-36557-00  0127.47 42x62 A SL RD PTFE</p>  <p>81-36556-00  0127.45 90x110 A SL LD PTFE</p>  <p>81-34144-00 N 0807.28 27x47 A SL RD FPM</p> 

CITROEN















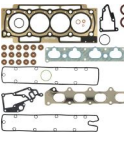



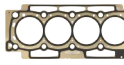





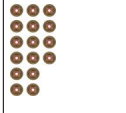











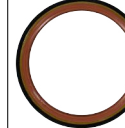

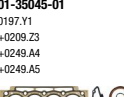
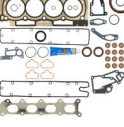

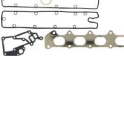



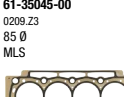

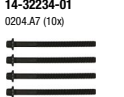

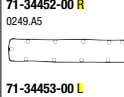
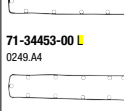

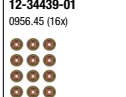





<p>Ltr. </p>													
<p>2,0 AHY (DW10CE) 72-147 kW (98-200 PS) AHZ (DW10CD) RHA (DW10CTED4) RHC (DW10CTED4) RHD (DW10CB) RHD (DW10CTED4) RHE (DW10CDTR) RHE (DW10CTED4) RHH (DW10CTED4)</p>	<p>C4 Grand PICASSO HDI C4 GRAND PICASSO HDI C4 GRAND PICASSO HDI C4 HDI C4 HDI 160 C4 PICASSO HDI C4 PICASSO HDI 135 C5 C5 HDI C5 HDI 140 C5 HDI 150 C5 HDI 165 C8 HDI 135 C8 HDI 165 DS4 HDI 135 DS4 HDI 165 DS5 HDI DS5 HDI 135 DS5 HDI 165 JUMPY HDI 100 JUMPY HDI 125 JUMPY HDI 165 JUMPY HDI 95</p>	<p>03/06</p>	<p>01-42135-01 0197.AW +0249.G8 +0348.V7</p> 	<p>02-42135-01 0197.AX +0348.V7</p> 			<p>61-42135-00 0209.GL 1,25 mm MLS</p> <p>61-42135-10 0209.GN 1,3 mm MLS</p> <p>61-42135-20 0209.GP 1,35 mm MLS</p> <p>61-42135-30 0209.GQ 1,4 mm MLS</p> 	<p>14-35774-01 0204.A6 (10x)</p> 	<p>71-42033-00 0348.V7</p> 	<p>12-38539-01 0956.63 (16x)</p> <p>70-38539-00 0956.63</p> <p>16x</p> 	<p>71-42032-00  0349.N2</p> 	<p>70-31414-10</p> 	<p>81-36557-00 K↔ 0127.47 42x62 A SL RD PTFE</p>  <p>81-36556-00 K↔ 0127.45 90x110 A SL LD PTFE</p>  <p>81-34144-00 N 0807.28 27x47 A SL RD FPM</p> 
<p>2,0 EHZ (DW10FC) 130 kW (177 PS)</p>	<p>C5 AIRCROSS HDI 180</p>	<p>11/18</p>		<p>02-12453-01</p> 	<p>08-12456-01</p> 	<p>04-10350-01 </p> 	<p>61-10212-00 98 070 922 80 86 Ø 1,25 mm MLS</p> <p>61-10212-10 98 070 923 80 86 Ø 1,3 mm MLS</p> <p>61-10212-20 98 070 924 80 86 Ø 1,35 mm MLS</p> <p>61-10212-30 98 070 925 80 86 Ø 1,4 mm MLS</p> 	<p>14-12457-01 98 020 332 80 (10x)</p> 	<p>71-12453-00 98 012 929 80</p> 	<p>12-38539-01 0956.63 (16x)</p> <p>70-38539-00 0956.63</p> <p>16x</p> 	<p>71-12455-00  98 009 431 80</p> 	<p>71-12456-00 98 014 448 80</p> 	<p>81-36557-00 K↔ 0127.47 42x62 A SL RD PTFE</p>  <p>81-36556-00 K↔ 0127.45 90x110 A SL LD PTFE</p> 

CITROEN														
Ltr.														
2,0 RDZ (XU10MZ) RFZ (XU10J2) XU102C	79-89 kW (107-121 PS)	XM	05/89-06/94											
					<p>02-33665-01 0197.C8 +0209.N1</p>	<p>08-25918-04</p>		<p>61-33665-00 0209.N1 87 Ø 1,35 mm</p>	<p>14-32077-01 0204.65 (10x)</p>	<p>71-26237-00 0249.48</p>	<p>12-25837-01 0956.22 (8x)</p> <p>70-25837-00 0956.22</p>	<p>71-33676-00 </p> <p>0348.E0</p> <p>71-26236-10 4x</p> <p>0349.70</p> <p>8x</p>	<p>71-25918-30 0304.34</p>	<p>81-25826-10 </p> <p>0326.12 42x62 A RD FPM</p> <p>81-34456-00 </p> <p>0127.28 90x110 A SL LD FPM</p> <p>81-26244-10 N</p> <p>0236.21 36x50 A RD ACM</p>
2,0 RFH (EW10A)	103 kW (140 PS)	JUMPY	01/07-03/16											
					<p>01-37360-01</p>	<p>02-37360-01</p>	<p>08-41188-01</p>	<p>61-37360-00 0209.FS MLS 10/07</p>	<p>14-32342-01 0204.A3 (10x)</p>		<p>12-34439-01 0956.45 (16x)</p> <p>70-34439-00 0956.45</p>	<p>71-38549-00 4x</p> <p>0348.S2</p> <p>71-34982-00 </p> <p>0349.L4</p> <p>16x</p>	<p>70-31414-10</p>	<p>81-34454-10 </p> <p>16 089 406 80 40x55 A SL RD PTFE</p> <p>81-34456-00 </p> <p>0127.28 90x110 A SL LD FPM</p> <p>81-34403-00 N</p> <p>0236.44 36x50 A SL FPM</p> <p>81-38657-00 N</p> <p>0236.74 39x50 A SL RD PTFE (Polytetrafluorethylen)/ACM (Polyacryl-Kautschuk)</p>





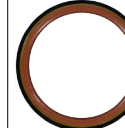













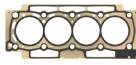





















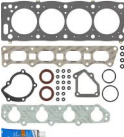







CITROEN

<p>Ltr.  2,0 RFJ (EW10A) 103-111 kW (140-151 PS) C4 C4 GRAND PICASSO 16V C4 PICASSO 16V C4 VTR C4 16V C5 C5 16V C8 C8 16V JUMPY</p> <p>06/04 </p>	<p></p> <p>01-37360-01 </p>	<p></p> <p>02-37360-01 </p>	<p></p> <p>08-41188-01 </p>	<p></p>	<p></p> <p>61-37360-00 0209.FS MLS </p>	<p></p> <p>14-32342-01 0204.A3 (10x) </p>	<p></p>	<p></p> <p>12-34439-01 0956.45 (16x)  70-34439-00 0956.45  16x</p>	<p></p> <p>71-38549-00  4x 0348.S2 71-34992-00  0349.L4</p>	<p></p> <p>70-31414-10 </p>	<p></p> <p>81-34454-10  K 16 089 406 80 40x55 A SL RD PTFE  81-34456-00  K 0127.28 90x110 A SL LD FPM  81-34403-00  N 0236.44 36x50 A SL FPM  81-38657-00  N 0236.74 39x50 A SL RD PTFE (Polytetrafluorethylen)/ACM (Polyacryl-Kautschuk) </p>
<p>2,0 RFK (EW10A) 130 kW (177 PS)</p>					<p>61-35045-00 0209.Z3 85 0 MLS </p>	<p>14-32234-01 0204.A7 (10x) </p>	<p>71-34452-00  AS R 0249.A5 71-34453-00  ES L 0249.A4</p>	<p>12-34439-01 0956.45 (16x)  70-34439-00 0956.45  16x</p>	<p>71-36957-00  0348.H8 71-33853-00  0349.H8</p>	<p>70-31414-10 </p>	<p>81-34454-10  K 16 089 406 80 40x55 A SL RD PTFE  81-34456-00  K 0127.28 90x110 A SL LD FPM  81-34403-00  N 2x 0236.44 36x50 A SL FPM </p>



CITROEN





















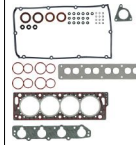

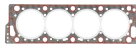

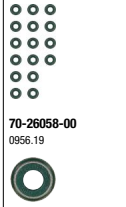

<p>Ltr. </p> <p>2,0 RFK (EW10J4S) 130 kW (177 PS) C4 16V</p> <p>11/04-12/10 </p>	 <p>01-35045-04</p> 	 <p>02-35045-04</p> 	 <p>08-37006-04</p> 		 <p>61-35045-00</p> <p>0209.Z3 85 Ø MLS</p> 	 <p>14-32342-01</p> <p>0204.A3 (10x)</p> 	 <p>71-34452-00 R</p> <p>0249.A5</p>  <p>71-34453-00 L</p> <p>0249.A4</p> 	 <p>12-34439-01</p> <p>0956.45 (16x)</p>  <p>70-34439-00</p> <p>0956.45</p>  <p>16x</p>	 <p>71-36957-00 L </p> <p>0348.R8</p>  <p>71-33853-00 </p> <p>0349.H8</p> 	 <p>70-31414-10</p> 	 <p>81-34454-10 </p> <p>16 089 406 80 40x55 A SL RD PTFE</p>  <p>81-34456-00 </p> <p>0127.28 90x110 A SL LD FPM</p>  <p>81-34403-00 N </p> <p>0236.44 36x50 A SL FPM</p>  <p>2x</p>
<p>2,0 RFN (EW10J4) 88-105 kW (120-143 PS) C4 C4 PICASSO 16V C4 16V C5 16V C8 EVASION 16V JUMPY JUMPY 16V XSARA PICASSO XSARA PICASSO 16V XSARA 16V</p> <p>12/99</p>	 <p>01-35045-01</p> <p>0197.Y1 +0209.Z3 +0249.A4 +0249.A5</p> 	 <p>02-35045-01</p> 	 <p>08-37006-01</p> 		 <p>61-35045-00</p> <p>0209.Z3 85 Ø MLS</p> 	 <p>14-32234-01</p> <p>0204.A7 (10x)</p> 	 <p>71-34452-00 R</p> <p>0249.A5</p>  <p>71-34453-00 L</p> <p>0249.A4</p> 	 <p>12-34439-01</p> <p>0956.45 (16x)</p>  <p>70-34439-00</p> <p>0956.45</p>  <p>16x</p>	 <p>71-35903-00 </p> <p>0348.P1</p>  <p>71-33853-00 </p> <p>0349.H8</p> 	 <p>70-31414-10</p> 	 <p>81-34454-10 </p> <p>16 089 406 80 40x55 A SL RD PTFE</p>  <p>81-34456-00 </p> <p>0127.28 90x110 A SL LD FPM</p>  <p>81-34403-00 N </p> <p>0236.44 36x50 A SL FPM</p>  <p>2x</p>

CITROEN











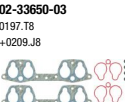

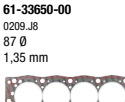

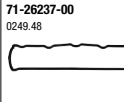
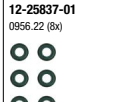



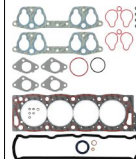

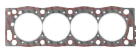

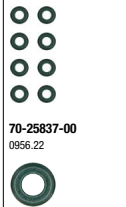

<p>Ltr.  2,0 RFR (EW10A) 100 kW (136 PS)   1</p>					 <p>61-37360-00 0209.FS MLS 10/07</p> 			 <p>12-34439-01 0956.45 (16x)</p>  <p>70-34439-00 0956.45</p> 	 <p>71-38549-00  4x 0348.S2</p>  <p>71-34992-00  0349.L4</p> 	 <p>70-31414-10</p> 	 <p>81-34454-10  K</p> <p>16 089 406 80 40x55 A SL RD PTFE</p>  <p>81-34456-00  K</p> <p>0127.28 90x110 A SL LD FPM</p>  <p>81-34403-00  N</p> <p>0236.44 36x50 A SL FPM</p>  <p>81-38657-00  N</p> <p>0236.74 39x50 A SL RD PTFE (Polytetrafluorethylen)/ACM (Polyacryl-Kautschuk)</p> 
<p>2,0 RFS (XU10J4RS) 120-123 kW (163-167 PS) XSARA XSARA 16V ZX ZX 16V</p>	<p>05/96-03/05</p> <p>01-35050-01 0197.W2 +0209.Z2</p> 	<p>02-35050-01</p> 	<p>08-25918-04</p> 	<p>61-35050-00 0209.Z2 86,5 Ø MLS</p> 	<p>14-32148-01 0204.72 (10x)</p> 	<p>70-31414-10</p> 	<p>12-31306-01</p>  <p>70-31306-00 0956.64</p> 	<p>71-33666-00  K</p> <p>0348.C8</p>  <p>71-34443-00  0349.F4</p> 	<p>70-31414-10</p> 	<p>81-25926-10  K</p> <p>0326.12 42x62 A RD FPM</p>  <p>81-34456-00  K</p> <p>0127.28 90x110 A SL LD FPM</p>  <p>81-34403-00  N 2x</p> <p>0236.44 36x50 A SL FPM</p> 	

CITROEN

Ltr.  2,0 RFT (XU10J4/Z) 110-114 kW (150-155 PS) XANTIA 16V ZX 16V  07/92-01/98 

										
	<p>02-33660-01 0197.G7 +0209.N0</p> 	<p>08-25918-04</p> 		<p>61-33660-00 0209.N0 87,3 Ø 1,35 mm</p> 	<p>14-32148-01 0204.72 (10x)</p> 	<p>71-33668-00 0249.74</p> 	<p>12-26058-03 0956.19 (16x)</p> <p>70-26058-00 0956.19</p> 	<p>71-33666-00 </p> <p>0348.C8</p>  <p>71-33667-00 </p> <p>0349.98</p> 	<p>70-31414-10</p> 	<p>81-25926-10 </p> <p>0326.12 42x62 A RD FPM</p>  <p>81-34456-00 </p> <p>0127.28 90x110 A SL LD FPM</p>  <p>81-26244-10 </p> <p>0236.21 36x50 A RD ACM</p> 























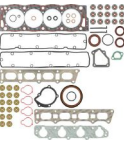

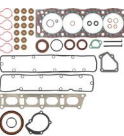

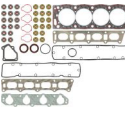

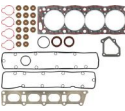
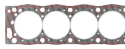























2,0 RFU (XU10J2/C) 89 kW (121 PS) EVASION 06/94-07/02

										
	<p>02-33650-03 0197.J8 +0209.J8</p> 	<p>08-25918-04</p> 		<p>61-33650-00 0209.J8 87 Ø 1,35 mm</p> 	<p>14-32077-01 0204.65 (10x)</p> 	<p>71-26237-00 0249.48</p> 	<p>12-25837-01 0956.22 (8x)</p> <p>70-25837-00 0956.22</p> 	<p>71-34361-00 </p> <p>0348.N0</p>  <p>71-26236-10 </p> <p>0349.70</p> 	<p>70-31414-10</p> 	<p>81-25926-10 </p> <p>0326.12 42x62 A RD FPM</p>  <p>81-34456-00 </p> <p>0127.28 90x110 A SL LD FPM</p>  <p>81-26244-10 </p> <p>0236.21 36x50 A RD ACM</p> 















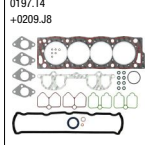



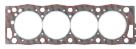



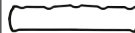

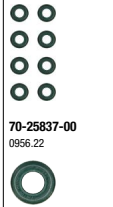















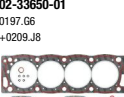
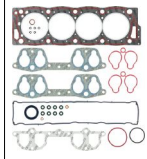

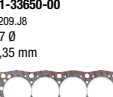
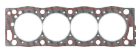

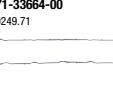

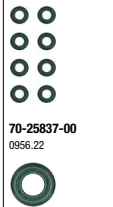

CITROEN

Ltr.  2,0 RFV (XU10J4R) 97-99 kW (132-135 PS) EVASION EVASION 16V XANTIA 16V XM XM 16V XSARA XSARA 16V

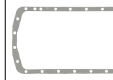





















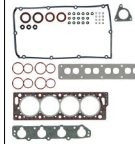

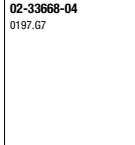





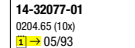



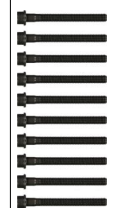

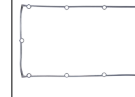



















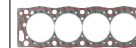

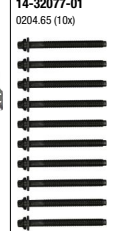









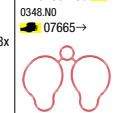

05/89-04/03 

										
<p>01-33650-05 0197.V2 +0209.N6 +0249.A2 +0249.A3  07965</p>  <p>01-33650-06 0197.X8 +0209.N6 +0249.A2 +0249.A3  07966→</p> 	<p>02-33650-05  07965</p>  <p>02-33650-06  07966→</p> 			<p>61-33650-00 0209.J8 87 Ø 1,35 mm</p> 	<p>14-32148-01 0204.72 (10x)</p> 	<p>71-34446-00 R 0249.A3</p>  <p>71-34447-00 L 0249.A2</p> 	<p>12-35257-01 0956.34 (16x)  07359</p>  <p>12-34438-01 0956.42 (16x)  07360→  07965</p>  <p>12-34439-01 0956.45 (16x)  07966→</p>  <p>70-35257-00 0956.34  07359</p>  <p>70-34438-00 0956.42  07360→  07965</p>  <p>70-34439-00 0956.45  07966→</p> 	<p>71-33666-00 I </p> <p>0348.C8</p>  <p>71-35728-00 I  4x</p> <p>0348.L3</p>  <p>71-34443-00 I </p> <p>0349.F4  07664</p>  <p>71-35768-00 I </p> <p>0349.H0  07665→</p> 	<p>70-31414-10</p> 	<p>81-25826-10 K </p> <p>0326.12 42x62 A RD FPM</p>  <p>81-34456-00 K </p> <p>0127.28 90x110 A SL LD FPM</p>  <p>81-34403-00 N 2x</p> <p>0236.44 36x50 A SL FPM</p> 











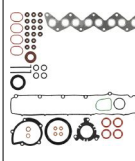
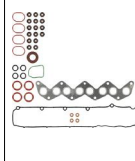



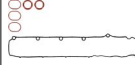
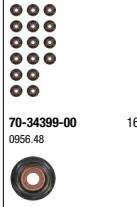







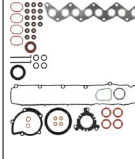
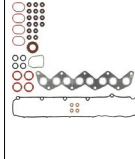

CITROEN

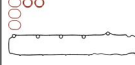
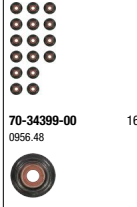
<p>Ltr.  2,0 RFW (XU10J2U) 80 kW (109 PS) JUMPER JUMPER Bus 02/94-04/02 </p>		 <p>02-33650-02 0197.74 +0209.J8</p> 	 <p>08-25918-04</p> 		 <p>61-33650-00 0209.J8 87 Ø 1,35 mm</p> 	 <p>14-32077-01 0204.65 (10x)</p> 	 <p>71-26237-00 0249.48</p> 	 <p>12-25837-01 0956.22 (8x)</p> 	 <p>71-33663-00  2x 0348.F6</p>  <p>71-33738-00   2x 0348.E6</p>  <p>70-25837-00 0956.22</p>  <p>71-26236-10 8x 0349.70</p> 	 <p>70-31414-10</p> 	 <p>81-25926-10  K</p>  <p>0326.12 42x62 A RD FPM</p> <p>81-34456-00  K</p>  <p>0127.28 90x110 A SL LD FPM</p> <p>81-26244-10 N</p>  <p>0236.21 36x50 A RD ACM</p>
<p>2,0 RFX (XU10J2C) 89-95 kW (121-129 PS) XANTIA ZX 07/92-04/03</p>		 <p>02-33650-01 0197.66 +0209.J8</p> 	 <p>08-25918-04</p> 		 <p>61-33650-00 0209.J8 87 Ø 1,35 mm</p> 	 <p>14-32077-01 0204.65 (10x)</p> 	 <p>71-33664-00 0249.71</p> 	 <p>12-25837-01 0956.22 (8x)</p> 	 <p>71-34361-00  2x 0348.N0</p>  <p>71-26236-10 4x 0349.70</p> 	 <p>71-25918-30 0304.34</p> 	 <p>81-25926-10  K</p>  <p>0326.12 42x62 A RD FPM</p> <p>81-34456-00  K</p>  <p>0127.28 90x110 A SL LD FPM</p> <p>81-26244-10 N</p>  <p>0236.21 36x50 A RD ACM</p>















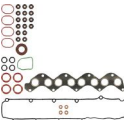







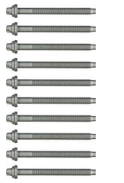

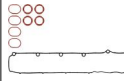

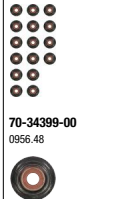













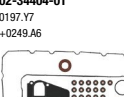
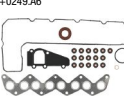





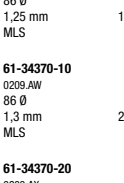

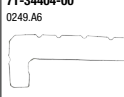

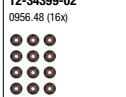
CITROEN

Ltr. 											
2,0 RFY (XU10J4/Z) 112-114 kW (152-155 PS) XANTIA 16V ZX 16V 07/92-01/98 	 02-33660-01 0197.G7 +0209.N0  06/93→  02-33668-04 0197.G7	 08-25918-04		 61-33665-00 0209.N1 87 Ø 1,35 mm  ⇒ 05/93  61-33660-00 0209.N0 87,3 Ø 1,35 mm  06/93→ 	 14-32077-01 0204.65 (10x)  ⇒ 05/93  14-32148-01 0204.72 (10x)  06/93→ 	 71-33668-00 0249.74	 12-26058-03 0956.19 (16x)  70-26058-00 0956.19 16x 	 71-33666-00  0348.C8  71-33667-00  0349.98 	 70-31414-10  	 81-25926-10  0326.12 42x62 A RD FPM  81-34456-00  0127.28 90x110 A SL LD FPM  81-26244-10 N 0236.21 36x50 A RD ACM 	
2,0 RGX (XU10J2TE) 104-108 kW (141-147 PS) EVASION Turbo XANTIA Turbo XM Turbo 09/92-04/03	 02-26237-02 0197.H3 	 08-25918-04		 61-33650-00 0209.J8 87 Ø 1,35 mm 		 71-26237-00 0249.48	 12-25837-01 0956.22 (8x)  70-25837-00 0956.22 8x 	 71-33676-00  0348.E0  ⇒ 07664  71-34361-00  0348.N0  07665→ 	 71-25918-30  0304.34 	 81-25926-10  0326.12 42x62 A RD FPM  81-34456-00  0127.28 90x110 A SL LD FPM  81-22660-00 N 0236.24 32x45 A LD FPM  81-34403-00 N 0236.44 36x50 A SL FPM 	

CITROEN

Ltr.	Image	Image	Image	Image	Image	Image	Image	Image	Image	Image	Image	Image	Image		
2,0	RHF (DW10BTD4)	100-103 kW (136-140 PS)	C4 HDI C5 HDI C5 HDI 140	06/07	<p>01-36571-01 0197.AE +0348.S3</p> 	<p>02-36571-01 0197.AC +0348.S3</p> 		<p>04-10092-01 </p> 	<p>61-34370-00 0209.AV 86 Ø 1,25 mm MLS</p> <p>61-34370-10 0209.AW 86 Ø 1,3 mm MLS</p> <p>61-34370-20 0209.AX 86 Ø 1,35 mm MLS</p> <p>61-34370-30 0209.AY 86 Ø 1,4 mm MLS</p> 	<p>14-35774-01 0204.A6 (10x)</p> 	<p>15-36571-01 0348.S3</p> 	<p>12-34399-02 0956.48 (16x)</p> <p>70-34399-00 0956.48</p> <p>16x</p> 	<p>71-33223-00 </p> <p>0349.J2</p> 	<p>70-31414-10</p> 	<p>81-36557-00 </p> <p>0127.47 42x62 A SL RD PTFE</p>  <p>81-36556-00 </p> <p>0127.45 90x110 A SL LD PTFE</p>  <p>81-34144-00 N</p> <p>0807.28 27x47 A SL RD FPM</p> 
2,0	RHJ (DW10BTD4) RHR (DW10BTD4)	100-101 kW (136-138 PS)	C4 HDI C4 HDI 135 FAP C4 HDI 135 FFAP C4 HDI 138 C5 HDI C8 HDI 135 JUMPY HDI 140	09/04	<p>01-36571-01 0197.AE +0348.S3</p> 	<p>02-36571-01 0197.AC +0348.S3</p> 		<p>04-10061-01 </p> 	<p>61-34370-00 0209.AV 86 Ø 1,25 mm MLS</p> <p>61-34370-10 0209.AW 86 Ø 1,3 mm MLS</p> <p>61-34370-20 0209.AX 86 Ø 1,35 mm MLS</p> <p>61-34370-30 0209.AY 86 Ø 1,4 mm MLS</p> 	<p>14-35774-01 0204.A6 (10x)</p> 	<p>15-36571-01 0348.S3</p> 	<p>12-34399-02 0956.48 (16x)</p> <p>70-34399-00 0956.48</p> <p>16x</p> 	<p>71-33223-00 </p> <p>0349.J2</p> 	<p>70-31414-10</p> 	<p>81-36557-00 </p> <p>0127.47 42x62 A SL RD PTFE</p>  <p>81-36556-00 </p> <p>0127.45 90x110 A SL LD PTFE</p>  <p>81-34144-00 N</p> <p>0807.28 27x47 A SL RD FPM</p> 

CITROEN

<p>Ltr. </p> <p>2,0 RHK (DW10UTED4) 88 kW (120 PS)</p> <p> C8 HDI JUMPY HDI JUMPY HDI 120</p> <p> 07/06</p>		 <p>02-36571-02 0197.AN +0348.S3</p> 		 <p>04-10092-01 </p> 	 <p>61-34370-00 0209.AV 86 Ø 1,25 mm MLS</p> <p>61-34370-10 0209.AW 86 Ø 1,3 mm MLS</p> <p>61-34370-20 0209.AX 86 Ø 1,35 mm MLS</p> <p>61-34370-30 0209.AY 86 Ø 1,4 mm MLS</p> 	 <p>14-35774-01 0204.A6 (10x)</p> 	 <p>15-36571-01 0348.S3</p> 	 <p>12-34399-02 0956.48 (16x)</p> <p>70-34399-00 0956.48 16x</p> 	 <p>71-36124-00  0349.L9</p> 	 <p>70-31414-10</p> 	 <p>81-36557-00  0127.47 42x62 A SL RD PTFE</p>  <p>81-36556-00  0127.45 90x110 A SL LD PTFE</p>  <p>81-34144-00 N 0807.28 27x47 A SL RD FPM</p> 
<p>2,0 RHM (DW10ATED4) 76-81 kW (103-110 PS)</p> <p> C8 HDI EVASION HDI JUMPY HDI 110 JUMPY HDI 110 16V XSARA PICASSO HDI</p> <p>09/99</p>	 <p>01-34404-01 0197.Y6</p> 	 <p>02-34404-01 0197.Y7 +0249.A6</p> 	 <p>04-10074-01 </p> 	 <p>61-34370-00 0209.AV 86 Ø 1,25 mm MLS</p> <p>61-34370-10 0209.AW 86 Ø 1,3 mm MLS</p> <p>61-34370-20 0209.AX 86 Ø 1,35 mm MLS</p> <p>61-34370-30 0209.AY 86 Ø 1,4 mm MLS</p> 	 <p>14-32233-01 0204.96 (10x)</p> 	 <p>71-34404-00 0249.A6</p> 	 <p>12-34399-02 0956.48 (16x)</p> <p>70-34399-00 0956.48 16x</p> 	 <p>71-33223-00  0349.J2</p> 	 <p>70-31414-10</p> 	 <p>81-25926-10  0326.12 42x62 A RD FPM</p>  <p>81-34456-00  0127.28 90x110 A SL LD FPM</p>  <p>81-34144-00 N 0807.28 27x47 A SL RD FPM</p> 	

CITROEN

CITROEN														
2,0	RHS (DW10ATED) RHY (DW10TD) RHZ (DW10ATED)	66-81 kW (90-110 PS)	BERLINGO HDI BERLINGO HDI 90 C4 HDI C5 HDI XANTIA HDI XANTIA HDI 90 XSARA HDI XSARA HDI 109 XSARA HDI 90 XSARA PICASSO HDI	02/99-12/11	01-34398-01 0197.X4 +0249.99 	02-34398-01 0197.X3 +0249.99 	04-10177-01 	61-35815-00 0209.X5 86 Ø 1,3 mm MLS 61-35815-10 0209.X6 86 Ø 1,35 mm MLS 61-35815-20 0209.X7 86 Ø 1,4 mm MLS 61-35815-30 0209.X8 86 Ø 1,45 mm MLS 61-35815-40 0209.X9 86 Ø 1,5 mm MLS 	14-35774-01 0204.A6 (10x) 	71-34398-00 0249.99 	12-31306-07 0956.38 (8x) 08331 12-34399-01 0956.48 (8x) 08332→ 70-31306-00 0956.64 08331 70-34399-00 0956.48 08332→ 	71-34401-00 0348.N4 71-34402-00 0349.H4 	70-31414-10 	81-25826-10 0326.12 42x62 A RD FPM 81-34456-00 0127.28 90x110 A SL LD FPM 81-34144-00 N 0807.28 27x47 A SL RD FPM 81-34456-00 0127.28 90x110 A SL LD FPM 81-34144-00 N 0807.28 27x47 A SL RD FPM
2,0	RHV (DW10TD)	62 kW (84 PS)	JUMPER HDI	11/01-04/02	01-34398-01 0197.X4 +0249.99 	02-34398-01 0197.X3 +0249.99 		61-35815-00 0209.X5 86 Ø 1,3 mm MLS 61-35815-10 0209.X6 86 Ø 1,35 mm MLS 61-35815-20 0209.X7 86 Ø 1,4 mm MLS 61-35815-30 0209.X8 86 Ø 1,45 mm MLS 61-35815-40 0209.X9 86 Ø 1,5 mm MLS 	14-35774-01 0204.A6 (10x) 	71-34398-00 0249.99 	12-34399-01 0956.48 (8x) 70-34399-00 0956.48 	71-34401-00 0348.N4 71-34402-00 0349.H4 	70-31414-10 	81-25826-10 0326.12 42x62 A RD FPM 81-34456-00 0127.28 90x110 A SL LD FPM 81-34144-00 N 0807.28 27x47 A SL RD FPM

CITROEN

Ltr. 1

2,0 RHV (DW10UTD) 62-80 kW (84-109 PS) JUMPER Bus HDI
RHZ (DW10BTED+) JUMPER HDI
JUMPER HDI
JUMPY HDI

01-34398-01
0197.X4
+0249.99

02-34398-01
0197.X3
+0249.99

04-10177-01

61-35815-00
0209.X5
86 Ø
1,3 mm
MLS

61-35815-10
0209.X6
86 Ø
1,35 mm
MLS

61-35815-20
0209.X7
86 Ø
1,4 mm
MLS

61-35815-30
0209.X8
86 Ø
1,45 mm
MLS

61-35815-40
0209.X9
86 Ø
1,5 mm
MLS

14-35774-01
0204.A6 (10x)

71-34398-00
0249.99

12-34399-01
0956.48 (8x)

70-34399-00
0956.48

71-34401-00

0348.N4

71-34402-00

0349.H4

70-31414-10

81-25826-10

0326.12
42x62
A RD FPM

81-34456-00

0127.28
90x110
A SL LD FPM

81-34144-00 **N**

0807.28
27x47
A SL RD FPM

2,0 RHW (DW10ATED4) 80 kW (109 PS) EVASION HDI 16V

01-34404-01
0197.Y6

02-34404-01
0197.Y7
+0249.A6

61-34370-00
0209.AV
86 Ø
1,25 mm
MLS

61-34370-10
0209.AW
86 Ø
1,3 mm
MLS

61-34370-20
0209.AX
86 Ø
1,35 mm
MLS

61-34370-30
0209.AY
86 Ø
1,4 mm
MLS

14-32233-01
0204.96 (10x)

71-34404-00
0249.A6

12-34399-02
0956.48 (16x)

70-34399-00
0956.48

71-33223-00

0349.J2

70-31414-10

81-25826-10

0326.12
42x62
A RD FPM

81-34456-00

0127.28
90x110
A SL LD FPM

81-34144-00 **N**

0807.28
27x47
A SL RD FPM

CITROEN

Ltr.   

2,0 RHX (DW10BTD) 69 kW (94 PS) JUMPY HDI 10/99-10/06



01-34398-01
0197.X4
+0249.99

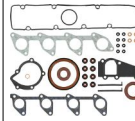

02-34398-01
0197.X3
+0249.99

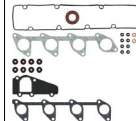

61-35815-00
0209.X5
86 Ø
1,3 mm
MLS

61-35815-10
0209.X6
86 Ø
1,35 mm
MLS

61-35815-20
0209.X7
86 Ø
1,4 mm
MLS

61-35815-30
0209.X8
86 Ø
1,45 mm
MLS

61-35815-40
0209.X9
86 Ø
1,5 mm
MLS



14-35774-01
0204.A6 (10x)



71-34398-00
0249.99



12-31306-07
0956.38 (8x)
08331



12-34399-01
0956.48 (8x)
08332→



70-31306-00
0956.64
08331



70-34399-00
0956.48
08332→

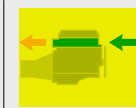

71-34401-00 
0348.N4



71-34402-00 
0349.H4



70-31414-10



81-25826-10 
0326.12
42x62
A RD FPM



81-34456-00 
0127.28
90x110
A SL LD FPM

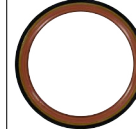

81-34144-00 **N**
0807.28
27x47
A SL RD FPM



2,0 RHZ (DW10ATED) 80 kW (109 PS) EVASION HDI XANTIA HDI 109 02/99-04/03

01-34398-01
0197.X4
+0249.99

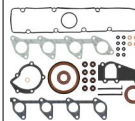

02-34398-01
0197.X3
+0249.99



04-10175-01 



61-35815-00
0209.X5
86 Ø
1,3 mm
MLS

61-35815-10
0209.X6
86 Ø
1,35 mm
MLS

61-35815-20
0209.X7
86 Ø
1,4 mm
MLS

61-35815-30
0209.X8
86 Ø
1,45 mm
MLS

61-35815-40
0209.X9
86 Ø
1,5 mm
MLS



14-35774-01
0204.A6 (10x)



71-34398-00
0249.99



12-31306-07
0956.38 (8x)
08331



12-34399-01
0956.48 (8x)
08332→



70-31306-00
0956.64
08331



70-34399-00
0956.48
08332→



71-34401-00 
0348.N4



71-34402-00 
0349.H4



70-31414-10



81-25826-10 
0326.12
42x62
A RD FPM



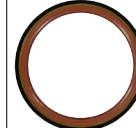

81-34456-00 
0127.28
90x110
A SL LD FPM





















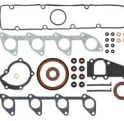
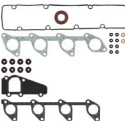







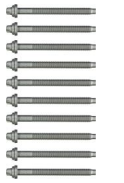











81-34144-00 **N**
0807.28
27x47
A SL RD FPM

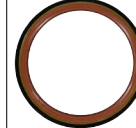

CITROEN

Ltr.  2,0 RHZ (DW10ATED) 80-81 kW (109-110 PS) C4 HDI EVASION HDI JUMPY HDI  08/99-07/08 















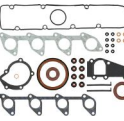

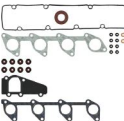









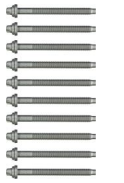

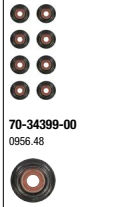











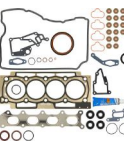
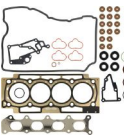

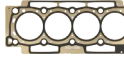

										
<p>01-34398-01 0197.X4 +0249.99</p> 	<p>02-34398-01 0197.X3 +0249.99</p> 		<p>04-10074-01 </p> 	<p>61-35815-00 0209.X5 86 Ø 1,3 mm MLS </p> <p>61-35815-10 0209.X6 86 Ø 1,35 mm MLS </p> <p>61-35815-20 0209.X7 86 Ø 1,4 mm MLS </p> <p>61-35815-30 0209.X8 86 Ø 1,45 mm MLS </p> <p>61-35815-40 0209.X9 86 Ø 1,5 mm MLS </p> 	<p>14-35774-01 0204.A6 (10x)</p> 	<p>71-34398-00 0249.99</p> 	<p>12-31306-07 0956.38 (8x)  08331</p>  <p>12-34399-01 0956.48 (8x)  08332→</p>  <p>70-31306-00 0956.64  08331</p>  <p>70-34399-00 0956.48  08332→</p> 	<p>71-34401-00 </p> <p>0348.N4</p>  <p>71-34402-00 </p> <p>0349.H4</p> 	<p>70-31414-10</p>  	<p>81-25826-10 </p> <p>0326.12 42x62 A RD FPM</p>  <p>81-34456-00 </p> <p>0127.28 90x110 A SL LD FPM</p>  <p>81-34144-00 </p> <p>0807.28 27x47 A SL RD FPM</p> 

CITROEN















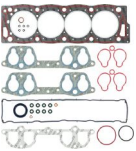



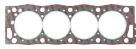



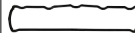

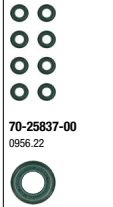

















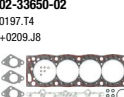
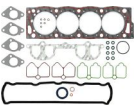



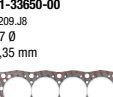
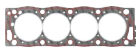

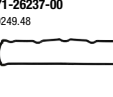

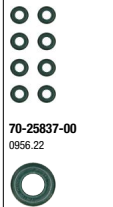





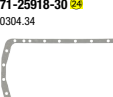

Ltr. 2,0 RHZ (DW10BTEd) 80 kW (109 PS) JUMPY HDI 10/01-10/06

01-34398-01 0197.X4 +0249.99	02-34398-01 0197.X3 +0249.99		04-10177-01	61-35815-00 0209.X5 86 Ø 1,3 mm MLS	14-35774-01 0204.A6 (10x)	71-34398-00 0249.99	12-34399-01 0956.48 (8x)	71-34401-00 0348.N4	70-31414-10 	81-25826-10 0326.12 42x62 A RD FPM → 10052		81-36557-00 0127.47 42x62 A SL RD PTFE → 10053 →
				61-35815-10 0209.X6 86 Ø 1,35 mm MLS			70-34399-00 0956.48	71-34402-00 0349.H4		81-36557-00 0127.47 42x62 A SL RD PTFE → 10053 →		81-34456-00 0127.28 90x110 A SL LD FPM → 10052
				61-35815-20 0209.X7 86 Ø 1,4 mm MLS								81-36556-00 0127.45 90x110 A SL LD PTFE → 10053 →
				61-35815-30 0209.X8 86 Ø 1,45 mm MLS								81-34144-00 N 0807.28 27x47 A SL RD FPM
				61-35815-40 0209.X9 86 Ø 1,5 mm MLS								















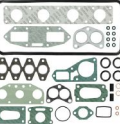



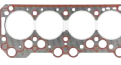



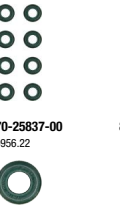















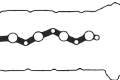













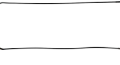

CITROEN

<p>Ltr.   </p> <p>2,0 RHZ (DW10CTED) 80 kW (109 PS) JUMPY HDI 10/01-10/06</p>	 <p>01-34398-01 0197.X4 +0249.99</p> 	 <p>02-34398-01 0197.X3 +0249.99</p> 		 <p>04-10177-01 </p> 	<p>61-35815-00 0209.X5 86 Ø 1,3 mm MLS </p> <p>61-35815-10 0209.X6 86 Ø 1,35 mm MLS </p> <p>61-35815-20 0209.X7 86 Ø 1,4 mm MLS </p> <p>61-35815-30 0209.X8 86 Ø 1,45 mm MLS </p> <p>61-35815-40 0209.X9 86 Ø 1,5 mm MLS </p> 	<p>14-35774-01 0204.A6 (10x)</p> 	<p>71-34398-00 0249.99</p> 	<p>12-34399-01 0956.48 (8x)</p> <p>70-34399-00 0956.48</p> 	<p>71-34401-00 </p> <p>0348.N4</p>  <p>71-34402-00 </p> <p>0349.H4</p> 	<p>70-31414-10</p> 	<p>81-25826-10 </p> <p>0326.12 42x62 A RD FPM  10052</p>  <p>81-34456-00 </p> <p>0127.28 90x110 A SL LD FPM  10052</p>  <p>81-34144-00 N</p> <p>0807.28 27x47 A SL RD FPM</p> 
<p>2,0 RLZ (EW10D) 103 kW (140 PS) C5 16V C5 16V HPI 03/01-08/04</p>	<p>01-35045-02 0197.Y1 +0209.Z3 +0249.A8 +0249.A7 (4x)</p> 	<p>02-35045-02</p> 	<p>08-37006-01</p> 	<p>61-35045-00 0209.Z3 85 Ø MLS</p> 	<p>14-32234-01 0204.A7 (10x)</p> 	<p>71-36967-00 0249.A8</p> 	<p>12-34439-01 0956.45 (16x)</p> <p>70-34439-00 0956.45</p> 	<p>71-33853-00 </p> <p>0349.H8</p> 	<p>70-31414-10</p> 	<p>81-34454-10 </p> <p>16 089 406 80 40x55 A SL RD PTFE</p>  <p>81-34456-00 </p> <p>0127.28 90x110 A SL LD FPM</p>  <p>81-34403-00 N</p> <p>0236.44 36x50 A SL FPM</p>  <p>81-36966-00 N</p> <p>0236.65 39x50 A SL RD FPM</p> 	

CITROEN

<p>Ltr.  R6A</p> <p>94 kW (128 PS)</p> <p>XM</p> <p>05/89-06/94 </p>		 <p>02-33650-01 0197.G6 +0209.J8  03/94</p> 	 <p>08-25918-04</p> 		 <p>61-33650-00 0209.J8 87 Ø 1,35 mm</p> 	 <p>14-32077-01 0204.65 (10x)</p> 	 <p>71-26237-00 0249.48</p> 	 <p>12-25837-01 0956.22 (8x)</p> 	 <p>71-31379-10   0349.91</p>  <p>71-26236-10  4x 0349.70</p>  <p>8x</p>	 <p>71-25918-30  0304.34  09/93</p> 	 <p>81-25926-10  0326.12 42x62 A RD FPM</p>  <p>81-34456-00  0127.28 90x110 A SL LD FPM</p>  <p>81-26244-10 N 0236.21 36x50 A RD ACM</p> 
<p>2,0 XU10J2</p> <p>81-89 kW (110-121 PS)</p> <p>JUMPER JUMPER Bus XM</p> <p>08/94-06/06</p>		 <p>02-33650-02 0197.T4 +0209.J8</p> 	 <p>08-25918-04</p> 		 <p>61-33650-00 0209.J8 87 Ø 1,35 mm</p> 	 <p>14-32077-01 0204.65 (10x)</p> 	 <p>71-26237-00 0249.48</p> 	 <p>12-25837-01 0956.22 (8x)</p> 	 <p>71-33663-00   2x 0348.F6</p>  <p>71-33738-00   2x 0348.E6</p>  <p>71-26236-10  4x 0349.70</p>  <p>8x</p>	 <p>71-25918-30  0304.34</p> 	 <p>81-25926-10  0326.12 42x62 A RD FPM</p>  <p>81-34456-00  0127.28 90x110 A SL LD FPM</p>  <p>81-34403-00 N 0236.44 36x50 A SL FPM</p> 

CITROEN

<p>Ltr.   </p> <p>2,0 170A (XN1T) 57-62 kW (78-84 PS) C25 09/81-03/94</p> <p>170B (XN1T) 170C (XN1T)</p>		 <p>02-19231-01</p>  <p>02-22770-10</p> 			 <p>61-22770-40 90 Ø 1,2 mm</p> 		 <p>71-19231-00 0249.14</p> 	 <p>12-25837-01 0956.22 (8x)</p>  <p>70-25837-00 0956.22</p> 	 <p>71-24661-10 </p>  <p>71-17538-10 </p>  <p>8x</p>	 <p>71-12921-20 0304.44</p> 	 <p>81-25826-10 </p>  <p>0326.12 42x62 A RD FPM</p> 
<p>2,0 4B11 108-110 kW (147-150 PS) C-CROSSER C4 AIRCROSS 11/10</p>	 <p>01-54035-02 16 082 621 80</p>				<p>61-54035-00 16 082 325 80 87 Ø 0,5 mm</p> 	<p>14-12679-01 0204.E3 (8X) +0204.E2 (2X)</p> 	<p>71-54092-00 0249.F9</p> 	<p>12-54093-01 0956.61 (16x)</p>  <p>70-54093-00 0956.61</p>  <p>16x</p>	<p>71-54094-00 </p>  <p>0348.V9</p> <p>71-12676-00 </p>  <p>16 082 604 80</p> <p>4x</p>	 <p>70-31414-10</p> 	<p>81-54097-00 </p>  <p>0127.57 42x55 A SL RD FPM</p> <p>81-54098-00 </p>  <p>0127.51 85x103 A SL LD FPM</p> 
<p>2,0 829A5 78 kW (106 PS) CX 20 CX 20 RE CX 2000 06/79-12/92</p>							<p>71-24461-00 7700 614 729</p> 	<p>12-25837-01 0956.22 (8x)</p>  <p>70-25837-00 0956.22</p>  <p>8x</p>	<p>71-24462-30 </p>  <p>7700 616 523</p> <p>4x</p>		<p>81-16737-20 </p>  <p>50x68 A SL RD FPM</p> <p>81-15855-40 </p>  <p>0236.09 35x47 A RD FPM</p> <p>81-20745-30 </p>  <p>90x110 A SL LD FPM</p> 

CITROEN

Ltr.   
 2,1 PHZ (XUD11ATE) 80 kW (109 PS) EVASION TD XANTIA TD 12V XM TD 12V
 PJZ (XUD11ATE) P8A (XUD11ATE) P8C (XUD11BTE)
 05/89-07/02

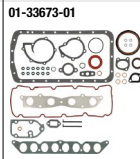

01-33673-01
 0209.R4
 86 Ø
 1,52 mm
 MLS

61-33655-10
 0209.R5
 86 Ø
 1,57 mm
 MLS

61-33655-20
 0209.R6
 86 Ø
 1,62 mm
 MLS

61-33655-30
 0209.R7
 86 Ø
 1,67 mm
 MLS

61-33655-40
 0209.R8
 86 Ø
 1,72 mm
 MLS

61-33655-50
 0209.T4
 86 Ø
 1,77 mm
 MLS

61-33655-60
 0209.T6
 86 Ø
 1,35 mm
 MLS

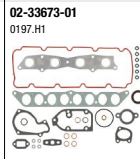
02-33673-01
 0197.H1

08-25918-03

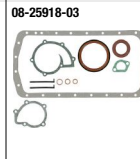
14-32158-01
 0204.99 (10x)

61-33655-00
 0209.R4
 86 Ø
 1,52 mm
 MLS

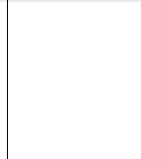
61-33655-10
 0209.R5
 86 Ø
 1,57 mm
 MLS

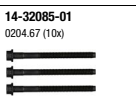
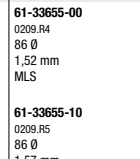
61-33655-20
 0209.R6
 86 Ø
 1,62 mm
 MLS

61-33655-30
 0209.R7
 86 Ø
 1,67 mm
 MLS

61-33655-40
 0209.R8
 86 Ø
 1,72 mm
 MLS

61-33655-50
 0209.T4
 86 Ø
 1,77 mm
 MLS

61-33655-60
 0209.T6
 86 Ø
 1,35 mm
 MLS

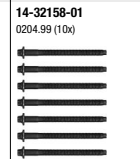
14-32158-01
 0204.99 (10x)



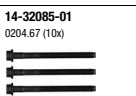
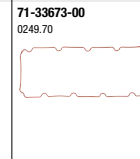

71-33673-00
 0249.70

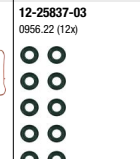
12-25837-03
 0956.22 (12x)

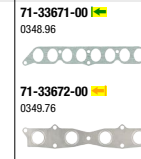
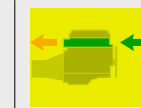
71-33671-00 
 0348.96

71-33672-00 
 0349.76

70-25837-00 12x
 0956.22



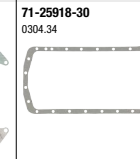

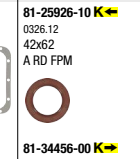
71-25918-30
 0304.34





81-25926-10 
 0326.12
 42x62
 A RD FPM

81-34456-00 
 0127.28
 90x110
 A SL LD FPM



81-21798-30 **N**
 0236.14
 35x50
 A SL WD ACM



2,1 P9A (XUD11A) 60 kW (82 PS) XM XM D 12V
 05/89-08/96

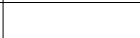

02-33673-01
 0197.H1

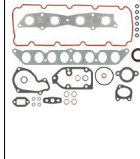
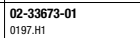
08-25918-03



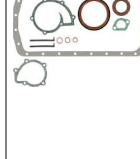
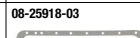

61-27540-00
 0209.H1
 87 Ø
 1,5 mm

61-27540-10
 0209.99
 87 Ø
 1,6 mm

61-27540-20
 0209.A0
 87 Ø
 1,7 mm

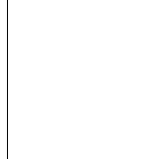
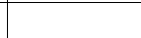
61-27540-30
 0209.H3
 87 Ø
 1,8 mm

14-32085-01
 0204.67 (10x)



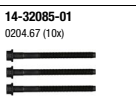
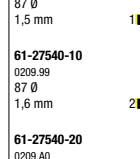
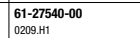

61-27540-00
 0209.H1
 87 Ø
 1,5 mm

61-27540-10
 0209.99
 87 Ø
 1,6 mm

61-27540-20
 0209.A0
 87 Ø
 1,7 mm

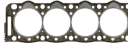
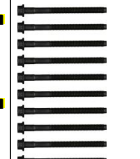
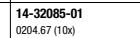
61-27540-30
 0209.H3
 87 Ø
 1,8 mm

14-32085-01
 0204.67 (10x)



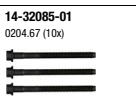
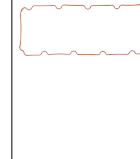
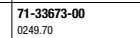

71-33673-00
 0249.70

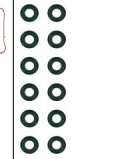
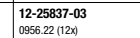
12-25837-03
 0956.22 (12x)

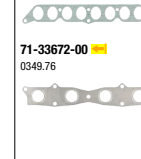
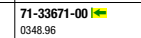
71-33671-00 
 0348.96

71-33672-00 
 0349.76

70-25837-00 12x
 0956.22



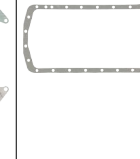
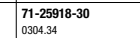

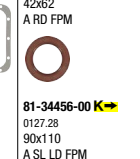
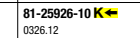
71-25918-30
 0304.34





81-25926-10 
 0326.12
 42x62
 A RD FPM





















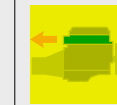





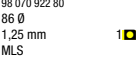

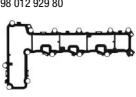
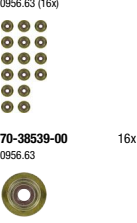









81-34456-00 
 0127.28
 90x110
 A SL LD FPM



81-21798-30 **N** 2x
 0236.14
 35x50
 A SL WD ACM

















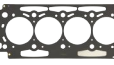



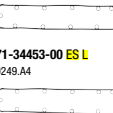





CITROEN











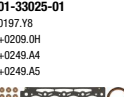



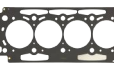
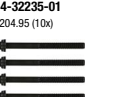

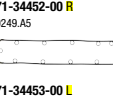
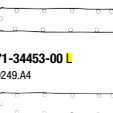

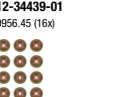

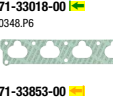
Ltr.														
2.2	BNF (DW12RUD) 4HA (DW12RUE) 4HH (DW12RUC) 4HJ (DW12RUD) 4HK (DW12RUE)	88-121 kW (120-165 PS)	08/19											
	JUMPER Bus HDI 120 JUMPER Bus HDI 140 JUMPER Bus HDI 165 JUMPER HDI 120 JUMPER HDI 140 JUMPER HDI 165			02-12453-01	08-12456-01	04-10350-01 	61-10212-00 98 070 922 80 86 Ø 1,25 mm MLS 61-10212-10 98 070 923 80 86 Ø 1,3 mm MLS 61-10212-20 98 070 924 80 86 Ø 1,35 mm MLS 61-10212-30 98 070 925 80 86 Ø 1,4 mm MLS	14-12457-01 98 020 332 80 (10x)	71-12453-00 98 012 929 80	12-38539-01 0956.63 (16x)	71-12455-00  98 009 431 80	70-31414-10  71-12456-00 98 014 448 80	81-36557-00  0127.47 42x62 A SL RD PTFE 81-36556-00  0127.45 90x110 A SL LD PTFE 81-34144-00  0807.28 27x47 A SL RD FPM	
2.2	B22/615	45 kW (61 PS)	11/73-01/80						71-31131-00 5 450 155	70-20423-00  AS 4x	50-92221-20  0348.H0	71-25639-10  0349.F0		
									71-24461-00 7700 614 729	12-25837-01 0956.22 (8x)	71-24462-30  7700 616 523			81-16737-20   50x68 A SL RD FPM 81-15855-40  0236.09 35x47 A RD FPM 81-20745-30  90x110 A SL LD FPM
2.2	J6T A500	83-85 kW (113-115 PS)	06/81-12/92		08-24008-02 									

CITROEN





























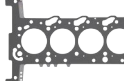

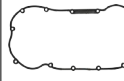
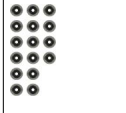













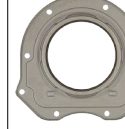

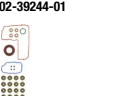



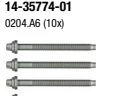
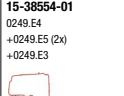



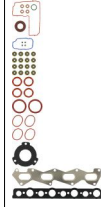



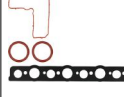





















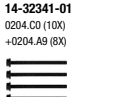
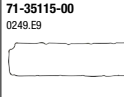
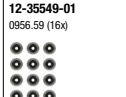

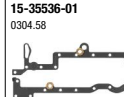

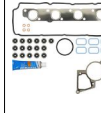
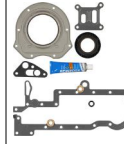



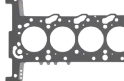





Ltr.   
 2,2 3FY (EW12J4) 120 kW (163 PS)

 01-33025-01 0197.Y8 +0209.0H +0249.A4 +0249.A5 	 02-33025-01 			 61-33025-00 0209.0H 87 0 MLS 	 14-32235-01 0204.95 (10x) 	 71-34452-00 AS R 0249.A5  71-34453-00 ES L 0249.A4 	 12-34439-01 0956.45 (16x)  70-34439-00 0956.45 	 71-33018-00 I 0348.P6  71-33853-00 0349.H8 	 70-31414-10 	 81-34454-10 K 16 089 406 80 40x55 A SL RD PTFE  81-34456-00 K 0127.28 90x110 A SL LD FPM  81-34403-00 N 0236.44 36x50 A SL FPM  81-36966-00 N 0236.65 39x50 A SL RD FPM 
--	---	---	--	---	--	--	--	--	---	---



2,2 3FZ (EW12J4) 116 kW (158 PS) C8 07/02

 01-33025-01 0197.Y8 +0209.0H +0249.A4 +0249.A5 	 02-33025-01 			 61-33025-00 0209.0H 87 0 MLS 	 14-32235-01 0204.95 (10x) 	 71-34452-00 R 0249.A5  71-34453-00 L 0249.A4 	 12-34439-01 0956.45 (16x)  70-34439-00 0956.45 	 71-33018-00 I 0348.P6  71-33853-00 0349.H8 	 70-31414-10 	 81-34454-10 K 16 089 406 80 40x55 A SL RD PTFE  81-34456-00 K 0127.28 90x110 A SL LD FPM  81-34403-00 N 0236.44 36x50 A SL FPM  81-36966-00 N 0236.65 39x50 A SL RD FPM 
--	--	--	--	--	--	---	---	---	--	--

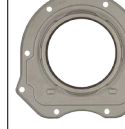
CITROEN

<p>Ltr. </p> <p>2.2 4HG (PUMA C) 4HG (P22DTE) 4HH (PUMA C) 4HH (P22DTE) 4HJ (PUMA C) 4HJ (P22DTE)</p> <p>81-110 kW (110-150 PS)</p> <p>JUMPER Bus HDI JUMPER HDI 110 JUMPER HDI 130 JUMPER HDI 150</p> <p> 07/11</p>           				<p>04-10369-01 </p>    	<p>61-37365-00 0209.EH 87,5 Ø 1,1 mm MLS</p> <p>61-37365-10 0209.ES 87,5 Ø 1,15 mm MLS</p> <p>61-37365-20 0209.ET 87,5 Ø 1,2 mm MLS</p> 	<p>14-32341-01 0204.C0 (10X) +0204.A9 (8X)</p> 	<p>71-42374-00 96 777 474 80</p> 	<p>12-35549-01 0956.59 (16x)</p> <p>70-35549-00 0956.59</p>  	<p>71-35539-00  8x 0348.T1</p>  <p>71-33894-00  0349.L5</p>  <p>71-36016-00   0349.P1</p> 	<p>15-35536-01 0304.58</p>  <p>70-31414-10</p> 	<p>81-90014-00  0514.C6 PTFE</p>  <p>81-90013-00  0514.C4 PTFE</p> 
<p>2.2 4HK (DW12ME5) 4HL (DW12C) 4HN (DW12MTED4) 4HP (DW12BTED4) 4HR (DW12BTED4) 4HS (DW12BTED4) 4HT (DW12BTED4)</p> <p>115-150 kW (156-204 PS)</p> <p>C-CROSSER HDI C5 HDI C5 HDI 165 C5 HDI 200 C6 HDI C8 HDI</p> <p>04/06</p>           	<p>02-39244-01</p> 	<p>08-39246-01</p>  	<p>61-35805-00 0209.FT 85,9 Ø 1,25 mm MLS</p> <p>61-35805-10 0209.FV 85,9 Ø 1,3 mm MLS</p> <p>61-35805-20 0209.FW 85,9 Ø 1,35 mm MLS</p> <p>61-35805-30 0209.FX 85,9 Ø 1,4 mm MLS</p> 	<p>14-35774-01 0204.A6 (10x)</p> 	<p>15-38554-01 0249.E4 +0249.E5 (2x) +0249.E3</p>  <p>71-38552-00 0249.E5</p>  <p>71-38554-00 0249.E4</p> 	<p>12-38539-01 0956.63 (16x)</p> <p>70-38539-00 0956.63</p>  	<p>11-38553-01  0348.T2</p>     <p>71-35919-00  0349.P1</p> 	<p>70-31414-10</p> 	<p>81-36557-00  0127.47 42x62 A SL RD PTFE</p>  <p>81-36556-00  0127.45 90x110 A SL LD PTFE</p>  <p>81-34144-00 N 0807.28 27x47 A SL RD FPM</p> 		
<p>2.2 4HU (P22DTE) 4HV (P22DTE)</p> <p>74-88 kW (101-120 PS)</p> <p>JUMPER HDI 100 JUMPER HDI 120</p> <p>04/06</p>           	<p>02-35115-04</p> 	<p>08-35536-01</p> 	<p>04-10217-01 </p>   	<p>61-37365-00 0209.EH 87,5 Ø 1,1 mm MLS</p> <p>61-37365-10 0209.ES 87,5 Ø 1,15 mm MLS</p> <p>61-37365-20 0209.ET 87,5 Ø 1,2 mm MLS</p> 	<p>14-32341-01 0204.C0 (10X) +0204.A9 (8X)</p> 	<p>71-35115-00 0249.E9</p> 	<p>12-35549-01 0956.59 (16x)</p> <p>70-35549-00 0956.59</p>  	<p>71-35539-00  8x 0348.T1</p>  <p>71-33894-00  0349.L5</p>  <p>71-36016-00   0349.P1</p> 	<p>15-35536-01 0304.58</p>  <p>70-31414-10</p> 	<p>81-90014-00  0514.C6 PTFE</p>  <p>81-90013-00  0514.C4 PTFE</p> 	

CITROEN

Ltr.   
 2.2 4HW (DW12TED4) 94 kW (128 PS) C8 HDI 07/02



01-34404-01
0197.Y6



02-34404-01
0197.Y7
+0249.A6

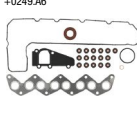

04-10101-01 



61-34370-00

0209.AV
86 Ø
1,25 mm
MLS



61-34370-10
0209.AW
86 Ø
1,3 mm
MLS



61-34370-20
0209.AX
86 Ø
1,35 mm
MLS



61-34370-30
0209.AY
86 Ø
1,4 mm
MLS



14-35774-01

0204.A6 (10x)

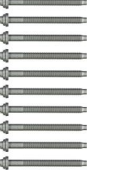

71-34404-00

0249.A6



12-34399-02

0956.48 (16x)

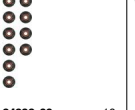

70-34399-00
0956.48

16x



71-33223-00 

0349.J2



70-31414-10

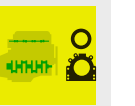

81-25926-10 

0326.12
42x62
A RD FPM



81-34456-00 

0127.28
90x110
A SL LD FPM

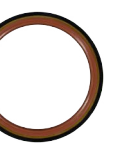

81-34144-00 **N**

0807.28
27x47
A SL RD FPM





2.2 4HW (DW12TED4) 98 kW (133 PS) C5 HDI 03/01

01-34404-01
0197.Y6

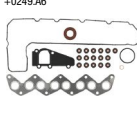

02-34404-01
0197.Y7
+0249.A6



04-10211-01 



61-34370-00

0209.AV
86 Ø
1,25 mm
MLS



61-34370-10
0209.AW
86 Ø
1,3 mm
MLS



61-34370-20
0209.AX
86 Ø
1,35 mm
MLS



61-34370-30
0209.AY
86 Ø
1,4 mm
MLS



14-35774-01

0204.A6 (10x)

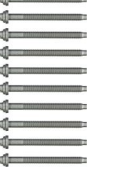

71-34404-00

0249.A6



12-34399-02

0956.48 (16x)



70-34399-00
0956.48

16x



71-33223-00 

0349.J2



70-31414-10



81-25926-10 

0326.12
42x62
A RD FPM

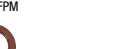

81-34456-00 

0127.28
90x110
A SL LD FPM

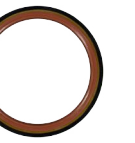























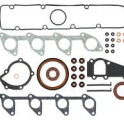
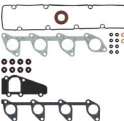









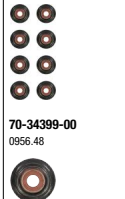













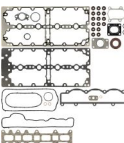
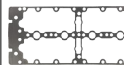



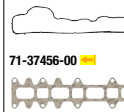





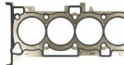
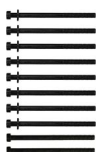

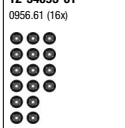









81-34144-00 **N**



















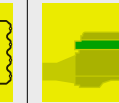
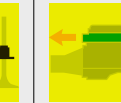
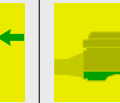











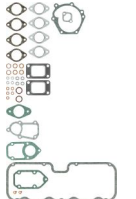
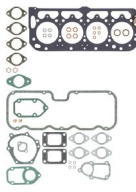

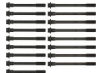
0807.28
27x47
A SL RD FPM















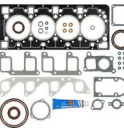

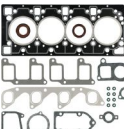





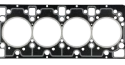





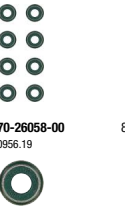



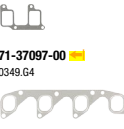









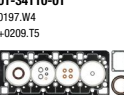
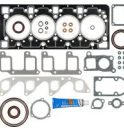
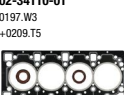
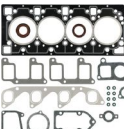

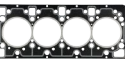
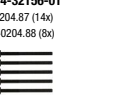

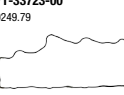

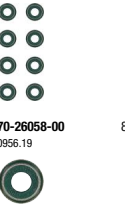

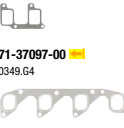

CITROEN

<p>Ltr. </p>	<p>2.2 4HY (DW12UTED) 74 kW (101 PS)</p>	<p> JUMPER Bus HDI JUMPER HDI</p>	<p> 04/02-06/06</p>											
<p>01-34398-01 0197.X4 +0249.99</p> 	<p>02-34398-01 0197.X3 +0249.99</p> 		<p>04-10175-01 </p> 	<p>61-33875-00 0209.AQ 86 Ø 1,25 mm MLS </p> <p>61-33875-10 0209.AR 86 Ø 1,3 mm MLS </p> <p>61-33875-20 0209.AS 86 Ø 1,35 mm MLS </p> <p>61-33875-30 0209.AT 86 Ø 1,4 mm MLS </p> 	<p>14-32233-01 0204.96 (10x)</p> 	<p>71-34398-00 0249.99</p> 	<p>12-34399-01 0956.48 (8x)</p> 	<p>71-34401-00 </p> <p>0348.N4</p>  <p>71-34402-00 </p> <p>0349.H4</p>  <p>8x</p>	<p>70-34399-00 0956.48</p> 	<p>70-31414-10</p> 	<p>81-25826-10 </p> <p>0326.12 42x62 A RD FPM</p>  <p>81-34456-00 </p> <p>0127.28 90x110 A SL LD FPM</p>  <p>81-34144-00 </p> <p>0807.28 27x47 A SL RD FPM</p> 			
<p>2.3 F1AE0481T 93 kW (126-127 PS) JUMPER HDI 08/08</p>	<p>61-37080-00 88,5 Ø 1,1 mm MLS</p> <p>61-37080-10 88,5 Ø 1,2 mm MLS</p> <p>61-37080-20 88,5 Ø 1,3 mm MLS</p> 	<p>02-37551-01</p> 				<p>71-37453-00</p> 	<p>70-38209-00</p> 	<p>71-10040-00 </p> <p>71-37456-00 </p> 	<p>71-37549-00</p> 	<p>81-37601-00 </p> <p>50x80</p>  <p>81-37602-10 </p> <p>83x113 FPM</p> 				
<p>2.4 SFZ (4B12 MMC) 4B12 125 kW (170 PS) C-CROSSER C-CROSSER 16V 08/08</p>	<p>01-10239-01 0197.CA</p> 			<p>61-10239-00 0209.FN 89 Ø 0,5 mm MLS</p> 	<p>14-12679-01 0204.E3 (8x) +0204.E2 (2x)</p> 	<p>71-54092-00 0249.F9</p> 	<p>12-54093-01 0956.61 (16x)</p> 	<p>71-54094-00 </p> <p>0348.V9</p>  <p>71-54096-00 </p> <p>0349.N1</p>  <p>16x</p>	<p>70-31414-10</p> 	<p>81-54097-00 </p> <p>0127.57 42x55 A SL RD FPM</p>  <p>81-54098-00 </p> <p>0127.51 85x103 A SL LD FPM</p> 				
<p>2.5 B25/637 51 kW (69 PS) C35 D 02/80-01/94</p>					<p>14-32080-01 0204.41 (8x) +0204.42 (8x)</p> 	<p>71-25612-20 0249.78</p> 	<p>70-20423-00 </p> <p>4x</p>  <p>70-23062-00 </p> <p>ES</p> <p>4x</p> <p>5 403 212</p> 	<p>71-25639-10 </p> <p>4x</p> <p>0349.F0</p> 						

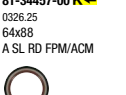

CITROEN

Ltr.													
2,5	CRD93L (U25/661) M25-629 M25-659 M25-660	54-100 kW (73-136 PS)	CX 25 D CX 25 TRI CX 25 TRI CX 2500 D C25 D	02/78-07/94	<p>02-24960-03</p>  <p>02-24960-04 0197.K1 +0209.L5</p> 	<p>61-24960-10 0209.L5 95,5 Ø 1,5 mm</p> 	<p>14-32080-01 0204.41 (8x) +0204.42 (8x)</p> 	<p>71-31131-00 5 450 155</p> 	<p>12-23062-01 5 403 212 (8x)</p>  <p>70-23062-00 5 403 212</p> 	<p>50-92221-20  4x 0348.H0</p>  <p>71-25639-10  4x 0349.F0</p>  <p>8x</p>			
2,5	CRD93LS (U25/673) M25-648 M25-669	70-88 kW (95-120 PS)	CX 25 TD CX 2500 TD C25 DT C25 TD	04/83-02/94	<p>02-24960-02</p>  <p>02-27015-01 0197.R9 +95 636 687</p> 	<p>61-27015-10 0209.L6 95,5 Ø 1,7 mm</p> 	<p>14-32080-01 0204.41 (8x) +0204.42 (8x)</p> 	<p>71-25612-20 0249.78</p> 	<p>12-23062-01 5 403 212 (8x)</p>  <p>70-23062-00 5 403 212</p> 	<p>50-92221-20  4x 0348.H0</p>  <p>71-25639-10  4x 0349.F0</p>  <p>8x</p>	<p>81-33859-00  0514.32 75x90 A SL RD FPM/ACM</p> 		
2,5	M25-666	122 kW (168 PS)				<p>61-25730-00 96 18 348 180 94,5 Ø 1,3 mm</p> 							

CITROEN

<p>Ltr.  2,5 THX (DJ5TED) 79 kW (107 PS) JUMPER Bus TDI JUMPER TDI</p> <p>12/96-04/02 </p>	<p></p> <p>01-34110-01 0197.W4 +0209.T5</p> 	<p></p> <p>02-34110-01 0197.W3 +0209.T5</p> 	<p></p>	<p></p> <p>04-10204-01 </p> 	<p></p> <p>61-34110-00 0209.T5 93 Ø 1,35 mm MLS</p> 	<p></p> <p>14-32156-01 0204.87 (14x) +0204.88 (8x)</p> 	<p></p> <p>71-33723-00 0249.79</p> 	<p></p> <p>12-26058-02 0956.19 (8x)</p>  <p>70-26058-00 0956.19</p> 	<p></p> <p>71-37096-00  2x 0348.K4</p>  <p>71-37097-00  0349.G4</p>	<p></p> <p>70-31414-10</p> 	<p></p> <p>81-34457-00  0326.25 64x88 A SL RD FPM/ACM</p>  <p>81-34458-00  0119.14 98x120 A SL LD FPM/ACM</p>  <p>81-25451-10 N 0514.15 35x50 A SL RD FPM</p>  <p>81-17110-20 N 0807.26 32x52 A SL LD FPM/ACM</p> 
<p>2,5 THX (DJ5TED) 79 kW (107 PS) JUMPER TDI</p> <p>03/00-11/00</p>	<p></p> <p>01-34110-01 0197.W4 +0209.T5</p> 	<p></p> <p>02-34110-01 0197.W3 +0209.T5</p> 			<p></p> <p>61-34110-00 0209.T5 93 Ø 1,35 mm MLS</p> 	<p></p> <p>14-32156-01 0204.87 (14x) +0204.88 (8x)</p> 	<p></p> <p>71-33723-00 0249.79</p> 	<p></p> <p>12-26058-02 0956.19 (8x)</p>  <p>70-26058-00 0956.19</p> 	<p></p> <p>71-37096-00  2x 0348.K4</p>  <p>71-37097-00  0349.G4</p>	<p></p> <p>70-31414-10</p> 	<p></p> <p>81-34457-00  0326.25 64x88 A SL RD FPM/ACM</p>  <p>81-34458-00  0119.14 98x120 A SL LD FPM/ACM</p>  <p>81-25451-10 N 0514.15 35x50 A SL RD FPM</p>  <p>81-17110-20 N 0807.26 32x52 A SL LD FPM/ACM</p> 

CITROEN

Ltr.  2,5 THY (DK5ATE) THZ (DJ5T) T9A (DJ5) 63-95 kW (86-129 PS) JUMPER JUMPER Bus D JUMPER D XM TD 03/94-04/02 



01-29160-01
0197.17
+0209.R3



02-29160-01
0197.76
+0209.R3

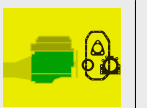

61-29160-00
0209.R3
93 Ø
1,6 mm

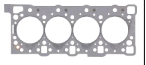

14-32164-01
0204.74 (14x)
+0204.75 (8x)

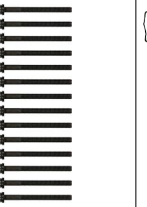

71-33723-00
0249.79



12-26058-01
0659.19 (12x)

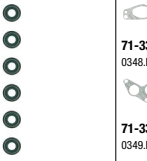

70-26058-00
0956.19

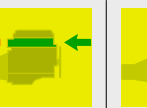
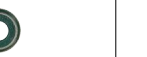

71-33687-00  
0348.K1



71-33786-00  
0348.F9



71-33688-00 
0349.E7

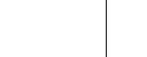

70-31414-10

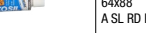

81-34457-00 
0326.25
64x88
A SL RD FPM/ACM





81-34458-00 
0119.14
98x120
A SL LD FPM/ACM





81-25451-10 
0514.15
35x50
A SL RD FPM



81-34142-00  
0807.21
47,5x62
A SL LD FPM/ACM



81-34143-00  
0807.15
40x62
A SL LD FPM/ACM



CITROEN

Ltr. 2,5 T8A (DJ5T) 76 kW (103 PS) JUMPER Bus TD JUMPER TD 03/94-04/02 1

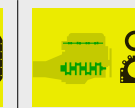
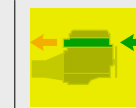

01-29160-01
0197.17
+0209.R3

02-29160-01
0197.76
+0209.R3

04-10204-01

61-29160-00
0209.R3
93 Ø
1,6 mm

14-32164-01
0204.74 (14x)
+0204.75 (8x)

71-33723-00
0249.79

12-26058-01
0659.19 (12x)

71-33687-00

0348.K1

71-33786-00

0348.F9

71-33688-00

0349.E7

70-26058-00
0956.19

70-31414-10

81-34457-00

0326.25
64x88
A SL RD FPM/ACM

81-34458-00

0119.14
98x120
A SL LD FPM/ACM

81-25451-10

0514.15
35x50
A SL RD FPM

81-34142-00

0807.21
47,5x62
A SL LD FPM/ACM

81-34143-00

0807.15
40x62
A SL LD FPM/ACM

2.7 DT17ED4 150 kW (204 PS) C5 HDI C6 HDI 205 FAP 09/05

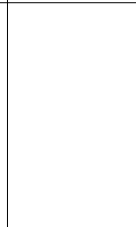
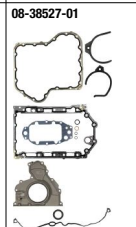
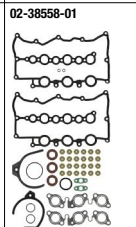

61-34875-10 2x
0209.DW
82,5 Ø
1,17 mm
MLS

14-32344-01 2x
0204.A8 (8x)

71-38558-00 2x
0249.E1

12-38546-01 24x
0956.S3 (24x)

71-34888-00 2x
0349.L0

71-38527-00
0164.75

71-41252-00
0304.57

81-34316-00

0326.29
35x50
A SL RD PTFE ACM

81-90050-00

0514.C0

81-38536-00























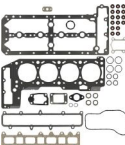

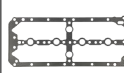

0807.36
26x45
A SL WD FPM

CITROEN														
Ltr.														
2,8	F28TDCR	94 kW (128 PS)												
2,8	8140.43C	77 kW (105 PS)	JUMPER Bus HDI	06/03-06/06										
2,8	8140.43N	107 kW (146 PS)	JUMPER HDI	04/04-06/06										











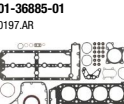
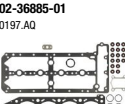



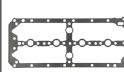

CITROEN														
Ltr.														
2,8 8140.43S	89-94 kW (122-128 PS)	JUMPER Bus HDI JUMPER HDI	09/00-10/10	01-33951-10 0197.Y2 	02-33951-10 		04-10047-01 0197.Y2 	61-33950-00 0209.DC 1,3 mm 61-33950-10 0209.OE 1,4 mm 61-33950-20 0209.OF 1,5 mm 		71-33951-10 0249.A0 71-33956-00 0249.C3 	12-34914-05 0956.44 (8x) 70-34914-00 0956.44 	71-33621-00 0348.N5 4x 71-33654-00 0349.H5 4x 70-34914-00 0956.44 8x 	71-33944-10 71-83048-00 0304.54 	
2,8 8140.63 (F28D)	64 kW (87 PS)	JUMPER Bus D	01/99-02/02	01-33956-06 0197.Z4 	02-33956-04 0197.Z0 			61-33950-00 0209.DC 1,3 mm 61-33950-10 0209.OE 1,4 mm 61-33950-20 0209.OF 1,5 mm 		71-33956-00 0249.C3 	12-34914-05 0956.44 (8x) 70-34914-00 0956.44 	71-33621-00 0348.N5 4x 71-33654-00 0349.H5 4x 70-34914-00 0956.44 8x 	71-33944-10 71-83048-00 0304.54 	81-10173-00 0514.C1 FPM 81-90042-00 0514.A8 FPM 81-33627-00 55x70 A SL RD FPM
3,0 DT20C	155-177 kW (211-241 PS)	C5 HDI 240 C6 C6 HDI	04/09-10/14					61-36610-00 0209.GX 85 Ø 1,17 mm MLS 2x 61-36610-10 0209.GY 85 Ø 1,22 mm MLS 3x 61-36610-20 0209.GZ 85 Ø 1,27 mm MLS 4x 61-36610-30 0209.HA 85 Ø 1,32 mm MLS 5x 	14-32344-01 0204.A8 (8X) 2x 	71-38558-00 0249.E1 2x 	12-38546-01 0956.53 (24x) 24x 70-38546-00 0956.53 	71-34888-00 0349.L0 2x 	71-38527-00 0164.75 71-41252-00 0304.57 	81-34316-00 0326.29 35x50 A SL RD PTFE ACM 81-90050-00 0514.C0 81-38536-00 0807.36 26x45 A SL WD FPM

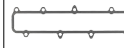
CITROEN











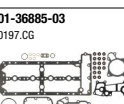
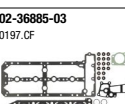

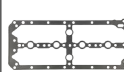

Ltr.  3,0 F1CE0481D (F30DT) 115 kW (156-157 PS) JUMPER HDI 155  07/10

										
01-36885-01 0197.AR 	02-36885-01 0197.AQ 			61-36885-00 0209.FJ 1,1 mm MLS 61-36885-10 ✖ 1,2 mm MLS 61-36885-20 ✖ 16 068 487 80 1,3 mm MLS 	14-32359-01 0204.C6 (6x) +0204.C7 (4x) +0204.C8 (4x) +0204.C9 (1x) 	71-38371-00 0249.F7 	12-37553-01 0951.61 (16x)  70-37553-00 0951.61 16x 	71-38349-00  0348.T7  71-38362-00  0349.L8 	71-38202-00 0304.59 	81-38091-00  0514.C9 50x70 PTFE  81-38089-00  0514.E4 90x120 FPM 















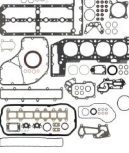

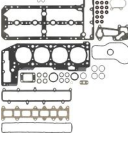



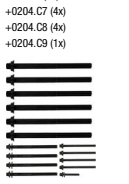













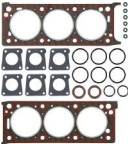

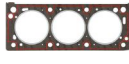

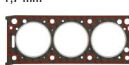

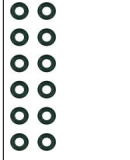











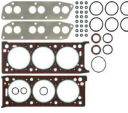

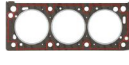

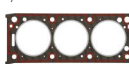

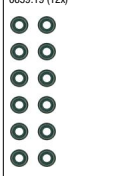

3,0 F1CE0481D (F30DT) 116 kW (157 PS) JUMPER HDI 160 09/06

			04-10319-01 	61-36885-00 0209.FJ 1,1 mm MLS 61-36885-10 ✖ 1,2 mm MLS 61-36885-20 ✖ 16 068 487 80 1,3 mm MLS 	14-32359-01 0204.C6 (6x) +0204.C7 (4x) +0204.C8 (4x) +0204.C9 (1x) 	71-38371-00 0249.F7 	12-37553-01 0951.61 (16x)  70-37553-00 0951.61 16x 	71-38349-00  0348.T7  71-38362-00  0349.L8 	71-38202-00 0304.59 	81-38091-00  0514.C9 50x70 PTFE  81-38089-00  0514.E4 90x120 FPM 
---	---	--	--	--	--	--	---	--	--	--

3,0 F1CE3481E (F30DTE) 130 kW (177 PS) JUMPER HDI 180 07/11

				61-36885-00 0209.FJ 1,1 mm MLS 61-36885-10 1,2 mm MLS 61-36885-20 16 068 487 80 1,3 mm MLS 	14-32359-01 0204.C6 (6x) +0204.C7 (4x) +0204.C8 (4x) +0204.C9 (1x) 	71-38371-00 0249.F7 	12-37553-01 0951.61 (16x)  70-37553-00 0951.61 16x 	71-38349-00  0348.T7  71-38362-00  0349.L8 	71-38202-00 0304.59 	81-38091-00  0514.C9 50x70 PTFE  81-38089-00  0514.E4 90x120 FPM 
--	--	--	--	--	--	--	---	--	--	--

CITROEN

<p>Ltr.   </p> <p>3,0 F30DTE (F1CE3481N) 107 kW (146 PS) JUMPER HDI 145 07/10</p>	 01-36885-06 	 02-36885-05 	 01-36885-10 1,2 mm MLS	 01-36885-20 ✕ 16 068 487 80 1,3 mm MLS 	61-36885-00 ✕ 0209.FJ 1,1 mm MLS 61-36885-10 1,2 mm MLS 61-36885-20 ✕ 16 068 487 80 1,3 mm MLS 	14-32359-01 0204.C6 (6x) +0204.C7 (4x) +0204.C8 (4x) +0204.C9 (1x) 	71-38371-00 0248.F7 	12-37553-01 0951.61 (16x)  70-37553-00 0951.61 	71-38349-00   0348.T7  71-38362-00  0349.L8 	71-38202-00 0304.59 	81-38091-00  0514.C9 50x70 PTFE  81-38089-00  0514.E4 90x120 FPM 
<p>3,0 SFZ (ZPJ/Z) 123 kW (167 PS) XM XM V6 05/89-12/97</p>		02-33615-02 0197.E1 +0209.A4 +0209.A5 +0956.30 (12x) 	08-33679-01 	61-33615-00  0209.A4 95,2 Ø 1,7 mm  61-33620-00  0209.A5 95,2 Ø 1,7 mm 	14-32084-01 0204.53 (16x) 			12-25837-03 0956.22 (12x)  70-25837-00 0956.22 	40-76752-00  0348.43  71-28604-00  96 130 969 		81-25926-10  0326.12 42x62 A RD FPM  81-18304-00  0514.50 80x100 A LD MVQ  81-22660-00  0236.24 32x45 A LD FPM 
<p>3,0 SKZ (ZPJ/Z) UKZ (ZPJ/Z) 147 kW (200 PS) XM V6 XM V6 24V 01/90-10/00</p>		02-33615-03 0197.E1 +0209.A4 +0209.A5 +0956.30 (24x) 	08-33679-01 	61-33615-00  0209.A4 95,2 Ø 1,7 mm  61-33620-00  0209.A5 95,2 Ø 1,7 mm 	14-32084-01 0204.53 (16x) 		70-31414-10 	12-26058-01 0659.19 (12x)  70-26058-00 0956.19 	71-33681-00   0349.74 	70-31414-10 	81-25926-10  0326.12 42x62 A RD FPM  81-18304-00  0514.50 80x100 A LD MVQ  81-22660-00  0236.24 32x45 A LD FPM 

CITROEN																
3,0	UFZ (ZPJZ)	123-125 kW (167-170 PS)	XM XM V6		05/89-10/00		02-33615-02 0197.E1 +0209.A4 +0209.A5 +0956.30 (12x)	08-33679-01 		61-33615-00 R 0209.A4 95,2 Ø 1,7 mm 61-33620-00 L 0209.A5 95,2 Ø 1,7 mm 	14-32084-01 0204.53 (16x) 	70-31414-10 	12-25837-03 0956.22 (12x) 70-25837-00 0956.22 12x 	40-76752-00 6x 0348.43 71-28604-00 6x 96 130 969 	70-31414-10 	81-25826-10 K ↔ 0326.12 42x62 A RD FPM 81-18304-00 K ↔ 0514.50 80x100 A LD MVQ 81-22660-00 N 2x 0236.24 32x45 A LD FPM
3,0	XFU (ES9A) XFV (ES9A)	152-155 kW (207-211 PS)	C5 C5 V6 C6 V6	09/04			61-36510-00 L 0209.OX 89 Ø 0,74 mm MLS 61-36510-10 L 0209.OZ 89 Ø 0,95 mm MLS 61-36510-00 R 0209.OY 89 Ø 0,74 mm MLS 61-36510-10 R 0209.1A 89 Ø 0,95 mm MLS 			70-31414-10 	12-31306-05 0956.38 (24x) 70-31306-00 0956.64 24x 	71-38551-00 K ↔ 0348.G0 71-38556-00 K ↔ 2x 0348.P9 71-38541-00 K ↔ 2x 0349.G0 	70-31414-10 	81-38529-00 K ↔ 0514.A9 42x56 A SL RD PTFE (Polytetrafluorethylen)/ACM (Polyacryl-Kautschuk) 81-38528-00 K ↔ 0119.18 98x120 A SL LD PTFE (Polytetrafluorethylen)/ACM (Polyacryl-Kautschuk) 81-38531-00 N 4x 0807.34 38x50 A SL RD PTFE (Polytetrafluorethylen)/ACM (Polyacryl-Kautschuk) 		



























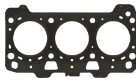

CITROEN

Ltr. 3,0 XFX (E59J4S) 150-173 kW (204-235 PS) C5 C5 Carlsson C5 V6 C6 V6 C8 C8 V6 03/01

	<p>02-36510-01 V</p> <p>02-36515-01 H</p> <p>02-38556-01 2x</p>	<p>08-34458-01 10086</p> <p>08-38528-01 10087→</p>		<p>61-36510-00 L</p> <p>0209.0X 89 Ø 0,74 mm MLS</p> <p>61-36510-10 L</p> <p>0209.0Z 89 Ø 0,95 mm MLS</p> <p>61-36515-00 R</p> <p>0209.0Y 89 Ø 0,74 mm MLS</p> <p>61-36515-10 R</p> <p>0209.1A 89 Ø 0,95 mm MLS</p>		<p>70-31414-10</p>	<p>12-31306-05</p> <p>0956.38 (24x)</p> <p>70-31306-00</p> <p>0956.64</p>	<p>71-38551-00 L </p> <p>0348.00</p> <p>71-38556-00 L 2x</p> <p>0348.P9</p> <p>71-38541-00 2x</p> <p>0349.G0</p>	<p>70-31414-10</p>	<p>81-51109-30 K </p> <p>0514.82 42x56 A SL RD FPM 10086</p> <p>81-38529-00 K </p> <p>0514.A9 42x56 A SL RD PTFE (Polytetrafluorethylen)/ACM (Polyacryl-Kautschuk) 10087→</p> <p>81-34458-00 K </p> <p>0119.14 98x120 A SL LD FPM/ACM 10086</p> <p>81-38528-00 K </p> <p>0119.18 98x120 A SL LD PTFE (Polytetrafluorethylen)/ACM (Polyacryl-Kautschuk) 10087→</p> <p>81-34146-00 N 4x</p> <p>0807.24 38x50 A SL RD FPM</p>	

CITROEN

Ltr.  3,0 XEZ (ES9J4) 140-142 kW (190-194 PS) XANTIA V6 XANTIA 24V XM V6  01/97-04/03

										
	<p>02-36530-01 R  0008570→</p>  <p>02-36525-01 L  008570→</p> 	<p>08-34458-01</p> 		<p>61-36525-00 L 0209.ON 89 Ø 1,45 mm MLS  0008570→</p>  <p>61-36530-00 R 0209.OP 89 Ø 1,45 mm MLS  0008570→</p> 		<p>70-31414-10</p> 	<p>12-31306-05 0956.38 (24x)</p>  <p>70-31306-00 0956.64</p> 	<p>71-38596-00 L 2x 0348.L5</p>  <p>71-38594-00 L 2x 0348.K7</p>  <p>71-38541-00 2x 0349.G0</p> 	<p>70-31414-10</p> 	<p>81-51109-30 K 4x 0514.82 42x56 A SL RD FPM</p>  <p>81-34458-00 K 4x 0119.14 98x120 A SL LD FPM/ACM</p>  <p>81-34146-00 N 4x 0807.24 38x50 A SL RD FPM</p> 

Haftungsausschluss

(für Katalog)

Alle Angaben in unserem Katalog wurden von uns sorgfältig geprüft, sind jedoch unverbindlich. Ersatzansprüche wegen Katalogangaben werden von uns nicht anerkannt. Der Käufer ist selbst verpflichtet, zu prüfen, ob unsere Teile für seine Zwecke geeignet sind. In allen Zweifelsfällen sollte Rücksprache mit unserem technischen Kundendienst erfolgen **Tel. +49 731 7046 999**.

Technische Weiterentwicklungen oder Änderungen bleiben vorbehalten, soweit damit keine Nachteile für den Kunden verbunden sind.

Angaben, Namens- und Markenzeichen, Beschreibungen, Nummern von Fahrzeugnummern und Herstellerzeichen, Original-Ersatzteilnummern der Fahrzeug- und Motorenhersteller u. a. sind ausschließlich für interne Zwecke gedacht. Solche Kennzeichnungen dürfen Fahrzeugbesitzern gegenüber nicht verwendet werden.

Wir weisen ausdrücklich darauf hin, dass alle von uns gelieferten Teile von geschultem Fachpersonal einzubauen sind. Reinz haftet für Fehler in diesem Katalog nur, wenn diese für den Kunden nicht offenbar erkennbar sind sowie nur bei Vorsatz und grober Fahrlässigkeit von Reinz, eines Vertreters oder eines Erfüllungsgehilfen. Dieser Haftungsausschluss gilt nicht im Rahmen

des Anwendungsbereichs des Produkthaftungsgesetzes und nicht bei Verletzung von Körper, Leben und Gesundheit, sowie bei der Verletzung von sog. Kardinalpflichten. Darüber hinaus ist unsere Haftung für Schäden, insbesondere für Personen-, Sach- oder Vermögensschäden, die unmittelbar oder mittelbar im Zusammenhang mit der Nutzung dieses Kataloges auftreten, sowie für nicht voraussehbare Schäden ausgeschlossen.

Reinz ist Inhaber aller Schutzrechte an den in diesem Katalog gespeicherten Daten. Kopie, Nachdruck, ganze oder teilweise Übernahme der Inhalte und Vervielfältigung, auch auszugsweise, ist nur mit unserer vorheriger schriftlicher Zustimmung sowie mit unserem Urheberrechtsvermerk zulässig.

Für Bestellungen, welche ab dem Erscheinungsdatum eines neuen Katalogs getätigt werden, sind alleine die Angaben des neuen Katalogs maßgeblich. Auf Angaben im Vorkatalog kann bei Neubestellungen nicht mehr zurückgegriffen werden.

Sofern Sie noch Fragen haben, bitten wir Sie, sich mit uns in Verbindung zu setzen.

VictorReinz.com/AGB

Exclusion of Liability

(for catalog)

All details in our catalog have been thoroughly checked by us but are however not binding. Right to damages on account of catalog details will not be recognized. The purchaser is obliged to check if our parts are suitable for their use. In all doubtful cases, the purchaser should consult our technical customer service under **+49 731 7046 999**.

We reserve the right to further technical developments or changes as long as no disadvantage for the customer results.

Details, name and trademarks, descriptions, numbers from vehicle numbers and manufacturer symbols, original vehicle replacement part numbers and engine manufacturer etc. are solely for internal use. Such labels must not be used with vehicle owners.

We specifically point out that all parts supplied by us must be assembled by trained specialists.

Reinz is liable for mistakes in this catalog only when they are not clearly recognizable for the customer, as well as by intent or gross negligence on the part of Reinz, its representative or vicarious agent. This exclusion of liability does not apply within the framework of the field of

application of the product liability laws and not by bodily harm, life and health, as well as by violation of cardinal duties. In addition, our liability for damages, especially personal, property or financial damages that occur directly or indirectly as a result of the use of this catalog, as well as non-foreseeable damages are excluded.

Reinz is the owner of all patent rights on the data stored in this catalog. Copies, reprints, whole or partial takeover of the contents and duplication even in excerpts are only permissible with our prior written approval, as well as with our copyright note.

For orders placed after the publication date of a new catalog, only the details in the new catalog are binding and no fall back to details in the previous catalog is possible.

In case you have further questions, do not hesitate to contact us.

VictorReinz.com/AGB

VictorReinz.com

reinz.info@dana.com

Technical Hotline +49 (0)731 7046-9 99

REINZ-Dichtungs-GmbH

Reinzstrasse 3-7
89233 Neu-Ulm
Germany
+49 (0)731 7046-0

VICTOR REINZ[®]

