

**VICTOR REINZ®**

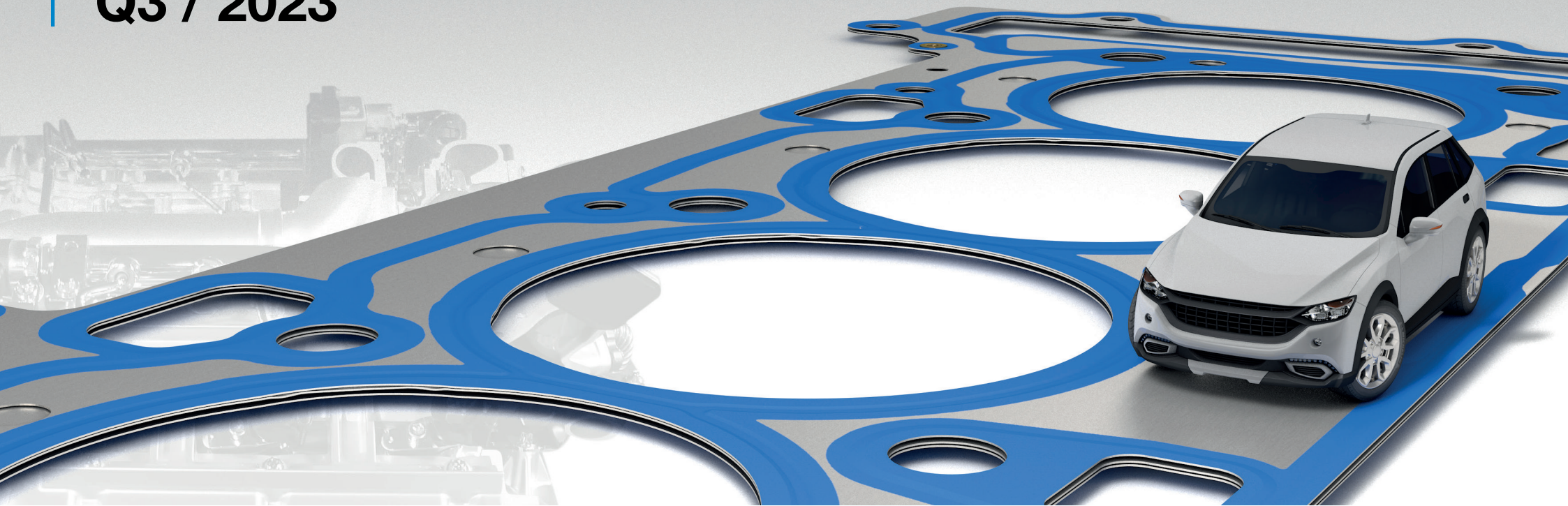

**DACIA**  
**Q3 / 2023**



**[VictorReinz.com/online-catalog](https://VictorReinz.com/online-catalog)**

# Victor Reinz®

## at a Glance



### Online Catalog

[VictorReinz.com/online-catalog](https://VictorReinz.com/online-catalog)



### Newsletter

[VictorReinz.com/EN/News/Newsletter.aspx?region](https://VictorReinz.com/EN/News/Newsletter.aspx?region)



### Youtube

[www.youtube.com/user/VictorReinzSealingEN](https://www.youtube.com/user/VictorReinzSealingEN)



### Catalog News

[VictorReinz.com/news](https://VictorReinz.com/news)



### Technical Service Information

[VictorReinz.com/tsi](https://VictorReinz.com/tsi)



### Facebook

[www.facebook.com/VictorReinzParts](https://www.facebook.com/VictorReinzParts)



### Just seal it!

[VictorReinz.com/jsi](https://VictorReinz.com/jsi)



### Technical Datasheet

[VictorReinz.com/jsi-datasheet](https://VictorReinz.com/jsi-datasheet)



### LinkedIn

[www.linkedin.com/showcase/victor-reinz-emea](https://www.linkedin.com/showcase/victor-reinz-emea)



### Safety Datasheet

[VictorReinz.com/jsi-datasheet](https://VictorReinz.com/jsi-datasheet)



### Homepage

[VictorReinz.com](https://VictorReinz.com)

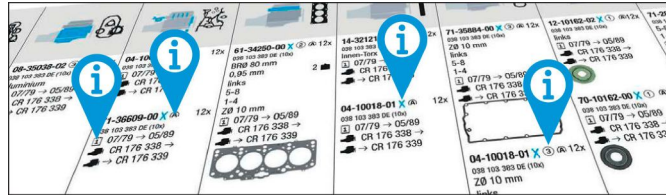

[VictorReinz.com/catalog-info](https://VictorReinz.com/catalog-info)

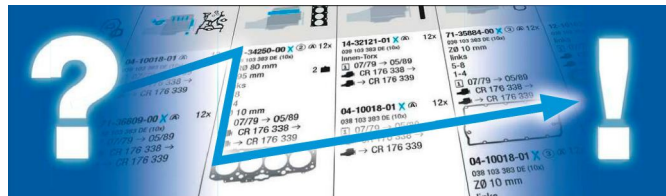

[VictorReinz.com/catalog-how-to-use](https://VictorReinz.com/catalog-how-to-use)

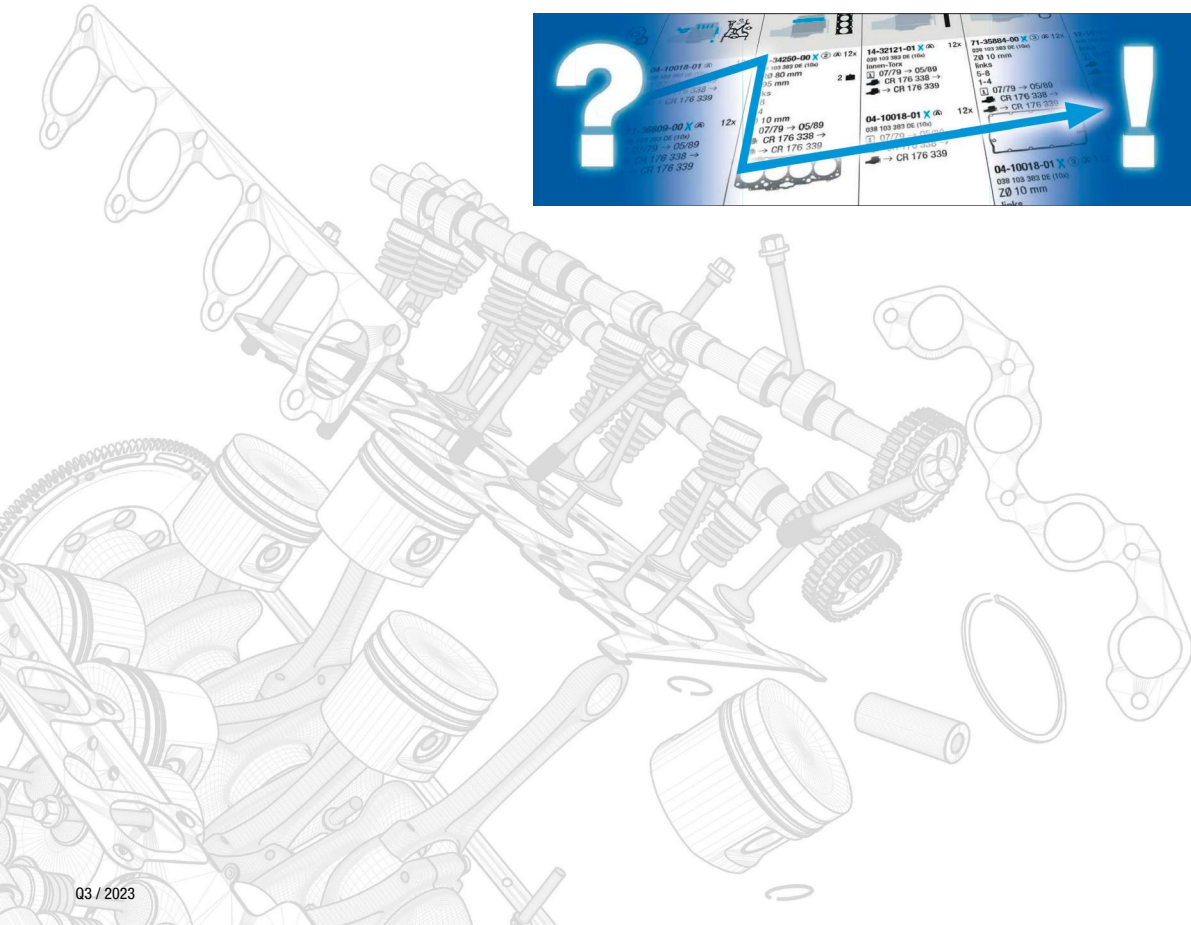

# DACIA



**0-9**  
810-02/-99 ..... 9

**B**  
B4D 400 ..... 6  
B4D 401 ..... 6

**C**  
C2J ..... 10

**D**  
D4F 732 ..... 7  
D4F 734 ..... 7

**F**  
F8Q 600 ..... 22  
F8Q 630 ..... 22  
F8Q 636 ..... 22

**H**  
H4B 400 ..... 5  
H4B 408 ..... 5  
H4B 410 ..... 6  
H4D 450 ..... 7  
H4D 460 ..... 7  
H4D 470 ..... 7  
H4D 480 ..... 7  
H4M 430 ..... 17  
H4M 438 ..... 17  
H4M 730 ..... 17  
H4M 738 ..... 17  
H4M 740 ..... 17  
H5F 402 ..... 8  
H5F 404 ..... 8  
H5F 408 ..... 8  
H5F 410 ..... 8-9  
H5H 470 ..... 9  
H5H 480 ..... 9

**K**  
K4M 606 ..... 18  
K4M 616 ..... 18  
K4M 642 ..... 18  
K4M 690 ..... 19  
K4M 694 ..... 19



K4M 696 ..... 19  
K4M 842 ..... 19  
K7J 710 ..... 10  
K7J 714 ..... 10  
K7M 690 ..... 20  
K7M 710 ..... 20  
K7M 718 ..... 20  
K7M 732 ..... 20  
K7M 800 ..... 21  
K7M 812 ..... 21  
K9K 612 ..... 11  
K9K 626 ..... 11  
K9K 656 ..... 12  
K9K 658 ..... 12  
K9K 666 ..... 12  
K9K 667 ..... 12  
K9K 790 ..... 13  
K9K 792 ..... 14  
K9K 796 ..... 14-15  
K9K 830 ..... 15  
K9K 838 ..... 15  
K9K 846 ..... 16  
K9K 856 ..... 16  
K9K 858 ..... 16  
K9K 872 ..... 17  
K9K 874 ..... 17  
K9K 884 ..... 16  
K9K 892 ..... 16  
K9K 894 ..... 16  
K9K 896 ..... 16  
K9K 898 ..... 16

DACIA

Ltr. H4B 400 H4B 408 66 kW (90 PS) LOGAN II LOGAN MCV II SANDERO II 10/12

	02-10185-03	08-10045-01 140710	04-10331-01	61-10185-00 73,5 Ø 0,6 mm MLS	14-12221-01	71-12218-00	12-53036-02	71-12217-00  3x	70-31414-10	81-10478-00 40x52 PTFE 140710			81-53592-00 13 51 01K TDA 40x52 SL RD FPM 140710	81-10479-00 84x117 PTFE 140710→
		08-10042-01 140710→											81-54111-00 12 27 91H GDA 84,2x117,22 A SL LD FPM 140710→	

DACIA														
0,9	H4B 410	66 kW (90 PS)	LOGAN II LOGAN MCV II	09/15										
Ltr.					02-10185-03	08-10042-01 140710→	04-10331-01	61-10185-00 73,5 Ø 0,6 mm MLS	14-12221-01	71-12218-00	12-53036-02	71-12217-00 3x 71-40013-00	70-31414-10	81-53592-00 K↔ 13 51 01K 10A 40x52 SL RD FPM 140710→ 81-10478-00 K↔ 40x52 PTFE 140710→ 81-54111-00 K↔ 12 27 91H 00A 84,2x117,22 A SL LD FPM 140710→ 81-10479-00 K↔ 84x117 PTFE 140710→
1,0	B4D 400	54 kW (73 PS)	LOGAN II LOGAN MCV II SANDERO II	12/16				61-10126-00 11 04 429 70R 72,2 Ø MLS	14-18916-01	70-31414-10	12-18919-01	71-18918-00 3x 82 01 695 837 71-18922-00 20 81 348 76R	70-31414-10	81-10629-00 K↔ 13 51 003 69R 40x52 A SL RD FPM 81-10628-00 K↔ 12 27 929 67R 69x89 A SL LD FPM
1,0	B4D 401	54 kW (73 PS)	LOGAN II LOGAN MCV II SANDERO II	12/16				61-10126-00 11 04 429 70R 72,2 Ø MLS	14-18916-01	70-31414-10	12-18919-01	71-18918-00 3x 82 01 695 837 03/20→ 71-18922-00 20 81 348 76R	70-31414-10	81-10629-00 K↔ 13 51 003 69R 40x52 A SL RD FPM 81-10628-00 K↔ 12 27 929 67R 69x89 A SL LD FPM

DACIA															
Ltr.															
1,0	H4D 450 H4D 460 H4D 470 H4D 480	67-74 kW (91-101 PS)	DUSTER JOGGER LOGAN SANDERO	01/19 <b>[NEW]</b>											
					02-11359-01	08-11359-01		61-11226-00 73,1 Ø 0,65 mm MLS	14-12221-01		12-21170-01 70-21170-00 12x	71-12217-00  3x 71-21023-00		81-10478-00 40x52 PTFE	 81-10479-00 84x117 PTFE
1,2	D4F 732	54-55 kW (73-75 PS)	LOGAN LOGAN II LOGAN MCV II SANDERO SANDERO II	02/06				61-33740-00 70 Ø MLS	14-32232-01		12-38628-01 70-38628-00 16x	11-35242-01 71-38626-00	70-31414-10	81-34461-00 32x44 A SL RD PTFE ACM	 81-34462-00 70x86 A SL LD PTFE ACM
					02-33740-03	08-34461-01		61-33740-00 70 Ø MLS	14-32232-01	71-37912-00	12-38628-01 70-38628-00 16x	11-35242-01 71-38626-00	71-33366-00	81-34461-00 32x44 A SL RD PTFE ACM	 81-34462-00 70x86 A SL LD PTFE ACM
1,2	D4F 734	53-55 kW (72-75 PS)	LOGAN LOGAN LPG LOGAN MCV II SANDERO II	02/06				61-33740-00 70 Ø MLS	14-32232-01		12-38628-01 70-38628-00 16x	11-35242-01 71-38626-00	71-33366-00	81-34461-00 32x44 A SL RD PTFE ACM	 81-34462-00 70x86 A SL LD PTFE ACM
					02-33740-03	08-34461-01		61-33740-00 70 Ø MLS	14-32232-01		12-38628-01 70-38628-00 16x	11-35242-01 71-38626-00	71-33366-00	81-34461-00 32x44 A SL RD PTFE ACM	 81-34462-00 70x86 A SL LD PTFE ACM

DACIA

Ltr.	Motor	Power	Model	Year	Image 1	Image 2	Image 3	Image 4	Image 5	Image 6	Image 7	Image 8	Image 9	Image 10	Image 11	Image 12		
1,2	H5F 402 H5F 404	84-92 kW (114-125 PS)	DOKKER DUSTER LODGY	03/12														
					02-10256-01	08-10045-01 → 140710	04-10337-01	61-10256-00 73,7 Ø 0,6 mm MLS	14-32378-01	71-10887-00	12-53036-01	71-10894-00 4x 71-40014-00	70-31414-10	81-53592-00 K 13 51 01K TOA 40x52 SL RD FPM → 140710				
						08-10042-01 → 140710					70-53036-10 16x			81-10478-00 K 40x52 PTFE → 140710				
														81-54111-00 K 12 27 91H COA 84,2x117,22 A SL LD FPM → 140710				
														81-10479-00 K 84x117 PTFE → 140710				
1,2	H5F 408	85-92 kW (116-125 PS)	DOKKER DUSTER	10/13														
					02-10256-01	08-10042-01	04-10337-01	61-10256-00 73,7 Ø 0,6 mm MLS	14-32378-01	71-10887-00	12-53036-01	71-10894-00 4x 71-40014-00	70-31414-10	81-10478-00 K 40x52 PTFE				
											70-53036-10 16x			81-10479-00 K 84x117 PTFE				
1,2	H5F 410	92 kW (125 PS)	DUSTER	06/15-01/18														
					02-10256-01	08-10042-01 → 140710		61-10256-00 73,7 Ø 0,6 mm MLS	14-32378-01	71-10887-00	12-53036-01	71-10894-00 4x 71-40014-00	70-31414-10	81-10478-00 K 40x52 PTFE				
											70-53036-10 16x			81-10479-00 K 84x117 PTFE				



DACIA															
1,2	H5F 410	92 kW (125 PS)	DUSTER	10/17		02-10256-01 	08-10042-01 140710 → 	04-10337-01 	61-10256-00 73.7 Ø 0,6 mm MLS 	14-32378-01 	71-10887-00 	12-53036-01  70-53036-10 16x	71-10894-00  4x  71-40014-00 	70-31414-10 	81-10478-00 40x52 PTFE  81-10479-00 84x117 PTFE 
1,3	H5H 470 H5H 480	75-110 kW (102-150 PS)	DOKKER DUSTER LODGY	01/19 <b>[NEW]</b>	02-11086-02	08-10186-01  		61-11086-00 73 Ø 0,6 mm MLS 	14-19487-01 		12-20417-01 70-20417-00 8x 70-20419-00 8x	71-19650-00  71-19652-00  4x 71-19677-00 	70-31414-10 	81-10478-00 40x52 PTFE  81-10479-00 84x117 PTFE 	
1,3	810-02/-99	40 kW (54 PS)	1300 1304 1310	12/72-07/04	02-21995-04 77 01 452 151 			61-21995-40 77 00 576 242 74 Ø 1,5 mm 		71-19799-10 77 00 723 967 		71-22789-20 77 00 854 652  71-22426-10 77 00 502 706 	10-12965-01 77 01 457 561 	81-21798-40 35x50 A SL RD FPM/ACM  81-51147-30 35x50 A SL RD MVQ  81-18304-00 80x100 A LD MVQ 	



DACIA													
Ltr.													
1,4 C2J	NOVA	04/96-03/01	48 kW (65 PS)	<p><b>02-19799-01</b></p> <p><b>02-25295-12</b></p>	<p><b>08-12809-01</b></p>		<p><b>61-25295-20</b> 77 Ø 1,2 mm</p>	<p><b>14-32162-01</b></p>	<p><b>71-19799-10</b> 77 00 723 967</p>	<p><b>12-26058-02</b> 77 00 103 872 (8x)</p> <p><b>70-26058-00</b> 77 00 103 872</p> <p>8x</p>	<p><b>71-25357-10</b> </p>	<p><b>70-31414-10</b></p>	<p><b>81-51147-30</b> </p> <p>35x50 A SL RD MVO</p> <p><b>81-18304-50</b> </p> <p>77 00 859 692 80x100 A SL LD FPM</p>
1,4 K7J 710	LOGAN LOGAN MCV SANDERO	09/04	55 kW (75 PS)	<p><b>02-34830-01</b> 60 01 548 043 +77 01 471 932</p>	<p><b>08-34359-01</b></p>		<p><b>61-34830-00</b> 82 00 296 969 80,3 Ø 0,3 mm MLS</p>	<p><b>14-32089-01</b> 77 00 738 986 (5x) +77 00 738 987 (5x)</p>	<p><b>71-31622-10</b> 77 01 471 719</p> <p><b>71-31622-20</b> 77 00 739 165</p>	<p><b>12-26058-02</b> 77 00 103 872 (8x)</p> <p><b>70-26058-00</b> 77 00 103 872</p> <p>8x</p>	<p><b>11-37141-01</b> </p> <p>77 01 471 932</p> <p><b>71-33609-00</b> </p> <p>77 00 867 360</p>	<p><b>71-34359-00</b> 77 00 273 486</p>	<p><b>81-15855-40</b> </p> <p>77 00 273 776 35x47 A RD FPM</p> <p><b>81-18304-50</b> </p> <p>77 00 859 692 80x100 A SL LD FPM</p> <p><b>81-17539-50 N</b></p> <p>77 00 749 395 30x42 A SL RD FPM</p>
1,4 K7J 714	LOGAN SANDERO MPI LPG	02/06	53-55 kW (72-75 PS)	<p><b>02-34830-01</b> 60 01 548 043 +77 01 471 932</p>	<p><b>08-34359-01</b></p>		<p><b>61-34830-00</b> 82 00 296 969 80,3 Ø 0,3 mm MLS</p>	<p><b>14-32089-01</b> 77 00 738 986 (5x) +77 00 738 987 (5x)</p>	<p><b>71-31622-10</b> 77 01 471 719</p>	<p><b>12-26058-02</b> 77 00 103 872 (8x)</p> <p><b>70-26058-00</b> 77 00 103 872</p> <p>8x</p>	<p><b>11-37141-01</b> </p> <p>77 01 471 932</p> <p><b>71-33609-00</b> </p> <p>77 00 867 360</p>	<p><b>71-34359-00</b> 77 00 273 486</p>	<p><b>81-15855-40</b> </p> <p>77 00 273 776 35x47 A RD FPM</p> <p><b>81-18304-50</b> </p> <p>77 00 859 692 80x100 A SL LD FPM</p> <p><b>81-17539-50 N</b></p> <p>77 00 749 395 30x42 A SL RD FPM</p>

DACIA

Ltr.	Motor	Power	Models	Year	Image 1	Image 2	Image 3	Image 4	Image 5	Image 6	Image 7	Image 8	Image 9	Image 10	Image 11	Image 12
1,5	K9K 612 K9K 626	55 kW (75 PS)	DOKKER LOGAN II SANDERO II	10/12												
								<b>04-10346-01</b>  82 00 862 244 77,5 Ø 0,8 mm MLS	<b>61-37930-10</b> 82 00 862 244 77,5 Ø 0,8 mm MLS 	<b>14-32230-01</b> 77 01 477 395 		<b>12-33512-02</b> 82 00 496 321 (16x)  8x <b>70-33512-00</b> 82 00 496 321 	<b>71-37214-10</b> 82 00 414 346 	<b>71-38517-00</b> 82 00 379 654 	<b>81-36957-00</b> 77 01 475 009 35x47 A SL RD PTFE ACM  <b>81-35051-00</b> 77 01 473 544 80x100 A LD PTFE ACM  <b>81-38506-00</b> 28x42 A SL RD PTFE (Polytetrafluorethylen)/ACM (Polyacryl-Kautschuk) 	
1,5	K9K 612 K9K 626	55-66 kW (75-90 PS)	DOKKER DUSTER LOGGY LOGAN II LOGAN MCV II SANDERO II	10/10				<b>04-10346-01</b>  82 00 862 244 77,5 Ø 0,8 mm MLS 	<b>61-37930-10</b> 82 00 862 244 77,5 Ø 0,8 mm MLS 	<b>14-32230-01</b> 77 01 477 395 	<b>71-40854-00</b> 77 01 070 607 	<b>12-33512-02</b> 82 00 496 321 (16x)  8x <b>70-33512-00</b> 82 00 496 321 	<b>71-37214-10</b> 82 00 414 346 	<b>71-38517-00</b> 82 00 379 654 	<b>81-36957-00</b> 77 01 475 009 35x47 A SL RD PTFE ACM  <b>81-35051-00</b> 77 01 473 544 80x100 A LD PTFE ACM  <b>81-38506-00</b> 28x42 A SL RD PTFE (Polytetrafluorethylen)/ACM (Polyacryl-Kautschuk) 	

DACIA															
Ltr.															
1,5	K9K 656 K9K 658 K9K 666 K9K 667	66-81 kW (90-110 PS)	DUSTER LODGY	03/12											
					<p><b>02-37930-01</b> 77 01 479 013</p>				<p><b>61-37930-10</b> 82 00 862 244 77,5 Ø 0,8 mm MLS</p>	<p><b>14-32230-01</b> 77 01 477 395</p>	<p><b>71-40854-00</b> 77 01 070 607</p>	<p><b>12-33512-04</b> 82 00 496 321 (8x)</p>	<p><b>71-37214-10</b> </p> <p>82 00 414 346</p>	<p><b>71-38517-00</b> 82 00 379 654  160801</p>	<p><b>81-36957-00 K</b> </p> <p>77 01 475 009 35x47 A SL RD PTFE ACM</p> <p><b>81-35051-00 K</b> </p> <p>77 01 473 544 80x100 A LD PTFE ACM</p> <p><b>81-38506-00 N</b></p> <p>28x42 A SL RD PTFE (Polytetrafluorethylen)/ACM (Polyacryl-Kautschuk)</p>
1,5	K9K 666	80 kW (109 PS)	LODGY	06/15											
					<p><b>02-37930-01</b> 77 01 479 013</p>		<p><b>04-10328-01</b> </p>	<p><b>61-37930-10</b> 82 00 862 244 77,5 Ø 0,8 mm MLS</p>	<p><b>14-32230-01</b> 77 01 477 395</p>	<p><b>71-40854-00</b> 77 01 070 607</p>	<p><b>12-33512-04</b> 82 00 496 321 (8x)</p>	<p><b>71-37214-10</b> </p> <p>82 00 414 346</p>	<p><b>71-38517-00</b> 82 00 379 654  160801</p>	<p><b>81-36957-00 K</b> </p> <p>77 01 475 009 35x47 A SL RD PTFE ACM</p> <p><b>81-35051-00 K</b> </p> <p>77 01 473 544 80x100 A LD PTFE ACM</p> <p><b>81-38506-00 N</b></p> <p>28x42 A SL RD PTFE (Polytetrafluorethylen)/ACM (Polyacryl-Kautschuk)</p>	

DACIA

Ltr.  1,5 K9K 790 48 kW (65 PS)  LOGAN  09/05



1,5 K9K 790 48 kW (65 PS) LOGAN 09/05

**02-36975-01**  
77 01 476 729  
+82 00 351 353

**08-34359-02**

**04-10053-01** 

**61-10063-00**  
77,5 Ø  
MLS

**61-10063-10**  
77,5 Ø  
MLS

**14-32230-01**  
77 01 477 395

**71-36442-00**  
82 00 117 388

**12-31306-07**  
77 01 109 840 (8x)

**70-31306-00**  
77 00 109 840

8x

**71-37214-10** 

82 00 414 346

**71-34359-00**  
77 00 273 486

**81-36957-00** 

77 01 475 009  
35x47  
A SL RD PTFE ACM

**81-35051-00** 

77 01 473 544  
80x100  
A LD PTFE ACM

**81-38506-00** **N**

28x42  
A SL RD PTFE  
(Polytetrafluorethylen)/ACM  
(Polyacryl-Kautschuk)

1,5 K9K 790 48 kW (65 PS) SANDERO 11/08

**02-36975-01**  
77 01 476 729  
+82 00 351 353

**08-34359-02**

**04-10053-01** 

**61-10063-00**  
77,5 Ø  
MLS

**61-10063-10**  
77,5 Ø  
MLS

**14-32230-01**  
77 01 477 395

**71-36442-00**  
82 00 117 388

**71-37214-10** 

82 00 414 346

**71-34359-00**  
77 00 273 486

**81-36957-00** 

77 01 475 009  
35x47  
A SL RD PTFE ACM

**81-35051-00** 

























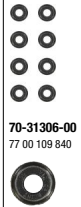

77 01 473 544  
80x100  
A LD PTFE ACM

**81-38506-00** **N**











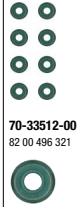

28x42  
A SL RD PTFE  
(Polytetrafluorethylen)/ACM  
(Polyacryl-Kautschuk)

**DACIA**

Ltr.  1,5 K9K 792 50 kW (68 PS) LOGAN SANDERO  01/06 

										
	<p><b>02-36975-01</b> 77 01 476 729 +82 00 351 353</p> 	<p><b>08-38517-01</b></p> 	<p><b>04-10329-01</b> </p> 	<p><b>61-10063-00</b> 77,5 Ø MLS</p> <p><b>61-10063-10</b> 77,5 Ø MLS</p> 	<p><b>14-32230-01</b> 77 01 477 395</p> 	<p><b>71-36442-00</b> 82 00 117 388</p> 	<p><b>12-31306-07</b> 77 01 109 840 (8x)</p> <p><b>70-31306-00</b> 77 00 109 840</p>  <p>8x</p>	<p><b>71-37214-10</b> </p> <p>82 00 414 346</p> 	<p><b>71-38517-00</b> 82 00 379 654</p> 	<p><b>81-36957-00</b> </p> <p>77 01 475 009 35x47 A SL RD PTFE ACM</p>  <p><b>81-35051-00</b> </p> <p>77 01 473 544 80x100 A LD PTFE ACM</p>  <p><b>81-38506-00</b> <b>N</b></p> <p>28x42 A SL RD PTFE (Polytetrafluorethylen)/ACM (Polyacryl-Kautschuk)</p> 

1,5 K9K 796 63 kW (86 PS) DUSTER 04/10-01/18

	<p><b>02-36975-01</b> 77 01 476 729 +82 00 351 353</p> 	<p><b>08-38517-01</b></p> 		<p><b>61-10063-00</b> 77,5 Ø MLS</p> <p><b>61-10063-10</b> 77,5 Ø MLS</p> 	<p><b>14-32230-01</b> 77 01 477 395</p> 	<p><b>71-36442-00</b> 82 00 117 388</p> 	<p><b>12-33512-04</b> 82 00 496 321 (8x)</p> <p><b>70-33512-00</b> 82 00 496 321</p>  <p>8x</p>	<p><b>71-37214-10</b> </p> <p>82 00 414 346</p> 	<p><b>71-38517-00</b> 82 00 379 654</p> 	<p><b>81-36957-00</b> </p> <p>77 01 475 009 35x47 A SL RD PTFE ACM</p>  <p><b>81-35051-00</b> </p> <p>77 01 473 544 80x100 A LD PTFE ACM</p>  <p><b>81-38506-00</b> <b>N</b></p> <p>28x42 A SL RD PTFE (Polytetrafluorethylen)/ACM (Polyacryl-Kautschuk)</p> 
--	--	--	--	---	---	---	--	--	---	--

DACIA														
Ltr.														
1,5 K9K 796	LOGAN SANDERO	09/07	63 kW (86 PS)											
					<p><b>02-36975-01</b> 77 01 476 729 +82 00 351 353</p>	<p><b>08-38517-01</b></p>	<p><b>04-10329-01</b> </p>	<p><b>61-10063-00</b> 77,5 Ø MLS</p> <p><b>61-10063-10</b> 77,5 Ø MLS</p>	<p><b>14-32230-01</b> 77 01 477 395</p>	<p><b>71-36442-00</b> 82 00 117 388</p>	<p><b>12-33512-04</b> 82 00 496 321 (8x)</p> <p><b>70-33512-00</b> 82 00 496 321</p> <p>8x</p>	<p><b>71-37214-10</b> </p> <p>82 00 414 346</p>	<p><b>71-38517-00</b> 82 00 379 654</p>	<p><b>81-36957-00</b> </p> <p>77 01 475 009 35x47 A SL RD PTFE ACM</p> <p><b>81-35051-00</b> </p> <p>77 01 473 544 80x100 A LD PTFE ACM</p> <p><b>81-38506-00</b> </p> <p>28x42 A SL RD PTFE (Polytetrafluorethylen)/ACM (Polyacryl-Kautschuk)</p>
1,5 K9K 830 K9K 838	DOKKER DUSTER LOGAN II LOGAN MCV II SANDERO II	04/10	55-63 kW (75-86 PS)											
					<p><b>02-36975-01</b> 77 01 476 729 +82 00 351 353</p>			<p><b>61-10063-00</b> 77,5 Ø MLS</p> <p><b>61-10063-10</b> 77,5 Ø MLS</p>	<p><b>14-32230-01</b> 77 01 477 395</p>	<p><b>71-36442-00</b> 82 00 117 388</p>	<p><b>12-33512-04</b> 82 00 496 321 (8x)</p> <p><b>70-33512-00</b> 82 00 496 321</p> <p>8x</p>	<p><b>71-37214-10</b> </p> <p>82 00 414 346</p>	<p><b>71-38517-00</b> 82 00 379 654</p>	<p><b>81-36957-00</b> </p> <p>77 01 475 009 35x47 A SL RD PTFE ACM</p> <p><b>81-35051-00</b> </p> <p>77 01 473 544 80x100 A LD PTFE ACM</p> <p><b>81-38506-00</b> </p> <p>28x42 A SL RD PTFE (Polytetrafluorethylen)/ACM (Polyacryl-Kautschuk)</p>

DACIA

Ltr.	Motor	Power	Model	Year	Image 1	Image 2	Image 3	Image 4	Image 5	Image 6	Image 7	Image 8	Image 9	Image 10	Image 11	Image 12
1,5	K9K 846 K9K 884 K9K 892 K9K 894 K9K 896 K9K 898	55-81 kW (75-110 PS)	DUSTER LOGGY LOGAN SANDERO	05/10												
						<p><b>02-37930-01</b> 77 01 479 013</p>		<p><b>04-10346-01</b> </p>	<p><b>61-37930-10</b> 82 00 862 244 77,5 Ø 0,8 mm MLS</p>	<p><b>14-32230-01</b> 77 01 477 395</p>	<p><b>71-40854-00</b> 77 01 070 607</p>	<p><b>12-33512-04</b> 82 00 496 321 (8x)</p> <p>8x</p>	<p><b>71-37214-10</b> </p> <p>82 00 414 346</p>	<p><b>71-38517-00</b> 82 00 379 654</p>	<p><b>81-36957-00 K</b> </p> <p>77 01 475 009 35x47 A SL RD PTFE ACM</p> <p><b>81-35051-00 K</b> </p> <p>77 01 473 544 80x100 A LD PTFE ACM</p> <p><b>81-38506-00 N</b></p> <p>28x42 A SL RD PTFE (Polytetrafluorethylen)/ACM (Polyacryl-Kautschuk)</p>	
1,5	K9K 856 K9K 858	80-81 kW (109-110 PS)	DUSTER	10/10												
						<p><b>02-37930-01</b> 77 01 479 013</p>		<p><b>04-10346-01</b> </p>	<p><b>61-37930-10</b> 82 00 862 244 77,5 Ø 0,8 mm MLS</p>	<p><b>14-32230-01</b> 77 01 477 395</p>	<p><b>71-40854-00</b> 77 01 070 607</p>	<p><b>12-33512-04</b> 82 00 496 321 (8x)</p>	<p><b>71-37214-10</b> </p> <p>82 00 414 346</p>	<p><b>71-38517-00</b> 82 00 379 654  160801</p>	<p><b>81-36957-00 K</b> </p> <p>77 01 475 009 35x47 A SL RD PTFE ACM</p> <p><b>81-35051-00 K</b> </p> <p>77 01 473 544 80x100 A LD PTFE ACM</p> <p><b>81-38506-00 N</b></p> <p>28x42 A SL RD PTFE (Polytetrafluorethylen)/ACM (Polyacryl-Kautschuk)</p>	



DACIA													
Ltr.													
1,5 K9K 872 K9K 874	55-85 kW (75-116 PS)	DOKKER DUSTER LOGGY LOGAN II SANDERO SANDERO II	10/12										
1,5 K9K 872 K9K 874	85 kW (116 PS)	DUSTER	10/17										
1,6 H4M 430 H4M 438 H4M 730 H4M 738 H4M 740	75-84 kW (102-115 PS)	DOKKER DUSTER LOGGY LOGAN	04/15										

**DACIA**

Ltr. K4M 606 77 kW (105 PS) DUSTER 06/10

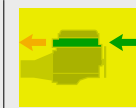

1,6 K4M 606 77 kW (105 PS) DUSTER 06/10

**02-31675-01**  
77 01 471 886

**61-31675-00**  
77 00 112 739  
80,5 Ø  
MLS

**14-32157-01**  
77 01 471 373

**70-31414-10**

**12-34406-01**  
77 00 103 938 (16x)

**70-34406-00**  
77 00 103 938

**71-33835-00** **71-36182-00** 4x

**71-35861-00** 16x  
82 00 365 915

**71-38517-00**  
82 00 379 654

**81-15855-40** **81-18304-50**

77 00 273 776  
35x47  
A RD FPM

77 00 859 692  
80x100  
A SL LD FPM

**81-38506-00** **N**  
28x42  
A SL RD PTFE  
(Polytetrafluorethylen)/ACM  
(Polyacryl-Kautschuk)

**81-38507-00** **N**  
33x42  
A SL RD PTFE ACM

1,6 K4M 616 77 kW (105 PS) DUSTER 04/11-01/18  
K4M 642

**02-31675-01**  
77 01 471 886

**61-31675-00**  
77 00 112 739  
80,5 Ø  
MLS

**14-32157-01**  
77 01 471 373

**70-31414-10**

**12-34406-01**  
77 00 103 938 (16x)

**70-34406-00** 16x  
77 00 103 938

**71-33835-00** **71-36182-00** 4x

**71-35861-00** 16x  
82 00 365 915

**71-34359-00**  
77 00 273 486

**81-36957-00**

77 01 475 009  
35x47  
A SL RD PTFE ACM

**81-18304-50**



























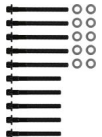

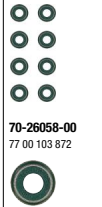

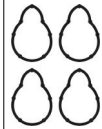
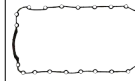





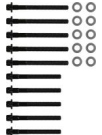

77 00 859 692  
80x100  
A SL LD FPM

**81-38506-00** **N** 2x  
28x42  
A SL RD PTFE  
(Polytetrafluorethylen)/ACM  
(Polyacryl-Kautschuk)

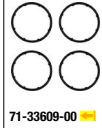
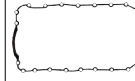
DACIA













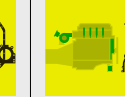

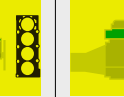
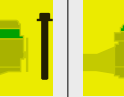
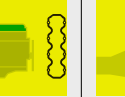

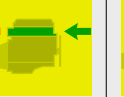









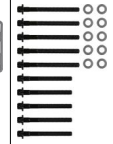
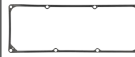

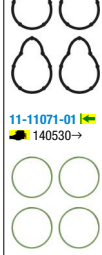
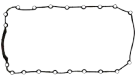
Ltr.	Motor	Power	Model	Year	Image 1	Image 2	Image 3	Image 4	Image 5	Image 6	Image 7	Image 8	Image 9	Image 10	Image 11	Image 12	
1,6	K4M 690 K4M 696	77 kW (105 PS)	DUSTER LOGAN LOGAN MCV SANDERO SANDERO II	02/06													
						<b>02-31675-01</b> 77 01 471 886 				<b>61-31675-00</b> 77 00 112 739 80,5 Ø MLS 	<b>14-32157-01</b> 77 01 471 373 	<b>70-31414-10</b> 	<b>12-34406-01</b> 77 00 103 938 (16x) 	<b>71-33835-00</b> 77 00 105 852 	<b>71-35861-00</b> 82 00 365 915 	<b>71-34359-00</b> 77 00 273 486 	<b>81-15855-40</b> 77 00 273 776 35x47 A RD FPM 
												<b>70-34406-00</b> 77 00 103 938 	16x 				<b>81-18304-50</b> 77 00 859 692 80x100 A SL LD FPM 
																	<b>81-38506-00</b> <b>N</b> 2x 28x42 A SL RD PTFE (Polytetrafluorethylen)/ACM (Polyacryl-Kautschuk) 
1,6	K4M 694 K4M 842	77 kW (105 PS)	DUSTER SANDERO	01/11													
						<b>02-31675-01</b> 77 01 471 886 				<b>61-31675-00</b> 77 00 112 739 80,5 Ø MLS 	<b>14-32157-01</b> 77 01 471 373 	<b>70-31414-10</b> 	<b>12-34406-01</b> 77 00 103 938 (16x) 	<b>71-33835-00</b> 77 00 105 852 	<b>71-37913-00</b> 4x 	<b>71-34359-00</b> 77 00 273 486 	<b>81-15855-40</b> 77 00 273 776 35x47 A RD FPM 
													<b>70-34406-00</b> 77 00 103 938 	16x 	<b>71-35861-00</b> 82 00 365 915 		<b>81-18304-50</b> 77 00 859 692 80x100 A SL LD FPM 
																	<b>81-38506-00</b> <b>N</b> 2x 28x42 A SL RD PTFE (Polytetrafluorethylen)/ACM (Polyacryl-Kautschuk) 

DACIA













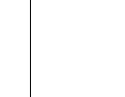
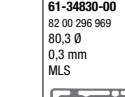

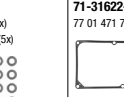
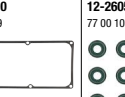
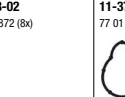
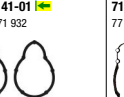
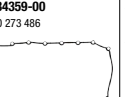

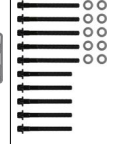
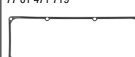

<p>Ltr. </p>	<p>1,6 K7M 690 K7M 718 K7M 732</p>	<p>62-77 kW (84-105 PS)</p>	<p>LOGAN SANDERO</p>	<p>08/04 </p>											
<p>1,6 K7M 690 K7M 718 K7M 732</p>	<p>62-77 kW (84-105 PS)</p>	<p>LOGAN SANDERO</p>	<p>08/04 </p>	<p><b>02-34830-01</b> 60 01 548 043 +77 01 471 932</p> 	<p><b>08-34359-01</b></p> 			<p><b>61-34830-00</b> 82 00 296 969 80,3 Ø 0,3 mm MLS</p> 	<p><b>14-32089-01</b> 77 00 738 986 (5x) +77 00 738 987 (5x)</p> 	<p><b>71-31622-10</b> 77 01 471 719</p> 	<p><b>12-26058-02</b> 77 00 103 872 (8x)</p> 	<p><b>11-37141-01</b>  77 01 471 932</p> 	<p><b>71-34359-00</b> 77 00 273 486</p> 	<p><b>81-15855-40</b>  77 00 273 776 35x47 A RD FPM</p>  <p><b>81-18304-50</b>  77 00 859 692 80x100 A SL LD FPM</p>  <p><b>81-17539-50</b> <b>N</b> 77 00 749 395 30x42 A SL RD FPM</p> 	
<p>1,6 K7M 710</p>	<p>64 kW (87 PS)</p>	<p>LOGAN LOGAN MCV II SANDERO</p>	<p>09/04</p>	<p><b>02-34830-01</b> 60 01 548 043 +77 01 471 932</p> 	<p><b>08-34359-01</b></p> 			<p><b>61-34830-00</b> 82 00 296 969 80,3 Ø 0,3 mm MLS</p> 	<p><b>14-32089-01</b> 77 00 738 986 (5x) +77 00 738 987 (5x)</p> 	<p><b>71-31622-10</b> 77 01 471 719</p>  <p><b>71-31622-20</b> 77 00 739 165</p> 	<p><b>12-26058-02</b> 77 00 103 872 (8x)</p> 	<p><b>11-34434-01</b>  77 01 471 816</p> 	<p><b>71-34359-00</b> 77 00 273 486</p> 	<p><b>81-15855-40</b>  77 00 273 776 35x47 A RD FPM</p>  <p><b>81-18304-50</b>  77 00 859 692 80x100 A SL LD FPM</p>  <p><b>81-17539-50</b> <b>N</b> 77 00 749 395 30x42 A SL RD FPM</p> 	

DACIA

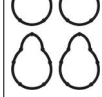
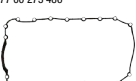
Ltr.  1,6 K7M 800 62 kW (84 PS)  LOGAN SANDERO  05/10 **[NEW]**

											
	02-11364-01			61-34830-00 82 00 296 969 80,3 Ø 0,3 mm MLS	14-32089-01 77 00 738 986 (5x) +77 00 738 987 (5x)  110621	71-31622-10 77 01 471 719	12-26058-02 77 00 103 872 (8x)	11-37141-01  77 01 471 932  140529	71-34359-00 77 00 273 486	81-36957-00  77 01 475 009 35x47 A SL RD PTFE ACM	81-18304-50  77 00 859 692 80x100 A SL LD FPM  120422
											
								70-26058-00 77 00 103 872	8x	81-18304-50  77 01 473 544 80x100 A LD PTFE ACM	81-35051-00  77 01 473 544 80x100 A LD PTFE ACM
								11-11071-01   140530→		81-17539-50 <b>N</b> 77 00 749 395 30x42 A SL RD FPM	
								71-21684-00 			

1,6 K7M 812 61-63 kW (83-86 PS)  DOKKER LODGY LOGAN SANDERO II 03/12

											
	02-34830-01 60 01 548 043 +77 01 471 932			61-34830-00 82 00 296 969 80,3 Ø 0,3 mm MLS	14-32089-01 77 00 738 986 (5x) +77 00 738 987 (5x)	71-31622-10 77 01 471 719	12-26058-02 77 00 103 872 (8x)	11-37141-01  77 01 471 932	71-34359-00 77 00 273 486	81-33632-00  35x47 A SL RD FPM	81-18304-50  77 00 859 692 80x100 A SL LD FPM
											
								71-33609-00  77 00 867 360	8x	81-18304-50  77 00 859 692 80x100 A SL LD FPM	81-17539-50 <b>N</b> 77 00 749 395 30x42 A SL RD FPM
											

DACIA													
Ltr.			<b>1</b>										
1,9 F8Q 600	44-48 kW (60-65 PS)			<p><b>02-26391-07</b> 77 01 466 719</p>	<p><b>08-34414-02</b> 77 01 470 176 +77 00 114 424</p>		<p><b>61-33685-00</b> 82 00 188 390 81 Ø 1,4 mm</p> <p><b>61-33685-10</b> 82 00 188 114 81 Ø 1,5 mm</p> <p><b>61-33685-20</b> 82 00 188 391 81 Ø 1,6 mm</p>	<p><b>14-32161-01</b> 77 00 865 991 (10x)</p>	<p><b>71-26391-00</b> 77 00 719 666</p>	<p><b>12-25837-01</b> 77 00 737 124 (8x)</p> <p><b>70-25837-00</b> 77 00 737 124</p> <p>8x</p>	<p><b>71-33647-00</b> </p> <p>77 00 854 252</p>	<p><b>71-34414-00</b> 82 00 282 199</p>	<p><b>81-34413-00 K</b> </p> <p>42x54 A SL RD FPM/ACM</p> <p><b>81-34417-10 K</b> </p> <p>85x105 A SL LD FPM</p> <p><b>81-26389-30 N</b> 25x42 A SL RD FPM</p>
1,9 F8Q 630 F8Q 636	46-48 kW (63-65 PS)	PICK UP SOLENZA	02/00	<p><b>02-26391-03</b> 77 01 462 816</p>	<p><b>08-34414-02</b> 77 01 470 176 +77 00 114 424</p>		<p><b>61-33685-00</b> 82 00 188 390 81 Ø 1,4 mm</p> <p><b>61-33685-10</b> 82 00 188 114 81 Ø 1,5 mm</p> <p><b>61-33685-20</b> 82 00 188 391 81 Ø 1,6 mm</p>	<p><b>14-32161-01</b> 77 00 865 991 (10x)</p>	<p><b>71-26391-00</b> 77 00 719 666</p>	<p><b>12-25837-01</b> 77 00 737 124 (8x)</p> <p><b>70-25837-00</b> 77 00 737 124</p> <p>8x</p>	<p><b>71-31568-00</b> </p> <p>77 00 103 849</p>	<p><b>71-34414-00</b> 82 00 282 199</p>	<p><b>81-34413-00 K</b> </p> <p>42x54 A SL RD FPM/ACM</p> <p><b>81-34417-10 K</b> </p> <p>85x105 A SL LD FPM</p> <p><b>81-26389-30 N</b> 25x42 A SL RD FPM</p>

# Haftungsausschluss

## (für Katalog)

**Alle Angaben in unserem Katalog** wurden von uns sorgfältig geprüft, sind jedoch unverbindlich. Ersatzansprüche wegen Katalogangaben werden von uns nicht anerkannt. Der Käufer ist selbst verpflichtet, zu prüfen, ob unsere Teile für seine Zwecke geeignet sind. In allen Zweifelsfällen sollte Rücksprache mit unserem technischen Kundendienst erfolgen **Tel. +49 731 7046 999**.

**Technische Weiterentwicklungen** oder Änderungen bleiben vorbehalten, soweit damit keine Nachteile für den Kunden verbunden sind.

**Angaben, Namens- und Markenzeichen**, Beschreibungen, Nummern von Fahrzeugnummern und Herstellerzeichen, Original-Ersatzteilnummern der Fahrzeug- und Motorenhersteller u. a. sind ausschließlich für interne Zwecke gedacht. Solche Kennzeichnungen dürfen Fahrzeugbesitzern gegenüber nicht verwendet werden.

**Wir weisen ausdrücklich darauf hin**, dass alle von uns gelieferten Teile von geschultem Fachpersonal einzubauen sind. Reinz haftet für Fehler in diesem Katalog nur, wenn diese für den Kunden nicht offenbar erkennbar sind sowie nur bei Vorsatz und grober Fahrlässigkeit von Reinz, eines Vertreters oder eines Erfüllungsgehilfen. Dieser Haftungsausschluss gilt nicht im Rahmen

des Anwendungsbereichs des Produkthaftungsgesetzes und nicht bei Verletzung von Körper, Leben und Gesundheit, sowie bei der Verletzung von sog. Kardinalpflichten. Darüber hinaus ist unsere Haftung für Schäden, insbesondere für Personen-, Sach- oder Vermögensschäden, die unmittelbar oder mittelbar im Zusammenhang mit der Nutzung dieses Kataloges auftreten, sowie für nicht voraussehbare Schäden ausgeschlossen.

**Reinz ist Inhaber aller Schutzrechte** an den in diesem Katalog gespeicherten Daten. Kopie, Nachdruck, ganze oder teilweise Übernahme der Inhalte und Vervielfältigung, auch auszugsweise, ist nur mit unserer vorheriger schriftlicher Zustimmung sowie mit unserem Urheberrechtsvermerk zulässig.

Für Bestellungen, welche ab dem Erscheinungsdatum eines neuen Katalogs getätigt werden, sind alleine die Angaben des neuen Katalogs maßgeblich. Auf Angaben im Vorkatalog kann bei Neubestellungen nicht mehr zurückgegriffen werden.

**Sofern Sie noch Fragen haben, bitten wir Sie, sich mit uns in Verbindung zu setzen.**

VictorReinz.com/AGB

# Exclusion of Liability

## (for catalog)

**All details in our catalog** have been thoroughly checked by us but are however not binding. Right to damages on account of catalog details will not be recognized. The purchaser is obliged to check if our parts are suitable for their use. In all doubtful cases, the purchaser should consult our technical customer service under **+49 731 7046 999**.

**We reserve the right** to further technical developments or changes as long as no disadvantage for the customer results.

**Details, name and trademarks**, descriptions, numbers from vehicle numbers and manufacturer symbols, original vehicle replacement part numbers and engine manufacturer etc. are solely for internal use. Such labels must not be used with vehicle owners.

**We specifically point out** that all parts supplied by us must be assembled by trained specialists.

**Reinz is liable for mistakes** in this catalog only when they are not clearly recognizable for the customer, as well as by intent or gross negligence on the part of Reinz, its representative or vicarious agent. This exclusion of liability does not apply within the framework of the field of

application of the product liability laws and not by bodily harm, life and health, as well as by violation of cardinal duties. In addition, our liability for damages, especially personal, property or financial damages that occur directly or indirectly as a result of the use of this catalog, as well as non-foreseeable damages are excluded.

**Reinz is the owner of all patent rights** on the data stored in this catalog. Copies, reprints, whole or partial takeover of the contents and duplication even in excerpts are only permissible with our prior written approval, as well as with our copyright note.

**For orders placed after the publication date** of a new catalog, only the details in the new catalog are binding and no fall back to details in the previous catalog is possible.

**In case you have further questions, do not hesitate to contact us.**

VictorReinz.com/AGB





**VictorReinz.com**

**reinz.info@dana.com**

**Technical Hotline +49 (0)731 7046-9 99**

**REINZ-Dichtungs-GmbH**

Reinzstrasse 3-7  
89233 Neu-Ulm  
Germany  
+49 (0)731 7046-0

***VICTOR REINZ***<sup>®</sup>

---

