

**VICTOR REINZ®**

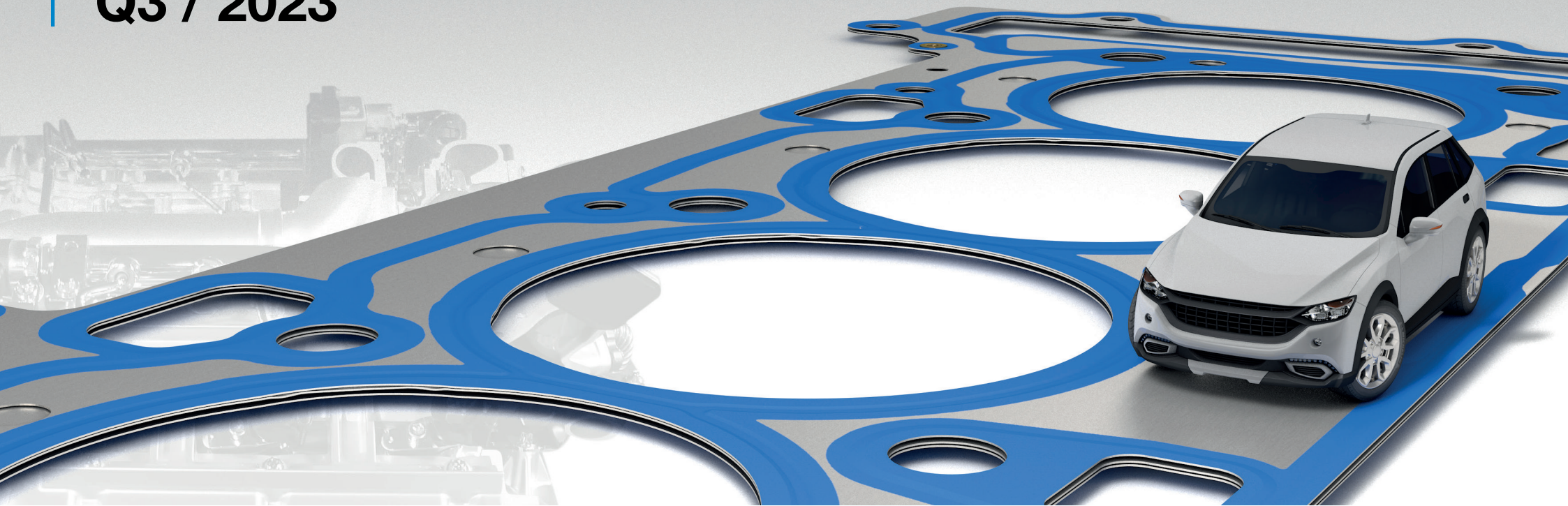

**JAGUAR  
Q3 / 2023**



**[VictorReinz.com/online-catalog](https://VictorReinz.com/online-catalog)**

# Victor Reinz®

at a Glance



## Online Catalog

[VictorReinz.com/online-catalog](https://VictorReinz.com/online-catalog)



## Newsletter

[VictorReinz.com/EN/News/Newsletter.aspx?region](https://VictorReinz.com/EN/News/Newsletter.aspx?region)



## Youtube

[www.youtube.com/user/VictorReinzSealingEN](https://www.youtube.com/user/VictorReinzSealingEN)



## Catalog News

[VictorReinz.com/news](https://VictorReinz.com/news)



## Technical Service Information

[VictorReinz.com/tsi](https://VictorReinz.com/tsi)



## Facebook

[www.facebook.com/VictorReinzParts](https://www.facebook.com/VictorReinzParts)



## Just seal it!

[VictorReinz.com/jsi](https://VictorReinz.com/jsi)



## Technical Datasheet

[VictorReinz.com/jsi-datasheet](https://VictorReinz.com/jsi-datasheet)



## LinkedIn

[www.linkedin.com/showcase/victor-reinz-emea](https://www.linkedin.com/showcase/victor-reinz-emea)



## Safety Datasheet

[VictorReinz.com/jsi-datasheet](https://VictorReinz.com/jsi-datasheet)



## Homepage

[VictorReinz.com](https://VictorReinz.com)



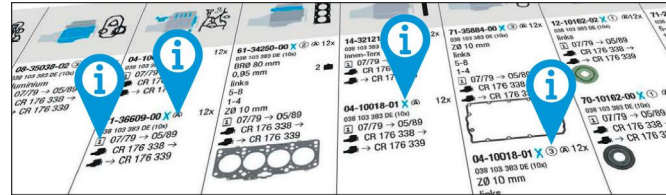

[VictorReinz.com/catalog-info](https://www.victorreinz.com/catalog-info)

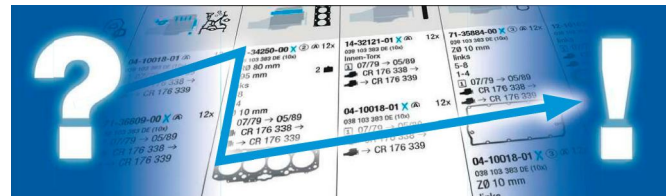

[VictorReinz.com/catalog-how-to-use](https://www.victorreinz.com/catalog-how-to-use)

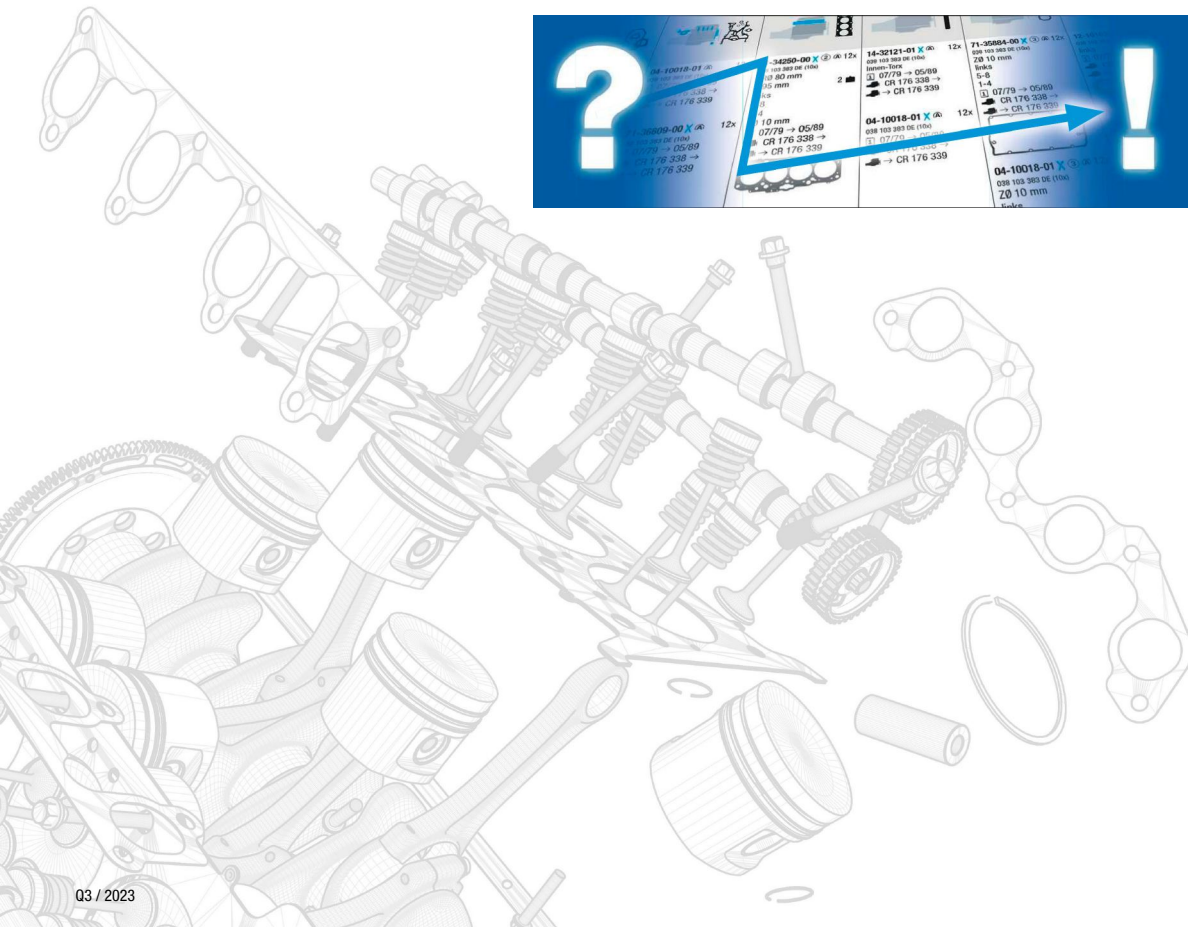

# JAGUAR



**0-9**

204DTA ..... 8  
 204DTD ..... 8  
 204PT ..... 8  
 224DT ..... 9  
 306DT ..... 10  
 306PS ..... 11  
 508PN ..... 13  
 508PS ..... 13

**A**

AJ133G2 ..... 13  
 AJ20D4 ..... 5  
 AJ20D6 ..... 11  
 AJ20P4 ..... 5  
 AJ21D4 ..... 6  
 AJ6 ..... 9-10  
 AJ8 ..... 11  
 AJ8FR ..... 12  
 AJ8FT ..... 12  
 AJD ..... 10  
 AJV6D ..... 10

**F**

FMBA ..... 6-7  
 FMBB ..... 6-7

**P**

PT204 ..... 7

**Q**

QJBA ..... 9

**R**

R4-X404 ..... 7

**Y**



YB (AJ-V6) ..... 8

JAGUAR



















Ltr.	Motor	Power	Model	Page	Image 1	Image 2	Image 3	Image 4	Image 5	Image 6	Image 7	Image 8	Image 9	Image 10	Image 11
2,0	AJ20D4	120-150 kW (163-204 PS)	E-PACE 2.0 F-PACE 2.0	10/20											
								<p><b>61-10299-00</b> JDE 36767 84 Ø 1,3 mm MLS</p> <p><b>61-10299-10</b> JDE 36768 84 Ø 1,4 mm MLS</p> <p><b>61-10299-20</b> JDE 36769 84 Ø 1,5 mm MLS</p> <p><b>61-10299-30</b> JDE 36770 84 Ø 1,6 mm MLS</p> <p><b>61-10299-40</b> JDE 36771 84 Ø 1,7 mm MLS</p>	<p><b>14-13249-01</b> JDE 36434 (10x)</p>	<p><b>71-13233-00</b> JDE 38499</p>	<p><b>12-13246-01</b> JDE 37047 (16x)</p> <p><b>70-13246-00</b> JDE 37047</p> <p>16x</p>	<p><b>11-77637-01</b> </p> <p>JDE 38156 (8x)</p> <p><b>71-13214-00</b> </p> <p>JDE 38416</p>	<p><b>70-31414-10</b></p>	<p><b>81-10503-00</b> </p> <p>JDE 38485 PTFE</p> <p><b>81-10505-00</b> </p> <p>JDE 39481 92x109 AB SL LD PTFE ACM</p>	
2,0	AJ20P4	147-221 kW (200-300 PS)	E-PACE 2.0	11/20				<p><b>61-10765-00</b> JDE 38673 84 Ø 1,05 mm MLS</p>	<p><b>14-17603-01</b> JDE 38675 (10x)</p>	<p><b>71-10259-00</b> </p> <p>JDE 39559</p> <p><b>71-17602-00</b> </p> <p>JDE 38593</p>	<p><b>12-17787-01</b> JDE 40288 (16x)</p> <p><b>70-17787-00</b> JDE 40288</p> <p>16x</p>	<p><b>71-17585-00</b> </p> <p>TZR 26107</p> <p>4x</p>	<p><b>70-31414-10</b></p>	<p><b>81-10505-00</b> </p> <p>JDE 39481 92x109 AB SL LD PTFE ACM</p>	







**JAGUAR**



Ltr.   









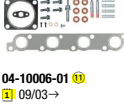

2,0 FMBA FMBB 96 kW (130 PS) X-TYPE 2.0D 02/04-12/09 **1**

										
	02-33758-04	08-35536-01	04-10006-01 	61-35425-00 87 Ø 1,1 mm MLS 1  61-35425-10 87 Ø 1,15 mm MLS 2  61-35425-20 87 Ø 1,2 mm MLS 3 	14-32204-01	15-33758-01	12-35549-01 C2S 46933 (16x)	71-35539-00  8x 71-34026-00 	15-35536-01	81-90014-00  K PTFE 81-90013-00  K PTFE 81-35556-00 <b>N</b> 36x50 A SL LD PTFE

2,0 PT204 147-297 kW (200-404 PS) E-PACE 2.0 E-PACE 2.0 Flexfuel F-PACE 2.0 F-TYPE 2.0 XE 2.0 XF 2.0 02/17

				61-10765-00 JDE 38673 84 Ø 1,05 mm MLS	14-17603-01 JDE 38675 (10x)	71-10259-00  JDE 39559	12-17787-01 JDE 40288 (16x)	71-17585-00  4x T2R 26107	70-31414-10	81-10503-00  K PTFE 81-10505-00  K JDE 39481 92x109 AB SL LD PTFE ACM
--	--	--	--	--	--------------------------------	--	--------------------------------	---	-------------	--

















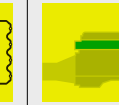
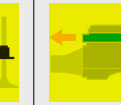
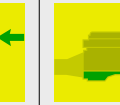











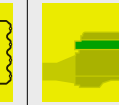
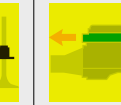
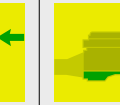







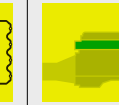
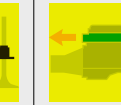
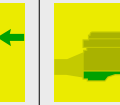

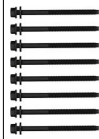
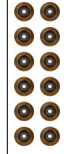

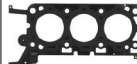
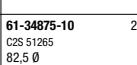
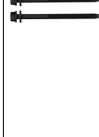
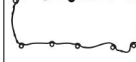



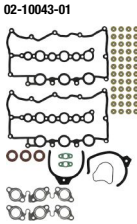

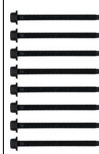
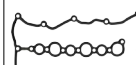

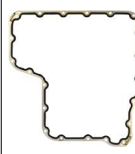









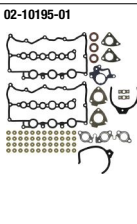

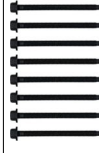
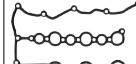

2,0 R4-X404 96 kW (131 PS) 02-33758-01  05/02  
02-33758-04  06/02→

				61-35425-00 87 Ø 1,1 mm MLS 1  61-35425-10 87 Ø 1,15 mm MLS 2  61-35425-20 87 Ø 1,2 mm MLS 3 	14-32204-01	15-33758-01	12-35549-01 C2S 46933 (16x)	71-35539-00  8x 71-35486-00  05/02 71-34026-00  06/02→	15-35536-01	81-90014-00  K PTFE 81-90013-00  K PTFE 81-35556-00 <b>N</b> 36x50 A SL LD PTFE
--	--	--	---	---	-------------	-------------	--------------------------------	---	-------------	---



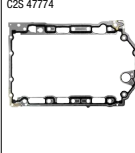

JAGUAR														
Ltr.														
2,2	QJBA	107-114 kW X-TYPE 2.2 D (146-155 PS)	10/05-12/09											
					02-33758-04 	08-35536-01 		61-35425-00 87 Ø 1,1 mm MLS 1 	14-32204-01 	15-33758-01 	12-35549-01 C2S 46933 (16x) 	71-34026-00 	15-35536-01 	81-90014-00 K PTFE 
								61-35425-10 87 Ø 1,15 mm MLS 2 		71-33758-00 	70-35549-00 C2S 46933 16x 		70-31414-10 	81-90013-00 K PTFE 
								61-35425-20 87 Ø 1,2 mm MLS 3 						81-35556-00 N 36x50 A SL LD PTFE 
2,2	224DT	120-147 kW XF 2.2 D (163-200 PS)	04/11-04/15		02-39244-03 	08-39246-01 		61-35805-00 85,9 Ø 1,25 mm MLS 1 		15-38554-01 	12-38539-01 	11-38553-01 	70-31414-10 	81-36557-00 K 42x62 A SL RD PTFE 
								61-35805-10 85,9 Ø 1,3 mm MLS 2 			70-38539-00 16x 			81-36556-00 K 90x110 A SL LD PTFE 
								61-35805-20 85,9 Ø 1,35 mm MLS 3 				71-42393-00 		81-34144-00 N 27x47 A SL RD FPM 
								61-35805-30 85,9 Ø 1,4 mm MLS 4 						
2,5	AJ6	147 kW (200 S-TYPE 2.5 PS)	04/02-10/07					61-10294-00 R C2S 4924 0,8 mm MLS 	14-13247-01 2x 	71-12599-00 I XR8 47907 2x 	12-13237-01 XR8 5231 (12x) 	71-12608-00 I C2S 8098 6x 	71-34338-00 C2S 43270 	81-34314-00 K C2S48116 47,62x63,5 AB SL RD ACM 
								61-10295-00 L C2S 4925 0,8 mm MLS 		71-17237-00 A L XR8 16232 		71-16679-00 I XR8 43536 6x 		81-34318-00 K XR8 5147 91x108 AB LD NBR 
										71-17238-00 A R XR8 5374 	70-13237-00 XR8 5231 24x 	71-34307-00 C2S 33620 2x 		

JAGUAR														
Ltr.														
2,5	AJ6	147 kW (200 PS) S-TYPE 2.5	04/02-10/07 M45255→											
								<b>61-10294-00 R</b> C2S 4924 0,8 mm MLS	<b>14-13247-01</b> 2x	<b>71-12599-00 I</b> XR8 47907	<b>12-13237-01</b> XR8 5231 (12x)	<b>71-12608-00 I</b> C2S 8098	<b>71-34338-00</b> C2S 43270	<b>81-34314-00 K</b> C2S48116 47,62x63,5 AB SL RD ACM
								 <b>61-10295-00 L</b> C2S 4925 0,8 mm MLS		<b>71-12601-00 A L</b> C2S 34512	 <b>71-16679-00 I</b> XR8 43536	<b>71-34307-00</b> C2S 33620		 <b>81-34318-00 K</b> XR8 5147 91x108 AB LD NBR
								 		 <b>71-12602-00 A R</b> XR8 51930	 <b>70-13237-00</b> XR8 5231			
2,7	AJD	152 kW (207 PS) S-TYPE 2.7 XF 2.7 D XJ 2.7 D	06/04-04/15		<b>02-10043-01</b> 	<b>08-10192-01</b> 		<b>61-34875-10</b> C2S 51265 82,5 Ø 1,17 mm MLS	<b>14-32344-01</b> 2x	<b>71-38558-00</b> C22 19938	<b>12-38546-01</b> C2S 30281	<b>71-34888-00</b> C2S 30281	<b>71-12591-00</b> JDE 1098	<b>81-34316-00 K</b> C2C 11491 35x50 A SL RD PTFE ACM
								<b>61-34875-20</b> C2S 51266 82,5 Ø 1,22 mm MLS			 <b>70-38546-00</b> JD6 1439		 <b>71-38527-00</b> C2S 47774	 <b>81-90050-00 K</b> C2S 30238
								<b>61-34875-30</b> C2S 51267 82,5 Ø 1,27 mm MLS					 <b>81-38536-00 N</b> JD6 1567 26x45 A SL WD FPM	
								<b>61-34875-40</b> C2S 51268 82,5 Ø 1,32 mm MLS					 	
3,0	AJV6D 306DT	155-221 kW (211-300 PS) F-PACE 3.0 XF 3.0 D XJ 3.0 D	03/09		<b>02-10195-01</b> 	<b>08-12871-01</b> 		<b>61-36610-00</b> C2P 17981 85 Ø 1,17 mm MLS	<b>14-32344-01</b> 2x	<b>71-38558-00</b> C22 19938	<b>12-38546-01</b> C2S 30281	<b>71-34888-00</b> C2S 30281	<b>71-12591-00</b> JDE 1098	<b>81-34316-00 K</b> C2C 11491 35x50 A SL RD PTFE ACM
								<b>61-36610-10</b> C2P 17982 85 Ø 1,22 mm MLS			 <b>70-38546-00</b> JD6 1439		 <b>71-38527-00</b> C2S 47774	 <b>81-90050-00 K</b> C2S 30238
								<b>61-36610-20</b> C2P 17983 85 Ø 1,27 mm MLS					 <b>81-38536-00 N</b> JD6 1567 26x45 A SL WD FPM	
								<b>61-36610-30</b> C2P 17984 85 Ø 1,32 mm MLS					 	

JAGUAR





















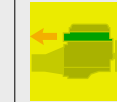







Ltr.	Part	Engine	Model	Date	Image 1	Image 2	Image 3	Image 4	Image 5	Image 6	Image 7	Image 8	Image 9	Image 10	Image 11		
3,0	AJ20D6	221 kW (300 PS)	F-PACE 3.0	10/20													
									<p><b>61-11241-00</b> JDE 41160 84 Ø 0,9 mm MLS </p> <p><b>61-11241-10</b> JDE 41161 84 Ø 1 mm MLS </p> <p><b>61-11241-20</b> JDE 41162 84 Ø 1,1 mm MLS </p> <p><b>61-11241-30</b> JDE 41163 84 Ø 1,2 mm MLS </p> <p><b>61-11241-40</b> JDE 41164 84 Ø 1,3 mm MLS </p>	<p><b>14-21242-01</b> JDE 40769 (14x)</p>	<p><b>71-21240-00</b> JDE 40791</p>	<p><b>12-13246-02</b> JDE 37047 (24x)</p> <p><b>70-13246-00</b> JDE 37047</p>	<p><b>71-21239-00</b> </p> <p>JDE 41128</p>	12x	<p><b>70-31414-10</b></p>	<p><b>81-10672-00</b> </p> <p>AJ8 14077 PTFE</p> <p><b>81-10396-00</b> </p> <p>AJ8 14076 92x109 LD Gummi</p>	
3,0	306PS	250-294 kW (340-400 PS)	F-PACE 3.0 F-TYPE 3.0 XE 3.0 S XF 2.0 XF 3.0 XJ 3.0	03/12					<p><b>61-10739-00 R</b> AJ8 13950 85,4 Ø 0,6 mm MLS</p> <p><b>61-10740-00 L</b> AJ8 13951 85,4 Ø 0,6 mm MLS</p>		<p><b>71-20293-00 R</b> AJ8 13020</p> <p><b>71-20294-00 L</b> AJ8 13023</p>	<p><b>12-19295-02</b> AJ8 13623 (24x)</p> <p><b>70-19295-00</b> AJ8 13623</p>	24x	<p><b>71-17234-00</b> </p> <p>CZZ 17249</p> <p><b>71-17231-00</b> </p> <p>AJ8 14038</p> <p><b>71-17233-00</b> </p> <p>AJ8 14039</p>	2x	<p><b>70-31414-10</b></p>	<p><b>81-10518-00</b> </p> <p>AJ8 11449 PTFE</p> <p><b>81-10654-00</b> </p> <p>CZZ 27888 FPM</p>
3,6	AJ8	190 kW (258 PS)	XJ 3.6	05/03-03/09					<p><b>61-10107-00 R</b> 1W93-6051-AC 87,3 Ø 0,55 mm MLS</p> <p><b>61-10108-00 L</b> 1W93-6083-AC 87,3 Ø 0,55 mm MLS</p>		<p><b>71-10904-00 R</b> AJ8 12399</p> <p><b>71-10905-00 L</b> AJ8 12402</p>	<p><b>12-10908-01</b> NCE 2528 AC (16x)</p> <p><b>70-10908-00</b> NCE 2528 AC</p>	16x	<p><b>71-13222-00</b> </p> <p>AJ8 9062</p> <p><b>71-17508-00</b> </p> <p>AJ8 10024</p> <p><b>71-17512-00</b> </p> <p>AJ8 10025</p>	2x	<p><b>71-17511-00</b> AJ8 9207</p>	<p><b>81-10580-00</b> </p> <p>AJ8 3698 52x69 A SL RD PTFE</p> <p><b>81-10434-00</b> </p> <p>3W43-6701-AA 100x120 PTFE</p>

JAGUAR

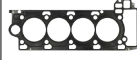
Ltr.	Part	Engine	Year	Image 1	Image 2	Image 3	Image 4	Image 5	Image 6	Image 7	Image 8	Image 9	Image 10	Image 11	Image 12	
4,2	AJ8FR	224 kW (305 PS) XJ 4.2	05/07-03/09													
								<p><b>61-10107-00 R</b> 1W93-6051-AC 87,3 Ø 0,55 mm MLS</p>		<p><b>71-10904-00 R</b> AJ8 12399</p>	<p><b>12-10908-01</b> NCE 2528 AC (16X)</p>	2x	<p><b>71-13222-00 L</b> → AJ8 9062</p>	2x	<p><b>71-17511-00</b> AJ8 9207</p>	<p><b>81-10580-00 K</b> → AJ8 3698 52x69 A SL RD PTFE</p>
								<p><b>61-10108-00 L</b> 1W93-6083-AC 87,3 Ø 0,55 mm MLS</p>		<p><b>71-10905-00 L</b> AJ8 12402</p>	<p><b>70-10908-00</b> NCE 2528 AC</p>	32x	<p><b>71-17508-00</b> → AJ8 10024</p>	<p><b>71-17512-00</b> → AJ8 10025</p>	<p><b>81-10434-00 K</b> → 3W43-6701-AA 100x120 PTFE</p>	
4,2	AJ8FT	219-291 kW XJ 4.2 (298-396 PS) XK 4.2 XKR 4.2 XK8 4.2	03/03-07/14					<p><b>61-10107-00 R</b> 1W93-6051-AC 87,3 Ø 0,55 mm MLS</p>	<p><b>14-10987-01</b> AJ8 9986 (20X)</p>	<p><b>71-10904-00 R</b> AJ8 12399</p>	<p><b>12-10908-01</b> NCE 2528 AC (16X)</p>	2x	<p><b>71-13222-00 L</b> → AJ8 9062</p>	2x	<p><b>71-17511-00</b> AJ8 9207</p>	<p><b>81-10580-00 K</b> → AJ8 3698 52x69 A SL RD PTFE</p>
								<p><b>61-10108-00 L</b> 1W93-6083-AC 87,3 Ø 0,55 mm MLS</p>		<p><b>71-10905-00 L</b> AJ8 12402</p>	<p><b>70-10908-00</b> NCE 2528 AC</p>	32x	<p><b>71-17508-00</b> → AJ8 10024</p>	<p><b>71-17512-00</b> → AJ8 10025</p>	<p><b>81-10434-00 K</b> → 3W43-6701-AA 100x120 PTFE</p>	
4,2	AJ8FT	291-298 kW S-TYPE 4.2 (396-405 PS)	11/01-12/08					<p><b>61-10107-00 R</b> 1W93-6051-AC 87,3 Ø 0,55 mm MLS → 0008311710 →</p>	<p><b>14-10987-01</b> AJ8 9986 (20X)</p>	<p><b>71-10904-00 R</b> AJ8 12399</p>	<p><b>12-10908-01</b> NCE 2528 AC (16X)</p>	2x	<p><b>71-13222-00 L</b> → AJ8 9062</p>	2x	<p><b>71-17511-00</b> AJ8 9207</p>	<p><b>81-10580-00 K</b> → AJ8 3698 52x69 A SL RD PTFE</p>
								<p><b>61-10108-00 L</b> 1W93-6083-AC 87,3 Ø 0,55 mm MLS → 0008311710 →</p>		<p><b>71-10905-00 L</b> AJ8 12402</p>	<p><b>70-10908-00</b> NCE 2528 AC</p>	32x	<p><b>71-17508-00</b> → AJ8 10024</p>	<p><b>71-17512-00</b> → AJ8 10025</p>	<p><b>81-10434-00 K</b> → 3W43-6701-AA 100x120 PTFE</p>	
								<p><b>61-10763-00 L</b> NCC2541BC 87 Ø 1,5 mm</p>								
								<p><b>61-10764-00 R</b> NCC2540BC 87 Ø 1,5 mm</p>								



JAGUAR

Ltr.														
5,0	AJ133G2 508PS	331-423 kW (450-575 PS) F-PACE 5.0 F-TYPE 5.0 XF 5.0 XJ 5.0 XK 5.0	01/09					<p><b>61-10884-00 R</b> AJ813952 93,3 Ø 0,6 mm MLS</p>  <p><b>61-10971-00 L</b> AJ813953 93,3 Ø 0,6 mm MLS</p> 		<p><b>15-19435-01 R</b> C2D3524 +C2D3527 (4X)</p> <p><b>15-19436-01 L</b> C2D3525 +C2D3526 (4X)</p>	<p><b>12-19295-01</b> AJ8 13623 (32X)</p>  <p><b>70-19295-00</b> AJ8 13623</p> <p>32x</p> 	<p><b>71-19463-00</b>  AJ8 11576</p>  <p><b>71-19464-00</b>  AJ8 11590</p> 	<b>70-31414-10</b> 	
5,0	508PN	283-287 kW (385-390 PS) XF 5.0 XJ 5.0 XK 5.0	01/09					<p><b>61-10884-00 R</b> AJ813952 93,3 Ø 0,6 mm MLS</p>  <p><b>61-10971-00 L</b> AJ813953 93,3 Ø 0,6 mm MLS</p> 		<p><b>15-19435-01 R</b> C2D3524 +C2D3527 (4X)</p> <p><b>15-19436-01 L</b> C2D3525 +C2D3526 (4X)</p>	<p><b>12-19295-01</b> AJ8 13623 (32X)</p>  <p><b>70-19295-00</b> AJ8 13623</p> <p>32x</p> 	<p><b>71-19434-00</b>  AJ8 11713</p> 	<b>70-31414-10</b> 	

# Haftungsausschluss (für Katalog)

**Alle Angaben in unserem Katalog** wurden von uns sorgfältig geprüft, sind jedoch unverbindlich. Ersatzansprüche wegen Katalogangaben werden von uns nicht anerkannt. Der Käufer ist selbst verpflichtet, zu prüfen, ob unsere Teile für seine Zwecke geeignet sind. In allen Zweifelsfällen sollte Rücksprache mit unserem technischen Kundendienst erfolgen **Tel. +49 731 7046 999**.

**Technische Weiterentwicklungen** oder Änderungen bleiben vorbehalten, soweit damit keine Nachteile für den Kunden verbunden sind.

**Angaben, Namens- und Markenzeichen**, Beschreibungen, Nummern von Fahrzeugnummern und Herstellerzeichen, Original-Ersatzteilnummern der Fahrzeug- und Motorenhersteller u. a. sind ausschließlich für interne Zwecke gedacht. Solche Kennzeichnungen dürfen Fahrzeugbesitzern gegenüber nicht verwendet werden.

**Wir weisen ausdrücklich darauf hin**, dass alle von uns gelieferten Teile von geschultem Fachpersonal einzubauen sind. Reinz haftet für Fehler in diesem Katalog nur, wenn diese für den Kunden nicht offenbar erkennbar sind sowie nur bei Vorsatz und grober Fahrlässigkeit von Reinz, eines Vertreters oder eines Erfüllungsgehilfen. Dieser Haftungsausschluss gilt nicht im Rahmen

des Anwendungsbereichs des Produkthaftungsgesetzes und nicht bei Verletzung von Körper, Leben und Gesundheit, sowie bei der Verletzung von sog. Kardinalpflichten. Darüber hinaus ist unsere Haftung für Schäden, insbesondere für Personen-, Sach- oder Vermögensschäden, die unmittelbar oder mittelbar im Zusammenhang mit der Nutzung dieses Kataloges auftreten, sowie für nicht voraussehbare Schäden ausgeschlossen.

**Reinz ist Inhaber aller Schutzrechte** an den in diesem Katalog gespeicherten Daten. Kopie, Nachdruck, ganze oder teilweise Übernahme der Inhalte und Vervielfältigung, auch auszugsweise, ist nur mit unserer vorheriger schriftlicher Zustimmung sowie mit unserem Urheberrechtsvermerk zulässig.

Für Bestellungen, welche ab dem Erscheinungsdatum eines neuen Katalogs getätigt werden, sind alleine die Angaben des neuen Katalogs maßgeblich. Auf Angaben im Vorkatalog kann bei Neubestellungen nicht mehr zurückgegriffen werden.

**Sofern Sie noch Fragen haben, bitten wir Sie, sich mit uns in Verbindung zu setzen.**

[VictorReinz.com/AGB](http://VictorReinz.com/AGB)

# Exclusion of Liability (for catalog)

**All details in our catalog** have been thoroughly checked by us but are however not binding. Right to damages on account of catalog details will not be recognized. The purchaser is obliged to check if our parts are suitable for their use. In all doubtful cases, the purchaser should consult our technical customer service under **+49 731 7046 999**.

**We reserve the right** to further technical developments or changes as long as no disadvantage for the customer results.

**Details, name and trademarks**, descriptions, numbers from vehicle numbers and manufacturer symbols, original vehicle replacement part numbers and engine manufacturer etc. are solely for internal use. Such labels must not be used with vehicle owners.

**We specifically point out** that all parts supplied by us must be assembled by trained specialists.

**Reinz is liable for mistakes** in this catalog only when they are not clearly recognizable for the customer, as well as by intent or gross negligence on the part of Reinz, its representative or vicarious agent. This exclusion of liability does not apply within the framework of the field of

application of the product liability laws and not by bodily harm, life and health, as well as by violation of cardinal duties. In addition, our liability for damages, especially personal, property or financial damages that occur directly or indirectly as a result of the use of this catalog, as well as non-foreseeable damages are excluded.

**Reinz is the owner of all patent rights** on the data stored in this catalog. Copies, reprints, whole or partial takeover of the contents and duplication even in excerpts are only permissible with our prior written approval, as well as with our copyright note.

**For orders placed after the publication date** of a new catalog, only the details in the new catalog are binding and no fall back to details in the previous catalog is possible.

**In case you have further questions, do not hesitate to contact us.**

[VictorReinz.com/AGB](http://VictorReinz.com/AGB)

**VictorReinz.com**

**reinz.info@dana.com**

**Technical Hotline +49 (0)731 7046-9 99**

**REINZ-Dichtungs-GmbH**

Reinzstrasse 3-7  
89233 Neu-Ulm  
Germany  
+49 (0)731 7046-0

***VICTOR REINZ***<sup>®</sup>

---

