

VICTOR REINZ®

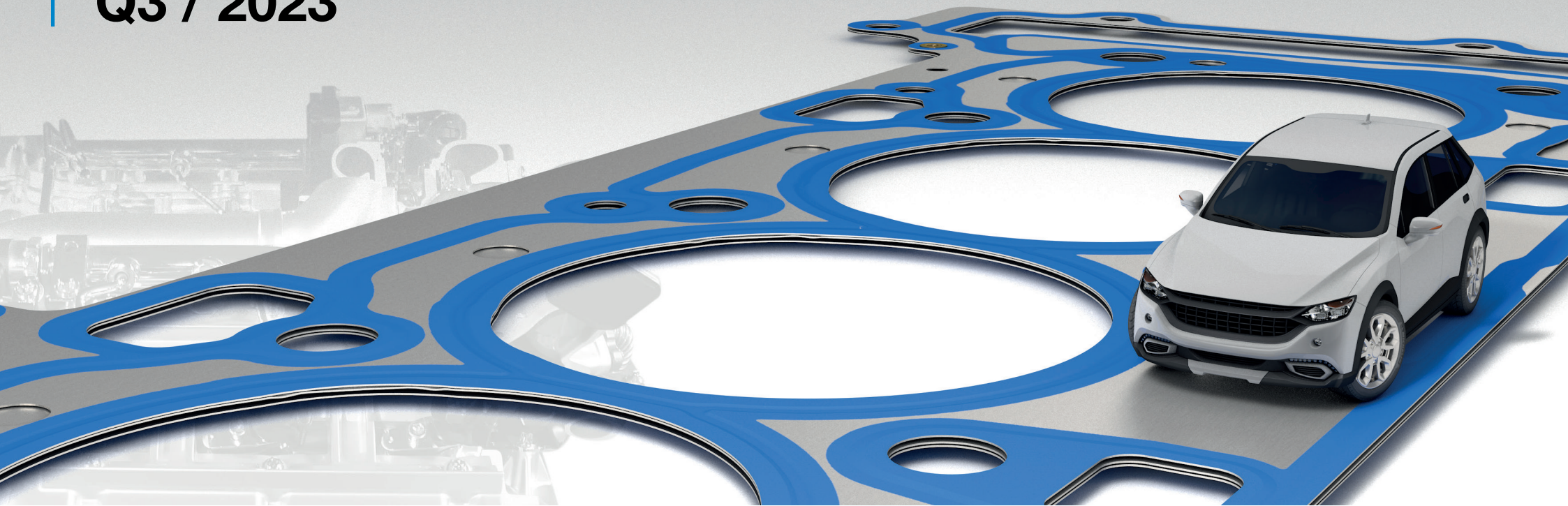

KIA
Q3 / 2023



VictorReinz.com/online-catalog

Victor Reinz®

at a Glance



Online Catalog

VictorReinz.com/online-catalog



Newsletter

VictorReinz.com/EN/News/Newsletter.aspx?region



Youtube

www.youtube.com/user/VictorReinzSealingEN



Catalog News

VictorReinz.com/news



Technical Service Information

VictorReinz.com/tsi



Facebook

www.facebook.com/VictorReinzParts



Just seal it!

VictorReinz.com/jsi



Technical Datasheet

VictorReinz.com/jsi-datasheet



LinkedIn

www.linkedin.com/showcase/victor-reinz-emea



Safety Datasheet

VictorReinz.com/jsi-datasheet



Homepage

VictorReinz.com

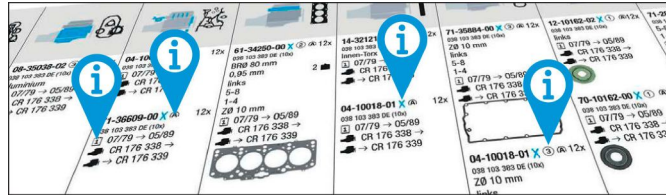

VictorReinz.com/catalog-info

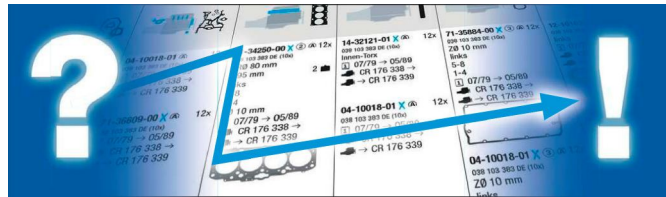

VictorReinz.com/catalog-how-to-use

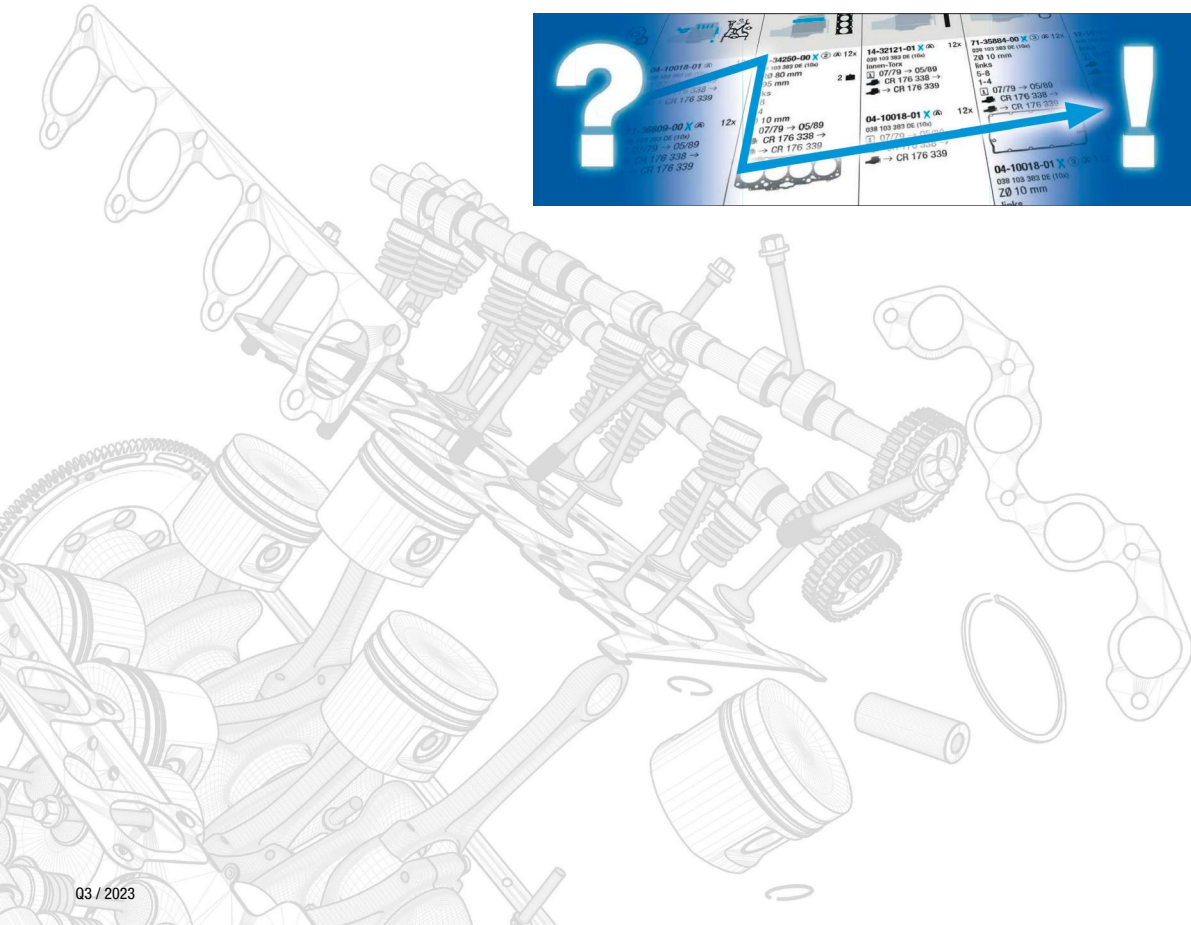

KIA



A

A3E 9

A5D 18

B

B1 7

B3 10

B3LA 5

B4ZE 20

B5 19

B6 20

BFD 19

D

D3FA 7-8

D4BH 51, 53

D4CB 54-55

D4EA 40-44

D4EA-F 44

D4FA 19-20

D4FB 21-24

D4FB-L 21

D4FC 11-14

D4FD 36-37

D4FE 24

D4HA 44-45

D4HB 50

D4HC 51

F

FE (16V) 45

G

G3LA 5-6

G3LC 6

G4CP 45

G4ED 24-25

G4EE 14

G4FA 15-16

G4FC 25-33

G4FD 33-34

G4FG 28, 34

G4FJ 34-35

G4GC 46-47

G4HE 7



G4HG 8

G4JP 47

G4JS 52

G4KD 47-48

G4KE 52-53

G4LA 9-10

G4LC 17

G4LD 18

G4LE 35-36

G4NA 48-49

G4NB 38

G4NC 49

G4ND 49

G4NH 49

G6BA 56

G6CU 60

G6DB 59

G6EA 57

J

J2 57

J3 58

J3(CRD) 58-59

K

K5 55

KRV6 55

O

OK24N 38

OK26Y 38

R

















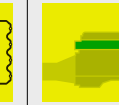
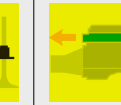
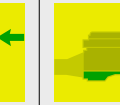





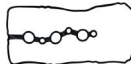











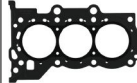
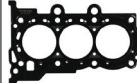

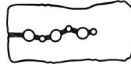













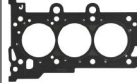

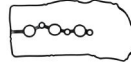











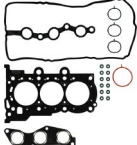
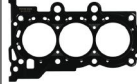

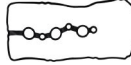

R2 51

RF 50





















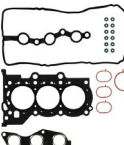
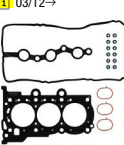



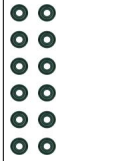











T

T8 39-40























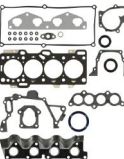

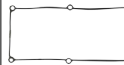
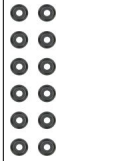











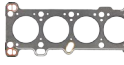





















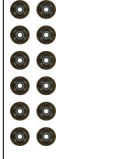

TB 38

KIA															
Ltr.															
1,0	B3LA	49-57 kW (67-78 PS)	PICANTO II LPG PICANTO III RAY	11/11					61-10157-00 22311-04020 72 Ø MLS 	14-12060-01 22321-04010 (8X) 	71-11591-00 22441-04050 	12-54071-03 22224-2B001 (12X)  70-54071-00 22224-2B001 12x 	71-18486-00  28411-04600  71-11590-00  28521-04000 	70-31414-10 	81-10472-00  21421-03001 34x48 A SL RD FPM  81-54164-00  21443-03010 72x98 A SL LD FPM 
1,0	B3LA	60 kW (82 PS)	PICANTO Bi-Fuel	05/11-10/14					61-10156-00 22311-04000 72 Ø MLS  ⇒ 02/12  61-10157-00 22311-04020 72 Ø MLS 	14-12060-01 22321-04010 (8X) 	71-11591-00 22441-04050 	12-54071-03 22224-2B001 (12X)  70-54071-00 22224-2B001 12x 	71-18486-00  28411-04600  71-11590-00  28521-04000 	70-31414-10 	81-10472-00  21421-03001 34x48 A SL RD FPM  81-54164-00  21443-03010 72x98 A SL LD FPM 
1,0	G3LA	48-56 kW (65-76 PS)	PICANTO III PICANTO III LPG PICANTO Mpi	03/17	01-11304-01 20910-04P06 	02-11304-01 20920-04P06 			61-11304-00 22311-04800 73 Ø MLS 	14-12060-01 22321-04010 (8X) 	71-18481-00 22441-04090 	12-54071-03 22224-2B001 (12X)  70-54071-00 22224-2B001 12x 	71-18482-00  28313-04900  71-18483-00  28535-04G00 	70-31414-10 	81-10472-00  21421-03001 34x48 A SL RD FPM  81-54164-00  21443-03010 72x98 A SL LD FPM 
1,0	G3LA	49 kW (67 PS)	PICANTO II	05/11-03/17	01-10157-03 20910-04P01 	02-10157-03 20920-04P01 			61-10157-00 22311-04020 72 Ø MLS 	14-12060-01 22321-04010 (8X) 	71-11591-00 22441-04050 	12-54071-03 22224-2B001 (12X)  70-54071-00 22224-2B001 12x 	71-15700-00  28411-03670  71-11590-00  28521-04000 	70-31414-10 	81-10472-00  21421-03001 34x48 A SL RD FPM  81-54164-00  21443-03010 72x98 A SL LD FPM 





KIA

<p>Ltr.  1.0 G3LA</p>	<p>51 kW (69 PS)</p>	<p>PICANTO II</p>	<p>05/11-03/17</p>	<p></p>	<p></p>	<p></p>	<p></p>	<p></p>	<p></p>	<p></p>	<p></p>	<p>01-10156-01 20910-04A01 1 ⇒ 02/12</p>  <p>01-10157-01 20910-04A01A 1 ⇒ 03/12 →</p> 	<p>02-10156-01 20920-04A01 1 ⇒ 02/12</p>  <p>02-10157-01 20920-04A01A 1 ⇒ 03/12 →</p> 				<p>61-10156-00 22311-04000 72 Ø MLS 1 ⇒ 02/12</p>  <p>61-10157-00 22311-04020 72 Ø MLS 1 ⇒ 03/12 →</p> 	<p>14-12060-01 22321-04010 (8X)</p> 	<p>71-11591-00 22441-04050</p> 	<p>12-54071-03 22224-2B001 (12X)</p>  <p>70-54071-00 22224-2B001</p> 	<p>71-11522-00 1 ⇒ 3x 28411-04000</p>  <p>71-11590-00 1 ⇒ 28521-04000</p> 	<p>70-31414-10</p> 	<p>81-10472-00 K ⇔ 21421-03001 34x48 A SL RD FPM</p>  <p>81-54164-00 K ⇔ 21443-03010 72x98 A SL LD FPM</p> 
<p>1.0 G3LC</p>	<p>74 kW (100 PS)</p>	<p>PICANTO T-Gdi</p>	<p>03/17</p>					<p>61-11302-00 22311-04031 72,5 Ø MLS</p> 	<p>14-12060-01 22321-04010 (8X)</p> 	<p>71-18479-00 1 ⇒ 3x 28411-04500</p>  <p>71-18480-00 1 ⇒ 28521-04500</p> 	<p>70-31414-10</p> 	<p>01-11302-01 20910-04P03</p>	<p>02-11302-01 20920-04P03</p>				<p>61-11302-00 22311-04031 72,5 Ø MLS</p> 	<p>14-12060-01 22321-04010 (8X)</p> 	<p>71-18478-00 22441-04070</p> 	<p>12-54071-02 22224-2B001 (16x)</p>  <p>70-54071-00 22224-2B001</p> 	<p>71-18479-00 1 ⇒ 3x 28411-04500</p>  <p>71-18480-00 1 ⇒ 28521-04500</p> 	<p>70-31414-10</p> 	<p>81-10472-00 K ⇔ 21421-03001 34x48 A SL RD FPM</p>  <p>81-54164-00 K ⇔ 21443-03010 72x98 A SL LD FPM</p> 
<p>1.0 G3LC</p>	<p>74-88 kW (100-120 PS)</p>	<p>CEED T-GDi PRO CEED CRDi PRO CEED T-GDi RIO IV T-GDi STONIC T-GDi XCEED T-GDi</p>	<p>04/15</p>																				

KIA

<p>Ltr. </p>	<p></p>	<p></p>	<p></p>	<p></p>	<p></p>	<p></p>	<p></p>	<p></p>	<p></p>	<p></p>	<p></p>
<p>1,0 G4HE 45-46 kW (61-63 PS) PICANTO I PICANTO I LPG</p> <p>04/04-04/11 [NEW]</p>	<p>01-53895-01 20910-02H00 +21421-21030 +21411-02500 +22224-02500 (12x)</p> 	<p>02-53895-01</p> 			<p>61-53895-00 22311-02760 MLS</p> 	<p>14-12197-01 22320-02500 (10x)</p>	<p>71-53601-00 22441-02400</p> 	<p>12-53929-01 22224-02500 (12x)</p>  <p>70-53929-00 22224-02500 12x</p> 	<p>71-53421-00   28411-02500</p>  <p>71-53599-00  28521-02700</p> 	<p>70-31414-10</p> 	<p>81-53232-00  21421-21030 30x46 A SL RD NBR</p>  <p>81-53424-00  21443-02501 60x75 A SL LD NBR</p>  <p>81-53246-00 N 22144-3B001 35x50 A SL RD FPM</p> 
<p>1,1 B1 38 kW (52 PS) PRIDE</p> <p>01/91-10/00</p>					<p>61-52420-00 73 Ø</p> 		<p>71-52416-00</p> 	<p>12-54023-01</p>  <p>70-54023-00 8x</p> 	<p>71-52673-00   71-52674-00 </p>  	<p>71-52417-00</p> 	<p>81-53228-00  KRY01 12 602 30x44 A SL RD NBR</p>  <p>81-53404-00  OK201 11 312 83x100 A SL LD MVQ</p>  <p>81-53228-00 N KRY01 12 602 30x44 A SL RD NBR</p> 
<p>1,1 D3FA 55 kW (75 PS) PICANTO I CRDI</p> <p>10/05-04/11 [NEW]</p>			<p>04-10384-01 </p> 		<p>61-10018-00  22312-2A001 77 Ø 1,05 mm MLS</p> <p>61-10018-10 22311-2A001 77 Ø 1,1 mm MLS 1 </p> <p>61-10018-20  22313-2A001 77 Ø 1,15 mm MLS 2 </p> 	<p>14-10373-02</p> 	<p>15-10018-01  06/07 →</p> 	<p>12-10143-02 22224-2A100 (12x)</p>  <p>70-10143-00 12x</p> 	<p>71-12931-00  28355-2A000</p>  <p>71-10142-00  28521-2A000</p> 	<p>70-31414-10</p> 	<p>81-10382-00  21361-2A200 41x53 A SL RD FPM</p>  <p>81-53343-00  21443-2A200 91x111 A SL LD MVQ</p> 

KIA

Ltr.  55 kW (75 PS)  09/11-12/17
 1,1   **[NEW]**



01-10018-03
20910-2A000
 ⇒ 07/14



01-10021-01
 ⇒ 07/14



01-10018-04
20910-2A000A
 08/14 →

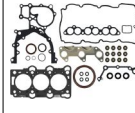

01-10023-01
 08/14 →

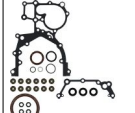

02-10018-03
20920-2A000

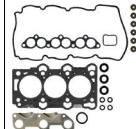

02-10041-01



04-10384-01 



61-10018-00 
22312-2A001
77 Ø
1,05 mm
MLS

61-10018-10
22311-2A001
77 Ø
1,1 mm
MLS

61-10018-20 
22313-2A001
77 Ø
1,15 mm
MLS

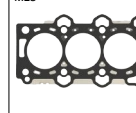

14-10373-02
 ⇒ 10/13

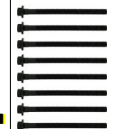

14-11540-02
22321-2A600 (8X)
 11/13 →

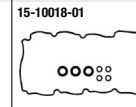

15-10018-01



12-10143-02
22224-2A100 (12x)

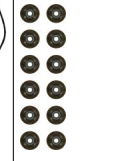

70-10143-00 12x
22224-2A100

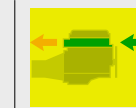

71-12931-00 
28355-2A000



71-10142-00 
28521-2A000

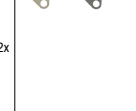

70-31414-10

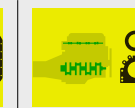

81-10382-00 
21361-2A200
41x53
A SL RD FPM



81-53343-00 
21443-2A200
91x111
A SL LD MVQ



1,1  48 kW (65 PS)  04/04-09/11
 1,1   **[NEW]**

01-53895-01
20910-02H00
+21421-21030
+21411-02500
+22224-02500 (12x)



02-53895-01



61-53895-00
22311-02760
MLS

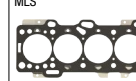

14-12197-01
22320-02500 (10X)

71-53601-00
22441-02400

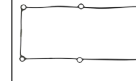

12-52772-02
22224-02500 (12x)

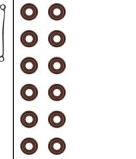

71-53421-00 
28411-02500



71-53599-00 
28521-02700



70-31414-10



81-53232-00 
21421-21030
30x46
A SL RD NBR

















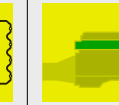
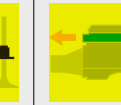
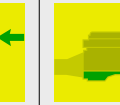

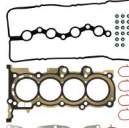
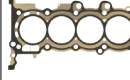
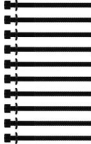
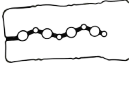













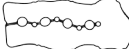















81-53424-00 
21443-02501
60x75
A SL LD NBR























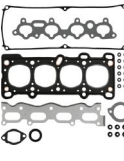
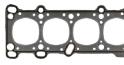















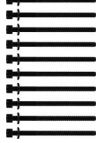











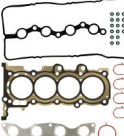

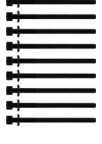
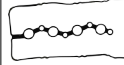



81-53246-00 
22144-3B001
35x50
A SL RD FPM

















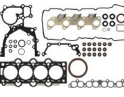

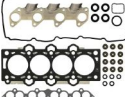















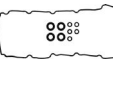





KIA														
1,2	G4LA	51-65 kW (69-88 PS)	PICANTO II RIO III	09/11-12/17	01-10139-01 20910-03C00 	02-10139-01 20920-03C00 		61-10139-00 22311-03211 72 Ø 0,5 mm MLS 	14-12061-01 22320-03000 (10x) 	71-54161-00 22441-03050 	12-54071-02 22224-2B001 (16x)  70-54071-00 22224-2B001 	71-11522-00  4x 28411-04000 71-54163-00  28521-03500 70-54071-00  16x 22224-2B001 	70-31414-10 	81-53243-00  K 0FE01 10 602 34x48 A SL RD MVQ 81-54164-00  K 21443-03010 72x98 A SL LD FPM 
1,2	G4LA	62 kW (84 PS)	PICANTO III STONIC	03/17	01-11330-01 20910-03P02 	02-11330-01 20920-03P02 		61-11330-00 22311-03610 72,5 Ø MLS 	14-12061-01 22320-03000 (10x) 	71-20235-00 22441-03080 	12-54071-02 22224-2B001 (16x)  70-54071-00 22224-2B001 	71-15700-00  4x 28411-03670 71-16664-00  28521-03610 70-54071-00  16x 22224-2B001 	70-31414-10 	81-54164-00  K 21443-03010 72x98 A SL LD FPM 
1,3	A3E	55-60 kW (75-82 PS)	RIO I	08/00-02/05	01-53380-01 0K30C 10 270 	02-53380-01 		61-53380-00 0K30C 10 271A 76,5 Ø MLS 	14-55077-01 0K30C 10 135A (10x) 	71-53472-00 0K30C 10 235A 	12-53473-01 0K30C 10 155B (8x)  71-53471-00 28521-2X600 	71-53469-00  4x 0K30C 13 111C 71-53471-00  28521-2X600 	10-53474-01 21522-2X00 +21521-2X00 70-31414-10 	81-53253-00  K 0B3C7 10 602B 36,5x50,5 A SL RD MVQ 81-53404-00  K 0K201 11 312 83x100 A SL LD MVQ 

KIA













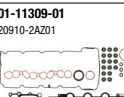
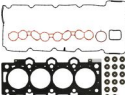
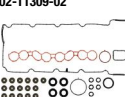
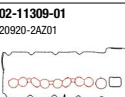









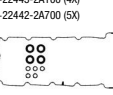



<p>Ltr.  1</p>											
<p>1,3 B3 55 kW (75 PS) AVELLA 11/95-12/01</p>	<p>01-52677-01 </p>	<p>02-52677-01 </p>			<p>61-52677-00 72,9 Ø </p>		<p>71-52686-00 </p>	<p>12-52829-01 OKL02 10 155 (16x) </p>	<p>71-52764-00   71-53053-00  </p>	<p>10-52691-01  70-31414-10 </p>	<p>81-53253-00  083C7 10 602B 36,5x50,5 A SL RD MVQ  81-53404-00  0K201 11 312 83x100 A SL LD MVQ  81-53228-00 N KKY01 12 602 30x44 A SL RD NBR </p>
<p>1,3 G4LA 62 kW (84 PS) RIO IV 01/17</p>	<p>01-11330-01 20910-03P02 </p>	<p>02-11330-01 20920-03P02 </p>			<p>61-11330-00 22311-03610 72,5 Ø MLS </p>	<p>14-12061-01 22320-03000 (10x) </p>	<p>71-20235-00 22441-03080 </p>	<p>12-54071-02 22224-2B001 (16x)  70-54071-00 22224-2B001 </p>	<p>71-15700-00  28411-03670  71-16664-00  28521-03610 </p>	<p>70-31414-10 </p>	<p>81-54164-00  21443-03010 72x98 A SL LD FPM </p>
<p>1,3 G4LA 63-65 kW (86-88 PS) RIO III RIO III LPG 06/11-12/17</p>	<p>01-10139-01 20910-03C00 </p>	<p>02-10139-01 20920-03C00 </p>			<p>61-10139-00 22311-03211 72 Ø 0,5 mm MLS </p>	<p>14-12061-01 22320-03000 (10x) </p>	<p>71-54161-00 22441-03050 </p>	<p>12-54071-02 22224-2B001 (16x)  70-54071-00 22224-2B001 </p>	<p>71-11522-00  28411-04000  71-54163-00  28521-03500 </p>	<p>70-31414-10 </p>	<p>81-53243-00  0FE01 10 602 34x48 A SL RD MVQ  81-54164-00  21443-03010 72x98 A SL LD FPM </p>

KIA













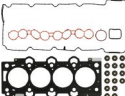
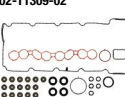









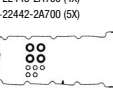



Ltr.  1,4 D4FC 55-57 kW (75-78 PS)  VENGA CRDI 02/10 

 01-10241-01 20910-2AK10A  01-10241-02 	 02-10241-01 20920-2AK10  02-10241-02 		 04-10360-01  07/14→ 	 61-10024-00  22312-2A102 77 Ø 1,05 mm MLS 61-10024-10 22311-2A102 77 Ø 1,1 mm MLS 61-10024-20  22313-2A102 77 Ø 1,15 mm MLS 	 14-10373-01 22321-2A110 (10x)  ⇒ 09/13  14-11540-01 22321-2A600 (10x)  ⇒ 10/13→ 	 15-10019-01 22441-2A102 +22443-2A100 (4X) +22441-2A021 (5X) 	 12-10143-01 22224-2A100 (16x)  70-10143-00 22224-2A100 	 71-10154-00  28355-2A101  71-10149-00  28521-2A701 	 70-31414-10 	 81-10382-00  21361-2A200 41x53 A SL RD FPM  81-53343-00  21443-2A200 91x111 A SL LD MVQ 
--	---	---	---	---	---	--	--	--	---	---



1,4 D4FC 57-66 kW (78-90 PS) RIO IV CRDI 01/17



 01-11309-01 20910-2AZ01  01-11309-02 	 02-11309-01 20920-2AZ01  02-11309-02 	 04-10360-01  	 61-11309-00 22312-2A160 77 Ø 0,95 mm MLS 61-11309-10 22311-2A160 77 Ø 1 mm MLS 61-11309-20 22313-2A160 77 Ø 1,05 mm MLS 	 14-11540-01 22321-2A600 (10x) 	 15-11242-01 22441-2A600 +22443-2A100 (4X) +22442-2A700 (5X) 	 12-10143-01 22224-2A100 (16x)  70-10143-00 22224-2A100 	 71-15701-00  28312-2A780  71-17067-00  28521-2A702 	 70-31414-10 	 81-10382-00  21361-2A200 41x53 A SL RD FPM  81-53343-00  21443-2A200 91x111 A SL LD MVQ 
--	--	---	---	--	--	---	---	--	--

1,4 D4FC 66 kW (90 PS) CEED CRDI 04/15-07/18



 01-11309-01 20910-2AZ01  01-11309-02 	 02-11309-01 20920-2AZ01  02-11309-02 	 04-10360-01  05/15→ 	 61-11309-00 22312-2A160 77 Ø 0,95 mm MLS 61-11309-10 22311-2A160 77 Ø 1 mm MLS 61-11309-20 22313-2A160 77 Ø 1,05 mm MLS 	 14-11540-01 22321-2A600 (10x) 	 15-11242-01 22441-2A600 +22443-2A100 (4X) +22442-2A700 (5X) 	 12-10143-01 22224-2A100 (16x)  70-10143-00 22224-2A100 	 71-15701-00  28312-2A780  71-17067-00  28521-2A702 	 70-31414-10 	 81-10382-00  21361-2A200 41x53 A SL RD FPM  81-53343-00  21443-2A200 91x111 A SL LD MVQ 
--	--	---	--	---	---	---	---	--	--



KIA

Ltr.  1,4 D4FC 66 kW (90 PS)  CEED CRDi PRO CEED CRDi  05/12-07/18  1

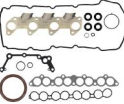
 **01-10019-01**
20910-2AU01
 ⇒ 08/14

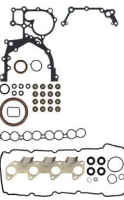

 **01-10019-02**
 ⇒ 08/14

 **01-10240-01**
20910-2AU01A
 ⇒ 09/14 →

 **01-10240-02**
 ⇒ 09/14 →

 **02-10019-01**
20920-2AU01

 **02-10019-02**

 **04-10360-01**
 05/15 →





 **61-10024-00** ✕
22312-2A102
77 Ø
1,05 mm
MLS



 **61-10024-10**
22311-2A102
77 Ø
1,1 mm
MLS 

 **61-10024-20** ✕
22313-2A102
77 Ø
1,15 mm
MLS 



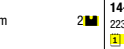

 **14-10373-01**
22321-2A110 (10x)
 ⇒ 09/13

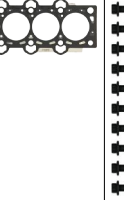

 **14-11540-01**
22321-2A600 (10x)
 10/13 →



 **15-10019-01**
22441-2A102
+22443-2A100 (4x)
+22441-2A021 (5x)



 **12-10143-01**
22224-2A100 (16x)

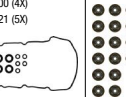

 **70-10143-00**
22224-2A100

 **71-10150-00** 

28312-2A800





71-10149-00 

28521-2A701





 **70-31414-10**



 **81-10382-00** 

21361-2A200
41x53
A SL RD FPM

































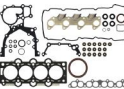
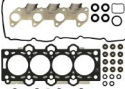

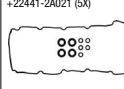











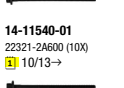

81-53343-00 

21443-2A200
91x111
A SL LD MVQ





KIA

Ltr.  1,4 D4FC 66 kW (90 PS) RIO III CRDi 09/11-12/17  1

										
<p>01-10241-01 20910-2AK10A  ⇒ 08/14</p>	<p>02-10241-01 20920-2AK10</p>		<p>04-10360-01  10/14→</p>	<p>61-10024-00  X 22312-2A102 77 Ø 1,05 mm MLS</p>	<p>14-10373-01 22321-2A110 (10x)  ⇒ 09/13</p>	<p>15-10019-01 22441-2A102 +22443-2A100 (4X) +22441-2A021 (5X)</p>	<p>12-10143-01 22224-2A100 (16x)</p>	<p>71-10154-00  X 28355-2A101</p>	<p>70-31414-10  X</p>	<p>81-10382-00  X 21361-2A200 41x53 A SL RD FPM</p>
				<p>61-10024-10 22311-2A102 77 Ø 1,1 mm MLS</p>						
<p>01-10241-02  ⇒ 08/14</p>	<p>02-10241-02</p>			<p>61-10024-20  X 22313-2A102 77 Ø 1,15 mm MLS</p>	<p>14-11540-01 22321-2A600 (10X)  10/13→</p>		<p>70-10143-00 22224-2A100</p>	<p>71-10149-00  X 28521-2A701</p>	<p>81-53343-00  X 21443-2A200 91x111 A SL LD MVQ</p>	
										
<p>01-10242-01 20910-2AK10B  09/14→</p>										
										
<p>01-10242-02  09/14→</p>										
										
										

KIA

Ltr.  1,4 D4FC 66 kW (90 PS)  VENGA CRDI  02/10

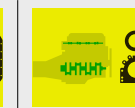
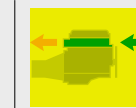

01-10241-01
20910-2AK10A
 10/10→

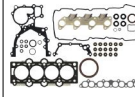

01-10241-02
10/10→



02-10241-01
20920-2AK10

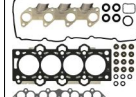

02-10241-02

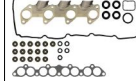

61-10024-00 
22312-2A102
77 Ø
1,05 mm
MLS

61-10024-10
22311-2A102
77 Ø
1,1 mm
MLS

61-10024-20 
22313-2A102
77 Ø
1,15 mm
MLS



14-10373-01
22321-2A110 (10x)
 ⇒ 09/13

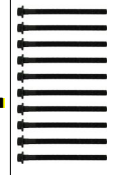

14-11540-01
22321-2A600 (10x)
 10/13→

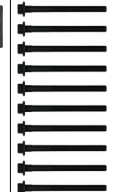

15-10019-01
22441-2A102
+22443-2A100 (4x)
+22441-2A021 (5x)

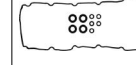

12-10143-01
22224-2A100 (16x)



70-10143-00
22224-2A100



71-10154-00 
28355-2A101



71-10149-00 
28521-2A701



70-31414-10



81-10382-00 
21361-2A200
41x53
A SL RD FPM



81-53343-00 
21443-2A200
91x111
A SL LD MVQ



1,4 G4EE 55-71 kW (75-97 PS)  PRIDE RIO II  03/05-12/11

01-53965-02
KSN61 10 270



61-53965-00
22311-26603
77 Ø



14-55096-01
22321-26000 (10x)

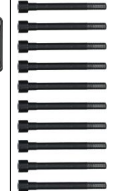

15-53967-02
22441-26020 (1x)
+22442-23500 (2x)
+22443-23001 (4x)



12-53678-01
22224-23500 (16x)



70-53678-00
22224-23500



71-53969-00 
28411-26011



71-53971-00 
28521-26600



70-31414-10



81-53972-00 
21421-22020
35x48
A SL RD FPM





















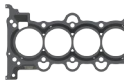

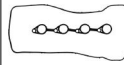

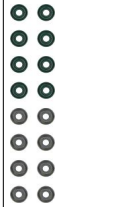



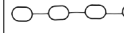











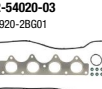
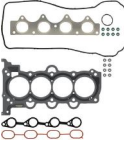

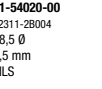



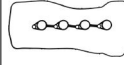

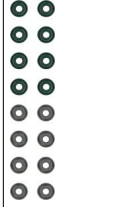



81-53306-00 
21443-22000
72x96
A SL LD MVQ



















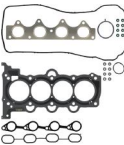







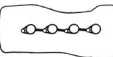





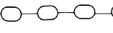











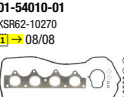







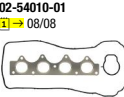

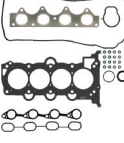

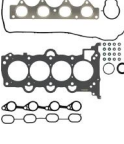



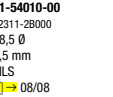



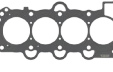

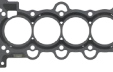

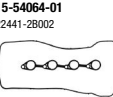



81-53246-00 **N**
22144-38001
35x50
A SL RD FPM

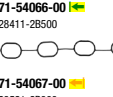

KIA

<p>Ltr. </p>	<p>1,4 G4FA 64-80 kW (87-109 PS)</p>	<p>CEED PRO CEED</p>	<p>01/09-12/12 </p>		<p>01-54020-01 20910-2B801</p> 		<p>02-54020-01 20920-2B801</p> 						<p>61-54020-00 22311-2B004 78,5 Ø 0,5 mm MLS</p> 				<p>15-54064-01 22441-2B002</p> 		<p>12-54071-01 22224-2B000 (8x) +22224-2B010 (8x)</p>  <p>70-54071-00 AS 8x 22224-2B001</p>  <p>70-54072-00 ES 8x 22224-2B011</p> 		<p>71-54066-00  28411-2B500</p>  <p>71-54067-00  28521-2B000</p> 		<p>70-31414-10</p> 		<p>81-54068-00  21421-2B030 26x37,5 A SL RD FPM</p>  <p>81-54069-10  21443-2B020 76x108 A SL LD FPM</p> 
<p>1,4 G4FA 66 kW (90 PS)</p>	<p>VENGA VENGA LPG</p>	<p>02/10</p>			<p>01-54020-03 20910-2B601</p> 		<p>02-54020-03 20920-2B601</p> 						<p>61-54020-00 22311-2B004 78,5 Ø 0,5 mm MLS</p> 				<p>15-54064-01 22441-2B002</p> 		<p>12-54071-01 22224-2B000 (8x) +22224-2B010 (8x)</p>  <p>70-54071-00 AS 8x 22224-2B001</p>  <p>70-54072-00 ES 8x 22224-2B011</p> 		<p>71-11604-00  28411-2B350</p>  <p>71-54067-00  28521-2B000</p> 		<p>70-31414-10</p> 		<p>81-54068-00  21421-2B030 26x37,5 A SL RD FPM</p>  <p>81-54069-10  21443-2B020 76x108 A SL LD FPM</p> 

KIA

















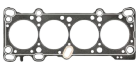

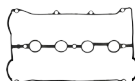













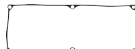
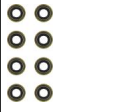



















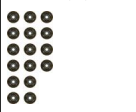

<p>Ltr.  1,4 G4FA 66-80 kW (90-109 PS)  CEED PRO CEED RIO III  06/11-07/18</p>	 01-54020-04 20910-2B600A 	 02-54020-04 20920-2B600 			 61-54020-00 22311-2B004 78,5 Ø 0,5 mm MLS 	 14-12196-01 22321-2B700 (10X) 	 15-54064-01 22441-2B002 	 12-54071-01 22224-2B000 (8x) +22224-2B010 (8x)  70-54071-00 AS 8x 22224-2B001  70-54072-00 ES 8x 22224-2B011 	 71-54066-00  28411-2B500  71-54067-00  28521-2B000 	 70-31414-10 	 81-54068-00  21421-2B030 26x37,5 A SL RD FPM  81-54069-10  21443-2B020 76x108 A SL LD FPM 
<p>1,4 G4FA 77-80 kW (105-109 PS)  CEED PRO CEED  12/06-12/12</p>	 01-54010-01 KSR62-10270  08/08  01-54015-01 KSR62-10270A  08/08 →  09/08  01-54020-01 20910-2B801  09/08 → 	 02-54010-01  08/08  02-54015-01  08/08 →  09/08  02-54020-01 20920-2B801  09/08 → 			 61-54010-00 22311-2B000 78,5 Ø 0,5 mm MLS  08/08  61-54015-00 22311-2B001 78,5 Ø 0,5 mm MLS  08/08 →  09/08  61-54020-00 22311-2B004 78,5 Ø 0,5 mm MLS  09/08 → 	 15-54064-01 22441-2B002 	 12-54071-01 22224-2B000 (8x) +22224-2B010 (8x)  70-54071-00 AS 8x 22224-2B001  70-54072-00 ES 8x 22224-2B011 	 71-54066-00  28411-2B500  71-54067-00  28521-2B000 	 70-31414-10 	 81-54068-00  21421-2B030 26x37,5 A SL RD FPM  81-54069-10  21443-2B020 76x108 A SL LD FPM 	

KIA															
1,4	G4LC	71-73 kW (97-99 PS)	RIO IV STONIC STONIC LPG	01/17	01-11306-01 20910-03P01 	02-11306-01 20920-03P01 			61-11306-00 22311-03451 74 Ø MLS 	14-12061-01 22320-03000 (10X) 	71-18484-00 22441-03140 	12-54071-02 22224-2B001 (16x) 	71-15700-00 28411-03670 71-16664-00 28521-03610 	70-31414-10 	81-10472-00 21421-03001 34x48 A SL RD FPM 81-54164-00 21443-03010 72x98 A SL LD FPM
1,4	G4LC	71-74 kW (97-100 PS)	CEED CEED LPG RIO IV	07/17	01-11310-01 20910-03Z00 	02-11310-01 20920-03Z00 			61-11310-00 22311-03500 73,5 Ø MLS 	14-12061-01 22320-03000 (10X) 	71-54161-00 22441-03050 	12-54071-02 22224-2B001 (16x) 	71-15700-00 28411-03670 71-16664-00 28521-03610 	70-31414-10 	81-10472-00 21421-03001 34x48 A SL RD FPM 81-54164-00 21443-03010 72x98 A SL LD FPM
1,4	G4LC	74 kW (101 PS)	CEED PRO CEED	04/15-07/18	01-11294-01 20910-03U02 	02-11294-01 20920-03U02 			61-11294-00 22311-03441 73,8 Ø MLS 	14-12061-01 22320-03000 (10X) 	71-54161-00 22441-03050 	12-54071-02 22224-2B001 (16x) 	71-15700-00 28411-03670 71-16664-00 28521-03610 	70-31414-10 	81-10472-00 21421-03001 34x48 A SL RD FPM 81-54164-00 21443-03010 72x98 A SL LD FPM
1,4	G4LC	74 kW (101 PS)	RIO IV	01/17	01-11306-01 20910-03P01 01-11310-01 20910-03Z00 	02-11306-01 20920-03P01 02-11310-01 20920-03Z00 			61-11306-00 22311-03451 74 Ø MLS 61-11310-00 22311-03500 73,5 Ø MLS 	14-12061-01 22320-03000 (10X) 	71-18484-00 22441-03140 71-54161-00 22441-03050 	12-54071-02 22224-2B001 (16x) 	71-15700-00 28411-03670 71-16664-00 28521-03610 	70-31414-10 	81-10472-00 21421-03001 34x48 A SL RD FPM 81-54164-00 21443-03010 72x98 A SL LD FPM











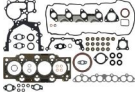
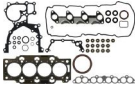

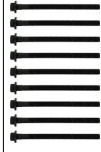











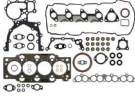
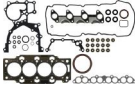
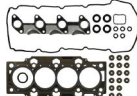

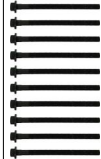









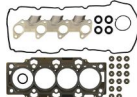
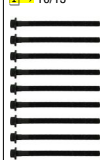
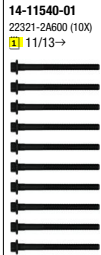
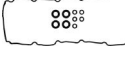

KIA

















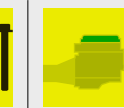

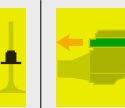
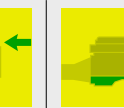

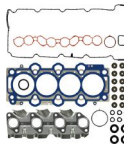
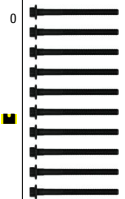
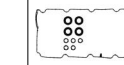
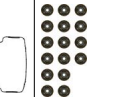







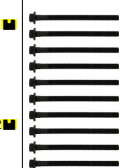

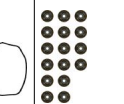







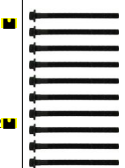

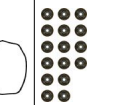





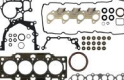
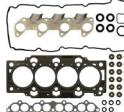
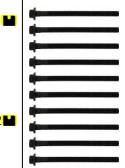

Ltr.	Motor	Power	Model	Year	01-11308-01	02-11308-01											
1,4	G4LD	103 kW (140 PS)	CEED T-GDi PRO CEED T-GDi SELTOS T-GDi XCEED T-GDi XCEED T-GDi	03/18	20910-03U05A	20920-03U05					61-11308-00 22311-03800 72,5 Ø MLS		71-18741-00 22441-03170	12-54071-02 22224-2B001 (16x)	71-18742-00 28411-04500 71-18742-00 28521-03410	70-31414-10	81-10472-00 K 21421-03001 34x48 A SL RD FPM 81-54164-00 K 21443-03010 72x98 A SL LD FPM
1,5	A5D	70 kW (95 PS)	RIO I	09/02-02/05							61-53390-00 OK30E 10 271A 76,5 Ø MLS		71-53488-00 OK30E 10 235 1 ⇒ 02/03	12-53489-01 OK30E 10 155 (16x)		10-53492-01 MB6F4 10 428 70-31414-10	81-53404-00 K OK201 11 312 83x100 A SL LD MVQ 81-53491-00 N 34x52 A SL RD MVQ
1,5	A5D	71 kW (97 PS)	RIO I	09/02-02/05							61-53390-00 OK30E 10 271A 76,5 Ø MLS		71-53488-00 OK30E 10 235 1 ⇒ 02/03	12-53489-01 OK30E 10 155 (16x)		10-53492-01 MB6F4 10 428 70-31414-10	81-53404-00 K OK201 11 312 83x100 A SL LD MVQ
1,5	A5D	72 kW (98 PS)	RIO I	08/00-02/05	01-53390-01 OK30E 10 270 1 ⇒ 07/02	02-53390-01 1 ⇒ 07/02					61-53390-00 OK30E 10 271A 76,5 Ø MLS		71-53488-00 OK30E 10 235 1 ⇒ 02/03	12-53489-01 OK30E 10 155 (16x)	71-53487-00 OK30E 13 111C 1 ⇒ 07/02 71-53486-00 OK30E 13 460C 1 ⇒ 07/02	10-53492-01 MB6F4 10 428 70-31414-10	81-53404-00 K OK201 11 312 83x100 A SL LD MVQ 81-53491-00 N 34x52 A SL RD MVQ

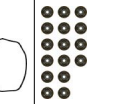
KIA

<p>Ltr.  1,5 BFD 65-66 kW (88-90 PS)  SEPHIA SHUMA SHUMA I  10/97-10/01</p>					<p>61-53315-00 OK2A3 10 271 79,5 Ø</p> 		<p>71-52886-00 0B6S7 10 235C</p> 	<p>70-54282-00 OKL02 10 155</p> 	<p>71-53401-00 </p>  <p>71-53402-00 </p> 		<p>81-53253-00 </p>  <p>81-53404-00 </p> 
<p>1,5 B5 59 kW (80 PS) SEPHIA 02/96-10/97</p>	<p>01-53890-01 OK20W 10 270B</p> 	<p>02-53890-01</p> 			<p>61-53890-00 0B61L 10 271A 1,2 mm</p> 		<p>71-53923-00 OK2A1 10 235A</p> 	<p>12-53924-01 MB630 10 155 (8x)</p>  <p>70-53924-00 MB630 10 155</p> 	<p>71-53926-00 </p>  <p>71-53927-00 </p> 	<p>10-53403-01 21521 2X000 +21522 2X000</p>  <p>70-31414-10</p> 	<p>81-53253-00 </p>  <p>81-53404-00 </p>  <p>81-53228-00 </p> 
<p>1,5 D4FA 54-75 kW (73-102 PS) CERATO I CERATO I CRDi 07/05-12/09 </p>				<p>04-10384-01 </p> 	<p>61-10024-00 22312-2A102 77 Ø 1,05 mm MLS</p> <p>61-10024-10 22311-2A102 77 Ø 1,1 mm MLS </p> <p>61-10024-20 22313-2A102 77 Ø 1,15 mm MLS </p> 	<p>14-10373-01 22321-2A110 (10x)</p> 	<p>15-10019-01 22441-2A102 +22443-2A100 (4x) +22441-2A021 (5x)</p> 	<p>12-10143-01 22224-2A100 (16x)</p>  <p>70-10143-00 22224-2A100</p> 	<p>71-10154-00 </p>  <p>71-12443-00 </p> 	<p>70-31414-10</p> 	<p>81-10382-00 </p>  <p>81-53343-00 </p> 























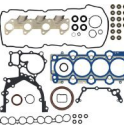
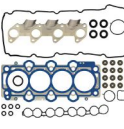

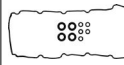











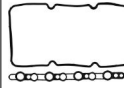
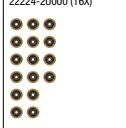















KIA															
1.5	D4FA	65-81 kW (88-110 PS)	RIO II CRDi	03/05-12/11 [NEW]	01-10241-01 20910-2AK10A 10/10	02-10241-01 20920-2AK10 12/08		04-10384-01	61-10024-00 22312-2A102 77 Ø 1,05 mm MLS	14-10373-01 22321-2A110 (10x) 	15-10019-01 22441-2A102 +22443-2A100 (4X) +22441-2A021 (5X) 	12-10143-01 22224-2A100 (16x) 	71-10154-00 28355-2A101 	70-31414-10 	81-10382-00 21361-2A200 41x53 A SL RD FPM 81-53343-00 21443-2A200 91x111 A SL LD MVQ
1.6	B4ZE	75 kW (102 PS)	CERATO I	04/04-12/09					61-53965-00 22311-26603 77 Ø 	14-55096-01 22321-26000 (10x) 	15-53967-01 22441-26020 +22442-23500 (2X) 	12-53678-01 22224-23500 (16x) 	71-17066-00 28411-26600 71-53971-00 28521-26600 		81-53972-00 21421-22020 35x48 A SL RD FPM 81-53306-00 21443-22000 72x96 A SL LD MVQ 81-53246-00 22144-38001 35x50 A SL RD FPM
1.6	B6	59 kW (80 PS)	SEPHIA	09/93-10/97	01-53890-01 0K20W 10 270B 	02-53890-01 			61-53890-00 0B61L 10 271A 1,2 mm 		71-53923-00 0K2A1 10 235A 	12-53924-01 MB630 10 155 (6x) 	71-53926-00 0K201 13 111 71-53927-00 0K201 13 460A 	10-53403-01 21521 2X000 +21522 2X000 	81-53253-00 0B3C7 10 602B 36,5x50,5 A SL RD MVQ 81-53404-00 0K201 11 312 83x100 A SL LD MVQ 81-53228-00 KKY01 12 602 30x44 A SL RD NBR

KIA															
1,6	D4FB	66 kW (90 PS)	PRO CEED CRDI	02/08-09/12	<p>01-10015-01 KSR62-10270 1 ⇒ 02/08</p>  <p>01-10101-02 20910-2AJ00 1 ⇒ 03/08 →</p> 	<p>02-10101-02 20920-2AJ00</p> 			<p>61-10101-00 22311-2A601 78,2 Ø 1 mm MLS</p> <p>61-10101-10 22313-2A601 78,2 Ø 1,05 mm MLS</p>	<p>14-10373-01 22321-2A110 (10x)</p> 	<p>15-10019-01 22441-2A102 +22443-2A100 (4X) +22441-2A021 (5X)</p> 	<p>12-10143-01 22224-2A100 (16x)</p>  <p>70-10143-00 22224-2A100</p>	<p>71-10154-00 </p> <p>28355-2A101</p>  <p>71-12443-00 </p> <p>28521-2A100</p> 	<p>70-31414-10</p> 	<p>81-10382-00 </p> <p>21361-2A200 41x53 A SL RD FPM</p>  <p>81-53343-00 </p> <p>21443-2A200 91x111 A SL LD MVQ</p> 
1,6	D4FB D4FB-L	66-85 kW (90-115 PS)	CEED CRDi	12/06 (NEW)	<p>01-10015-01 KSR62-10270 1 ⇒ 02/08</p>  <p>01-10101-02 20910-2AJ00 1 ⇒ 03/08 →</p> 	<p>02-10101-02 20920-2AJ00</p> 	<p>04-10384-01 </p> <p>1 ⇒ 07/09</p> 	<p>61-10101-00 22311-2A601 78,2 Ø 1 mm MLS</p> <p>61-10101-10 22313-2A601 78,2 Ø 1,05 mm MLS</p>	<p>14-10373-01 22321-2A110 (10x)</p> 	<p>15-10019-01 22441-2A102 +22443-2A100 (4X) +22441-2A021 (5X)</p> 	<p>12-10143-01 22224-2A100 (16x)</p>  <p>70-10143-00 22224-2A100</p>	<p>71-10154-00 </p> <p>28355-2A101</p>  <p>71-12443-00 </p> <p>28521-2A100</p> 	<p>70-31414-10</p> 	<p>81-10382-00 </p> <p>21361-2A200 41x53 A SL RD FPM</p>  <p>81-53343-00 </p> <p>21443-2A200 91x111 A SL LD MVQ</p> 	
1,6	D4FB	81-94 kW (110-128 PS)	CEED CRDi PRO CEED CRDi	05/12-07/18	<p>01-10101-04 20910-2AJ00</p> 	<p>02-10101-04 20920-2AJ00</p> 		<p>61-10101-00 22311-2A601 78,2 Ø 1 mm MLS</p> <p>61-10101-10 22313-2A601 78,2 Ø 1,05 mm MLS</p>	<p>14-10373-01 22321-2A110 (10x) 1 ⇒ 10/13</p>  <p>14-11540-01 22321-2A600 (10X) 1 ⇒ 11/13 →</p> 	<p>15-10019-01 22441-2A102 +22443-2A100 (4X) +22441-2A021 (5X)</p> 	<p>12-10143-01 22224-2A100 (16x)</p>  <p>70-10143-00 22224-2A100</p>	<p>71-10150-00 </p> <p>28312-2A800</p>  <p>71-10149-00 </p> <p>28521-2A701</p> 	<p>70-31414-10</p> 	<p>81-10382-00 </p> <p>21361-2A200 41x53 A SL RD FPM</p>  <p>81-53343-00 </p> <p>21443-2A200 91x111 A SL LD MVQ</p> 	



























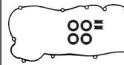





















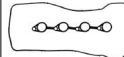
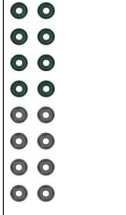

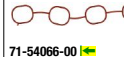

KIA														
1,6	D4FB	81-100 kW (110-136 PS)	CEED CRDi PRO CEED PRO CEED T-GDi STONIC CRDi	07/15	01-37740-03 20910-2AU04 	02-37740-03 20920-2AU04 		61-37740-00 22312-2A701 78 Ø 0,95 mm MLS	14-11540-01 22321-2A600 (10x) 	15-11242-01 22441-2A600 +22443-2A100 (4X) +22442-2A700 (5X) 	12-10143-01 22224-2A100 (16x) 	71-15701-00  28312-2A780 	70-31414-10 	81-10382-00  21361-2A200 41x53 A SL RD FPM  81-53343-00  21443-2A200 91x111 A SL LD MVQ 
1,6	D4FB	85 kW (115 PS)	CERATO I CRDi	06/05-06/08 [NEW]			04-10384-01 	61-10101-00 22311-2A601 78,2 Ø 1 mm MLS	14-10373-01 22321-2A110 (10x) 	15-10019-01 22441-2A102 +22443-2A100 (4X) +22441-2A021 (5X) 	12-10143-01 22224-2A100 (16x) 	71-10154-00  28355-2A101 	70-31414-10 	81-10382-00  21361-2A200 41x53 A SL RD FPM  81-53343-00  21443-2A200 91x111 A SL LD MVQ 
1,6	D4FB	85-94 kW (115-128 PS)	CERATO I CRDi	06/05-06/09 [NEW]			04-10384-01 	61-10101-00 22311-2A601 78,2 Ø 1 mm MLS	14-10373-01 22321-2A110 (10x) 	15-10019-01 22441-2A102 +22443-2A100 (4X) +22441-2A021 (5X) 	12-10143-01 22224-2A100 (16x) 	71-10154-00  28355-2A101 	70-31414-10 	81-10382-00  21361-2A200 41x53 A SL RD FPM  81-53343-00  21443-2A200 91x111 A SL LD MVQ 
1,6	D4FB	85-94 kW (115-128 PS)	CARENS III CRDi CEED CRDi SOUL I CRDi	02/09	01-10101-03 20910-2AM00 	02-10101-03 20920-2AM00 		61-10101-00 22311-2A601 78,2 Ø 1 mm MLS	14-10373-01 22321-2A110 (10x) 	15-10019-01 22441-2A102 +22443-2A100 (4X) +22441-2A021 (5X) 	12-10143-01 22224-2A100 (16x) 	71-10154-00  28355-2A101 	70-31414-10 	81-10382-00  21361-2A200 41x53 A SL RD FPM  81-53343-00  21443-2A200 91x111 A SL LD MVQ 

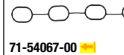
KIA															
Ltr.															
1,6	D4FB	85-94 kW (115-128 PS)	PRO CEED CRDI	02/08-09/12	01-10101-02 20910-2AJ00 	02-10101-02 20920-2AJ00 			61-10101-00 22311-2A601 78,2 Ø 1 mm MLS 1	14-10373-01 22321-2A110 (10x) 1 2	15-10019-01 22441-2A102 +22443-2A100 (4X) +22441-2A021 (5X) 1	12-10143-01 22224-2A100 (16x) 1 8x	71-10154-00 28355-2A101 71-12443-00 28521-2A100 	70-31414-10 	81-10382-00 21361-2A200 41x53 A SL RD FPM 81-53343-00 21443-2A200 91x111 A SL LD MVQ
1,6	D4FB	85-94 kW (116-128 PS)	VENGA CRDI	02/10	01-10101-03 20910-2AM00 10/11 → 01-10101-02 20910-2AJ00 10/11 → 	02-10101-03 20920-2AM00 10/11 → 02-10101-02 20920-2AJ00 10/11 → 			61-10101-00 22311-2A601 78,2 Ø 1 mm MLS 1	14-10373-01 22321-2A110 (10x) 10/13 → 1 2 14-11540-01 22321-2A600 (10X) 11/13 → 	15-10019-01 22441-2A102 +22443-2A100 (4X) +22441-2A021 (5X) 1	12-10143-01 22224-2A100 (16x) 1 8x	71-10154-00 28355-2A101 71-10149-00 28521-2A701 	70-31414-10 	81-10382-00 21361-2A200 41x53 A SL RD FPM 81-53343-00 21443-2A200 91x111 A SL LD MVQ
1,6	D4FB	94 kW (126 PS)	SOUL II CRDI	02/14	01-37740-04 20910-2AH02 07/14 → 01-37740-05 20910-2AH02B 08/14 → 	02-37740-04 20920-2AH02 			61-37740-00 22312-2A701 78 Ø 0,95 mm MLS 0	14-11540-01 22321-2A600 (10X) 0 1 2	15-10019-01 22441-2A102 +22443-2A100 (4X) +22441-2A021 (5X) 1	12-10143-01 22224-2A100 (16x) 1 8x	71-15701-00 28312-2A780 	70-31414-10 	81-10382-00 21361-2A200 41x53 A SL RD FPM 81-53343-00 21443-2A200 91x111 A SL LD MVQ





















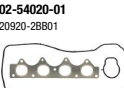

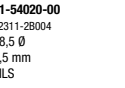

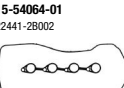
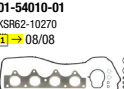

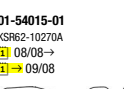

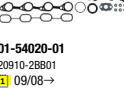

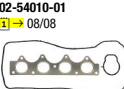
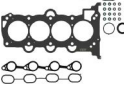
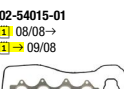
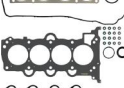
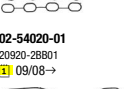
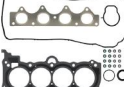

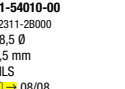

KIA

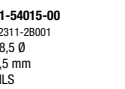
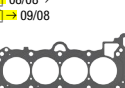
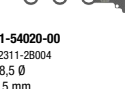
<p>Ltr. </p>											
<p>1,6 D4FB 100 kW (136 PS) SOUL II CRDi 04/15</p>	<p>01-37740-05 20910-2AH02B</p> 	<p>02-37740-04 20920-2AH02</p> 			<p>61-37740-00 22312-2A701 78 Ø 0,95 mm MLS</p> <p>61-37740-10 22311-2A701 78 Ø 1 mm MLS</p> <p>61-37740-20 22313-2A701 78 Ø 1,05 mm MLS</p> 	<p>14-11540-01 22321-2A600 (10X)</p> 	<p>15-10019-01 22441-2A102 +22443-2A100 (4X) +22441-2A021 (5X)</p> 	<p>12-10143-01 22224-2A100 (16x)</p>  <p>70-10143-00 22224-2A100</p> 	<p>71-15701-00 </p> <p>28312-2A780</p> 	<p>70-31414-10</p> 	<p>81-10382-00 </p> <p>21361-2A200 41x53 A SL RD FPM</p>  <p>81-53343-00 </p> <p>21443-2A200 91x111 A SL LD MVQ</p> 
<p>1,6 D4FE 85-100 kW (116-136 PS) CEED CRDi CEED T-GDi OPTIMA CRDi PRO CEED CRDi SPORTAGE IV CRDi SPORTAGE V CRDi STONIC CRDi XCEED CRDi 01/18 [NEW]</p>	<p>01-11337-01</p> 	<p>02-11337-01</p> 			<p>61-11322-00 22311-2U011 78 Ø 1,15 mm MLS</p> <p>61-11322-10 22311-2U001 78 Ø 1,2 mm MLS</p> <p>61-11322-20 22311-2U021 78 Ø 1,25 mm MLS</p> 	<p>14-21908-01 22321-2U000 (10X)</p>	<p>15-19247-01 22441-2U000 +22442-2U000</p> 	<p>12-19255-01 22224-2U000 (16X)</p>  <p>70-19255-00 22224-2U000</p> 	<p>71-19235-00 </p> <p>28312-2U000</p>  <p>71-19242-00 </p> <p>28513-2U000</p> 	<p>70-31414-10</p> 	<p>81-10638-00 </p> <p>21361-2U000 35x49 A SL RD FPM</p>  <p>81-10637-00 </p> <p>21443-2U000 91x111 A SL LD FPM</p> 
<p>1,6 G4ED 77 kW (105 PS) CERATO I 04/04-12/09</p>					<p>61-53965-00 22311-26603 77 Ø</p> 	<p>14-55096-01 22321-26000 (10x)</p> 	<p>15-53967-01 22441-26020 +22442-23500 (2X)</p> 	<p>12-53678-01 22224-23500 (16x)</p>  <p>70-53678-00 22224-23500</p> 	<p>71-17066-00 </p> <p>28411-26600</p>  <p>71-53971-00 </p> <p>28521-26600</p> 	<p>70-31414-10</p> 	<p>81-63972-00 </p> <p>21421-22020 35x48 A SL RD FPM</p>  <p>81-53306-00 </p> <p>21443-22000 72x96 A SL LD MVQ</p>  <p>81-53246-00 N</p> <p>22144-38001 35x50 A SL RD FPM</p> 

KIA

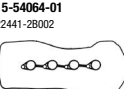
<p>Ltr.  1,6 G4ED 82 kW (112 PS) RIO II   03/05-12/11</p>											
<p>1,6 G4ED 82 kW (112 PS) RIO II 03/05-12/11</p>	<p>01-53965-03 KSR61 10 270</p> 				<p>61-53965-00 22311-26603 77 Ø</p> 	<p>14-55096-01 22321-26000 (10x)</p> 	<p>15-10104-01 22441-26801 +22443-23001 (4x) +22442-23500 (2x)</p> 	<p>12-53678-01 22224-23500 (16x)</p>  <p>70-53678-00 22224-23500</p>  <p>16x</p>	<p>71-10101-00 </p> <p>28411-26900</p>  <p>71-53971-00 </p> <p>28521-26600</p> 	<p>70-31414-10</p> 	<p>81-53872-00 </p> <p>21421-22020 35x48 A SL RD FPM</p>  <p>81-53306-00 </p> <p>21443-22000 72x96 A SL LD MVQ</p>  <p>81-53246-00 N</p> <p>22144-38001 35x50 A SL RD FPM</p> 
<p>1,6 G4FC 77-93 kW (105-126 PS) SOUL I 02/09-12/14</p>	<p>01-54020-01 20910-28801  07/11</p> 	<p>02-54020-01 20920-28801  07/11</p> 			<p>61-54020-00 22311-28004 78,5 Ø 0,5 mm MLS</p> 	<p>14-12343-01 22321-28000 (10x)  01/11</p>  <p>14-12196-01 22321-28700 (10x)  02/11 →</p> 	<p>15-54064-01 22441-28002  07/11</p> 	<p>12-54071-01 22224-28000 (8x) +22224-28010 (8x)</p>  <p>70-54071-00 AS 8x 22224-28001</p>  <p>70-54072-00 ES 8x 22224-28011</p> 	<p>71-11474-00 </p> <p>28411-28600  08/11 →</p>  <p>71-54066-00 </p> <p>28411-28500</p>  <p>71-54067-00 </p> <p>28521-28000</p> 	<p>70-31414-10</p> 	<p>81-54068-00 </p> <p>21421-28030 26x37,5 A SL RD FPM</p>  <p>81-54069-10 </p> <p>21443-28020 76x108 A SL LD FPM</p> 

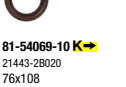
KIA

<p>Ltr.  1.6 G4FC</p>	<p>84-103 kW (114-140 PS)</p>	<p>CARENS III CEED CERATO II CERATO II Gdi</p>	<p> 06/09</p>								<p>1.6 G4FC</p>	<p>85-93 kW (115-126 PS)</p>	<p>CEED</p>	<p>12/06-12/12</p>							
<p>1.6 G4FC</p>	<p>85-93 kW (115-126 PS)</p>	<p>CEED</p>	<p>12/06-12/12</p>	<p>01-54020-01 20910-2B801</p>      	<p>02-54020-01 20920-2B801</p>      	<p>61-54020-00 22311-2B004 78,5 Ø 0,5 mm MLS</p>  	<p>15-54064-01 22441-2B002</p> 	<p>12-54071-01 22224-2B000 (8x) +22224-2B010 (8x)</p>     	<p>71-54066-00  28411-2B500</p>  <p>71-54067-00  28521-2B000</p> 	<p>70-31414-10</p>  <p>81-54068-00  21421-2B030 26x37,5 A SL RD FPM</p>  <p>81-54069-10  21443-2B020 76x108 A SL LD FPM</p> 											
<p>03 / 2023</p>														<p>26 von 63</p>							

KIA

Ltr.  1,6 G4FC 85-93 kW (116-126 PS) PRO CEED  02/08-09/12



01-54010-01
KSR62-10270
1 ⇒ 08/08

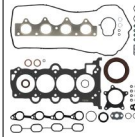

01-54015-01
KSR62-10270A
1 ⇒ 08/08 →
1 ⇒ 09/08

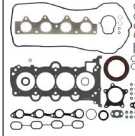

01-54020-01
20910-2B801
1 ⇒ 09/08 →

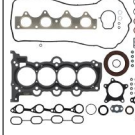

02-54010-01
1 ⇒ 08/08

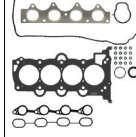

02-54015-01
1 ⇒ 08/08 →
1 ⇒ 09/08

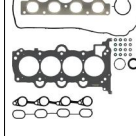

02-54020-01
20920-2B801
1 ⇒ 09/08 →

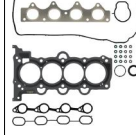

61-54010-00
22311-2B000
78,5 Ø
0,5 mm
MLS
1 ⇒ 08/08

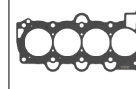

61-54015-00
22311-2B001
78,5 Ø
0,5 mm
MLS
1 ⇒ 08/08 →
1 ⇒ 09/08

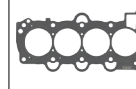

61-54020-00
22311-2B004
78,5 Ø
0,5 mm
MLS
1 ⇒ 09/08 →

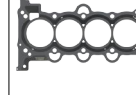

14-12343-01
22321-2B000 (10X)
1 ⇒ 10/11

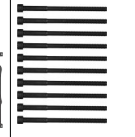

14-12196-01
22321-2B700 (10X)
1 ⇒ 11/11 →

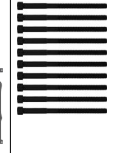

15-54064-01
22441-2B002

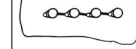

12-54071-01
22224-2B000 (8x)
+22224-2B010 (8x)

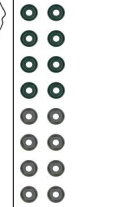

70-54071-00 AS 8x
22224-2B001



70-54072-00 ES 8x
22224-2B011

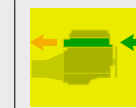

71-54066-00 1 ⇒
28411-2B500



71-54067-00 1 ⇒
28521-2B000



70-31414-10

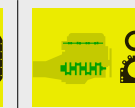
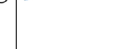

81-54068-00 K ⇒
21421-2B030
26x37,5
A SL RD FPM



81-54069-10 K ⇒
21443-2B020
76x108
A SL LD FPM



1,6 G4FC 87 kW (118 PS) CEED LPG 06/11-12/11

01-54020-01
20910-2B801

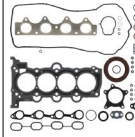

01-54020-04
20910-2B600A

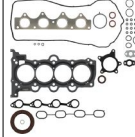

02-54020-01
20920-2B801



61-54020-00
22311-2B004
78,5 Ø
0,5 mm
MLS

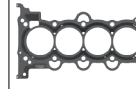

15-54064-01
22441-2B002

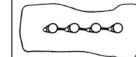

12-54071-01
22224-2B000 (8x)
+22224-2B010 (8x)

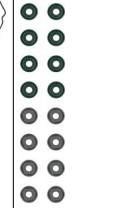

70-54071-00 AS 8x
22224-2B001



70-54072-00 ES 8x
22224-2B011



71-54066-00 1 ⇒
28411-2B500

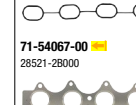

71-54067-00 1 ⇒
28521-2B000



70-31414-10





























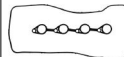

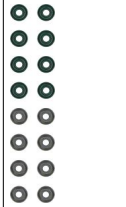















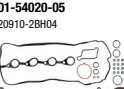

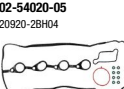



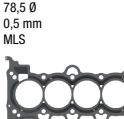
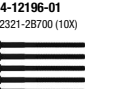

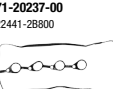





81-54068-00 K ⇒
21421-2B030
26x37,5
A SL RD FPM





81-54069-10 K ⇒
21443-2B020
76x108
A SL LD FPM



KIA

<p>Ltr. </p>	<p>1,6 G4FC 87 kW (118 PS)</p>	<p> SOUL I LPG</p>	<p> 06/11-12/14</p>		<p>01-54020-01 20910-2B801  ⇒ 07/11</p>			<p>02-54020-01 20920-2B801  ⇒ 07/11</p>							<p>61-54020-00 22311-2B004 78,5 Ø 0,5 mm MLS</p>			<p>14-12196-01 22321-2B700 (10X)</p>			<p>15-54064-01 22441-2B002  ⇒ 07/11</p>			<p>12-54071-01 22224-2B000 (8x) +22224-2B010 (8x)</p>		<p>70-54071-00 AS 8x 22224-2B001</p>	<p>70-54072-00 ES 8x 22224-2B011</p>			<p>71-11474-00   28411-2B600  08/11 →</p>		<p>71-54067-00  28521-2B000</p>			<p>70-31414-10 </p>			<p>81-54068-00  21421-2B030 26x37,5 A SL RD FPM</p>		<p>81-54069-10  21443-2B020 76x108 A SL LD FPM</p>	
<p>1,6 G4FC 89-96 kW (121-131 PS)</p>	<p>G4FG</p> <p>CCEED CERATO III CERATO III Mpi CERATO IV Mpi PRO CCEED RIO IV SELTOS Mpi SOUL I SOUL II SOUL II Mpi SOUL II MPI</p>		<p>06/11</p>		<p>01-54020-05 20910-2B804</p>			<p>02-54020-05 20920-2B804</p>				<p>61-54020-00 22311-2B004 78,5 Ø 0,5 mm MLS</p>			<p>14-12196-01 22321-2B700 (10X)</p>			<p>71-20237-00 22441-2B800</p>			<p>12-54071-01 22224-2B000 (8x) +22224-2B010 (8x)</p>		<p>70-54071-00 AS 8x 22224-2B001</p>	<p>70-54072-00 ES 8x 22224-2B011</p>			<p>71-11474-00   28411-2B600</p>		<p>71-54067-00  28521-2B000</p>			<p>70-31414-10 </p>			<p>81-54068-00  21421-2B030 26x37,5 A SL RD FPM</p>		<p>81-54069-10  21443-2B020 76x108 A SL LD FPM</p>				

KIA

Ltr.  1,6 G4FC 90 kW (122 PS) CERATO I  1 05/06-12/09

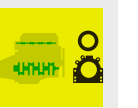
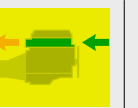

01-54010-01
KSR62-10270
 ⇒ 08/08







01-54015-01
KSR62-10270A
 ⇒ 08/08 →
 ⇒ 10/08



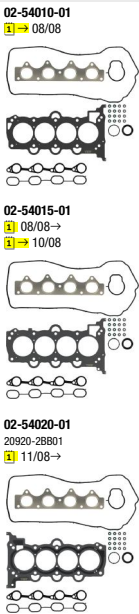
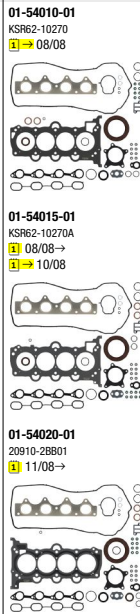





01-54020-01
20910-2B801
 ⇒ 11/08 →







61-54010-00
22311-2B000
78,5 Ø
0,5 mm
MLS
 ⇒ 08/08



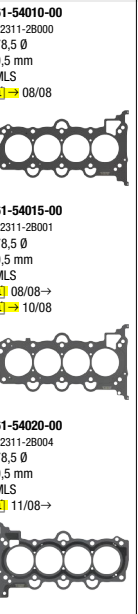

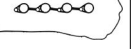

61-54015-00
22311-2B001
78,5 Ø
0,5 mm
MLS
 ⇒ 08/08 →
 ⇒ 10/08

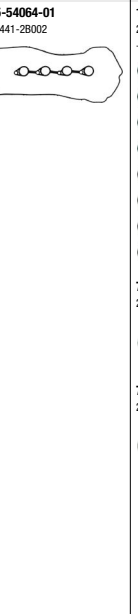

61-54020-00
22311-2B004
78,5 Ø
0,5 mm
MLS
 ⇒ 11/08 →



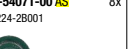

15-54064-01
22441-2B002



12-54071-01
22224-2B000 (8x)
+22224-2B010 (8x)





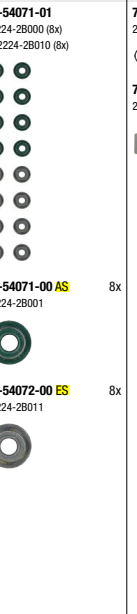

70-54071-00 AS 8x

70-54072-00 ES 8x



71-54066-00  ⇒
28411-2B500

71-54067-00  ⇒
28521-2B000



70-31414-10





81-54068-00  ⇒
21421-2B030
26x37,5
A SL RD FPM



81-54069-10  ⇒
21443-2B020
76x108
A SL LD FPM



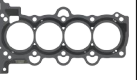

1,6 G4FC 90 kW (123 PS) RIO III 06/12-12/17

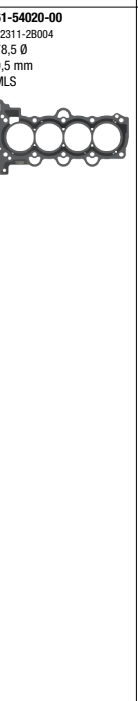

61-54020-00
22311-2B004
78,5 Ø
0,5 mm
MLS



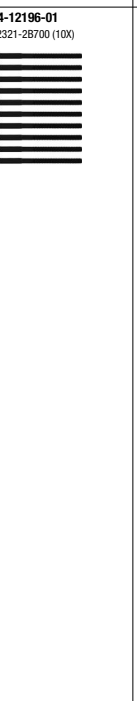





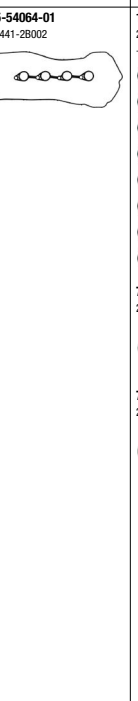

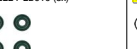
14-12196-01
22321-2B700 (10x)





15-54064-01
22441-2B002



12-54071-01
22224-2B000 (8x)
+22224-2B010 (8x)





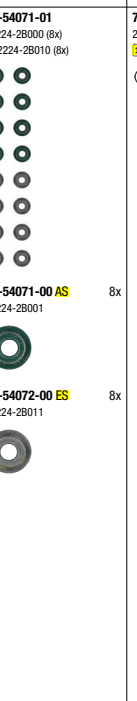

70-54071-00 AS 8x

70-54072-00 ES 8x



71-54066-00  ⇒
28411-2B500
 ⇒ 05/14 →



70-31414-10







81-54068-00  ⇒
21421-2B030
26x37,5
A SL RD FPM



81-54069-10  ⇒
21443-2B020
76x108
A SL LD FPM



KIA															
Ltr.															
1,6	G4FC	90-93 kW (122-126 PS)	02/09	<p>01-54020-01 20910-2B801</p>	<p>02-54020-01 20920-2B801</p>			<p>61-54020-00 22311-2B004 78,5 Ø 0,5 mm MLS</p>	<p>14-12343-01 22321-2B000 (10x) 1 ⇒ 01/11</p>	<p>15-54064-01 22441-2B002</p>	<p>12-54071-01 22224-2B000 (8x) +22224-2B010 (8x)</p>	<p>71-54066-00 </p> <p>28411-2B500</p>	<p>70-31414-10</p>	<p>81-54068-00 </p> <p>21421-2B030 26x37,5 A SL RD FPM</p>	
									<p>14-12196-01 22321-2B700 (10x) 1 ⇒ 02/11 →</p>		<p>70-54071-00 AS 8x 22224-2B001</p>	<p>71-54067-00 </p> <p>28521-2B000</p>		<p>81-54069-10 </p> <p>21443-2B020 76x108 A SL LD FPM</p>	
1,6	G4FC	91 kW (124 PS)	06/07-09/12	<p>01-54010-01 KSR62-10270 1 ⇒ 04/08</p>	<p>02-54010-01 1 ⇒ 04/08</p>			<p>61-54010-00 22311-2B000 78,5 Ø 0,5 mm MLS 1 ⇒ 04/08</p>		<p>15-54064-01 22441-2B002</p>	<p>12-54071-01 22224-2B000 (8x) +22224-2B010 (8x)</p>	<p>71-54066-00 </p> <p>28411-2B500</p>	<p>70-31414-10</p>	<p>81-54068-00 </p> <p>21421-2B030 26x37,5 A SL RD FPM</p>	
				<p>01-54015-01 KSR62-10270A 1 ⇒ 05/08 → 1 ⇒ 12/08</p>	<p>02-54015-01 1 ⇒ 05/08 → 1 ⇒ 12/08</p>			<p>61-54015-00 22311-2B001 78,5 Ø 0,5 mm MLS 1 ⇒ 05/08 → 1 ⇒ 12/08</p>			<p>70-54071-00 AS 8x 22224-2B001</p>	<p>71-54067-00 </p> <p>28521-2B000</p>		<p>81-54069-10 </p> <p>21443-2B020 76x108 A SL LD FPM</p>	
				<p>01-54020-01 20910-2B801 1 ⇒ 01/09 →</p>	<p>02-54020-01 20920-2B801 1 ⇒ 01/09 →</p>			<p>61-54020-00 22311-2B004 78,5 Ø 0,5 mm MLS 1 ⇒ 01/09 →</p>			<p>70-54072-00 ES 8x 22224-2B011</p>				
				<p>01-54020-04 20910-2B600A</p>											

KIA

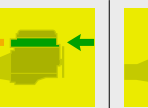
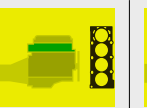
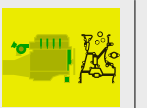
Ltr.  1.6 G4FC 92 kW (125 PS)  PRO CEED  10/10-02/13



20910-2B801

01-54020-01
20910-2B801



20920-2B801

02-54020-01
20920-2B801



61-54020-00
22311-2B004
78,5 Ø
0,5 mm
MLS

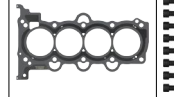

14-12343-01
22321-2B000 (10X)
10/11



14-12196-01
22321-2B700 (10X)
11/11 →



15-54064-01
22441-2B002

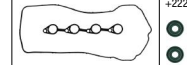

12-54071-01
22224-2B000 (8x)
+22224-2B010 (8x)

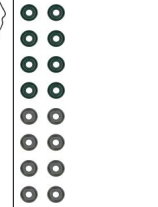

70-54071-00 AS 8x
22224-2B001



70-54072-00 ES 8x
22224-2B011



71-54066-00 1
28411-2B500

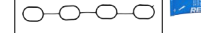

71-54067-00
28521-2B000



70-31414-10



81-54068-00 K
21421-2B030
26x37,5
A SL RD FPM



81-54069-10 K
21443-2B020
76x108
A SL LD FPM



20910-2B801

01-54020-01
20910-2B801
07/11



20920-2B801

02-54020-01
20920-2B801
07/11

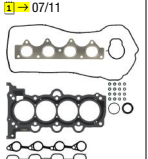

61-54020-00
22311-2B004
78,5 Ø
0,5 mm
MLS

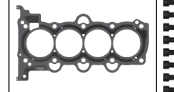

14-12343-01
22321-2B000 (10X)
01/11



14-12196-01
22321-2B700 (10X)
02/11 →



15-54064-01
22441-2B002
07/11

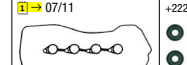

12-54071-01
22224-2B000 (8x)
+22224-2B010 (8x)

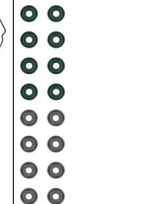

70-54071-00 AS 8x
22224-2B001



70-54072-00 ES 8x
22224-2B011



71-11474-00 1
28411-2B500
08/11 →



71-54067-00
28521-2B000



70-31414-10



81-54068-00 K
21421-2B030
26x37,5
A SL RD FPM

























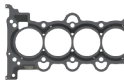

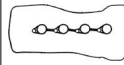



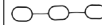







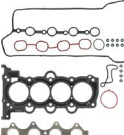

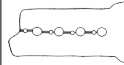



81-54069-10 K
21443-2B020
76x108
A SL LD FPM



























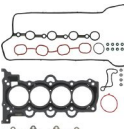
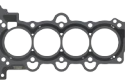

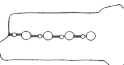















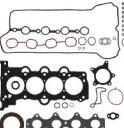

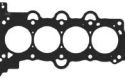







KIA															
Ltr.															
1,6	G4FC	92 kW (125 PS)	VENGA	02/10	01-54020-04 20910-2B600A 	02-54020-04 20920-2B600 			61-54020-00 22311-2B004 78,5 Ø 0,5 mm MLS 	14-12343-01 22321-2B000 (10X) 	15-54064-01 22441-2B002 	12-54071-01 22224-2B000 (8x) +22224-2B010 (8x) 70-54071-00 AS 8x 22224-2B001 70-54072-00 ES 8x 22224-2B011 	71-54066-00 28411-2B500 71-54067-00 28521-2B000 	70-31414-10 	81-54068-00 21421-2B030 26x37,5 A SL RD FPM 81-54069-10 21443-2B020 76x108 A SL LD FPM
1,6	G4FC	96 kW (131 PS)	CEED	11/14-07/18	01-54020-05 20910-2B004 	02-54020-05 20920-2B004 			61-54020-00 22311-2B004 78,5 Ø 0,5 mm MLS 	14-12196-01 22321-2B700 (10X) 	15-54064-01 22441-2B002 71-20237-00 22441-2B800 	12-54071-01 22224-2B000 (8x) +22224-2B010 (8x) 70-54071-00 AS 8x 22224-2B001 70-54072-00 ES 8x 22224-2B011 	71-11474-00 28411-2B600 71-54067-00 28521-2B000 	70-31414-10 	81-54068-00 21421-2B030 26x37,5 A SL RD FPM 81-54069-10 21443-2B020 76x108 A SL LD FPM





























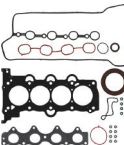

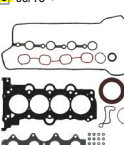

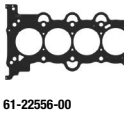

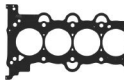















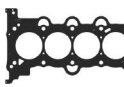













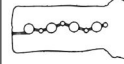

KIA

<p>Ltr. </p>											
<p>1,6 G4FC 96 kW (131 PS) CERATO II 05/13-02/14</p>	<p>01-54020-01 20910-2B801</p> 	<p>02-54020-01 20920-2B801</p> 			<p>61-54020-00 22311-2B004 78,5 Ø 0,5 mm MLS</p> 	<p>14-12196-01 22321-2B700 (10X)</p> 	<p>15-54064-01 22441-2B002</p> 	<p>12-54071-01 22224-2B000 (8x) +22224-2B010 (8x)</p>  <p>70-54071-00 AS 8x 22224-2B001</p>  <p>70-54072-00 ES 8x 22224-2B011</p> 	<p>71-54066-00  28411-2B500</p>  <p>71-54067-00  28521-2B000</p> 	<p>70-31414-10</p> 	<p>81-54068-00  21421-2B030 26x37,5 A SL RD FPM</p>  <p>81-54069-10  21443-2B020 76x108 A SL LD FPM</p> 
<p>1,6 G4FD 93-103 kW (126-140 PS) CARENS IV GDi CEED GDi CEED T-GDi PRO CEED GDi RIO III RIO IV SOUL I GDi SOUL II GDi SPORTAGE III GDi SPORTAGE III LPG SPORTAGE IV SPORTAGE IV GDi</p>	<p>01-54020-02 20910-2B801</p> 	<p>02-54020-02 20920-2B801</p> 			<p>61-54020-00 22311-2B004 78,5 Ø 0,5 mm MLS</p> 	<p>14-12196-01 22321-2B700 (10X)</p> 	<p>71-11475-00 22441-2B610</p> 	<p>12-54071-01 22224-2B000 (8x) +22224-2B010 (8x)</p>  <p>70-54071-00 AS 8x 22224-2B001</p>  <p>70-54072-00 ES 8x 22224-2B011</p> 	<p>71-11474-00  28411-2B600</p>  <p>71-54067-00  28521-2B000</p> 	<p>70-31414-10</p> 	<p>81-54068-00  21421-2B030 26x37,5 A SL RD FPM</p>  <p>81-54069-10  21443-2B020 76x108 A SL LD FPM</p> 

KIA

<p>Ltr.  1.6 G4FD  99 kW (135 PS)  SPORTAGE III GDI  02/11</p>											
<p>1,6 G4FD 99 kW (129 PS) SOUL II 07/16</p>	<p>01-54020-02 20910-2BK01</p> 	<p>02-54020-02 20920-2BK01</p> 			<p>61-54020-00 22311-2B004 78,5 Ø 0,5 mm MLS</p> 	<p>14-12196-01 22321-2B700 (10X)  12/11→</p> 	<p>71-11475-00 22441-2B610</p> 	<p>12-54071-01 22224-2B000 (8x) +22224-2B010 (8x)</p>  <p>70-54071-00 AS 8x 22224-2B001</p>  <p>70-54072-00 ES 8x 22224-2B011</p> 	<p>71-11474-00   28411-2B600</p>  <p>71-54067-00  28521-2B000</p> 	<p>70-31414-10</p> 	<p>81-54068-00  21421-2B030 26x37,5 A SL RD FPM</p>  <p>81-54069-10  21443-2B020 76x108 A SL LD FPM</p> 
<p>1,6 G4FG 95 kW (129 PS) SOUL II 07/16</p>	<p>01-54020-05 20910-2BH04</p> 	<p>02-54020-05 20920-2BH04</p> 					<p>71-20237-00 22441-2B600</p> 				
<p>1,6 G4FJ 130-150 kW (177-204 PS) CEED T-GDi CERATO IV T-GDi OPTIMA OPTIMA T-GDi PRO CEED T-GDi SELTOS T-GDi SOUL II T-GDi SPORTAGE IV T-GDi XCEED T-GDi</p>	<p>01-22556-01 20910-2B006</p> 	<p>02-22556-01 20920-2B006</p> 			<p>61-22556-00 22311-2B610 78,5 Ø MLS</p> 	<p>14-12196-01 22321-2B700 (10X)</p> 	<p>71-20237-00 22441-2B600</p> 	<p>12-54071-01 22224-2B000 (8x) +22224-2B010 (8x)</p>  <p>70-54071-00 AS 8x 22224-2B001</p>  <p>70-54072-00 ES 8x 22224-2B011</p> 	<p>71-11474-00   28411-2B600</p>  <p>71-17064-00  28521-2B700</p> 	<p>70-31414-10</p> 	<p>81-54068-00  21421-2B030 26x37,5 A SL RD FPM</p>  <p>81-54069-10  21443-2B020 76x108 A SL LD FPM</p> 

KIA

<p>Ltr. </p>	<p></p>	<p></p>	<p></p>	<p></p>	<p></p>	<p></p>	<p></p>	<p></p>	<p></p>	<p></p>	<p></p>
<p>1,6 G4FJ 150 kW (204 PS) CEED GT PRO CEED GT 06/13-07/18 </p>	<p>01-22555-01 20910-2B000  ⇒ 08/15</p>  <p>01-22556-01 20910-2B006  09/15→</p> 	<p>02-22555-01 20920-2B000  ⇒ 08/15</p>  <p>02-22556-01 20920-2B006  09/15→</p> 			<p>61-22555-00 20920-2B000 78,5 Ø MLS  ⇒ 08/15</p>  <p>61-22556-00 22311-2B610 78,5 Ø MLS  09/15→</p> 	<p>14-12196-01 22321-2B700 (10X)</p> 		<p>12-54071-01 22224-2B000 (8x) +22224-2B010 (8x)</p>  <p>70-54071-00 AS 8x 22224-2B001</p>  <p>70-54072-00 ES 8x 22224-2B011</p> 	<p>71-11474-00  ⇒ 28411-2B600</p>  <p>71-17064-00  ⇒ 28521-2B700</p> 	<p>70-31414-10</p> 	<p>81-54068-00  ⇒ 21421-2B030 26x37,5 A SL RD FPM</p>  <p>81-54069-10  ⇒ 21443-2B020 76x108 A SL LD FPM</p> 
<p>1,6 G4FJ 150 kW (204 PS) CERATO II T-GDI 12/13</p>	<p>01-22555-01 20910-2B000</p> 	<p>02-22555-01 20920-2B000</p> 			<p>61-22555-00 22311-2B600 78,5 Ø MLS</p> 	<p>14-12196-01 22321-2B700 (10X)</p> 		<p>12-54071-01 22224-2B000 (8x) +22224-2B010 (8x)</p>  <p>70-54071-00 AS 8x 22224-2B001</p>  <p>70-54072-00 ES 8x 22224-2B011</p> 	<p>71-11474-00  ⇒ 28411-2B600</p>  <p>71-17064-00  ⇒ 28521-2B700</p> 	<p>70-31414-10</p> 	<p>81-54068-00  ⇒ 21421-2B030 26x37,5 A SL RD FPM</p>  <p>81-54069-10  ⇒ 21443-2B020 76x108 A SL LD FPM</p> 
<p>1,6 G4LE 104 kW (141 PS) CEED GDI CEED T-GDI NIRO I GDI XCEED CRDI XCEED GDI 09/16</p>	<p>01-11303-01 20910-03004</p>	<p>02-11303-01 20920-03004</p>			<p>61-11303-00 22311-03HA0 73,5 Ø MLS</p> 	<p>71-18485-00 22441-03HA0</p> 	<p>12-54071-02 22224-2B001 (16x)</p>  <p>70-54071-00 16x 22224-2B001</p> 	<p>71-18479-00  ⇒ 4x 28411-04500</p>  <p>71-16664-00  ⇒ 28521-03610</p> 	<p>70-31414-10</p> 	<p>81-35144-00  ⇒ 21421-2E300 40x52 A SL RD FPM</p>  <p>81-54164-00  ⇒ 21443-03010 72x98 A SL LD FPM</p> 	

KIA

Ltr.  1,6 G4LE 104 kW (141 PS) NIRO I Gdi 09/16-08/22 

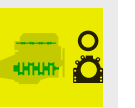
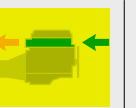
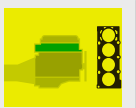

01-11303-01
20910-03U04
 02/19

02-11303-01
20920-03U04
 02/19

71-11303-00
22311-03HA0
73,5 Ø
MLS

71-18485-00
22441-03HA0

12-54071-02
22224-2B001 (16x)

71-18479-00  4x
28411-04500

70-31414-10 

81-35144-00 
21421-2E300
40x52
A SL RD FPM



71-16664-00 
28521-03610



81-54164-00 
21443-03010
72x98
A SL LD FPM



1,7 D4FD 85 kW (116 PS) CARENS IV CRDi SPORTAGE III CRDi 12/10

01-10101-01
20910-2AM02

02-10101-01
20920-2AM02

61-10101-00
22311-2A601
78,2 Ø
1 mm
MLS

61-10101-10 
22313-2A601
78,2 Ø
1,05 mm
MLS

14-10373-01
22321-2A110 (10x)
 10/13

14-11540-01
22321-2A600 (10x)
 11/13→

15-11242-01
22441-2A600
+22443-2A100 (4X)
+22442-2A700 (5X)

12-10143-01
22224-2A100 (16x)

70-10143-00
22224-2A100

71-10150-00 
28312-2A800

71-10149-00 
28521-2A701

70-31414-10 

81-10382-00 
21361-2A200
41x53
A SL RD FPM

81-53343-00 
21443-2A200
91x111
A SL LD MVQ

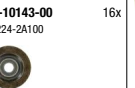
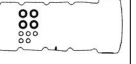
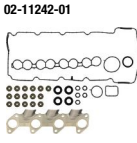
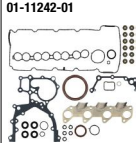
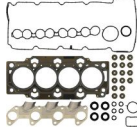

1,7 D4FD 85-100 kW (116-136 PS) CARENS IV CRDi 04/15

01-10101-01
20910-2AM02

02-10101-01
20920-2AM02

61-10101-00
22311-2A601
78,2 Ø
1 mm
MLS

61-10101-10 
22313-2A601
78,2 Ø
1,05 mm
MLS

14-11540-01
22321-2A600 (10x)



15-11242-01
22441-2A600
+22443-2A100 (4X)
+22442-2A700 (5X)

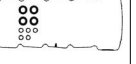

12-10143-01
22224-2A100 (16x)

70-10143-00
22224-2A100

71-10150-00 
28312-2A800

71-10149-00 
28521-2A701







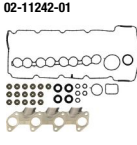
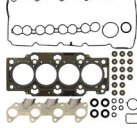
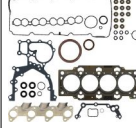

















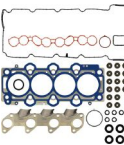

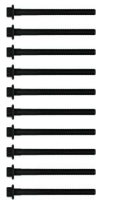
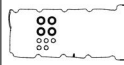
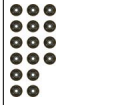









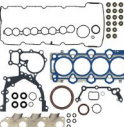
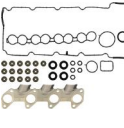
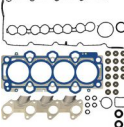



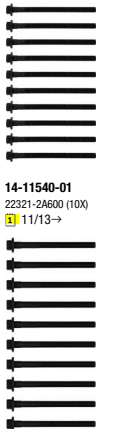

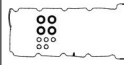
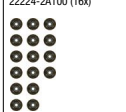









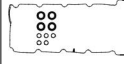
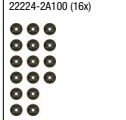

70-31414-10 

81-10382-00 
21361-2A200
41x53
A SL RD FPM

















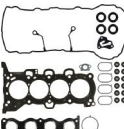









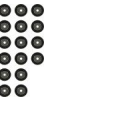













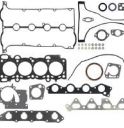

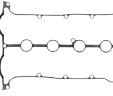













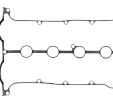

81-53343-00 
21443-2A200
91x111
A SL LD MVQ























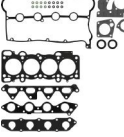

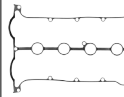
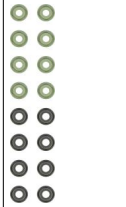















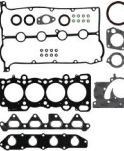
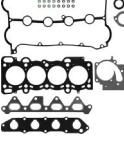

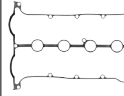
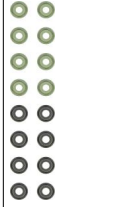



KIA

<p>Ltr.   </p>	<p>1,7 D4FD 85-104 kW (116-141 PS) SPORTAGE IV CRDi 09/15-09/22</p>											
<p>1,7 D4FD 85-104 kW (116-141 PS) SPORTAGE IV CRDi 09/15-09/22</p>	<p>01-37740-02 20910-2AH04</p> 	<p>02-37740-02 20920-2AH04</p> 			<p>61-37740-00 22312-2A701 78 Ø 0,95 mm MLS</p> <p>61-37740-10 22311-2A701 78 Ø 1 mm MLS</p> <p>61-37740-20 22313-2A701 78 Ø 1,05 mm MLS</p> 	<p>14-11540-01 22321-2A600 (10X)</p> 	<p>15-11242-01 22441-2A600 +22443-2A100 (4X) +22442-2A700 (5X)</p> 	<p>12-10143-01 22224-2A100 (16x)</p> 	<p>71-15701-00 </p> <p>28312-2A780</p>  <p>71-10149-00 </p> <p>28521-2A701</p>	<p>70-31414-10</p> 	<p>81-10382-00 </p> <p>21361-2A200 41x53 A SL RD FPM</p>  <p>81-53343-00 </p> <p>21443-2A200 91x111 A SL LD MVQ</p> 	
<p>1,7 D4FD 100 kW (136 PS) CARENS IV CRDi OPTIMA CRDi 03/12</p>	<p>01-11242-01</p>  <p>01-37740-01 20910-2AP00</p> 	<p>02-11242-01</p>  <p>02-37740-01 20920-2AP00</p> 			<p>61-37740-00 </p> <p>22312-2A701 78 Ø 0,95 mm MLS</p> <p>61-37740-10 22311-2A701 78 Ø 1 mm MLS</p> <p>61-37740-20 </p> <p>22313-2A701 78 Ø 1,05 mm MLS</p> 	<p>14-10373-01 22321-2A110 (10x)  ⇒ 10/13</p>  <p>14-11540-01 22321-2A600 (10X)  11/13 →</p>	<p>15-11242-01 22441-2A600 +22443-2A100 (4X) +22442-2A700 (5X)</p> 	<p>12-10143-01 22224-2A100 (16x)</p>  <p>70-10143-00 16x</p> 	<p>71-10150-00 </p> <p>28312-2A800</p>  <p>71-10149-00 </p> <p>28521-2A701</p> 	<p>70-31414-10</p> 	<p>81-10382-00 </p> <p>21361-2A200 41x53 A SL RD FPM</p>  <p>81-53343-00 </p> <p>21443-2A200 91x111 A SL LD MVQ</p> 	
<p>1,7 D4FD 104 kW (141 PS) CARENS IV CRDi OPTIMA CRDi 07/15</p>					<p>61-37740-00 22312-2A701 78 Ø 0,95 mm MLS</p> <p>61-37740-10 22311-2A701 78 Ø 1 mm MLS</p> <p>61-37740-20 22313-2A701 78 Ø 1,05 mm MLS</p> 	<p>14-11540-01 22321-2A600 (10X)</p> 	<p>15-11242-01 22441-2A600 +22443-2A100 (4X) +22442-2A700 (5X)</p> 	<p>12-10143-01 22224-2A100 (16x)</p> 	<p>71-15701-00 </p> <p>28312-2A780</p>  <p>71-17067-00 </p> <p>28521-2A702</p> 	<p>70-31414-10</p> 	<p>81-10382-00 </p> <p>21361-2A200 41x53 A SL RD FPM</p>  <p>81-53343-00 </p> <p>21443-2A200 91x111 A SL LD MVQ</p> 	



KIA

<p>Ltr.  1,8 G4NB 110 kW (150 PS) CERATO III  04/13 </p>	 01-11315-01 20910-2EA00 	 02-11315-01 20920-2EA00 			 61-11315-00 22311-2E000 82,5 Ø MLS 	 14-19042-01 	 15-18984-01 	 12-10122-01 22224-2G000 (16x)  70-10122-00 22224-2E000 16x 	 71-18980-00  4x 28313-2E050  71-18977-00  28521-2E000 	 70-31414-10 	 81-35144-00  21421-2E300 40x52 A SL RD FPM  81-10632-00  21443-2E000 85x119 A SL LD FPM 
<p>1,8 OK24N 81 kW (110 PS) OK26Y</p>	01-53385-03 OK9A0 10 270B 				61-53385-00 OK247 10 271C 81,5 Ø MLS 	14-55095-01 OK247 10 135 (10x)	71-53481-00 OK247 10 235B 	12-54581-01 OKL01 10 155 (8x) +OKL02 10 155 (8x)  70-54281-00 ES 8x OKL01 10 155  70-54282-00 AS 8x OKL02 10 155 	71-53478-10  OK247 13 135D  71-53479-00  OK247 13 111A  71-53476-00  OK2AA-13460 	70-31414-10 	81-53253-00  OK3C7 10 602B 36,5x50,5 A SL RD MVQ  81-53541-00  OK247 11 312 88x104 A LD MVQ  81-53243-00 N OFE01 10 602 34x48 A SL RD MVQ 
<p>1,8 TB 93 kW (126 PS) CARENS I CARENS II</p>							71-53481-00 OK247 10 235B 	12-54581-01 OKL01 10 155 (8x) +OKL02 10 155 (8x)  70-54281-00 ES 8x OKL01 10 155  70-54282-00 AS 8x OKL02 10 155 	71-53476-00  OK2AA-13460 	81-53253-00  OK3C7 10 602B 36,5x50,5 A SL RD MVQ  81-53541-00  OK247 11 312 88x104 A LD MVQ  81-53243-00 N OFE01 10 602 34x48 A SL RD MVQ 	

KIA

<p>Ltr.  1,8 T8</p>	<p>81 kW (110 PS)</p>	<p>SHUMA I</p>	<p>10/97-03/01</p>	<p></p>	<p></p>	<p></p>	<p></p>	<p></p>	<p></p>	<p></p>	<p></p>	<p></p>
<p>1,8 T8</p>	<p>81 kW (110 PS)</p>	<p>SHUMA I</p>	<p>10/97-03/01</p>	<p>01-53385-01 K0AB3-10270</p> 	<p>02-53385-01</p> 	<p>61-53385-00 OK247 10 271C 81,5 Ø MLS</p> 	<p>14-55095-01 OK247 10 135 (10x)</p>	<p>71-53481-00 OK247 10 235B</p> 	<p>12-54581-01 OKL01 10 155 (8x) +OKL02 10 155 (8x)</p>  <p>70-54281-00 ES 8x OKL01 10 155</p>  <p>70-54282-00 AS 8x OKL02 10 155</p> 	<p>71-53478-00   OK2A5 13 135</p>  <p>71-53479-00  OK247 13 111A</p>  <p>71-53476-00  OK2AA-13460</p> 	<p>70-31414-10</p> 	<p>81-53253-00  0B3C7 10 602B 36,5x50,5 A SL RD MVQ</p>  <p>81-53541-00  OK247 11 312 88x104 A LD MVQ</p>  <p>81-53243-00  0FE01 10 602 34x48 A SL RD MVQ</p> 
<p>1,8 T8</p>	<p>81-85 kW (110-116 PS)</p>	<p>CARENS I CLARUS</p>	<p>07/96</p>	<p>01-53385-02 OK2CA 10 270</p> 	<p>02-53385-02</p> 	<p>61-53385-00 OK247 10 271C 81,5 Ø MLS</p> 	<p>14-55095-01 OK247 10 135 (10x)</p>	<p>71-53481-00 OK247 10 235B</p> 	<p>12-54581-01 OKL01 10 155 (8x) +OKL02 10 155 (8x)</p>  <p>70-54281-00 ES 8x OKL01 10 155</p>  <p>70-54282-00 AS 8x OKL02 10 155</p> 	<p>71-53478-00   OK2A5 13 135</p>  <p>71-53476-00  OK2AA-13460</p> 	<p>70-31414-10</p> 	<p>81-53253-00  0B3C7 10 602B 36,5x50,5 A SL RD MVQ</p>  <p>81-53541-00  OK247 11 312 88x104 A LD MVQ</p>  <p>81-53243-00  0FE01 10 602 34x48 A SL RD MVQ</p> 

KIA

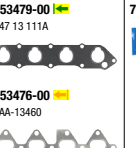
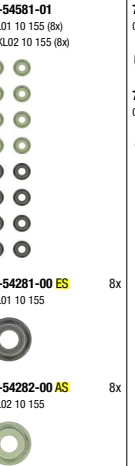
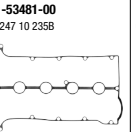
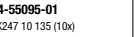
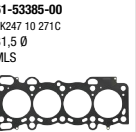
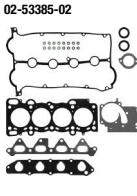
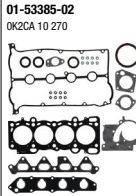
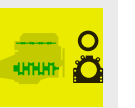
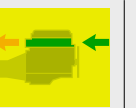

Ltr.  1.8 T8 81-85 kW (110-116 PS) CERATO SHUMA II  05/01-08/04



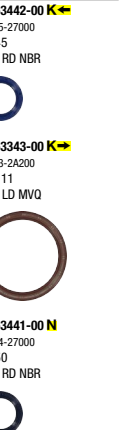
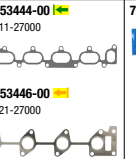
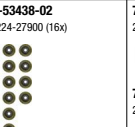
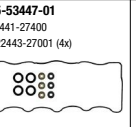
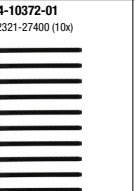
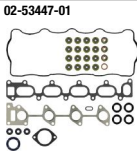

2.0 D4EA 83 kW (112 PS) CERATO I CRDI 04/04-05/06































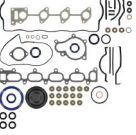

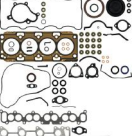



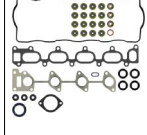



















KIA

Ltr.  2,0 D4EA 83 kW (113 PS)  CARENS CRDI  07/02



2,0 D4EA 83 kW (113 PS)  SPORTAGE II CRDI  09/04

				<p>61-53395-00 22311-27000 84 Ø 1,1 mm MLS  ⇒ 05/05</p> <p>61-53395-10 22311-27010 84 Ø 1,2 mm MLS  ⇒ 05/05</p> <p>61-53395-20 22311-27020 84 Ø 1,3 mm MLS  ⇒ 05/05</p> 	<p>14-10372-01 22321-27400 (10x)</p> 	<p>15-53447-01 22441-27400 +22443-27001 (4x)</p> 	<p>12-53438-02 22224-27900 (16x)</p> 	<p>71-53444-00 </p> <p>28411-27000</p>  <p>71-53446-00 </p> <p>28521-27000</p> 	<p>70-31414-10</p> 	<p>81-53442-00 </p> <p>21335-27000 32x45 A SL RD NBR</p>  <p>81-53343-00 </p> <p>21443-2A200 91x111 A SL LD MVQ</p>  <p>81-53441-00 </p> <p>22144-27000 36x50 A SL RD NBR</p> 
--	--	--	--	---	---	---	---	---	---	---

<p>01-53447-01  ⇒ 05/05</p>  <p>01-53447-02 20910-27610  06/05 →</p>  <p>01-53447-03  06/05 →</p> 	<p>02-53447-01  ⇒ 05/05</p>  <p>02-53447-02 20920-27610  06/05 →</p>  <p>02-53447-03  06/05 →</p> 			<p>61-53395-00 22311-27000 84 Ø 1,1 mm MLS  ⇒ 05/05</p> <p>61-53395-10 22311-27010 84 Ø 1,2 mm MLS  ⇒ 05/05</p> <p>61-53395-20 22311-27020 84 Ø 1,3 mm MLS  ⇒ 05/05</p>  <p>61-10010-00 22311-27401 84,5 Ø 1,1 mm MLS  06/05 →</p> <p>61-10010-10 22311-27411 84,5 Ø 1,2 mm MLS  06/05 →</p> <p>61-10010-20 22311-27421 84,5 Ø 1,3 mm MLS  06/05 →</p> 	<p>14-10372-01 22321-27400 (10x)</p> 	<p>15-53447-01 22441-27400 +22443-27001 (4x)</p> 	<p>12-53438-02 22224-27900 (16x)</p> 	<p>71-10105-00 </p> <p>28411-27400</p>  <p>71-53444-00 </p> <p>28411-27000</p>  <p>71-10106-00 </p> <p>28521-27400</p>  <p>71-53446-00 </p> <p>28521-27000</p> 	<p>70-31414-10</p> 	<p>81-53442-00 </p> <p>21335-27000 32x45 A SL RD NBR</p>  <p>81-53343-00 </p> <p>21443-2A200 91x111 A SL LD MVQ</p>  <p>81-53441-00 </p> <p>22144-27000 36x50 A SL RD NBR</p> 
--	--	--	--	--	---	---	---	---	---	---

KIA

Ltr.  2,0 D4EA 85-103 kW (115-140 PS) CARENS III CRDI  11/05



61-10010-00
22311-27401
84,5 Ø
1,1 mm
MLS

61-10010-10
22311-27411
84,5 Ø
1,2 mm
MLS

61-10010-20
22311-27421
84,5 Ø
1,3 mm
MLS

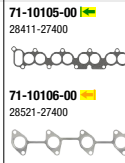
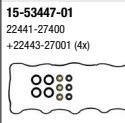



2,0 D4EA 100 kW (136 PS) CEED CRDi 06/07-12/12

01-53447-02
20910-27610
 02/09→



01-53447-03



02-53447-02
20920-27610
 02/09→

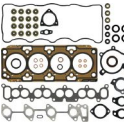

02-53447-03



61-53395-00
22311-27000
84 Ø
1,1 mm
MLS

61-53395-10
22311-27010
84 Ø
1,2 mm
MLS

61-53395-20
22311-27020
84 Ø
1,3 mm
MLS

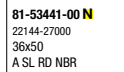
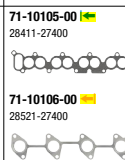
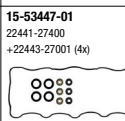
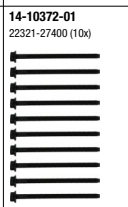























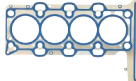

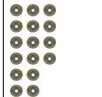

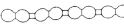







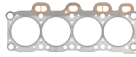
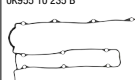
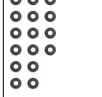











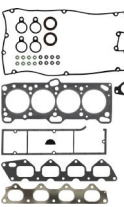

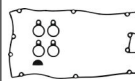
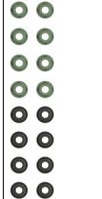



KIA













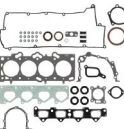







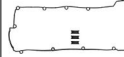













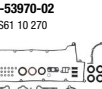
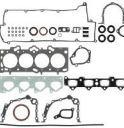
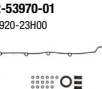
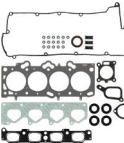



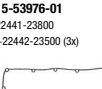
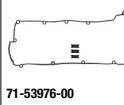
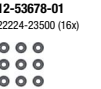

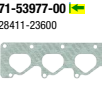

Ltr.	Motor	Power	Model	Year	Image 1	Image 2	Image 3	Image 4	Image 5	Image 6	Image 7	Image 8	Image 9	Image 10	Image 11
2,0	D4EA	100-110 kW (136-150 PS)	CARENS III CRDI MAGENTIS CRDI	11/05											
								<p>61-10010-00 22311-27401 84,5 Ø 1,1 mm MLS</p> <p>61-10010-10 22311-27411 84,5 Ø 1,2 mm 2 </p> <p>61-10010-20 22311-27421 84,5 Ø 1,3 mm 3 </p>		<p>15-53447-01 22441-27400 +22443-27001 (4x)</p>	<p>12-53438-02 22224-27900 (16x)</p>	<p>71-10105-00 </p> <p>28411-27400</p> <p>71-10106-00 </p> <p>28521-27400</p>	<p>70-31414-10</p>	<p>81-53442-00 </p> <p>21335-27000 32x45 A SL RD NBR</p> <p>81-53343-00 </p> <p>21443-2A200 91x111 A SL LD MVQ</p> <p>81-53441-00 N</p> <p>22144-27000 36x50 A SL RD NBR</p>	
2,0	D4EA	100-110 kW (136-150 PS)	SPORTAGE II CRDI	01/06	<p>01-53447-02 20910-27G10</p> <p>01-53447-03</p>	<p>02-53447-02 20920-27G10</p> <p>02-53447-03</p>			<p>61-10010-00 22311-27401 84,5 Ø 1,1 mm MLS</p> <p>61-10010-10 22311-27411 84,5 Ø 1,2 mm 2 </p> <p>61-10010-20 22311-27421 84,5 Ø 1,3 mm 3 </p>	<p>14-10372-01 22321-27400 (10x)</p>	<p>15-53447-01 22441-27400 +22443-27001 (4x)</p>	<p>12-53438-02 22224-27900 (16x)</p>	<p>71-10105-00 </p> <p>28411-27400</p> <p>71-10106-00 </p> <p>28521-27400</p>	<p>70-31414-10</p>	<p>81-53442-00 </p> <p>21335-27000 32x45 A SL RD NBR</p> <p>81-53343-00 </p> <p>21443-2A200 91x111 A SL LD MVQ</p> <p>81-53441-00 N</p> <p>22144-27000 36x50 A SL RD NBR</p>

KIA														
Ltr.														
2,0 D4EA	103 kW (140 PS)	07/07-12/12	CEED CRDI PRO CEED CRDI	01-53447-02 20910-27G10 01/09→ 	02-53447-02 20920-27G10 01/09→ 			61-10010-00 ✕ 22311-27401 84,5 Ø 1,1 mm MLS 61-10010-10 22311-27411 84,5 Ø 1,2 mm MLS 2 61-10010-20 ✕ 22311-27421 84,5 Ø 1,3 mm MLS 3 	14-10372-01 22321-27400 (10x) 	15-53447-01 22441-27400 +22443-27001 (4x) 	12-53438-02 22224-27900 (16x) 	71-10105-00 28411-27400 71-10106-00 28521-27400 	70-31414-10 	81-53442-00 K → 21335-27000 32x45 A SL RD NBR 81-53343-00 K → 21443-2A200 91x111 A SL LD MVQ 81-53441-00 N 22144-27000 36x50 A SL RD NBR
2,0 D4EA-F	100-110 kW (136-150 PS)			01-53447-02 20910-27G10 	02-53447-02 20920-27G10 			61-10010-00 ✕ 22311-27401 84,5 Ø 1,1 mm MLS 61-10010-10 22311-27411 84,5 Ø 1,2 mm MLS 2 61-10010-20 ✕ 22311-27421 84,5 Ø 1,3 mm MLS 3 	14-10372-01 22321-27400 (10x) 	15-53447-01 22441-27400 +22443-27001 (4x) 	12-53438-02 22224-27900 (16x) 	71-10105-00 28411-27400 71-10106-00 28521-27400 	70-31414-10 	81-53442-00 K → 21335-27000 32x45 A SL RD NBR 81-53343-00 K → 21443-2A200 91x111 A SL LD MVQ 81-53441-00 N 22144-27000 36x50 A SL RD NBR
2,0 D4HA	100-136 kW (136-185 PS)	07/10	SORENTO II CRDI SPORTAGE III CRDI SPORTAGE IV CRDI	01-10144-01 20910-2FH01 	02-10144-01 20920-2FH01 			61-10144-00 22311-2F610 85 Ø 1,2 mm MLS 61-10144-10 ✕ 22311-2F600 85 Ø 1,3 mm MLS 61-10144-20 ✕ 22311-2F620 85 Ø 1,4 mm MLS 	14-10371-01 22321-2F000 (10x) 	15-10001-01 22441-2F000 +22443-2F000 +22133-2F000 (4x) 	12-10130-01 22224-2F001 (16x) 70-10130-00 16x 	71-10127-00 28312-2F000 71-10128-00 28521-2F600 	70-31414-10 	81-10409-10 K → 21355-2FR00 60x72 A SL RD FPM



KIA





















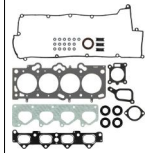

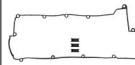



<p>Ltr.   </p>	<p>2,0 D4HA 135 kW (184 PS) SORENTO II CRDI 11/09-12/15</p>											
<p>2,0 D4HA 135 kW (184 PS) SORENTO II CRDI 11/09-12/15</p>	<p>61-10144-00 22311-2F610 85 Ø 1,2 mm MLS</p> <p>61-10144-10 22311-2F600 85 Ø 1,3 mm MLS</p> <p>61-10144-20 22311-2F620 85 Ø 1,4 mm MLS</p> 	<p>14-10371-01 22321-2F000 (10x)</p> 	<p>15-10001-01 22441-2F000 +22443-2F000 +22133-2F000 (4x)</p> 	<p>12-10130-01 22224-2F001 (16x)</p>  <p>70-10130-00 22224-2F001</p>  <p>16x</p>	<p>71-10127-00 </p> <p>28312-2F000</p>  <p>71-10128-00 </p> <p>28521-2F600</p> 	<p>70-31414-10</p> 	<p>81-10409-10 </p> <p>21355-2FR00 60x72 A SL RD FPM</p> 					
<p>2,0 FE (16V) 87-98 kW (118-133 PS) CLARUS RETONA SPORTAGE 04/94</p>	<p>01-53860-01 OK01C 10 270A</p> 	<p>02-53860-01</p> 	<p>61-53860-00 OK013 10 271 1,5 mm</p> 	<p>71-52434-00 OK955 10 235 B</p> 	<p>12-52829-01 OKL02 10 155 (16x)</p> 	<p>71-53054-00 </p> <p>OK9A4 13 111</p>  <p>71-53056-00 </p> <p>0FE3N 13 460</p> 	<p>70-31414-10</p> 	<p>81-53243-00 </p> <p>0FE01 10 602 34x48 A SL RD MVQ</p>  <p>81-53342-00 </p> <p>90x110 A SL LD NBR</p>  <p>81-53243-00 </p> <p>2x 0FE01 10 602 34x48 A SL RD MVQ</p> 				
<p>2,0 G4CP 88-102 kW (120-139 PS) JOICE 02/00</p>	<p>01-54145-01 20910-33F00</p> 	<p>02-54145-01 20920-33F00</p> 	<p>61-54145-00 22311-33110 86,5 Ø 1,4 mm</p> 	<p>15-54219-01 22441-33021 (1x) +22442-42001 (1x) +22443-33020 (4x)</p> 	<p>12-52718-05 22224-38000 (8x) +22224-38010 (8x)</p> 	<p>71-54221-00 </p> <p>21321-42031 28411-33012</p>  <p>71-52908-00 </p> <p>28521-33020</p> 	<p>70-31414-10</p> 	<p>81-53279-10 </p> <p>21321-42031 44x60 A SL RD FPM</p>  <p>81-53981-00 </p> <p>21443-33005 80x96 A SL LD FPM</p>  <p>81-53246-00 </p> <p>2x 22144-3B001 35x50 A SL RD FPM</p> 				

KIA















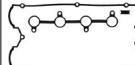

<p>Ltr. </p>	<p>2,0 G4GC 101-105 kW (137-143 PS)</p>	<p>CARENS II CERATO I SPORTAGE II</p>	<p>03/04 </p>		<p>01-53970-03 20910-23A00A</p>			<p>02-53970-01 20920-23H00</p>							<p>61-53970-00 22311-23700</p>					<p>15-53976-01 22441-23800 +22442-23500 (3x)</p>			<p>12-53678-01 22224-23500 (16x)</p>			<p>71-53977-00  28411-23600</p>			<p>70-31414-10 </p>			<p>81-53979-00  21421-23020 37,6x49 A SL RD FPM</p>			<p>81-53981-00  21443-33005 80x96 A SL LD FPM</p>			<p>81-53246-00 N 22144-3B001 35x50 A SL RD FPM</p>																							
<p>2,0 G4GC 105 kW (143 PS)</p>	<p>CEED PRO CEED PRO CEED LPG</p>	<p>12/06-12/12</p>			<p>01-53970-02 KSS61 10 270</p>			<p>02-53970-01 20920-23H00</p>					<p>61-53970-00 22311-23700</p>					<p>15-53976-01 22441-23800 +22442-23500 (3x)</p>			<p>12-53678-01 22224-23500 (16x)</p>			<p>71-53977-00  28411-23600</p>			<p>71-53978-00  28521-23005</p>			<p>70-31414-10 </p>			<p>81-53979-00  21421-23020 37,6x49 A SL RD FPM</p>			<p>81-53981-00  21443-33005 80x96 A SL LD FPM</p>			<p>81-53246-00 N 22144-3B001 35x50 A SL RD FPM</p>																						

KIA











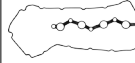

Ltr.  2,0 G4GC 106 kW (144 PS) SOUL I  09/09-12/11  1

										
	<p>02-53970-01 20920-23H00</p> 			<p>61-53970-00 22311-23700</p> 		<p>15-53976-01 22441-23800 +22442-23500 (3x)</p>  <p>71-53976-00 22441-23800</p> 	<p>12-53678-01 22224-23500 (16x)</p>  <p>70-53678-00 22224-23500</p> 	<p>71-53977-00 </p> <p>284111-23600</p>  <p>71-53978-00 </p> <p>28521-23005</p> 	<p>70-31414-10</p> 	<p>81-53979-00 </p> <p>21421-23020 37,6x49 A SL RD FPM</p>  <p>81-53981-00 </p> <p>21443-33005 80x96 A SL LD FPM</p>  <p>81-53246-00 N</p> <p>22144-38001 35x50 A SL RD FPM</p> 

2,0 G4JP 100 kW (136 PS) MAGENTIS I 05/01-09/05

				<p>61-53410-00 22311-38100 86 Ø MLS</p> 	<p>14-55075-01 22320-38000 (10x)</p> 	<p>15-53484-01 22441-38003 +22442-23500 +22443-38010 (4x)</p> 	<p>12-52718-02 22224-38010 (16x)</p>  <p>70-52718-00 22224-38010</p> 	<p>71-53483-00 </p> <p>284111-38000</p>  <p>71-52908-00 </p> <p>28521-33020</p> 	<p>70-31414-10</p> 	<p>81-53279-10 </p> <p>21321-42031 44x60 A SL RD FPM</p>  <p>81-53331-00 </p> <p>21443-38010 85x103 A SL LD MVQ</p>  <p>81-53246-00 N</p> <p>22144-38001 35x50 A SL RD FPM</p> 
---	---	--	--	--	---	--	--	---	---	--























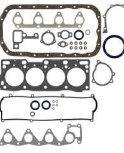

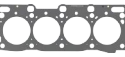



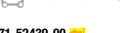









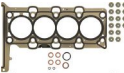

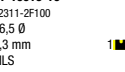
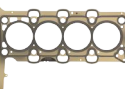

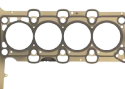





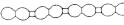





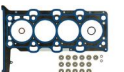
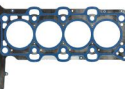
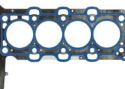
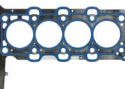

2,0 G4KD 110-118 kW (150-160 PS) CERATO II 01/09

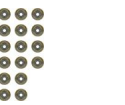
				<p>61-10141-00 22311-25013 87,8 Ø MLS</p> 		<p>71-10110-00 22441-26100</p> 	<p>12-10122-01 22224-26000 (16x)</p>  <p>70-10122-00 22224-2E000</p> 	<p>71-10116-00 </p> <p>28313-26000</p>  <p>71-10118-00 </p> <p>28314-26000</p>  <p>71-10111-00 </p> <p>28521-25010</p> 		<p>81-33489-10 </p> <p>21421-25002 42x55 RD FPM</p>  <p>81-54098-00 </p> <p>21443-26000 85x103 A SL LD FPM</p> 
--	--	--	--	--	--	---	--	--	--	--

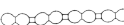

















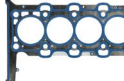





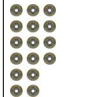



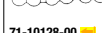







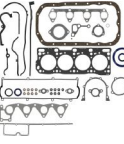
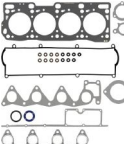





















KIA															
Ltr.															
2,0	G4KD	110-122 kW (150-166 PS)	SPORTAGE III	06/10	01-10141-01 20910-26L02 [1] ⇒ 11/13 	02-10141-01 20920-26L02 [1] ⇒ 11/13 			61-10141-00 22311-25013 87,8 Ø MLS [1] ⇒ 11/13 	14-10383-01 22320-25000 (8x) +22321-25001 (2x) [1] ⇒ 11/13 	71-10110-00 22441-26100 [1] ⇒ 11/13 	12-10122-01 22224-26000 (16x) 	71-10116-00 [K↔] 28313-26000 [1] ⇒ 11/13 	70-31414-10 	81-33489-10 [K↔] 21421-25002 42x55 RD FPM [1] ⇒ 11/13
2,0	G4KD	110-131 kW (150-178 PS)	OPTIMA SPORTAGE III	01/11	01-10141-01 20910-26L02 	02-10141-01 20920-26L02 			61-10141-00 22311-25013 87,8 Ø MLS 	14-10383-01 22320-25000 (8x) +22321-25001 (2x) 	71-10110-00 22441-26100 	12-10122-01 22224-26000 (16x) 	71-10116-00 [K↔] 28313-26000 	70-31414-10 	81-33489-10 [K↔] 21421-25002 42x55 RD FPM
2,0	G4NA	110 kW (150 PS)	SOUL II	08/16	01-11335-01 20910-2EU14 [1] 02/18→ 	02-11335-01 20920-2EU14 			61-11335-00 22311-2E100 82,5 Ø MLS 	14-19042-01 	15-18984-01 	12-10122-01 22224-26000 (16x) 	71-18980-00 [K↔] 28313-2E050 	70-31414-10 	81-35144-00 [K↔] 21421-2E300 40x52 A SL RD FPM
2,0	G4NA	110-114 kW (150-155 PS)	SPORTAGE IV	12/15-09/22	01-11335-01 20910-2EU14 [1] 02/18→ 	02-11334-01 20920-2EU07 [1] ⇒ 02/18 			61-11334-00 22311-2E080 82,5 Ø MLS [1] ⇒ 04/18 	14-19042-01 	15-18984-01 	12-10122-01 22224-26000 (16x) 	71-18980-00 [K↔] 28313-2E050 	70-31414-10 	81-35144-00 [K↔] 21421-2E300 40x52 A SL RD FPM
						02-11335-01 20920-2EU14 [1] 02/18→ 			61-11335-00 22311-2E100 82,5 Ø MLS [1] 04/18→ 			71-18977-00 [K↔] 28521-2E000 [1] ⇒ 11/19 		81-10632-00 [K↔] 21443-2E000 85x119 A SL LD FPM 	

KIA															
Ltr.															
2,0 G4NA G4ND G4NH	110-120 kW (150-163 PS)	09/15	CERATO III Mpi CERATO IV Mpi OPTIMA SELTOS Mpi SOUL II MPI												
2,0 G4NA G4NC	110-122 kW (150-166 PS)	01/14	SPORTAGE III SPORTAGE III GDI												
2,0 G4NA	112-113 kW (152-154 PS)	02/14	SOUL II												
2,0 G4NC	110-130 kW (150-177 PS)	03/13	CARENS IV CARENS IV GDI												























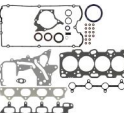
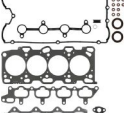















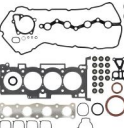
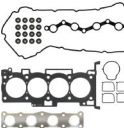
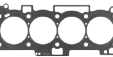

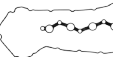















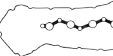



KIA

<p>Ltr.  2,0 RF</p>	<p>61-64 kW (83-87 PS)</p>	<p>RETONA TD SPORTAGE TD SPORTAGE VTDI</p>	<p>04/94-10/03</p>	<p></p>	<p></p>	<p></p>	<p></p>	<p></p>	<p></p>	<p></p>	<p></p>	<p></p>	<p></p>	<p></p>
<p>2,0 RF</p>	<p>61-64 kW (83-87 PS)</p>	<p>RETONA TD SPORTAGE TD SPORTAGE VTDI</p>	<p>04/94-10/03</p>	<p>01-53115-01 </p>	<p>02-53115-01 </p>	<p>61-53115-00 OK054 10 271 87,6 Ø MLS </p>	<p>71-52291-00 OK770 10 235B </p>	<p>12-52722-01 </p>	<p>71-52438-00  OK054 13 111 </p> <p>71-52439-00  OK054 13 460B </p>	<p>71-52272-00 </p>	<p>81-53243-00  OFE01 10 602 34x48 A SL RD MVQ </p> <p>81-53342-00  90x110 A SL LD NBR </p> <p>81-53243-00  OFE01 10 602 34x48 A SL RD MVQ </p>			
<p>2,2 D4HB</p>	<p>110-147 kW (150-200 PS)</p>	<p>CARNIVAL CRDi SORENTO II CRDi SORENTO III CRDi</p>	<p>11/09</p>	<p>01-10016-01 20910-2FU01 </p>	<p>02-10016-01 20920-2FU01 </p>	<p>61-10016-00  22311-2F110 86,5 Ø 1,2 mm MLS </p> <p>61-10016-10 22311-2F100 86,5 Ø 1,3 mm MLS </p> <p>61-10016-20  22311-2F120 86,5 Ø 1,4 mm MLS </p>	<p>14-10371-01 22321-2F000 (10x) </p>	<p>15-10001-01 22441-2F000 +22443-2F000 +22133-2F000 (4x) </p>	<p>12-10130-01 22224-2F001 (16x) </p> <p>70-10130-00 22224-2F001 </p>	<p>71-10127-00  28312-2F000 </p> <p>71-10128-00  28521-2F600 </p>	<p>70-31414-10 </p>	<p>81-10409-10  21355-2FRCo 60x72 A SL RD FPM </p>		
<p>2,2 D4HB</p>	<p>145-147 kW (197-200 PS)</p>	<p>SORENTO III CRDi</p>	<p>01/15</p>	<p>01-10016-02 </p> <p>01-10248-01 20910-2FH00 </p>	<p>02-10016-02 </p> <p>02-10248-01 20920-2FH00 </p>	<p>61-10248-00 22311-2F660 86,2 Ø 1,2 mm MLS </p> <p>61-10248-10 22311-2F650 86,2 Ø 1,3 mm MLS </p> <p>61-10248-20 22311-2F670 86,2 Ø 1,4 mm MLS </p>	<p>14-10371-01 22321-2F000 (10x) </p>	<p>15-10001-01 22441-2F000 +22443-2F000 +22133-2F000 (4x) </p>	<p>12-10130-01 22224-2F001 (16x) </p> <p>70-10130-00 22224-2F001 </p>	<p>71-10127-00  28312-2F000 </p> <p>71-10128-00  28521-2F600 </p>	<p>70-31414-10 </p>	<p>81-10409-10  21355-2FRCo 60x72 A SL RD FPM </p>		

KIA

<p>Ltr.  D4HC 147 kW (200 PS)  STINGER CRDi  06/17</p>					 <p>61-10248-00 22311-2F660 86,2 Ø 1,2 mm MLS</p> <p>61-10248-10 22311-2F650 86,2 Ø 1,3 mm MLS</p> <p>61-10248-20 22311-2F670 86,2 Ø 1,4 mm MLS</p> 	 <p>14-10371-01 22321-2F000 (10x)</p> 	 <p>15-10001-01 22441-2F000 +22443-2F000 +22133-2F000 (4x)</p> 	 <p>12-10130-01 22224-2F001 (16x)</p>  <p>70-10130-00 22224-2F001</p>  <p>16x</p>	 <p>71-10127-00  </p> <p>28312-2F000</p>  <p>71-10128-00 </p> <p>28521-2F600</p> 	 <p>70-31414-10</p> 	 <p>81-10409-10 </p> <p>21355-2FR00 60x72 A SL RD FPM</p> 
<p>2,2 R2 48-52 kW (65-70 PS)  BESTA D 07/92-12/03</p>	<p>01-52440-03</p> 	<p>02-52440-03</p> 			<p>61-52440-10 0R286-10271A 87,5 Ø MLS</p> 	<p>71-52291-00 0K770 10 235B</p> 	<p>12-52722-01</p> 	<p>71-52438-00 </p> <p>0K054 13 111</p>  <p>71-52439-00 </p> <p>0K054 13 460B</p> 	<p>71-52272-00</p> 	<p>81-53243-00 </p> <p>0FE01 10 602 34x48 A SL RD MVQ</p>  <p>81-53342-00 </p> <p>90x110 A SL LD NBR</p>  <p>81-53228-00 </p> <p>KKY01 12 602 30x44 A SL RD NBR</p> 	
<p>2,4 D4BH 69 kW (94 PS)  BONGO TDCi 10/03</p>					<p>61-52252-10 22311-42515 92,5 Ø 1,45 mm </p> <p>61-52252-20 22311-42855 92,5 Ø 1,5 mm </p> <p>61-52252-30 22311-42525 92,5 Ø 1,55 mm </p> 	<p>14-55015-01 22321-32000 (18x)</p> 	<p>15-52244-02</p> 	<p>12-52906-01</p> 	<p>71-53732-00  </p> <p>28520-42070</p> 	<p>70-31414-10</p> 	<p>81-53279-10 </p> <p>21321-42031 44x60 A SL RD FPM</p>  <p>81-53322-10 </p> <p>21321-42041 80x96 A SL LD FPM</p>  <p>81-53246-00 </p> <p>22144-3B001 35x50 A SL RD FPM</p> 

KIA

<p>Ltr.  2,4 G4JS 102 kW (139 PS) SORENTO I  08/02-06/09</p>											
<p>2,4 G4JS 102 kW (139 PS) SORENTO I 08/02-06/09</p>	<p>01-53615-01 K0AH2 10 270</p> 	<p>02-53615-01</p> 			<p>61-53615-00 22311-38400 87,7 Ø 0,42 mm MLS</p> 		<p>15-53484-01 22441-38003 +22442-23500 +22443-38010 (4x)</p> 	<p>12-52718-02 22224-38010 (16x)</p>  <p>16x</p> <p>70-52718-00 22224-38010</p> 	<p>71-53483-00   28411-38000</p>  <p>71-52908-00  28521-33020</p> 	<p>70-31414-10</p> 	<p>81-53279-10  21321-42031 44x60 A SL RD FPM</p>  <p>81-53331-00  21443-38010 85x103 A SL LD MVQ</p>  <p>81-53246-00  N 2x 22144-38001 35x50 A SL RD FPM</p> 
<p>2,4 G4KE 126-128 kW (171-174 PS) SORENTO II 06/09-12/15</p>	<p>01-10012-01 20910-2G002</p> 	<p>02-10012-01 20920-2G801</p> 			<p>61-10012-00 22311-25212 89,5 Ø MLS</p> 	<p>14-10383-01 22320-25000 (6x) +22321-25001 (2x)</p> 	<p>71-10110-00 22441-26100</p> 	<p>12-10122-01 22224-26000 (16x)</p>  <p>16x</p> <p>70-10122-00 22224-2E000</p> 	<p>71-10116-00   2x 28313-26000</p>  <p>71-10118-00  2x 28314-26000</p>  <p>71-10111-00  28521-25010</p> 	<p>70-31414-10</p> 	<p>81-33489-10  21421-25002 42x55 RD FPM</p>  <p>81-54098-00  21443-26000 85x103 A SL LD FPM</p> 
<p>2,4 G4KE 126-129 kW (172-175 PS) SORENTO III 01/15</p>					<p>61-10012-00 22311-25212 89,5 Ø MLS</p> 	<p>14-10383-01 22320-25000 (6x) +22321-25001 (2x)</p> 	<p>71-10110-00 22441-26100</p> 	<p>12-10122-01 22224-26000 (16x)</p>  <p>16x</p> <p>70-10122-00 22224-2E000</p> 	<p>71-10116-00   2x 28313-26000</p>  <p>71-10118-00  2x 28314-26000</p>  <p>71-10111-00  28521-25010</p> 	<p>70-31414-10</p> 	<p>81-33489-10  21421-25002 42x55 RD FPM</p>  <p>81-54098-00  21443-26000 85x103 A SL LD FPM</p> 

KIA

Ltr.	Motor	Power	Models	Year	Image 1	Image 2	Image 3	Image 4	Image 5	Image 6	Image 7	Image 8	Image 9	Image 10	Image 11	Image 12
2,4	G4KE	126-132 kW (171-180 PS)	CADENZA I CERATO II MAGENTIS II OPTIMA SORENTO II SPORTAGE III	09/08												
2,4	G4KE	132 kW (179 PS)	OPTIMA	01/12												
2,5	D4BH	69 kW (94 PS)	BONGO TDCI K2500 D PREGIO D PREGIO TCI D	08/95												

61-10012-00
22311-25212
89,5 Ø
MLS

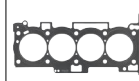

14-10383-01
22320-25000 (8x)
+22321-25001 (2x)



71-10110-00
22441-26100

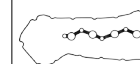

12-10122-01
22224-26000 (16x)

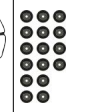

70-10122-00
22224-26000



16x

71-10116-00 2x

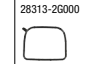

71-10118-00 2x

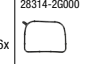

71-10111-00



71-11607-00



70-31414-10



81-33489-10

21421-25002
42x55
RD FPM



81-54098-00

21443-26000
85x103
A SL LD FPM



61-10012-00
22311-25212
89,5 Ø
MLS

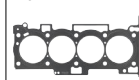

14-10383-01
22320-25000 (8x)
+22321-25001 (2x)

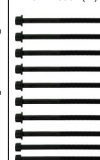

71-10110-00
22441-26100

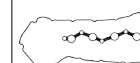

12-10122-01
22224-26000 (16x)

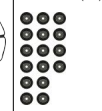

70-10122-00
22224-26000



16x

71-10116-00 2x



71-10118-00 2x



71-11607-00



70-31414-10



81-33489-10

21421-25002
42x55
RD FPM



81-54098-00

21443-26000
85x103
A SL LD FPM



61-52252-10
22311-42515
92,5 Ø
1,45 mm

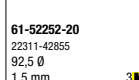

61-52252-20
22311-42855
92,5 Ø
1,5 mm

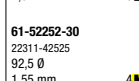

61-52252-30
22311-42525
92,5 Ø
1,55 mm



14-55015-01
22321-32000 (18x)



15-52244-02



12-52906-01

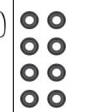

71-53732-00



70-31414-10



81-53279-10

21321-42031
44x60
A SL RD FPM



81-53322-10

21321-42041
80x96
A SL LD FPM







81-53246-00

22144-38001
35x50
A SL RD FPM





KIA

Ltr.  2,5 D4CB 103 kW (140 PS) SORENTO I CRDi 08/02-03/11  1

 **01-53496-01**
K0AH4 10 270A
 ⇒ 04/06





01-10244-01
K0AH6-10270
 ⇒ 05/06→





01-12752-01
 ⇒ 05/06→



 **02-10244-01**
 ⇒ 05/06→





02-12752-01
 ⇒ 05/06→



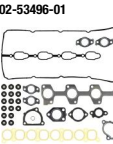

02-53496-01







 **04-10296-01**  ⇒ 05/06→







61-53415-00
22311-4A010
92,35 Ø
0,78 mm
MLS
 ⇒ 04/06

61-53415-10
22311-4A000
92,35 Ø
0,84 mm
MLS
 ⇒ 04/06

61-53415-20
22311-4A020
92,35 Ø
1 mm
MLS
 ⇒ 04/06→



61-10244-00 
22311-4A110
0
MLS
 ⇒ 05/06→



61-10244-10
22311-4A100
1 
MLS
 ⇒ 05/06→

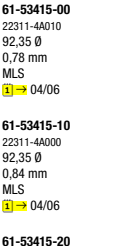

61-10244-20 
22311-4A120
2 
MLS
 ⇒ 05/06→



 **14-55072-01**
22321-4A000 (18x)





61-10244-00 
22311-4A110
0
MLS
 ⇒ 05/06→

61-10244-10
22311-4A100
1 
MLS
 ⇒ 05/06→

61-10244-20 
22311-4A120
2 
MLS
 ⇒ 05/06→

 **71-53496-00**
22441-4A000
 ⇒ 04/06



71-12752-00
22441-4A000
 ⇒ 05/06→



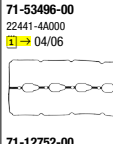

 **12-53499-01**
22224-4A000 (16x)

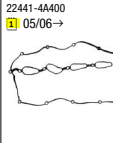

71-53501-00  ⇒ 04/06
28355-4A001





71-53502-00 
28513-4A002





 **70-31414-10**





81-53498-00 
21320-47280
48x62
A SL RD FPM





81-53497-00 
21443-4A001
91x114
A SL LD FPM



 **71-53501-00**  ⇒ 04/06
28355-4A001



71-53502-00 
28513-4A002



 **70-31414-10**



81-53498-00 
21320-47280
48x62
A SL RD FPM



81-53497-00 
21443-4A001
91x114
A SL LD FPM



 **81-53498-00** 
21320-47280
48x62
A SL RD FPM



81-53497-00 
21443-4A001
91x114
A SL LD FPM



2,5 D4CB 103-131 kW (140-178 PS) SORENTO I CRDi 08/05-12/11

 **01-10244-01**
K0AH6-10270



01-12752-01



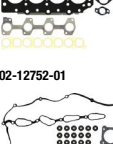

 **02-10244-01**





02-12752-01





 **61-10244-00** 
22311-4A110
0
MLS

61-10244-10
22311-4A100
1 
MLS

61-10244-20 
22311-4A120
2 
MLS

 **14-55072-01**
22321-4A000 (18x)





 **71-12752-00**
22441-4A400





 **12-53499-01**
22224-4A000 (16x)





71-53501-00  ⇒ 04/06
28355-4A001





71-53502-00 
28513-4A002





 **70-31414-10**





81-53498-00 
21320-47280
48x62
A SL RD FPM





81-53497-00 
21443-4A001
91x114
A SL LD FPM



 **71-53501-00**  ⇒ 04/06
28355-4A001



71-53502-00 
28513-4A002



 **70-31414-10**



81-53498-00 
21320-47280
48x62
A SL RD FPM



81-53497-00 
21443-4A001
91x114
A SL LD FPM



 **81-53498-00** 
21320-47280
48x62
A SL RD FPM























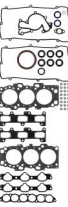

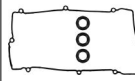

















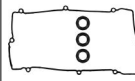







81-53497-00 
21443-4A001
91x114
A SL LD FPM

































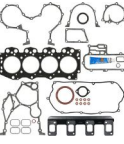
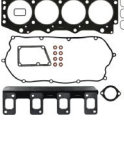

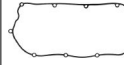













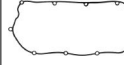



KIA														
Ltr.														
2,5	D4CB	125 kW (170 PS)	12/06-12/11	<p>01-10244-01 K0AH6-10270</p> <p>01-12752-01</p>	<p>02-10244-01</p> <p>02-12752-01</p>	<p>04-10293-01 </p>	<p>61-10244-00 </p> <p>22311-4A110 0 MLS</p> <p>61-10244-10</p> <p>22311-4A100 1 </p> <p>MLS</p> <p>61-10244-20 </p> <p>22311-4A120 2 </p> <p>MLS</p>	<p>14-55072-01</p> <p>22321-4A000 (18x)</p>	<p>71-12752-00</p> <p>22441-4A400</p>	<p>12-53499-01</p> <p>22224-4A000 (16x)</p>	<p>71-53501-00 </p> <p>28355-4A001</p> <p>71-53502-00 </p> <p>28513-4A002</p>	<p>70-31414-10</p>	<p>81-53498-00 </p> <p>21320-47280 48x62 A SL RD FPM</p> <p>81-53497-00 </p> <p>21443-4A001 91x114 A SL LD FPM</p>	
2,5	KRV6 K5	110-129 kW (150-175 PS)	10/01	<p>01-35355-01 OK558 10 2708</p>			<p>61-35355-00 2x</p> <p>22311-3Y200 81 0 MLS</p>	<p>14-55070-01 2x</p> <p>OK9BV 10 135 (8x)</p>	<p>71-35404-00 </p> <p>OK556 10 2F5</p> <p>71-53893-00 </p> <p>OK9BV 10 2F5A</p>	<p>12-35406-01</p> <p>OK9BV 12 123 (24x)</p>	<p>71-35402-00 </p> <p>OK9BV 13 111B 2x</p> <p>71-35403-00 </p> <p>OK55W 13 460 2x</p>	<p>70-31414-10</p>	<p>81-22660-00 </p> <p>32x45 A LD FPM</p> <p>81-90049-00 </p> <p>OK9BV 11 311</p> <p>81-34842-00 </p> <p>OK9BV 10 602A 2x 30x40 A SL RD FPM</p> <p>81-38342-00 </p> <p>OK9BV 10 604 4x 30x40 A SL LD FPM</p>	

























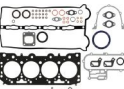

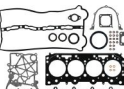

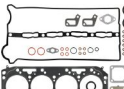

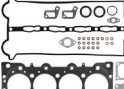

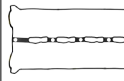



























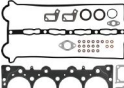

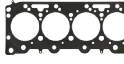
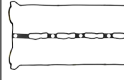

KIA

<p>Ltr.  2,7 G6BA 129 kW (175 PS) SPORTAGE II SPORTAGE II V6</p>	<p> 09/04</p>	<p></p>	<p></p>	<p></p>	<p></p>	<p></p>	<p></p>	<p></p>	<p></p>	<p></p>	<p></p>
<p>2,7 G6BA 129 kW (175 PS) SPORTAGE II SPORTAGE II V6</p>	<p>01-10082-01 K0AD4 10 270</p> 				<p>61-10082-00 L 22311-37310 88,5 Ø MLS</p>  <p>61-10083-00 R 22311-37320 88,5 Ø MLS</p> 		<p>15-10681-01 2x 22441-37110 +22443-23001 (3x)</p> 	<p>12-53678-02 2x 22224-23500 (12x)</p>         <p>70-53678-00 24x 22224-23500</p> 	<p>71-10682-00 L 2x 28411-37200</p>  <p>71-10683-00 2x 28521-37104</p>  <p>70-31414-10</p> 	<p>81-10431-00 X K 21421-35011 37x50 A SL RD FPM</p>  <p>81-53343-00 K 21443-2A200 91x111 A SL LD MVQ</p>  <p>81-53453-00 N 2x 22144-39001 30x42 SL RD MVQ</p>  <p>81-17539-10 N 22144-37101 30x42 A SL LD ACM</p> 	
<p>2,7 G6BA 132 kW (180 PS) MAGENTIS I V6</p>					<p>61-10082-00 L 22311-37310 88,5 Ø MLS</p>  <p>61-10083-00 R 22311-37320 88,5 Ø MLS</p> 		<p>15-10681-01 2x 22441-37110 +22443-23001 (3x)</p> 	<p>12-53678-02 2x 22224-23500 (12x)</p>         <p>70-53678-00 24x 22224-23500</p> 	<p>71-10682-00 L 2x 28411-37200</p>  <p>71-10683-00 2x 28521-37104</p>  <p>70-31414-10</p> 	<p>81-10431-00 X K 21421-35011 37x50 A SL RD FPM</p>  <p>81-53343-00 K 21443-2A200 91x111 A SL LD MVQ</p>  <p>81-53453-00 N 2x 22144-39001 30x42 SL RD MVQ</p>  <p>81-17539-10 N 22144-37101 30x42 A SL LD ACM</p> 	











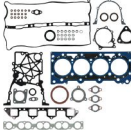
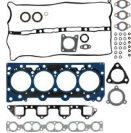



















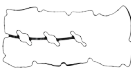























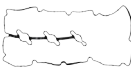







KIA

<p>Ltr.  2,7 G6EA 118-143 kW (160-194 PS)</p> <p> CARENS III CARNIVAL CRDI CARNIVAL II CARNIVAL V6 MAGENTIS II MAGENTIS II V6 OPIRUS</p> <p> 07/04 [NEW]</p>					 <p>61-11371-00 L 22311-3E100 89 0 MLS</p> <p>61-11373-00 R 22311-3E150 89 0 MLS</p>			 <p>12-53678-02 22224-23500 (12x)</p>  <p>70-53678-00 22224-23500</p> 	<p>2x 71-10682-00  2x 28411-37200</p>  <p>71-10683-00  2x 28521-37104</p> 	<p>70-31414-10</p> 	<p>81-10431-00  21421-35011 37x50 A SL RD FPM</p>  <p>81-53343-00  21443-2A200 91x111 A SL LD MVQ</p> 
<p>2,7 J2 59-62 kW (80-84 PS)</p> <p> BONGO D K2700 K2700 D PREGIO D</p> <p>03/97</p>	<p>01-53960-01 OK65A 10 270D</p> 	<p>02-53960-01</p> 			<p>61-53960-00 OK65A 10 271B MLS</p> 	<p>14-55100-01 OVS01 10 137 A (7x) →OK413 10 136 A (11x)</p> 	<p>71-53962-00 OK65A 10 236C</p> 	<p>12-53871-01 OK6A1 10 155 (8x)</p>  <p>70-53871-00 OK6A1 10 155</p> 	<p>4x 71-53963-00  OK72C 13 111A</p>  <p>71-53964-00  OK65A 13 461B</p> 	<p>70-31414-10</p> 	<p>81-53461-00  OVS01 10 602 53x70 A SL RD</p>  <p>81-53966-00  21443-4X000 90x110 A SL LD FPM</p> 
<p>2,7 J2 61 kW (83 PS)</p> <p> K2700 D</p> <p>01/06</p>					<p>61-53960-00 OK65A 10 271B MLS</p> 	<p>14-55100-01 OVS01 10 137 A (7x) →OK413 10 136 A (11x)</p> 	<p>71-53962-00 OK65A 10 236C</p> 	<p>12-53871-01 OK6A1 10 155 (8x)</p>  <p>70-53871-00 OK6A1 10 155</p> 	<p>4x 71-53963-00  OK72C 13 111A</p>  <p>71-53964-00  OK65A 13 461B</p> 	<p>70-31414-10</p> 	<p>81-53461-00  OVS01 10 602 53x70 A SL RD</p>  <p>81-53966-00  21443-4X000 90x110 A SL LD FPM</p> 



KIA

<p>Ltr.   </p>	<p>2,9 J3 93 kW (126 PS) CARNIVAL I TD 08/99-10/01</p>											
<p>2,9 J3 93 kW (126 PS) CARNIVAL I TD 08/99-10/01</p>	<p>01-53370-01 K0AJ1 10 270 1 ⇒ 06/01</p>   <p>01-53370-02 K0AJ1 10 270A 1 ⇒ 07/01→</p>  	<p>02-53370-01 1 ⇒ 06/01</p>   <p>02-53370-02 1 ⇒ 07/01→</p>  			<p>61-53370-00 OK56A 10 271B 100,5 Ø MLS</p> 		<p>71-53466-00 OK551 10 235</p> 	<p>12-53494-01 OK551 10 155 (16x)</p> 	<p>71-53463-00  28355-4X100</p>  <p>71-53464-00  OK551 13 461</p> 	<p>70-31414-10</p> 	<p>81-53426-00  OK551-10602 50x68 A SL RD FPM</p>  <p>81-53342-00  90x110 A SL LD NBR</p>  <p>81-53467-00  QJE26 12 601A 38x52 A SL RD FPM</p> 	
<p>2,9 J3(CRDI) 92 kW (125 PS) K2900 CRDI 01/08</p>					<p>61-36165-00 22311-4X910 MLS</p> 			<p>12-53494-01 OK551 10 155 (16x)</p> 	<p>71-12128-00  28355-4X900</p>  <p>71-12085-00  28521-4X900</p> 	<p>70-31414-10</p> 	<p>81-53426-00  OK551-10602 50x68 A SL RD FPM</p>  <p>81-53966-00  21443-4X000 90x110 A SL LD FPM</p>  <p>81-53467-00  QJE26 12 601A 38x52 A SL RD FPM</p> 	
<p>2,9 J3(CRDI) 106 kW (144 PS) CARNIVAL II CRDI 10/01-06/06</p>	<p>01-53370-02 K0AJ1 10 270A 1 ⇒ 12/05</p>  	<p>02-53370-02 1 ⇒ 12/05</p>  			<p>61-53370-00 OK56A 10 271B 100,5 Ø MLS</p> 		<p>71-53466-00 OK551 10 235</p> 	<p>12-53494-01 OK551 10 155 (16x)</p> 	<p>71-53463-00  28355-4X100</p>  <p>71-53464-00  OK551 13 461</p> 	<p>70-31414-10</p> 	<p>81-53426-00  OK551-10602 50x68 A SL RD FPM</p>  <p>81-53342-00  90x110 A SL LD NBR</p>  <p>81-53467-00  QJE26 12 601A 38x52 A SL RD FPM</p> 	

KIA

Ltr.	Motor	Power	Model	Year	Part 1	Part 2	Part 3	Part 4	Part 5	Part 6	Part 7	Part 8	Part 9	Part 10	Part 11	
2,9	J3(CRDI)	136-141 kW (185-192 PS)	CARNIVAL CARNIVAL CRDI	04/06	01-36165-01 KS272-10270 	02-36165-01 				61-36165-00 22311-4X910 MLS 		71-12127-00 22441-4X900 	12-53494-01 0K551 10 155 (16x) 	71-12128-00  28355-4X900  71-12085-00  28521-4X900 	70-31414-10 	81-53426-00  0K551-10602 50x68 A SL RD FPM  81-53966-00  21443-4X000 90x110 A SL LD FPM  81-53467-00  0JE26 12 601A 38x52 A SL RD FPM 
3,3	G6DB	173-182 kW (235-248 PS)	OPIRUS SORENTO I	10/06					61-10059-00  22311-3CAA0 MLS  61-10060-00  22311-3CAB0 MLS 	14-10597-01 22321-3C100 (16x) 	71-10603-10  22453-3C120  71-10604-00  22441-3C110 	12-10690-01 22224-3CAA0 (24x)  70-10690-00 22224-3CAA0 	71-10599-00  28411-3C612  71-10600-00  28411-3C622  71-10601-00  28521-3C702  71-10602-00  28521-3C712 	70-31414-10 	81-10418-00  21352-3C700 45x62 A SL RD FPM  81-53343-00  21443-2A200 91x111 A SL LD MVQ 	
3,3	G6DB	182 kW (248 PS)	SORENTO I V6	02/07-12/11	01-10059-01 KS665 10 270 				61-10059-00  22311-3CAA0 MLS  61-10060-00  22311-3CAB0 MLS 	14-10597-01 22321-3C100 (16x) 	71-10603-10  22453-3C120  71-10604-00  22441-3C110 	12-10690-01 22224-3CAA0 (24x)  70-10690-00 22224-3CAA0 	71-10599-00  28411-30612  71-10600-00  28411-3C622  71-10601-00  28521-3C702  71-10602-00  28521-3C712 	70-31414-10 	81-10418-00  21352-3C700 45x62 A SL RD FPM  81-53343-00  21443-2A200 91x111 A SL LD MVQ 	

KIA

Ltr.  3,5 G6CU 143 kW (194 PS)  SORENTO I V6  08/02-12/11



01-53620-01

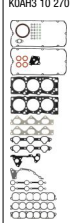

02-53620-01

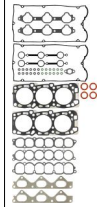

61-53620-00 R
22311-39501
94 Ø
0,5 mm
MLS



61-53625-00 L
22311-39502
94 Ø
0,5 mm
MLS



15-53687-01 2x

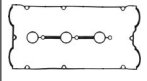

12-52718-04

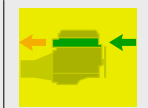
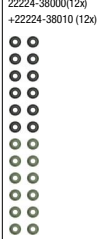

71-53682-00  2x



71-53683-00  2x



71-53684-00  2x



71-53686-00  2x



70-31414-10

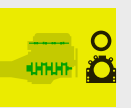

81-53254-00  2x

37x50
A SL RD MVQ



81-53343-00  2x

21443-2A200
91x111
A SL LD MVQ



81-53453-00  4x

22144-39001
30x42
SL RD MVQ



Haftungsausschluss

(für Katalog)

Alle Angaben in unserem Katalog wurden von uns sorgfältig geprüft, sind jedoch unverbindlich. Ersatzansprüche wegen Katalogangaben werden von uns nicht anerkannt. Der Käufer ist selbst verpflichtet, zu prüfen, ob unsere Teile für seine Zwecke geeignet sind. In allen Zweifelsfällen sollte Rücksprache mit unserem technischen Kundendienst erfolgen **Tel. +49 731 7046 999**.

Technische Weiterentwicklungen oder Änderungen bleiben vorbehalten, soweit damit keine Nachteile für den Kunden verbunden sind.

Angaben, Namens- und Markenzeichen, Beschreibungen, Nummern von Fahrzeugnummern und Herstellerzeichen, Original-Ersatzteilnummern der Fahrzeug- und Motorenhersteller u. a. sind ausschließlich für interne Zwecke gedacht. Solche Kennzeichnungen dürfen Fahrzeugbesitzern gegenüber nicht verwendet werden.

Wir weisen ausdrücklich darauf hin, dass alle von uns gelieferten Teile von geschultem Fachpersonal einzubauen sind. Reinz haftet für Fehler in diesem Katalog nur, wenn diese für den Kunden nicht offenbar erkennbar sind sowie nur bei Vorsatz und grober Fahrlässigkeit von Reinz, eines Vertreters oder eines Erfüllungsgehilfen. Dieser Haftungsausschluss gilt nicht im Rahmen

des Anwendungsbereichs des Produkthaftungsgesetzes und nicht bei Verletzung von Körper, Leben und Gesundheit, sowie bei der Verletzung von sog. Kardinalpflichten. Darüber hinaus ist unsere Haftung für Schäden, insbesondere für Personen-, Sach- oder Vermögensschäden, die unmittelbar oder mittelbar im Zusammenhang mit der Nutzung dieses Kataloges auftreten, sowie für nicht voraussehbare Schäden ausgeschlossen.

Reinz ist Inhaber aller Schutzrechte an den in diesem Katalog gespeicherten Daten. Kopie, Nachdruck, ganze oder teilweise Übernahme der Inhalte und Vervielfältigung, auch auszugsweise, ist nur mit unserer vorheriger schriftlicher Zustimmung sowie mit unserem Urheberrechtsvermerk zulässig.

Für Bestellungen, welche ab dem Erscheinungsdatum eines neuen Katalogs getätigt werden, sind alleine die Angaben des neuen Katalogs maßgeblich. Auf Angaben im Vorkatalog kann bei Neubestellungen nicht mehr zurückgegriffen werden.

Sofern Sie noch Fragen haben, bitten wir Sie, sich mit uns in Verbindung zu setzen.

VictorReinz.com/AGB

Exclusion of Liability

(for catalog)

All details in our catalog have been thoroughly checked by us but are however not binding. Right to damages on account of catalog details will not be recognized. The purchaser is obliged to check if our parts are suitable for their use. In all doubtful cases, the purchaser should consult our technical customer service under **+49 731 7046 999**.

We reserve the right to further technical developments or changes as long as no disadvantage for the customer results.

Details, name and trademarks, descriptions, numbers from vehicle numbers and manufacturer symbols, original vehicle replacement part numbers and engine manufacturer etc. are solely for internal use. Such labels must not be used with vehicle owners.

We specifically point out that all parts supplied by us must be assembled by trained specialists.

Reinz is liable for mistakes in this catalog only when they are not clearly recognizable for the customer, as well as by intent or gross negligence on the part of Reinz, its representative or vicarious agent. This exclusion of liability does not apply within the framework of the field of

application of the product liability laws and not by bodily harm, life and health, as well as by violation of cardinal duties. In addition, our liability for damages, especially personal, property or financial damages that occur directly or indirectly as a result of the use of this catalog, as well as non-foreseeable damages are excluded.

Reinz is the owner of all patent rights on the data stored in this catalog. Copies, reprints, whole or partial takeover of the contents and duplication even in excerpts are only permissible with our prior written approval, as well as with our copyright note.

For orders placed after the publication date of a new catalog, only the details in the new catalog are binding and no fall back to details in the previous catalog is possible.

In case you have further questions, do not hesitate to contact us.

VictorReinz.com/AGB

VictorReinz.com

reinz.info@dana.com

Technical Hotline +49 (0)731 7046-9 99

REINZ-Dichtungs-GmbH

Reinzstrasse 3-7
89233 Neu-Ulm
Germany
+49 (0)731 7046-0

VICTOR REINZ[®]

