

**VICTOR REINZ®**

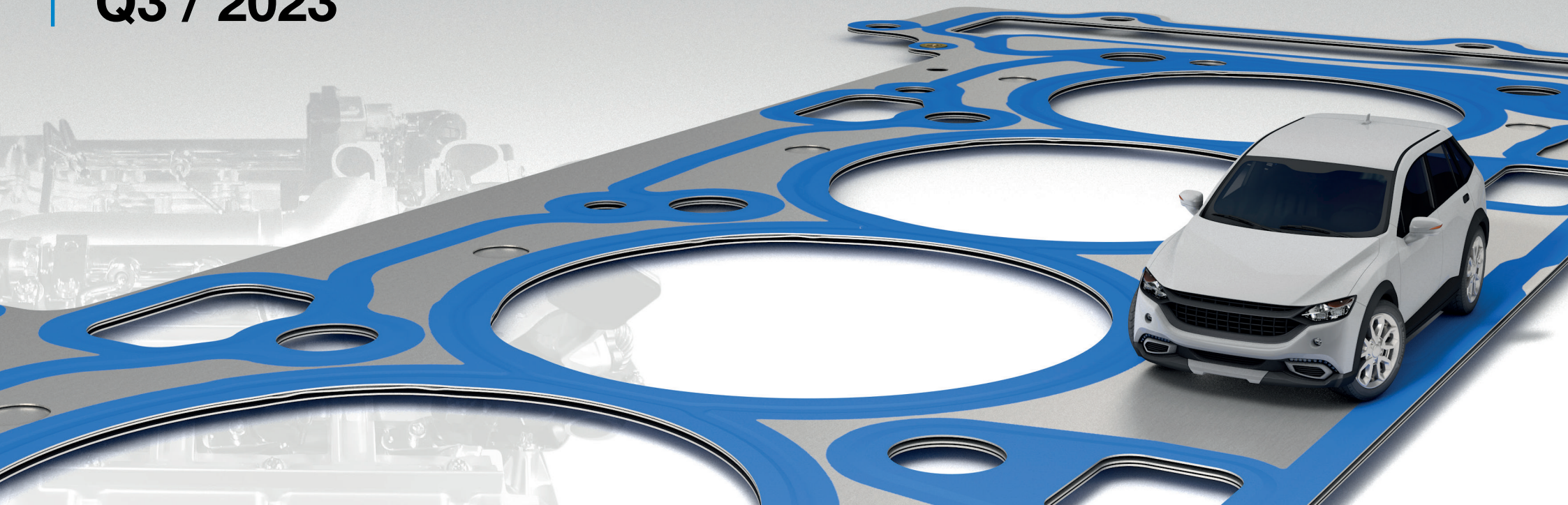

**LAND ROVER  
Q3 / 2023**



**[VictorReinz.com/online-catalog](https://VictorReinz.com/online-catalog)**

# Victor Reinz®

at a Glance



## Online Catalog

[VictorReinz.com/online-catalog](https://VictorReinz.com/online-catalog)



## Newsletter

[VictorReinz.com/EN/News/Newsletter.aspx?region](https://VictorReinz.com/EN/News/Newsletter.aspx?region)



## Youtube

[www.youtube.com/user/VictorReinzSealingEN](https://www.youtube.com/user/VictorReinzSealingEN)



## Catalog News

[VictorReinz.com/news](https://VictorReinz.com/news)



## Technical Service Information

[VictorReinz.com/tsi](https://VictorReinz.com/tsi)



## Facebook

[www.facebook.com/VictorReinzParts](https://www.facebook.com/VictorReinzParts)



## Just seal it!

[VictorReinz.com/jsi](https://VictorReinz.com/jsi)



## Technical Datasheet

[VictorReinz.com/jsi-datasheet](https://VictorReinz.com/jsi-datasheet)



## LinkedIn

[www.linkedin.com/showcase/victor-reinz-emea](https://www.linkedin.com/showcase/victor-reinz-emea)



## Safety Datasheet

[VictorReinz.com/jsi-datasheet](https://VictorReinz.com/jsi-datasheet)



## Homepage

[VictorReinz.com](https://VictorReinz.com)



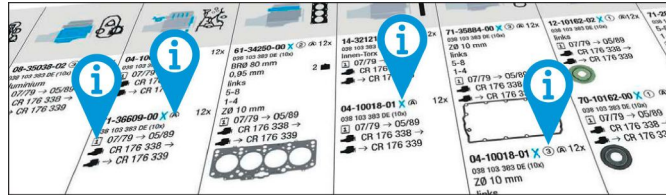

[VictorReinz.com/catalog-info](https://www.victorreinz.com/catalog-info)

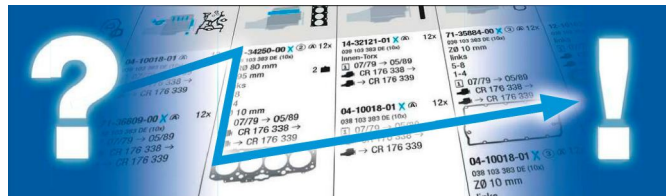

[VictorReinz.com/catalog-how-to-use](https://www.victorreinz.com/catalog-how-to-use)

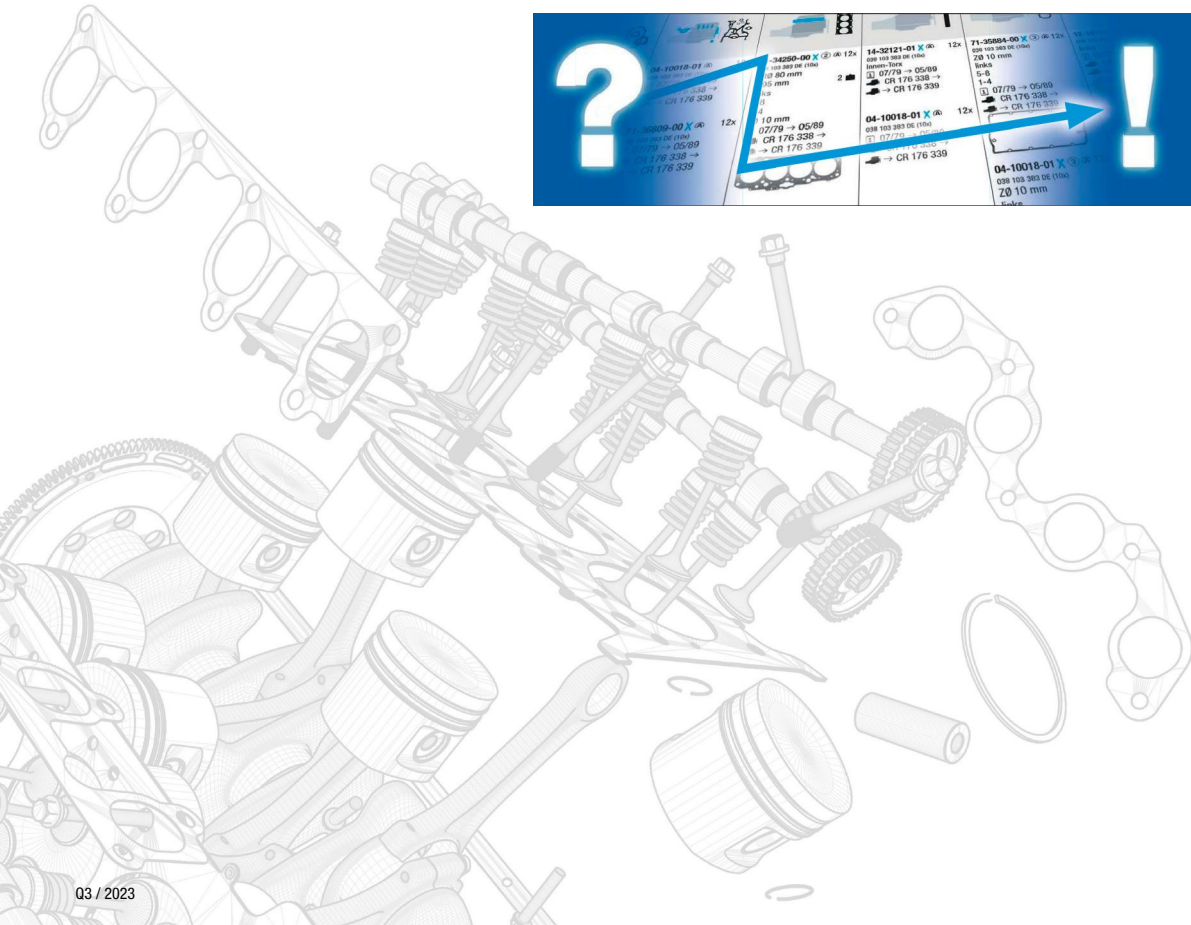

# LAND ROVER



**0-9**

- 11 A ..... 12
- 11 L ..... 13
- 12 L ..... 13
- 14 L ..... 13
- 16 L ..... 14
- 17 L ..... 14
- 18 K4F ..... 5
- 19 L ..... 14
- 20 T2N ..... 7
- 204D3 ..... 7, 10
- 204DT ..... 8
- 204DTA ..... 8-9
- 204DTD ..... 6
- 204DTY ..... 9
- 204PT ..... 10
- 21 L ..... 14
- 22 D ..... 20
- 22 L ..... 14
- 224DT ..... 11-12
- 23 L ..... 14
- 25 6T (BMW) ..... 15
- 25 K4F ..... 15
- 276DT ..... 16-17
- 306D1 ..... 18
- 306DT ..... 18
- 306PS ..... 18-20
- 30DDTX ..... 18
- 35 D ..... 22, 24-25
- 36 D ..... 22, 25
- 368DT ..... 21
- 37 D ..... 23
- 37 L ..... 23, 25
- 38 D ..... 23
- 40 D ..... 26
- 406PN ..... 26
- 42 D ..... 24, 26
- 428PS ..... 26
- 448DT ..... 27
- 448PN ..... 27
- 46 D ..... 28
- 508PN ..... 28
- 508PS ..... 28



**A**

- AJ200D ..... 6
- AJ20D4 ..... 5
- AJ20D6 ..... 17
- AJ21D4 ..... 6

**B**

- B 6324 S ..... 20

**D**

- DT224 ..... 10
- DT244 ..... 12
- DW12BTED4 ..... 11















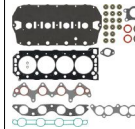





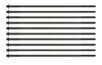





















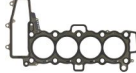

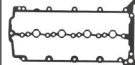

**M**

- M 47 ..... 7
- M 47 R ..... 7
- M52 B28 ..... 17
- M62 B44 ..... 27

















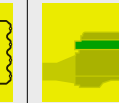
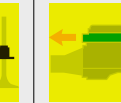
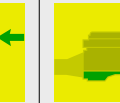











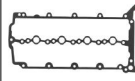
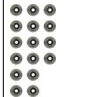













**P**

- PT204 ..... 7

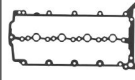
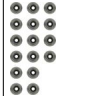

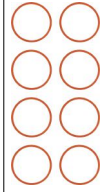





















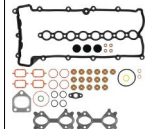
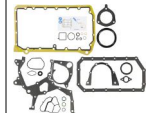





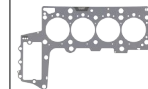
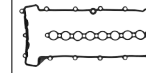



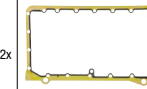





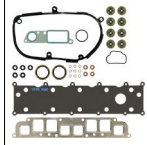

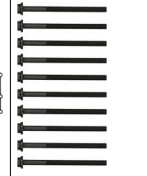

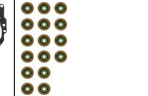









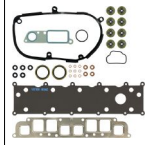



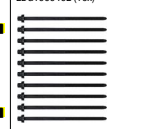

LAND ROVER

<p>Ltr.  18 K4F 86-88 kW (117-120 PS) FREELANDER FREELANDER 16V  02/98-10/06</p>		 <p>02-34835-04</p> 	 <p>08-36343-01</p> 		 <p>61-34835-20 LV8500190 MLS</p> 	 <p>14-32100-01 WAN2293L (10x)</p> 	 <p>71-34837-00 LVP100630L</p> 	 <p>12-34836-01 LUB100350L (16x)</p> 	 <p>71-34838-00 </p>  <p>71-34841-00 </p>  <p>71-34839-00 </p> <p>LKG100551</p> 		 <p>81-34842-00 </p> <p>30x40 A SL RD FPM</p>  <p>81-38342-00 </p> <p>LUC100220L 30x40 A SL LD FPM</p> 
<p>2,0 AJ20D4 120-150 kW (163-204 PS) RANGE ROVER EVOQUE D RANGE ROVER VELAR 07/20</p>					<p>61-10299-00 LR073638 84 Ø 1,3 mm MLS </p> <p>61-10299-10 LR073639 84 Ø 1,4 mm MLS </p> <p>61-10299-20 LR073640 84 Ø 1,5 mm MLS </p> <p>61-10299-30 LR073641 84 Ø 1,6 mm MLS </p> <p>61-10299-40 LR073642 84 Ø 1,7 mm MLS </p> 	<p>14-13249-01 LR073643 (10x)</p> 	<p>71-13233-00 LR073784</p> 	<p>12-13246-01 LR073776 (16x)</p>  <p>70-13246-00 LR073776 16x</p> 	<p>11-77637-01 </p> <p>LR074070 (8x)</p>     <p>71-13214-00 </p> <p>LR073658</p> 	<p>70-31414-10</p> 	<p>81-10505-00 </p> <p>LR084639 92x109 AB SL LD PTFE ACM</p> 

LAND ROVER



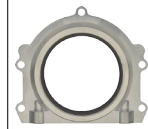







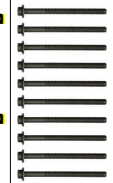
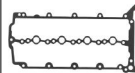

LAND ROVER														
Ltr. 														
2,0 AJ200D 204DTD	110-132 kW (150-180 PS)	12/14	DISCOVERY eD4 DISCOVERY eD4 DISCOVERY SPORT DISCOVERY SPORT D DISCOVERY SPORT D DISCOVERY Td4 DISCOVERY Td4 DISCOVERY V D DISCOVERY V D RANGE ROVER VELAR D RANGE ROVER VELAR D					<p><b>61-10299-00</b> LR073638 84 Ø 1,3 mm MLS </p> <p><b>61-10299-10</b> LR073639 84 Ø 1,4 mm MLS </p> <p><b>61-10299-20</b> LR073640 84 Ø 1,5 mm MLS </p> <p><b>61-10299-30</b> LR073641 84 Ø 1,6 mm MLS </p> <p><b>61-10299-40</b> LR073642 84 Ø 1,7 mm MLS </p> 	<p><b>14-13249-01</b> LR073643 (10x)</p> 	<p><b>71-13233-00</b> LR073784</p> 	<p><b>12-13246-01</b> LR073776 (16x)</p>  <p><b>70-13246-00</b> LR073776 16x</p> 	<p><b>11-77637-01</b> </p> <p>LR074070 (8x)</p>  <p><b>71-13214-00</b> </p> <p>LR073658</p> 	<p><b>70-31414-10</b></p> 	<p><b>81-10503-00</b> </p> <p>LR093852 PTFE</p>  <p><b>81-10505-00</b> </p> <p>LR084639 92x109 AB SL LD PTFE ACM</p> 
2,0 AJ21D4	120 kW (163 PS)	07/20	RANGE ROVER EVOQUE D					<p><b>61-10299-00</b> LR073638 84 Ø 1,3 mm MLS </p> <p><b>61-10299-10</b> LR073639 84 Ø 1,4 mm MLS </p> <p><b>61-10299-20</b> LR073640 84 Ø 1,5 mm MLS </p> <p><b>61-10299-30</b> LR073641 84 Ø 1,6 mm MLS </p> <p><b>61-10299-40</b> LR073642 84 Ø 1,7 mm MLS </p> 	<p><b>14-13249-01</b> LR073643 (10x)</p> 	<p><b>71-13233-00</b> LR073784</p> 	<p><b>12-13246-01</b> LR073776 (16x)</p>  <p><b>70-13246-00</b> LR073776 16x</p> 	<p><b>11-77637-01</b> </p> <p>LR074070 (8x)</p> 	<p><b>70-31414-10</b></p> 	<p><b>81-10396-00</b> </p> <p>LR122697 92x109 LD Gummi</p> 

LAND ROVER

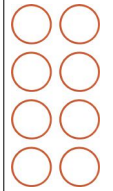

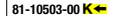

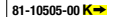

<p>Ltr.   </p>	<p>2,0 M 47 M 47 R 204D3</p> <p>80-85 kW (109-116 PS)</p> <p>FREELANDER Td4</p> <p>10/00</p>												
<p>2,0 PT204</p> <p>147-297 kW (200-404 PS)</p> <p>DEFENDER DISCOVERY SPORT DISCOVERY V RANGE ROVER EVOQUE RANGE ROVER IV RANGE ROVER SPORT RANGE ROVER VELAR</p> <p>03/17</p>	<p>02-40452-01</p> 	<p>08-36219-01 LVQ101240L</p> 	<p>04-10029-01 </p> 	<p>61-36455-00 LVB101820L 1,45 mm MLS  1</p> <p>61-36455-10 LVB101830L 1,55 mm MLS  2</p> <p>61-36455-20 LVB000100L 1,65 mm MLS  3</p> 	<p>71-40452-00 LVP100620L</p> 	<p>12-35172-01 LGP100310L</p> 	<p>71-33109-10  4x LKJ101120L</p> <p>71-33027-00  2x LR020102</p> 	<p>71-36219-00 LVF100420L</p> 	<p>71-37004-00 LVF100430L</p> 	<p>81-37002-00 </p> <p>LUF100530L 55x68 AB RD PTFE</p> 	<p>81-20745-00 </p> <p>LUF100540L 90x110 AB SL LD PTFE (Polytetrafluorethylen)/ACM (Polyacryl-Kautschuk)</p> 		
<p>2,0 20 T2N</p> <p>72 kW (98 PS)</p> <p>FREELANDER DI</p> <p>02/98-10/06</p>	<p>01-35496-01</p> 	<p>02-35496-02</p> 			<p>61-10765-00 LR0 91486 84 Ø 1,05 mm MLS</p> 	<p>14-17603-01 LR0 91487 (10x)</p> 	<p>71-10259-00 </p> <p>LR106297</p> 	<p>12-17787-01 LR1 16489 (16x)</p> 	<p>71-17585-00  4x LR0 91766</p> 	<p>70-17787-00 LR1 16489</p> 	<p>71-31414-10</p> 	<p>81-10503-00 </p> <p>PTFE</p> 	<p>81-10505-00 </p> <p>LR094639 92x109 AB SL LD PTFE ACM</p> 
<p>2,0 20 T2N</p> <p>72 kW (98 PS)</p> <p>FREELANDER DI</p> <p>02/98-10/06</p>	<p>01-35496-01</p> 	<p>02-35496-02</p> 			<p>61-35360-00 LVB100910 85,5 Ø 1,05 mm  1</p> <p>61-35360-10 LVB100920 85,5 Ø 1,2 mm  2</p> <p>61-35360-20 LVB100930 85,5 Ø 1,35 mm  3</p> 	<p>14-32007-01 LDG100040L (10x)</p> 	<p>71-35496-00 LVP100400</p> 	<p>12-35493-01 LJQ100680L (6x)</p> 	<p>71-35492-00   4x LKJ100790</p> 	<p>71-35495-00 ERR7029</p> 	<p>81-35497-00 </p> <p>WZX1915 35x45 A SL RD FPM</p> 	<p>81-90028-00 </p> <p>LUF100420 LD</p> 	<p>81-15999-30  2x 40x52 B OD NBR</p> 

LAND ROVER

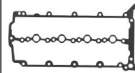
Ltr.  2,0 204DT 147-177 kW (200-241 PS) DEFENDER SD4  09/19 

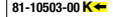

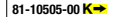
				<p><b>61-10299-00</b> LR073638 84 Ø 1,3 mm MLS</p> <p><b>61-10299-10</b> LR073639 84 Ø 1,4 mm MLS</p> <p><b>61-10299-20</b> LR073640 84 Ø 1,5 mm MLS</p> <p><b>61-10299-30</b> LR073641 84 Ø 1,6 mm MLS</p> <p><b>61-10299-40</b> LR073642 84 Ø 1,7 mm MLS</p> 	<p><b>14-13249-01</b> LR073643 (10x)</p> 	<p><b>71-13233-00</b> LR073784</p> 	<p><b>12-13246-01</b> LR073776 (16x)</p> <p><b>70-13246-00</b> LR073776  01/22→</p>	<p><b>11-77637-01</b> </p> <p>LR074070 (8x)</p> 	<p><b>70-31414-10</b></p> 	<p><b>81-10503-00</b> </p> <p>LR093852 PTFE</p>  <p><b>81-10505-00</b> </p> <p>LR084639 92x109 AB SL LD PTFE ACM</p> 
--	--	---	--	--	--	--	--	--	---	---





















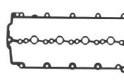

2,0 204DTA 177 kW (241 PS) DEFENDER SD4 DISCOVERY SD4 DISCOVERY SPORT DISCOVERY V 06/15

				<p><b>61-10299-00</b> LR073638 84 Ø 1,3 mm MLS</p> <p><b>61-10299-10</b> LR073639 84 Ø 1,4 mm MLS</p> <p><b>61-10299-20</b> LR073640 84 Ø 1,5 mm MLS</p> <p><b>61-10299-30</b> LR073641 84 Ø 1,6 mm MLS</p> <p><b>61-10299-40</b> LR073642 84 Ø 1,7 mm MLS</p> 		<p><b>71-13233-00</b> LR073784</p> 	<p><b>70-13246-00</b> 16x LR073776</p> 		<p><b>70-31414-10</b></p> 	<p><b>81-10503-00</b> </p> <p>LR093852 PTFE</p>  <p><b>81-10505-00</b> </p> <p>LR084639 92x109 AB SL LD PTFE ACM</p> 
--	--	--	--	--	--	--	--	--	---	--

















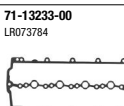
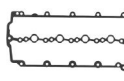

LAND ROVER

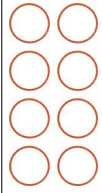
Ltr.  2,0 204DTA 177 kW (241 PS) DISCOVERY SPORT D  08/17



				<p><b>61-10299-00</b> LR073638 84 Ø 1,3 mm MLS </p> <p><b>61-10299-10</b> LR073639 84 Ø 1,4 mm MLS </p> <p><b>61-10299-20</b> LR073640 84 Ø 1,5 mm MLS </p> <p><b>61-10299-30</b> LR073641 84 Ø 1,6 mm MLS </p> <p><b>61-10299-40</b> LR073642 84 Ø 1,7 mm MLS </p> 			<p><b>71-13233-00</b> LR073784</p> 	<p><b>12-13246-01</b> LR073776 (16x)</p> 	<p><b>70-13246-00</b> LR073776</p> 	<p><b>11-77637-01</b> </p> <p>LR074070 (8x)</p> 	<p><b>70-31414-10</b></p> 	<p><b>81-10503-00</b> </p> <p>LR093852 PTFE</p>  <p><b>81-10505-00</b> </p> <p>LR084639 92x109 AB SL LD PTFE ACM</p> 
--	--	--	--	--	--	--	--	--	--	--	---	---

2,0 204DTY 120-150 kW (163-204 PS) DISCOVERY SPORT RANGE ROVER VELAR 07/20

				<p><b>61-10299-00</b> LR073638 84 Ø 1,3 mm MLS </p> <p><b>61-10299-10</b> LR073639 84 Ø 1,4 mm MLS </p> <p><b>61-10299-20</b> LR073640 84 Ø 1,5 mm MLS </p> <p><b>61-10299-30</b> LR073641 84 Ø 1,6 mm MLS </p> <p><b>61-10299-40</b> LR073642 84 Ø 1,7 mm MLS </p> 	<p><b>14-13249-01</b> LR073643 (10x)</p> 		<p><b>71-13233-00</b> LR073784</p> 	<p><b>12-13246-01</b> LR073776 (16x)</p> 	<p><b>70-13246-00</b> LR073776</p> 	<p><b>11-77637-01</b> </p> <p>LR074070 (8x)</p> 	<p><b>71-13214-00</b> </p> <p>LR073658</p> 	<p><b>70-31414-10</b></p> 	<p><b>81-10503-00</b> </p> <p>LR093852 PTFE</p> 
--	--	--	--	--	--	---	--	--	---	---	---	---	--

LAND ROVER														
Ltr.														
2,0	204D3	82 kW (112 PS)	FREELANDER Td4	11/00-10/06										
					02-40452-01 	08-36219-01 LVQ101240L 	04-10029-01 (H) 	61-36455-00 LVB101820L 1,45 mm MLS  1  61-36455-10 LVB101830L 1,55 mm MLS  2  61-36455-20 LV8000100L 1,65 mm MLS  3	71-40452-00 LVP100620L 	12-35172-01 LGP100310L 	71-33109-10 (K) 4x LKJ101120L   71-77546-00 (K) 4x LKJ101130L   71-33027-00 (H) 2x LR020102   71-37037-00 (H) (H) WCM100480 	71-36219-00 LVF100420L   71-37004-00 LVF100430L 	81-37002-00 (K) (K) LUF100530L 55x68 AB RD PTFE   81-20745-00 (K) (K) LUF100540L 90x110 AB SL LD PTFE (Polytetrafluorethylen)/ACM (Polyacryl-Kautschuk) 	
2,0	204PT	176-179 kW (240-243 PS)	DISCOVERY SPORT FREELANDER 2 RANGE ROVER EVOQUE RANGE ROVER SPORT	06/11	01-36290-02 	02-36290-02 		61-36290-00 LR024975 MLS 	14-32207-01 LR0 97980 (10X) 	15-42391-01 LR025664 	12-35546-01 LR025006 (8x) +LR025018 (8x) 	15-40257-01 (K) (K) LR024991 (4x)   71-40262-00 (H) (H) LR025852 	70-31414-10 	81-42449-00 (K) (K) LR0 25013 37x60 A SL RD FPM   81-90012-00 (K) (K) LR0 25670 PTFE 
2,2	DT224	90-110 kW (122-150 PS)	DEFENDER Td4	08/11-02/16		02-42374-02 	08-35536-03 	61-43175-00 LR029712 1,1 mm MLS  1  61-43175-10 LR029713 1,15 mm MLS  2  61-43175-20 LR029714 1,2 mm MLS  3	14-32341-01 LR022163 (10X) +LR004370 (8X) 	71-42374-00 LR058092 	12-35549-01 LR005901 (16x)   70-35549-00 LR005901 16x	71-35539-00 (K) (K) 8x LR018370   71-33894-00 (H) (H) LR004393 	15-35536-01 LR006957   70-31414-10 	81-90014-00 (K) (K) LR029318 PTFE   81-90013-00 (K) (K) LR020609 PTFE 

**LAND ROVER**

Ltr.   

2.2 DW12BTEd4 110-118 kW (150-160 PS) FREELANDER 2 D  
FREELANDER 2 Td4 10/06-10/14

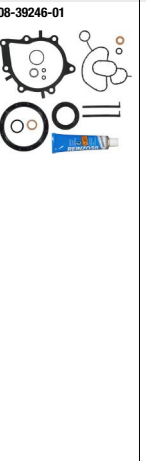
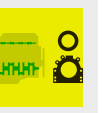
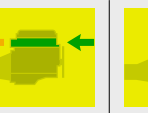
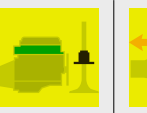

61-35805-00  
LR017303  
85,9 Ø  
1,25 mm  
MLS

61-35805-10  
LR017304  
85,9 Ø  
1,3 mm  
MLS

61-35805-20  
LR017305  
85,9 Ø  
1,35 mm  
MLS

61-35805-30  
LR017307  
85,9 Ø  
1,4 mm  
MLS

14-35774-01  
LR001222 (10x)

15-38554-01  
LR009411  
+LR009412 (2x)  
+LR002834

12-38539-01  
LR001242 (16x)

70-38539-00  
LR001242

16x

11-38553-01 

LR005364

71-42393-00 

LR022333

70-31414-10

81-36557-00 

LR000673  
42x62  
A SL RD PTFE

81-36556-00 

LR000674  
90x110  
A SL LD PTFE

81-34144-00 

LR000659  
27x47  
A SL RD FPM

2.2 224DT 110-140 kW (150-190 PS) DISCOVERY SPORT D  
FREELANDER TD4  
FREELANDER 2 D  
FREELANDER 2 Td4  
RANGE ROVER EVOQUE D  
RANGE ROVER EVOQUE SD4  
RANGE ROVER EVOQUE TD 10/06

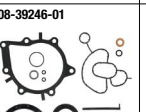
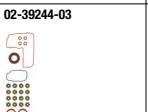

61-35805-00  
LR017303  
85,9 Ø  
1,25 mm  
MLS

61-35805-10  
LR017304  
85,9 Ø  
1,3 mm  
MLS

61-35805-20  
LR017305  
85,9 Ø  
1,35 mm  
MLS

61-35805-30  
LR017307  
85,9 Ø  
1,4 mm  
MLS

14-35774-01  
LR001222 (10x)

15-38554-01  
LR009411  
+LR009412 (2x)  
+LR002834

12-38539-01  
LR001242 (16x)

70-38539-00  
LR001242

16x

11-38553-01 

LR005364

71-42393-00 

LR022333

70-31414-10

81-36557-00 

LR000673  
42x62  
A SL RD PTFE

81-36556-00 

LR000674  
90x110  
A SL LD PTFE

81-34144-00 

LR000659  
27x47  
A SL RD FPM

LAND ROVER															
Ltr.															
2,2	224DT	118 kW (160 PS)	FREELANDER 2 Td4	10/06-10/14											
					02-39244-03 	08-39246-01 			61-35805-00 LR017303 85,9 Ø 1,25 mm MLS 1	14-35774-01 LR001222 (10x) 	15-38554-01 LR009411 +LR009412 (2x) +LR002834 	12-38539-01 LR001242 (16x) 	11-38553-01 LR005364 	70-31414-10 	81-36557-00 LR000673 42x62 A SL RD PTFE 
									61-35805-10 LR017304 85,9 Ø 1,3 mm MLS 2			70-38539-00 LR001242 16x 	71-35919-00 LR001315 		81-36556-00 LR000674 90x110 A SL LD PTFE 
									61-35805-20 LR017305 85,9 Ø 1,35 mm MLS 3						81-34144-00 LR000659 27x47 A SL RD FPM 
									61-35805-30 LR017307 85,9 Ø 1,4 mm MLS 4						
2,4	DT244	90-103 kW (122-140 PS)	DEFENDER Td4	10/06-05/16	01-33758-01 	02-33758-05 			61-35420-00 LR004418 91 Ø 1,1 mm MLS 1	14-32204-01 LR004369 (10x) +LR004370 (8x) 	71-33758-00 LR004440 	12-35549-01 LR005901 (16x) 	71-35539-00 LR018370 	15-35536-01 LR006957 	81-90014-00 LR029318 PTFE 
									61-35420-10 LR004419 91 Ø 1,15 mm MLS 2			70-35549-00 LR005901 16x 	71-33894-00 LR004393 	70-31414-10 	81-90013-00 LR020609 PTFE 
									61-35420-20 LR004420 91 Ø 1,2 mm MLS 3						
2,4	11 A	78-89 kW (106-121 PS)	RANGE ROVER TD	10/85-07/94	02-35484-01 60732780 				61-35410-00 BAU5094 98,5 Ø 1,42 mm		71-35827-00 		71-35481-00 60583742 4x		
									61-35410-10 BAU5093 98,5 Ø 1,52 mm				71-35482-00 60732810 4x		
									61-35410-20 BAU5092 98,5 Ø 1,62 mm						



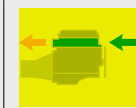

LAND ROVER

Ltr.  2,5 11 L 83-85 kW (113-116 PS) DEFENDER TD DEFENDER TDI DISCOVERY TDI RANGE ROVER TD  10/89-12/05



**61-34465-00**  
ERR5261  
92 Ø  
1,3 mm 

**61-34465-10**  
ERR5262  
92 Ø  
1,4 mm 

**61-34465-20**  
ERR5263  
92 Ø  
1,5 mm 

**61-34465-30**  
ERR7154  
92 Ø  
1,6 mm 



**61-36655-00**  
LV8500200  
92 Ø  
1,3 mm  
MLS

**61-36655-10**  
LV8500210  
92 Ø  
1,4 mm  
MLS

**61-36655-20**  
LV8500220  
92 Ø  
1,5 mm  
MLS

**61-36655-30**  
LV8500230  
92 Ø  
1,6 mm  
MLS



**71-35518-00**  
ERR2393



**70-34914-00** 8x





**71-35517-00**   

ERR1208



LAND ROVER

Ltr.  2,5 16 L 81-90 kW (110-122 PS) DEFENDER TD DEFENDER TDI DISCOVERY D DISCOVERY TDI RANGE ROVER TD 10/89-12/05 

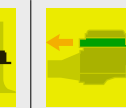

**61-34465-00**  
ERR5261  
92 Ø  
1,3 mm 

**61-34465-10**  
ERR5262  
92 Ø  
1,4 mm 

**61-34465-20**  
ERR5263  
92 Ø  
1,5 mm 

**61-34465-30**  
ERR7154  
92 Ø  
1,6 mm 

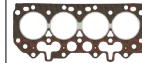

**61-36655-00**  
LV8500200  
92 Ø  
1,3 mm  
MLS

**61-36655-10**  
LV8500210  
92 Ø  
1,4 mm  
MLS



**61-36655-20**  
LV8500220  
92 Ø  
1,5 mm  
MLS

**61-36655-30**  
LV8500230  
92 Ø  
1,6 mm  
MLS



**71-35511-00**  
ERR2409





















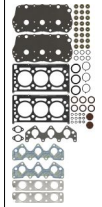

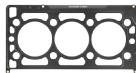





**71-35509-00**   















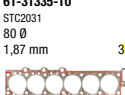
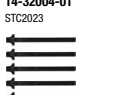



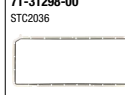

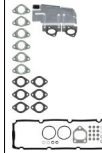
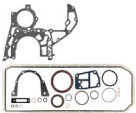





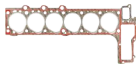





**LAND ROVER**

Ltr.  2,5 25 K4F 130 kW (177 PS)  FREELANDER  1 11/00-10/06



















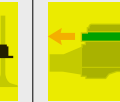
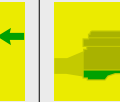
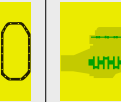
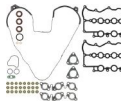
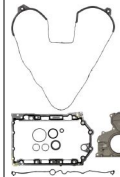

										
	02-35355-02 	08-35408-01 		61-35355-00 2x LVB101630L 81 Ø MLS 	14-55070-01 2x 	71-39082-00 2x LVP100470L 	12-35406-01 LUB100350L (24x) 	71-39081-00  2x LKJ100992L  71-35403-00  2x LKG100290L 	70-31414-10 	81-38343-00  LOX100070L 32x45 A RD MVQ  81-90049-00  LUF100300L  81-34842-00 <b>N</b> 2x 30x40 A SL RD FPM  81-38342-00 <b>N</b> 4x LUC100220L 30x40 A SL LD FPM 

2,5 25 6T (BMW) 100 kW (136 PS) RANGE ROVER D 07/94-03/02

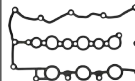









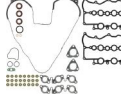



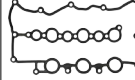

										
	02-31296-02 STC2033 	08-31298-02 STC2012 	04-10014-01    	61-31335-10 STC2031 80 Ø 1,87 mm  	14-32004-01 STC2023 	70-31306-00 12x LDY000060 	71-29398-10  6x STC2203  71-29396-00  4x STC3697  71-29399-00  STC3696 	71-31298-00 STC2036 	81-17404-50  1275466 48x65 AB SL RD FPM  81-20745-40  2245364 90x110 A SL LD FPM 	

LAND ROVER

Ltr.  2,7 276DT 140 kW (190 PS) DISCOVERY TD 07/04-09/09 

										
	02-38558-03 	08-38527-03 		61-34875-10 2x LR009719 82,5 Ø 1,17 mm MLS  2x 61-34875-20 2x LR009721 82,5 Ø 1,22 mm MLS  3x 61-34875-30 2x LR009722 82,5 Ø 1,27 mm MLS  4x 61-34875-40 2x LR009723 82,5 Ø 1,32 mm MLS  5x 	14-32344-01 2x 1331316 (8x) 	71-38558-00 2x LR029132 	12-38546-01 24x 1311285 (24x) 	71-34888-00 2x 1336543 	71-17236-00 136 5260 	81-34316-00 K↔ 1102415 35x50 A SL RD PTFE ACM  81-90050-00 K↔ LR036542  81-38536-00 N 3x 1311318 26x45 A SL WD FPM 

2,7 276DT 140 kW (190 PS) RANGE ROVER D 02/05-03/13

	02-38558-03 	08-38527-03 		61-34875-10 2x LR009719 82,5 Ø 1,17 mm MLS  2x 61-34875-20 2x LR009721 82,5 Ø 1,22 mm MLS  3x 61-34875-30 2x LR009722 82,5 Ø 1,27 mm MLS  4x 61-34875-40 2x LR009723 82,5 Ø 1,32 mm MLS  5x 	14-32344-01 2x 1331316 (8x) 	71-38558-00 2x LR029132 	12-38546-01 24x 1311285 (24x) 	71-34888-00 2x 1336543  71-38291-00 1x ESR3737 	71-38527-00 LR005994 	81-34316-00 K↔ 1102415 35x50 A SL RD PTFE ACM  81-90050-00 K↔ LR036542  81-38536-00 N 3x 1311318 26x45 A SL WD FPM 
--	--	--	--	---	---	---	---	--	---	--



LAND ROVER

Ltr. 2.7 276DT 140-147 kW (190-200 PS) DISCOVERY TD 09/04-12/18

	02-38558-03	08-38527-03		61-34875-10 2x LR009719 82,5 Ø 1,17 mm MLS	14-32344-01 2x 1331316 (8x)	71-38558-00 2x LR029132	12-38546-01 24x 1311285 (24x)	71-34888-00 2x 1336543	71-38527-00 2x LR005994	81-34316-00 K➔ 1102415 35x50 A SL RD PTFE ACM	81-90050-00 K➔ LR036542	81-38536-00 N 3x 1311318 26x45 A SL WD FPM
				61-34875-20 2x LR009721 82,5 Ø 1,22 mm MLS			70-38546-00 24x 1311285					
				61-34875-30 2x LR009722 82,5 Ø 1,27 mm MLS								
				61-34875-40 2x LR009723 82,5 Ø 1,32 mm MLS								

2.8 M52 B28 140 kW (190 PS) DEFENDER 11/98-09/03

	02-31940-02 1427826	08-27698-03 1740981		61-31940-00 1726617 85 Ø 1,75 mm	14-32002-02 1721938	15-31401-01 1703342 +1748872 (2X)	12-31306-05 24x LR002556 (24x)	71-31403-00 2x 1740069	71-27698-10 9065875	81-17404-50 K➔ 1275466 48x65 AB SL RD FPM	81-20745-40 K➔ 2245364 90x110 A SL LD FPM
				61-31940-10 1726620 85 Ø 2,05 mm			70-31306-00 24x LDY000060	71-31404-00 2x 1744252			

3.0 AJ20D6 147-221 kW (200-300 PS) DEFENDER D DISCOVERY D RANGE ROVER VELAR 07/20 **[NEW]**

				61-11241-00 LR151671 84 Ø 0,9 mm MLS	14-21242-01 LR125319 (14X)	71-21240-00 LR125592	12-13246-02 24x LR073776 (24x)	71-21239-00 12x LR133631	70-31414-10	81-10672-00 K➔ LR121757 PTFE	81-10396-00 K➔ LR122697 92x109 LD Gummi
				61-11241-10 LR151674 84 Ø 1 mm MLS			70-13246-00 24x LR073776				
				61-11241-20 LR151677 84 Ø 1,1 mm MLS							
				61-11241-30 LR151683 84 Ø 1,2 mm MLS							
				61-11241-40 LR151684 84 Ø 1,3 mm MLS							

LAND ROVER

Ltr.	30DDTX 306DT	155-260 kW (211-354 PS)	DISCOVERY IV TD DISCOVERY SDV6 DISCOVERY TD DISCOVERY V SDV6 RANGE ROVER D RANGE ROVER Hybrid D RANGE ROVER IV RANGE ROVER IV D RANGE ROVER IV Hybrid D RANGE ROVER SPORT D RANGE ROVER SPORT Hybrid D RANGE ROVER SPORT TD RANGE ROVER VELAR D	09/09														
3,0	30DDTX 306DT	155-260 kW (211-354 PS)	DISCOVERY IV TD DISCOVERY SDV6 DISCOVERY TD DISCOVERY V SDV6 RANGE ROVER D RANGE ROVER Hybrid D RANGE ROVER IV RANGE ROVER IV D RANGE ROVER IV Hybrid D RANGE ROVER SPORT D RANGE ROVER SPORT Hybrid D RANGE ROVER SPORT TD RANGE ROVER VELAR D	09/09		<p><b>02-38558-02</b></p>	<p><b>08-38527-02</b></p>		<p><b>61-36610-00</b> 2x LR013063 85 Ø 1,17 mm MLS</p>	<p><b>14-32344-01</b> 2x 1331316 (8x)</p>	<p><b>71-38558-00</b> 2x LR029132</p>	<p><b>12-38546-01</b> 24x 1311285 (24x)</p>	<p><b>71-34888-00</b> 2x 1336543</p>	<p><b>71-38527-00</b> LR005994</p>	<p><b>81-34316-00 K</b> → 1102415 35x50 A SL RD PTFE ACM</p>	<p><b>81-90050-00 K</b> → LR036542</p>	<p><b>81-38536-00 N</b> 3x 1311318 26x45 A SL WD FPM</p>	
3,0	306D1	130 kW (177 PS)	RANGE ROVER D	03/02-08/12		<p><b>02-35176-01</b> LDY000010</p>	<p><b>08-37313-01</b> WLB000010</p>	<p><b>04-10029-01</b> →</p>	<p><b>61-35000-00</b> 1x LVB000290 84,5 Ø 1,45 mm MLS</p>	<p><b>14-32004-01</b> STC2023</p>	<p><b>71-37402-00</b> LVP000040</p>	<p><b>12-35172-02</b> 24x LDY000050</p>	<p><b>71-33109-10</b> 6x LKJ101120L</p>	<p><b>71-37313-00</b> 8510364</p>	<p><b>81-37002-00 K</b> → LUF100530L 55x68 AB RD PTFE</p>	<p><b>81-20745-00 K</b> → LUF100540L 90x110 AB SL LD PTFE (Polytetrafluorethylen)/ACM (Polyacryl-Kautschuk)</p>		
3,0	306PS	250 kW (340 PS)	DISCOVERY	08/13-12/18					<p><b>61-10739-00 R</b> LR1 05300 85,4 Ø 0,6 mm MLS</p>			<p><b>12-19295-02</b> 24x LR078819 (24x)</p>	<p><b>71-17234-00</b> 2x LR0 41681</p>	<p><b>71-17234-00</b> 2x LR0 41681</p>		<p><b>70-19295-00</b> 24x LR078819</p>		
									<p><b>61-10740-00 L</b> LR041641 85,4 Ø 0,6 mm MLS</p>									





LAND ROVER													
Ltr.													
3,0 306PS 254 kW (345 PS)	DISCOVERY IV RANGE ROVER IV RANGE ROVER SPORT	09/12											
3,2 B 6324 S 171 kW (233 PS)	FREELANDER 2	10/06-10/14											
3,5 22 D 113-122 kW (154-166 PS)	DISCOVERY DISCOVERY I	06/89-06/94											



**LAND ROVER**

Ltr.  3,6 368DT 200 kW (272 PS)

 RANGE ROVER III D  
RANGE ROVER SPORT D

 04/06-03/13

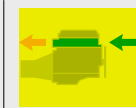

**61-36270-00 L**  
1418990  
82,5 Ø  
1 mm  
MLS

**61-36270-10 L**  
1418991  
82,5 Ø  
1,1 mm  
MLS

**61-36270-20 L**  
1418992  
82,5 Ø  
1,15 mm  
MLS

**61-36270-30 L**  
1418993  
82,5 Ø  
1,2 mm  
MLS

**61-36270-40 L**  
1418996  
82,5 Ø  
1,25 mm  
MLS

**61-36275-00 R**  
1418984  
82,5 Ø  
1 mm  
MLS

**61-36275-10 R**  
1418985  
82,5 Ø  
1,1 mm  
MLS

**61-36275-20 R**  
LR00635  
82,5 Ø  
1,15 mm  
MLS

**61-36275-30 R**  
1418987  
82,5 Ø  
1,2 mm  
MLS

**61-36275-40 R**  
1418989  
82,5 Ø  
1,25 mm  
MLS

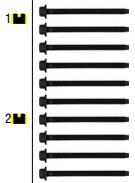

**14-32344-02**  
1331316 (10x)

2x

**71-13228-00 R**  
LR005898



**71-13229-00 L**  
LR005897

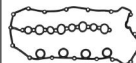

**12-38546-02**  
1311285 (16x)

2x



**70-38546-00**  
1311285

32x



**71-36521-00**  
1420910

2x



**71-13235-00**  
LR002438



**81-34316-00 K**  
1102415  
35x50  
A SL RD PTFE ACM

















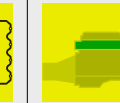
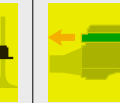
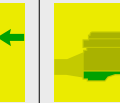
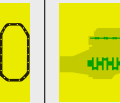
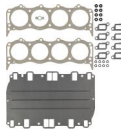









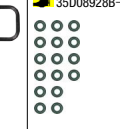

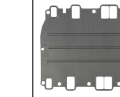

**81-10502-00 K**  
LR005539  
92 Ø  
PTFE



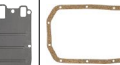







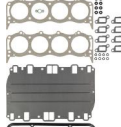









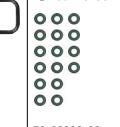

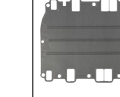

LAND ROVER

Ltr.  3,9 35 D 134 kW (182 PS) RANGE ROVER 11/88-07/94  1

										
	<p><b>02-35375-01</b> STC1641 ➔ 35D08927B</p>   <p><b>02-35380-01</b> STC2822 ➔ 35D08928B➔</p> 	<p><b>08-35523-01</b> STC1639 ➔ 35D08927B</p>   <p><b>08-35523-02</b> STC2823 ➔ 35D08928B➔</p>  		<p><b>61-35375-00</b> 2x ETC7819 91,5 Ø MLS ➔ 35D08927B</p>  <p><b>61-35380-00</b> 2x LV8500030 95,6 Ø ➔ 35D08928B➔</p> 		<p><b>71-35524-10</b> 2x LVC100260</p> 	<p><b>12-36903-01</b> ERR1782 (16x) ➔ 35D08928B➔</p>  <p><b>70-36903-00</b> 16x ERR1782 ➔ 35D08928B➔</p> 	<p><b>71-35528-00</b>   LKJ500020</p>  <p><b>71-35527-00</b>  8x ERC3605 ➔ 35D08927B</p>  <p><b>71-35532-00</b>  4x ERR6733 ➔ 35D08928B➔</p> 	<p><b>71-35531-00</b> 602087</p> 	<p><b>81-35519-00</b>  ERR6490 48,6x63,65 RD</p>  <p><b>81-35523-00</b>  ERR2640 82x98,5 LD</p> 

3,9 36 D 134 kW (182 PS) RANGE ROVER 11/88-07/94

	<p><b>02-35375-01</b> STC1641 ➔ 36D25154B</p>   <p><b>02-35380-01</b> STC2822 ➔ 36D25155B➔</p> 	<p><b>08-35523-01</b> STC1639 ➔ 36D25154B</p>   <p><b>08-35523-02</b> STC2823 ➔ 36D25155B➔</p>  		<p><b>61-35375-00</b> 2x ETC7819 91,5 Ø MLS ➔ 36D25154B</p>  <p><b>61-35380-00</b> 2x LV8500030 95,6 Ø ➔ 36D25155B➔</p> 		<p><b>71-35524-10</b> 2x LVC100260</p> 	<p><b>12-36903-01</b> ERR1782 (16x) ➔ 36D25155B➔</p>  <p><b>70-36903-00</b> 16x ERR1782 ➔ 36D25155B➔</p> 	<p><b>71-35528-00</b>  LKJ500020</p>  <p><b>71-35527-00</b>  8x ERC3605 ➔ 36D25154B</p>  <p><b>71-35532-00</b>  4x ERR6733 ➔ 36D25155B➔</p> 	<p><b>71-35531-00</b> 602087</p> 	<p><b>81-35519-00</b>  ERR6490 48,6x63,65 RD</p>  <p><b>81-35523-00</b>  ERR2640 82x98,5 LD</p> 
--	---	---	--	--	--	--	---	---	--	--

LAND ROVER

Ltr.  3,9 37 D 127 kW (173 PS) RANGE ROVER 11/88-07/94

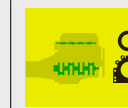
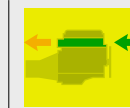

3,9 37 D 127 kW (173 PS) RANGE ROVER 11/88-07/94

**02-35375-01**  
STC1641  
➡ 37D02931B



**02-35380-01**  
STC2822  
➡ 37D02932B →



**08-35523-01**  
STC1639  
➡ 37D02931B



**08-35523-02**  
STC2823  
➡ 37D02932B →



**61-35375-00** 2x  
ETC7819  
91,5 Ø  
MLS  
➡ 37D02931B



**61-35380-00** 2x  
LV8500030  
95,6 Ø  
➡ 37D02932B →



**71-35524-10** 2x  
LVC100260



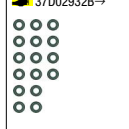

**12-36903-01**  
ERR1782 (16x)  
➡ 37D02932B →



**70-36903-00**  
ERR1782  
➡ 37D02932B →



**71-35528-00**    
LKJ500020

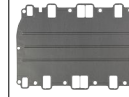

**71-35527-00** 8x  
ERC3605  
➡ 37D02931B





**71-35532-00** 4x  
ERR6733  
➡ 37D02932B →





**71-35531-00**  
602087



**81-35519-00**   
ERR6490  
48,6x63,65  
RD



**81-35523-00**   
ERR2640  
82x98,5  
LD



3,9 37 L 134-136 kW (182-185 PS) DEFENDER 01/93-02/16

**61-35380-00**  
LV8500030  
95,6 Ø



3,9 38 D 127 kW (173 PS) RANGE ROVER 11/88-07/94

**02-35375-01**  
STC1641  
➡ 38D27237B



**02-35380-01**  
STC2822  
➡ 38D27238B →



**08-35523-01**  
STC1639  
➡ 38D27237B



**08-35523-02**  
STC2823  
➡ 38D27238B →



**61-35375-00** 2x  
ETC7819  
91,5 Ø  
MLS  
➡ 38D27237B



**61-35380-00** 2x  
LV8500030  
95,6 Ø  
➡ 38D27238B →



**71-35524-10** 2x  
LVC100260





**12-36903-01**  
ERR1782 (16x)  
➡ 38D37238B →



**70-36903-00**  
ERR1782  
➡ 38D37238B →



**71-35528-00**    
LKJ500020

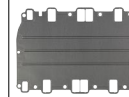

**71-35527-00** 8x  
ERC3605  
➡ 38D27237B





**71-35532-00** 4x  
ERR6733  
➡ 38D27238B →





**71-35531-00**  
602087



**81-35519-00**   
ERR6490  
48,6x63,65  
RD



**81-35523-00**   
ERR2640  
82x98,5  
LD



LAND ROVER															
3,9	42 D	136-142 kW (185-193 PS)	RANGE ROVER RANGE ROVER II	10/89-03/02		<b>02-35380-01</b> STC2822 	<b>08-35523-02</b> STC2823 		<b>61-35380-00</b> 2x LV8500030 95,6 Ø 		<b>71-35524-10</b> 2x LVC100260 	<b>12-36903-01</b> ERR1782 (16x) 	<b>71-35528-00</b>	<b>71-35531-00</b> 602087 	<b>81-35519-00</b> ERR6490 48,6x63,65 RD <b>81-35523-00</b> ERR2640 82x98,5 LD
3,9	42 D	140 kW (190 PS)	RANGE ROVER	07/94-03/02		<b>02-35380-01</b> STC2822 	<b>08-35523-02</b> STC2823 		<b>61-35380-00</b> 2x LV8500030 95,6 Ø 		<b>71-35524-10</b> 2x LVC100260 	<b>12-36903-01</b> ERR1782 (16x) 	<b>71-35528-00</b>	<b>71-35531-00</b> 602087 	<b>81-35519-00</b> ERR6490 48,6x63,65 RD <b>81-35523-00</b> ERR2640 82x98,5 LD
4,0	35 D	134 kW (182 PS)	DISCOVERY V8	09/93-10/98	<b>02-35375-01</b> STC1641 	<b>08-35523-01</b> STC1639 	<b>08-35523-02</b> STC2823 	<b>61-35375-00</b> 2x ETC7819 91,5 Ø MLS 	<b>61-35380-00</b> 2x LV8500030 95,6 Ø 		<b>71-35524-10</b> 2x LVC100260 	<b>12-36903-01</b> ERR1782 (16x) 	<b>71-35528-00</b>	<b>71-35531-00</b> 602087 	<b>81-35519-00</b> ERR6490 48,6x63,65 RD <b>81-35523-00</b> ERR2640 82x98,5 LD

**LAND ROVER**

Ltr. 4,0 35 D 136 kW (185 PS) DISCOVERY V8 11/98-06/04

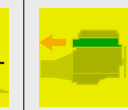

02-35375-01  
STC1641  
➔ 35D08927B

02-35380-01  
STC2822  
➔ 35D08928B➔

08-35523-01  
STC1639  
➔ 35D08927B

08-35523-02  
STC2823  
➔ 35D08928B➔

61-35375-00 2x  
ETC7819  
91,5 Ø  
MLS  
➔ 35D08927B

61-35380-00 2x  
LV8500030  
95,6 Ø  
➔ 35D08928B➔

71-35524-10 2x  
LVC100260

12-36903-01  
ERR1782 (16x)  
➔ 35D08928B➔

70-36903-00 16x  
ERR1782  
➔ 35D08928B➔

71-35528-00 1x  
LKJ500020

71-35527-00 8x  
ERC3605  
➔ 35D08927B

71-35532-00 4x  
ERR6733  
➔ 35D08928B➔

71-38291-00 08  
ESR3737

71-35531-00  
602087

81-35519-00 K➔  
ERR6490  
48,6x63,65  
RD

81-35523-00 K➔  
ERR2640  
82x98,5  
LD

02-35375-01  
STC1641  
➔ 36D25154B

02-35380-01  
STC2822  
➔ 36D25155B➔

08-35523-01  
STC1639  
➔ 36D25154B

08-35523-02  
STC2823  
➔ 36D25155B➔

61-35375-00 2x  
ETC7819  
91,5 Ø  
MLS  
➔ 36D25154B

61-35380-00 2x  
LV8500030  
95,6 Ø  
➔ 36D25155B➔

71-35524-10 2x  
LVC100260

12-36903-01  
ERR1782 (16x)

70-36903-00  
ERR1782

71-35528-00 1x  
LKJ500020

71-35527-00 8x  
ERC3605  
➔ 36D25154B

71-35532-00 4x  
ERR6733  
➔ 36D25155B➔

71-35531-00  
602087

81-35519-00 K➔  
ERR6490  
48,6x63,65  
RD

81-35523-00 K➔  
ERR2640  
82x98,5  
LD

4,0 37 L 136 kW (185 PS) DISCOVERY 09/93-10/98

61-35380-00  
LV8500030  
95,6 Ø

LAND ROVER																		
Ltr.			<b>1</b> <b>[NEW]</b>															
4,0	406PN	156-161 kW (212-219 PS)	DISCOVERY	10/04-12/18														
					<b>02-11228-02</b>	<b>08-21059-01</b> LR002817			<b>61-11228-00 R</b> LR003548 102,5 Ø 0,6 mm MLS		<b>71-21060-00</b> LR126242	2x	<b>12-21058-01</b> 1025374 (12X)	<b>71-21056-00</b> 4537676	6x	<b>71-21059-00</b> 1025228	<b>81-51109-30</b> 1316639 42x56 A SL RD FPM	
								<b>61-11229-00 L</b> LR003549 102,5 Ø 0,6 mm MLS					<b>70-21058-00</b> 1025374	<b>71-21055-00</b> 4600701	2x	<b>71-21085-00</b> 4639173	<b>81-10670-00</b> 4719898 60x76 A SL LD LD FPM	
4,0	42 D	136 kW (185 PS)	RANGE ROVER	01/95-03/02														
					<b>02-35380-01</b> STC2822	<b>08-35523-02</b> STC2823			<b>61-35380-00</b> LV8500030 95,6 Ø	2x	<b>71-35524-10</b> LVC100260	2x	<b>12-36903-01</b> ERR1782 (16x)	<b>71-35528-00</b> LKJ500020	4x	<b>71-35531-00</b> 602087	<b>81-35519-30</b> ERR6490 48,6x63,65 RD	
																	<b>81-35523-00</b> ERR2640 82x98,5 LD	
4,2	428PS	287-298 kW (390-405 PS)	RANGE ROVER RANGE ROVER III RANGE ROVER SPORT	02/05-03/13														
					<b>01-10355-01</b> LR006635				<b>61-10107-00 R</b> 4628399 87,3 Ø 0,55 mm MLS		<b>14-10987-01</b> 1323255 (20x)		<b>71-10904-00 A R</b> LVP500010	<b>12-10908-01</b> 3598716 (16x)	2x	<b>71-10903-00</b> 4628226	<b>70-31414-10</b> 	<b>81-10433-00</b> 4526537 57x82 PTFE
																	<b>81-10434-00</b> 4352327 100x120 PTFE	
								<b>61-10108-00 L</b> 4628400 87,3 Ø 0,55 mm MLS		<b>71-10905-00 A L</b> LDR500150		<b>71-10908-00</b> 3598716	32x	<b>71-13215-00</b> 4694621	<b>71-13216-00</b> 4603139			
4,3	40 D	149 kW (203 PS)	RANGE ROVER	09/92-07/94														
					<b>02-35380-01</b> STC2822	<b>08-35523-02</b> STC2823			<b>61-35380-00</b> LV8500030 95,6 Ø	2x	<b>71-35524-10</b> LVC100260	2x	<b>12-36903-00</b> ERR1782	<b>71-35528-00</b> LKJ500020	4x	<b>71-35531-00</b> 602087	<b>81-35519-30</b> ERR6490 48,6x63,65 RD	
																	<b>81-35523-00</b> ERR2640 82x98,5 LD	

LAND ROVER													
Ltr.													
4,4 M62 B44	210 kW (286 PS)	RANGE ROVER	03/02-08/05		<p><b>02-33396-01</b> LV0000020</p>	<p><b>08-31828-03</b></p>	<p><b>61-31370-00 L</b> LVB000340 93 Ø 1,74 mm MLS</p> <p><b>61-31370-10 L</b> LVB000350 93 Ø 2,07 mm MLS</p> <p><b>61-31375-00 R</b> LVB000360 93 Ø 1,74 mm MLS</p> <p><b>61-31375-10 R</b> LVB000370 93 Ø 2,07 mm MLS</p>	<p><b>14-32005-01</b> LVG000200</p>	<p><b>15-33396-01 L</b> LR003817 +LVP000030</p> <p><b>15-33397-01 R</b> LR003813 +LVP000030</p>	<p><b>12-31306-12</b> LDY000060 (16x)</p> <p><b>70-31306-00</b> LDY000060</p>	<p><b>71-31853-00 L</b> LKJ000040</p> <p><b>71-31834-10</b> LKG000100</p> <p><b>71-31836-10</b> LKG000100</p>	<p><b>71-31828-00</b> LVF000030</p> <p><b>71-40369-00 00</b> LVF000040</p>	<p><b>81-17404-50 K</b> 1275466 48x65 AB SL RD FPM</p> <p><b>81-27373-00 K</b> LUF000020 100x125 A SL LD FPM</p>
4,4 448DT	230-253 kW (313-344 PS)	RANGE ROVER IV RANGE ROVER SPORT D RANGE ROVER V8 D	07/10				<p><b>61-10292-00 R</b> LR022899 85 Ø 0,95 mm MLS</p> <p><b>61-10293-00 L</b> LR022897 85 Ø 0,95 mm MLS</p>	<p><b>14-32344-02</b> 1331316 (10x)</p>	<p><b>71-13226-00 L</b> LR035029</p> <p><b>71-13227-00 R</b> LR035031</p>	<p><b>12-38546-02</b> 1311285 (16x)</p> <p><b>70-38546-00</b> 1311285</p>	<p><b>71-39243-00</b> LR022802</p>	<p><b>71-13236-00</b> LR023018</p>	<p><b>81-34316-00 K</b> 1102415 35x50 A SL RD PTFE ACM</p> <p><b>81-10508-00 K</b> LR029001 90 Ø PTFE</p>
4,4 448PN	220-225 kW (299-306 PS)	DISCOVERY RANGE ROVER	09/02-03/13	<p><b>01-10356-01</b> LR006645</p>			<p><b>61-10305-00 L</b> 4585202 89,3 Ø 0,55 mm MLS</p> <p><b>61-10306-00 R</b> 4585198 89,3 Ø 0,55 mm MLS</p>	<p><b>14-10987-01</b> 1323255 (20x)</p>	<p><b>71-10904-00 A R</b> LVP500010</p> <p><b>71-10905-00 A L</b> LDR500150</p> <p><b>71-10983-00 L</b> LDR500180</p>	<p><b>12-10908-01</b> 3598716 (16x)</p> <p><b>70-10908-00</b> 3598716</p>	<p><b>71-10903-00 L</b> 4628226</p> <p><b>71-13222-00 L</b> 4628235</p> <p><b>71-13215-00</b> 4694621</p> <p><b>71-13216-00</b> 4603139</p>	<p><b>70-31414-10</b></p>	<p><b>81-10433-00 K</b> 4526337 57x82 PTFE</p> <p><b>81-10434-00 K</b> 4352327 100x120 PTFE</p>



LAND ROVER														
Ltr.														
4,6 46 D	165-168 kW (224-228 PS)	RANGE ROVER	07/94-03/02		<b>02-35380-01</b> STC2822 	<b>08-35523-02</b> STC2823 		<b>61-35380-00</b> 2x LV8500030 95,6 Ø 		<b>71-35524-10</b> 2x LVC100260 		<b>71-35528-00</b> LKJ500020 	<b>71-35531-00</b> 602087 	<b>81-35519-00</b> ERR6490 48,6x63,65 RD 
													<b>81-35523-00</b> ERR2640 82x98,5 LD 	
5,0 508PN	276-280 kW (375-381 PS)	DISCOVERY IV DISCOVERY V8 RANGE ROVER IV V8 RANGE ROVER SPORT RANGE ROVER SPORT V8 RANGE ROVER V8	07/09					<b>61-10884-00 R</b> LR105294 93,3 Ø 0,6 mm MLS 		<b>15-19435-01 R</b> LR010882 +LR011220 (4X)  <b>15-19436-01 L</b> LR010789 +LR014345 (4X) 	<b>12-19295-01</b> LR078819 (32X) 	<b>71-19434-00</b> 8x LR010881 	<b>70-31414-10</b> 	
								<b>61-10971-00 L</b> LR105293 93,3 Ø 0,6 mm MLS 			<b>70-19295-00</b> 32x LR078819 			
5,0 508PS	372-423 kW (506-575 PS)	DEFENDER RANGE ROVER IV V8 RANGE ROVER SPORT RANGE ROVER SPORT Hybrid V8 RANGE ROVER SPORT V8 RANGE ROVER VELAR V8 RANGE ROVER V8	04/09					<b>61-10884-00 R</b> LR105294 93,3 Ø 0,6 mm MLS 		<b>15-19435-01 R</b> LR010882 +LR011220 (4X)  <b>15-19436-01 L</b> LR010789 +LR014345 (4X) 	<b>12-19295-01</b> LR078819 (32X) 	<b>71-19463-00</b> LR011585 	<b>70-31414-10</b> 	
								<b>61-10971-00 L</b> LR105293 93,3 Ø 0,6 mm MLS 			<b>70-19295-00</b> 32x LR078819 	<b>71-19464-00</b> LR011586 		

# Haftungsausschluss

## (für Katalog)

**Alle Angaben in unserem Katalog** wurden von uns sorgfältig geprüft, sind jedoch unverbindlich. Ersatzansprüche wegen Katalogangaben werden von uns nicht anerkannt. Der Käufer ist selbst verpflichtet, zu prüfen, ob unsere Teile für seine Zwecke geeignet sind. In allen Zweifelsfällen sollte Rücksprache mit unserem technischen Kundendienst erfolgen **Tel. +49 731 7046 999**.

**Technische Weiterentwicklungen** oder Änderungen bleiben vorbehalten, soweit damit keine Nachteile für den Kunden verbunden sind.

**Angaben, Namens- und Markenzeichen,** Beschreibungen, Nummern von Fahrzeugnummern und Herstellerzeichen, Original-Ersatzteilnummern der Fahrzeug- und Motorenhersteller u. a. sind ausschließlich für interne Zwecke gedacht. Solche Kennzeichnungen dürfen Fahrzeugbesitzern gegenüber nicht verwendet werden.

**Wir weisen ausdrücklich darauf hin,** dass alle von uns gelieferten Teile von geschultem Fachpersonal einzubauen sind. Reinz haftet für Fehler in diesem Katalog nur, wenn diese für den Kunden nicht offenbar erkennbar sind sowie nur bei Vorsatz und grober Fahrlässigkeit von Reinz, eines Vertreters oder eines Erfüllungsgehilfen. Dieser Haftungsausschluss gilt nicht im Rahmen

des Anwendungsbereichs des Produkthaftungsgesetzes und nicht bei Verletzung von Körper, Leben und Gesundheit, sowie bei der Verletzung von sog. Kardinalpflichten. Darüber hinaus ist unsere Haftung für Schäden, insbesondere für Personen-, Sach- oder Vermögensschäden, die unmittelbar oder mittelbar im Zusammenhang mit der Nutzung dieses Kataloges auftreten, sowie für nicht voraussehbare Schäden ausgeschlossen.

**Reinz ist Inhaber aller Schutzrechte** an den in diesem Katalog gespeicherten Daten. Kopie, Nachdruck, ganze oder teilweise Übernahme der Inhalte und Vervielfältigung, auch auszugsweise, ist nur mit unserer vorheriger schriftlicher Zustimmung sowie mit unserem Urheberrechtsvermerk zulässig.

Für Bestellungen, welche ab dem Erscheinungsdatum eines neuen Katalogs getätigt werden, sind alleine die Angaben des neuen Katalogs maßgeblich. Auf Angaben im Vorkatalog kann bei Neubestellungen nicht mehr zurückgegriffen werden.

**Sofern Sie noch Fragen haben, bitten wir Sie, sich mit uns in Verbindung zu setzen.**

[VictorReinz.com/AGB](http://VictorReinz.com/AGB)

# Exclusion of Liability

## (for catalog)

**All details in our catalog** have been thoroughly checked by us but are however not binding. Right to damages on account of catalog details will not be recognized. The purchaser is obliged to check if our parts are suitable for their use. In all doubtful cases, the purchaser should consult our technical customer service under **+49 731 7046 999**.

**We reserve the right** to further technical developments or changes as long as no disadvantage for the customer results.

**Details, name and trademarks,** descriptions, numbers from vehicle numbers and manufacturer symbols, original vehicle replacement part numbers and engine manufacturer etc. are solely for internal use. Such labels must not be used with vehicle owners.

**We specifically point out** that all parts supplied by us must be assembled by trained specialists.

**Reinz is liable for mistakes** in this catalog only when they are not clearly recognizable for the customer, as well as by intent or gross negligence on the part of Reinz, its representative or vicarious agent. This exclusion of liability does not apply within the framework of the field of

application of the product liability laws and not by bodily harm, life and health, as well as by violation of cardinal duties. In addition, our liability for damages, especially personal, property or financial damages that occur directly or indirectly as a result of the use of this catalog, as well as non-foreseeable damages are excluded.

**Reinz is the owner of all patent rights** on the data stored in this catalog. Copies, reprints, whole or partial takeover of the contents and duplication even in excerpts are only permissible with our prior written approval, as well as with our copyright note.

**For orders placed after the publication date** of a new catalog, only the details in the new catalog are binding and no fall back to details in the previous catalog is possible.

**In case you have further questions, do not hesitate to contact us.**

[VictorReinz.com/AGB](http://VictorReinz.com/AGB)



**VictorReinz.com**

**reinz.info@dana.com**

**Technical Hotline +49 (0)731 7046-9 99**

**REINZ-Dichtungs-GmbH**

Reinzstrasse 3-7  
89233 Neu-Ulm  
Germany  
+49 (0)731 7046-0

***VICTOR REINZ***<sup>®</sup>

---

