

VICTOR REINZ®

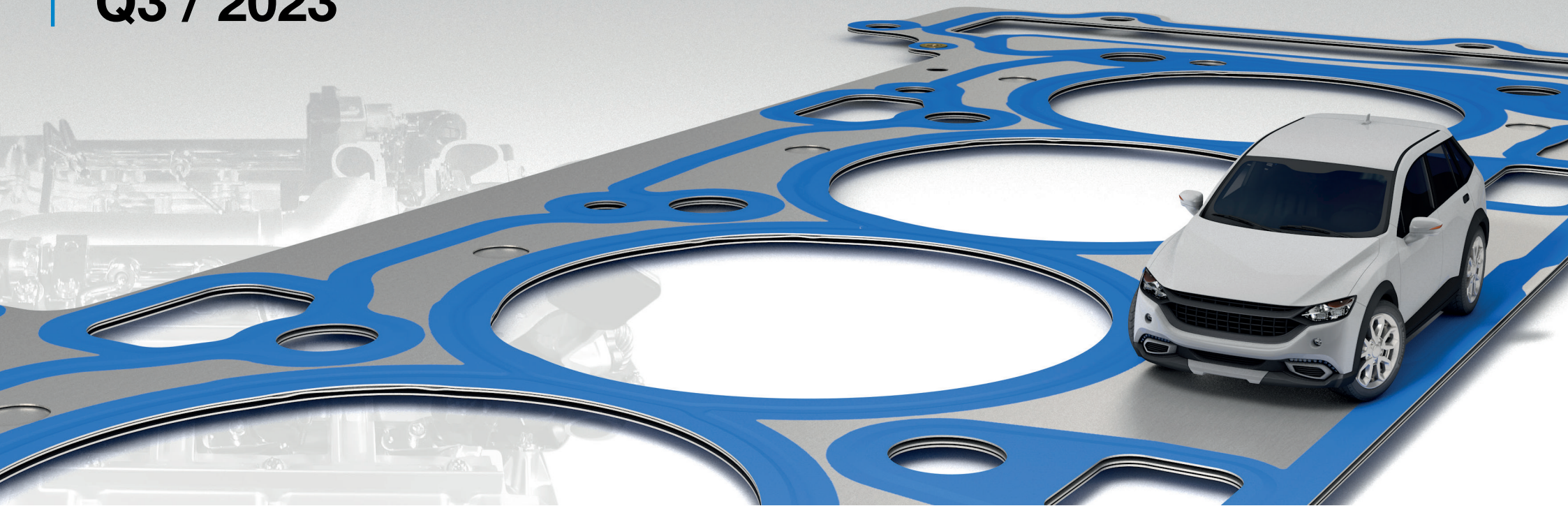

MAZDA
Q3 / 2023



VictorReinz.com/online-catalog

Victor Reinz®

at a Glance



Online Catalog

VictorReinz.com/online-catalog



Newsletter

VictorReinz.com/EN/News/Newsletter.aspx?region



Youtube

www.youtube.com/user/VictorReinzSealingEN



Catalog News

VictorReinz.com/news



Technical Service Information

VictorReinz.com/tsi



Facebook

www.facebook.com/VictorReinzParts



Just seal it!

VictorReinz.com/jsi



Technical Datasheet

VictorReinz.com/jsi-datasheet



LinkedIn

www.linkedin.com/showcase/victor-reinz-emea



Safety Datasheet

VictorReinz.com/jsi-datasheet



Homepage

VictorReinz.com

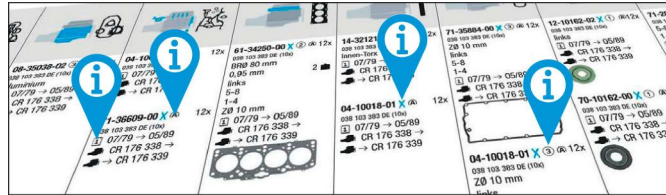

[VictorReinz.com/catalog-info](https://www.victorreinz.com/catalog-info)

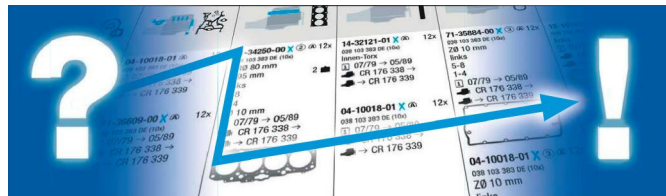

[VictorReinz.com/catalog-how-to-use](https://www.victorreinz.com/catalog-how-to-use)

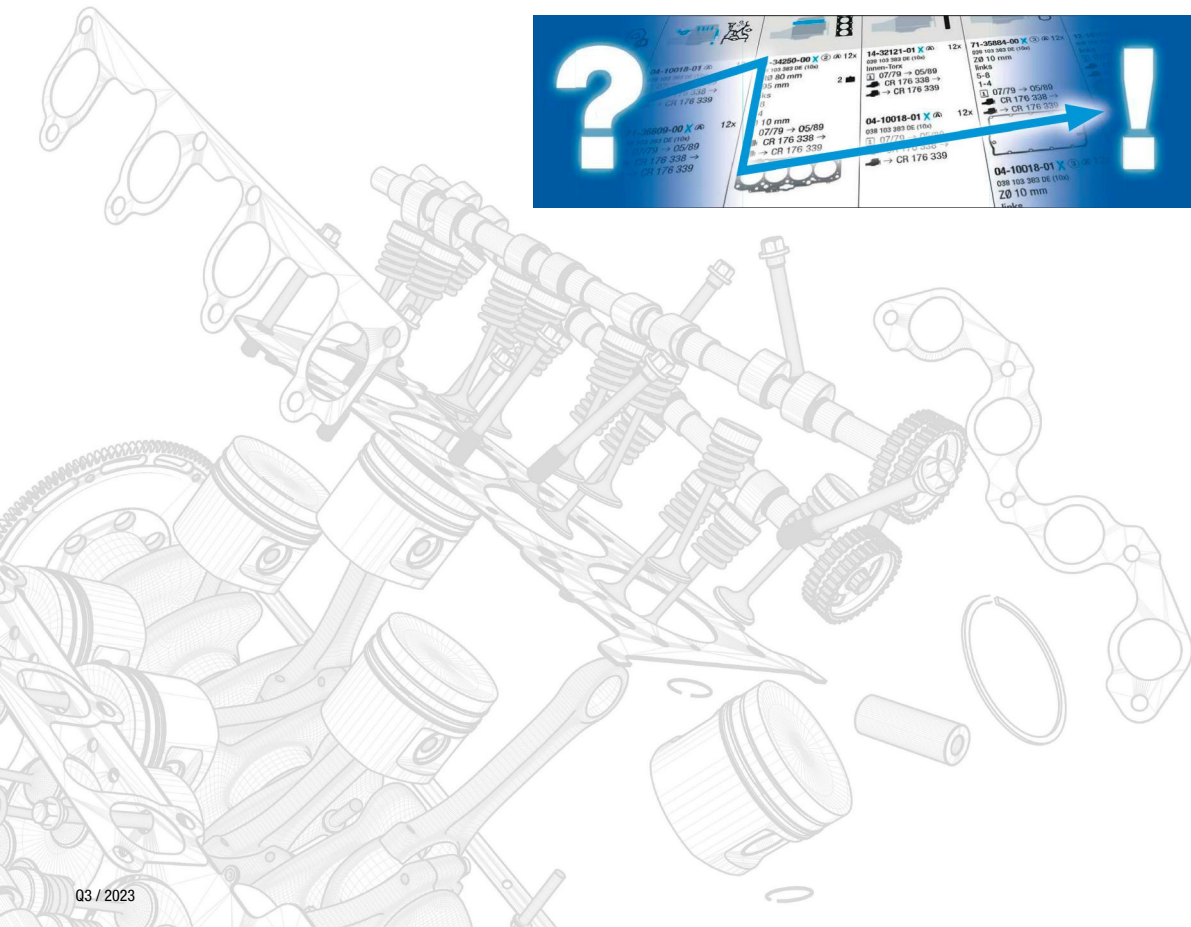

MAZDA



Code

0-9	
1E04(J4C)	10
1E04(J4J)	10
1E04(JJA)	10
1E04(JJC)	10
1E04(JJM)	10
1E05(DHA)	11
1E05(DHB)	11
1E05(DHF)	11
1E06(DHA)	11
1E06(DHB)	11
1E06(DHF)	11
1E07(RTJ)	38
1E07(RTK)	38
1E09(J4C)	10
1E09(J4J)	10
1E09(JJA)	10
1E09(JJC)	10
1E09(JJM)	10
1E10(RTN)	39
1E12(RTJ)	38
1E12(RTK)	38
1E13(J4C)	10
1E13(J4J)	10
1E13(JJA)	10
1E13(JJC)	10
1E13(JJM)	10
1E16(RTJ)	38
1E16(RTK)	38
1N2-FE	20
1V	76
4EE1-T	30
4G18	29
4G54	73
4JJ3-TCX	75
8AN1	23
99V	76

A

AJ	73-74
AJ03	73

B

B1	6
B116	6



Code

B3	6-7
B3 (16V)	8
B3 ME	7-8
B335	6
B33G	7
B383	9
B3E	9
B5	13
B50	13
B53	13
B6	20
B6 (SOHC)	20
B6 Turbo	21
B64F	23
B65L	20
B65M	24
B67J	20
B67K	20
B67L	20
B68	20, 25
B69N	25
B6DA	22
B6E	22
B6MC	23
B6MU	23
B6ZE	23
BP	41
BP (DOHC)	31
BP-ZE	31-32
BP22	31
BP31	31
BP52	31
BP5A	32
BP6J	31, 33
BPC	31
BPD	31
BPF1	32

C

CA	75
CAY1	75
CAY5	75
CAY6	75
CR12DE	6
CYC4	75



Code

D	
D6DK	22
E	
E1	6
E3	9
E5	14-15
E5E2	14
E5E3	14
F	
F1F6	12
F2	57-58
F2-EGI	58
F21	58
F2E	58
F2G	59
F2L1	57
F2T	59
F6	26
F6JA	12
F6JB	12
F8 (8V)	34
F8 (12V)	35
FE (12V)	40
FE (16V)	40
FE (8V)	41
FE-3L	41
FE-3M	41
FE18	41
FE58	41
FE60	41
FE61	41
FEBN	41
FECK	41
FECM	40
FEFA	41
FET	41
FEV4	41
FEY7	41
FEY9	40
FP	33-34, 39
FP01LP	33
FP55	34, 39
FP87	34



Code

FPD9	34
FPE1	34
FPY3	34, 39
FS	42
FS-DS	42
FS2C	42
FS7E	42
FS7G	42
FUJA	10
FXJA	12
FYJA	26
G	
G54B	73
G6	73
G6 (12V)	73
G6Y0	73
GY-DE	66
GY1	67
H	
HA	74
HE3	42
HEE	42
HFY1	43
HFY7	43
HR15DE	15
HR16DE	26
J	
JJA	10
K	
K8-ZE	36
K819	36
K8D9	35
K8Y1	35
KF	43
KF1	43
KFZE	44
KJ-ZEM	63
KL	67
KL-ZE	67



Code

L	
L3	64
L3-V	64, 66
L3-VDT	65
L3-VE	64
L333	64
L3C1	64-65
L3K7	65
L3KG	65
L3M6	65
L3N9	65
L3X	64
L3Y7	65
L3YH	65
L5-VE	68
L5-X	69
L813	36
L823	36
L828	37
L829	36
L831	37
L850	37
LF-DE	44-45
LF-VD	44
LF-VDS	44
LF-VE	46
LF-ZB	47
LF17	49
LF18	49
LF4J	44
LF4K	44
LF50	50
LF5H	50
LF5W	50
LF62	46
LF72	50
LF77	45-46
LFG7	46
LFG8	46
LFN7	44
LFN8	44
LFY7	46
LFYA	44
LFYB	44
LFZ2	48

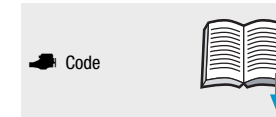

Code

LFZD	46
M	
M	42
MA	42
MD25NA	69
MD25TI	70
P	
P4-AT	59
P5-AT	75
P5-VPR	15
P5X0	16
P5X1	16
P5X2	16
P5X4	16
P5X5	16
P5XB	16
P5XC	16
P5Y1	17
P5Y4	17
P5Y5	17
P5Y6	17
P5Y8	17
P5Z1	15
P5Z3	16
P5Z7	16
P5Z8	16
P5Z9	16
PE-VPR	51
PEX0	51
PEX2	51, 53
PEX3	51
PEX4	53
PEX6	53
PEXB	51
PEXF	52
PEXL	51
PEXN	52
PEXP	51
PEXW	52
PEY2	54
PEY4	51
PEY5	51
PEY6	51

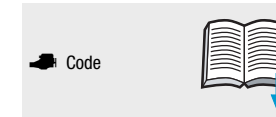

Code

PEY7	51
PN26	30
PN27	30
PN46	30
PN54	30
PN62	30
PY-VPS	70
PY-Y8	70
PY-ZA	70
PYY1	70
PYY3	70
PYZ4	71
PYZ8	72
PYZC	71
R	
R2	60
R203	60
R207	60
R21N	60
R281	60
R290	60
R2AA	60
R2BF	60
R5A2	61
RF	54
RF-N	54
RF1G	54
RF3F	55
RF4F	55
RF55	54
RF5C	56
RF7J	57
RF83	54
RF8G	57
RFG5	54
RFH5	54
RFH7	54
RZ4E-TC	40
S	
S5Y2	18
S5Y5	18
S5Y6	18
S5Y7	18

MAZDA



S5Y8	18
S5Y9	18
S8Y1	38
S8Y2	38
SH-VPTR	61
SH-VPTS	61
SHY1	62
SHY4	61
SHY6	61
SHY8	62-63

U

U	12
UC	12

W

WEAT	74
WL	69
WL-T	69
WL11	72
WL31	69
WL84	70
WLAA	72
WLE7	69
WLE9	69
WLF5	69

Y

Y404	12
Y406	27
Y601	27
Y603	27
Y605	27
Y642	27
Y646	27
Y650	27
Y655	27
Y661	27
Y6Y1	27
YF	57

Z

Z5-DE	19
Z6	28
Z601	29



Z627	29
Z668	28
Z682	28
Z683	28
Z6Y1	28
Z6Y3	28
ZJ-46	10
ZJ-VE	10
ZJ-VEM	10
ZJ07	10-11
ZJ30	11
ZJ32	11
ZJ46	10, 13
ZL05	18
ZL06	18
ZM	28
ZY-DE	19
ZY-VE	19
ZY05	19
ZY66	19
ZY84	19

MAZDA													
Ltr.													
1,1	B1 B116	40-42 kW (54-57 PS)	121 10/87-10/93										
1,1	E1	40-41 kW (54-56 PS)	323 11/80-04/90										
1,2	CR12DE	66 kW (90 PS)	FAMILIA VAN 01/07-05/18										
1,3	B3 B335	40-52 kW (55-71 PS)	121 323 09/85-06/91										

MAZDA

Ltr.  1,3 B3 44 kW (60 PS) 323  09/87-10/89  1



01-52420-02
8ABL-10-271

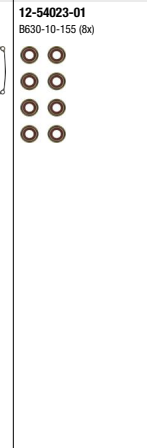
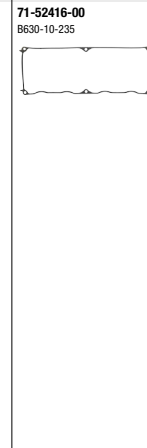
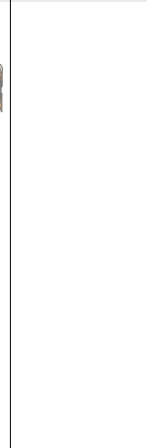
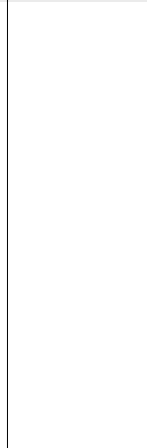
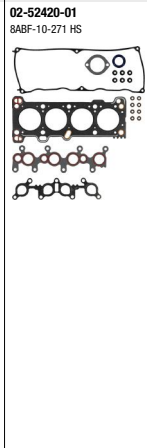
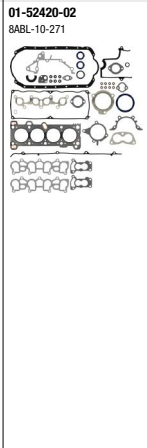

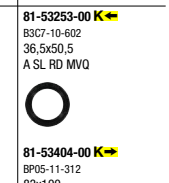
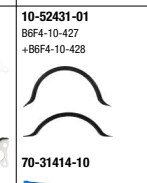
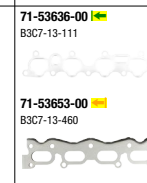
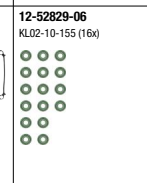
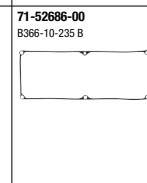
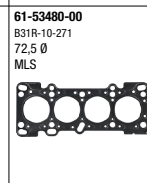
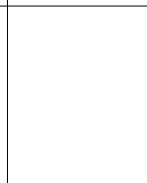

1,3 B3 ME B33G 46-54 kW (63-73 PS) DEMIO 323 08/98-07/03

01-53480-01
80DJ-10-271A



MAZDA

Ltr.  1,3 B3 ME 61 kW (83 PS) DEMIO  1  01/96-10/02

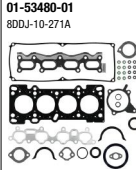

01-53480-01
8DDJ-10-271A

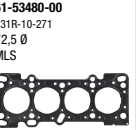
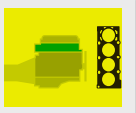

61-53480-00
B31R-10-271
72,5 Ø
MLS



71-52686-00
B366-10-235 B

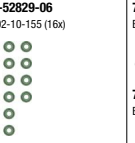

12-52829-06
KL02-10-155 (16x)

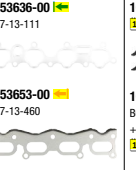
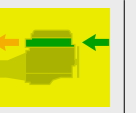

71-53636-00 
B3C7-13-111

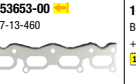

71-53653-00 
B3C7-13-460

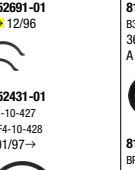

10-52691-01
 12/96

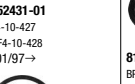

10-52431-01
B6F4-10-427
+B6F4-10-428
 01/97→



70-31414-10

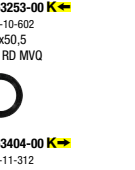
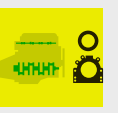

81-53253-00 
B3C7-10-602
36,5x50,5
A SL RD MVQ

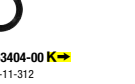

81-53404-00 
BP05-11-312
83x100
A SL LD MVQ



81-53228-00 
B630-10-602
30x44
A SL RD NBR

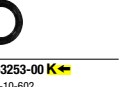

1,3 B3 (16V) 53 kW (72 PS) 323  01/01-05/04

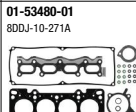

01-53480-01
8DDJ-10-271A

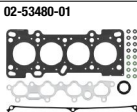

02-53480-01

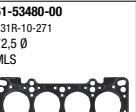

61-53480-00
B31R-10-271
72,5 Ø
MLS

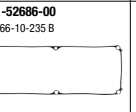

71-52686-00
B366-10-235 B

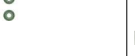
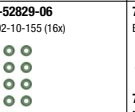

12-52829-06
KL02-10-155 (16x)



71-53636-00 
B3C7-13-111

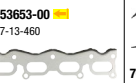

71-53653-00 
B3C7-13-460

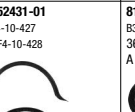

10-52431-01
B6F4-10-427
+B6F4-10-428



70-31414-10

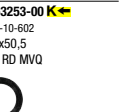

81-53253-00 
B3C7-10-602
36,5x50,5
A SL RD MVQ





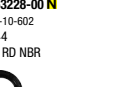



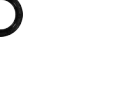

















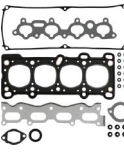
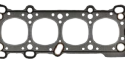









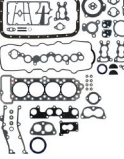





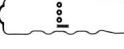







81-53404-00 
BP05-11-312
83x100
A SL LD MVQ



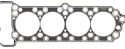





















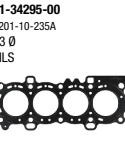

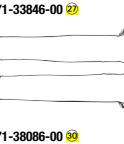

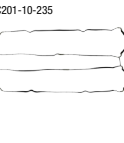
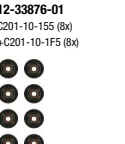

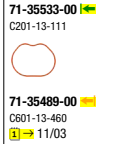

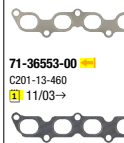







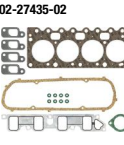



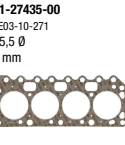
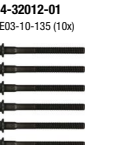



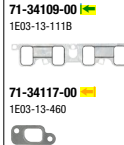







81-53228-00 
B630-10-602
30x44
A SL RD NBR

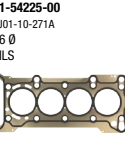
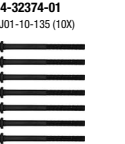
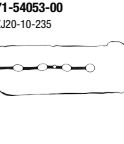
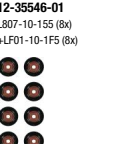

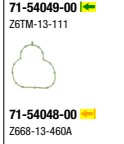
MAZDA

<p>Ltr.   </p>	<p>1,3 B3E B383</p> <p>49-50 kW (67-68 PS)</p>											
<p>01-52677-01 8CB6-10-271</p> 	<p>02-52677-01 8CB6-10-235</p> 	<p>61-52677-00 B3F2-10-271A 72,9 Ø</p> 	<p>71-52686-00 B366-10-235 B</p> 	<p>12-52829-01 B660-10-155 (16x)</p> 	<p>71-53653-00 B3C7-13-460</p> 	<p>10-52691-01</p>  <p>70-31414-10</p> 	<p>81-53253-00 K↔ B3C7-10-602 36,5x50,5 A SL RD MVQ</p>  <p>81-53404-00 K↔ BP05-11-312 83x100 A SL LD MVQ</p>  <p>81-53228-00 N B630-10-602 30x44 A SL RD NBR</p> 					
<p>1,3 E3</p> <p>44-50 kW (60-68 PS)</p> <p>323</p> <p>11/80-10/89</p>	<p>01-52265-05 8AB5-10-271  01/85→</p> 	<p>02-52265-04 E5A1-99-100 AHS  12/82→  12/84</p>  <p>02-52265-05 8AB5-10-271 HS  01/85→</p> 	<p>61-52265-20 E580-10-271 B 79 Ø</p> 	<p>15-52259-01</p> 	<p>12-52722-01 RF01-10-F155F (8x)</p> 	<p>71-52419-00 K↔ E5A1-13-111 A  12/82→  12/84</p>  <p>71-52419-00 K↔ E563-13-111 A  01/85→</p> <p>71-52264-00 K↔ E301-13-510A</p> 	<p>71-52257-00 E301-23-099</p> 	<p>81-53272-00 K↔ 0187-10-507B 40x55 A SL RD MVQ</p>  <p>81-53304-00 K↔ 0370-11-399 70x88 A SL LD MVQ</p> 				
<p>1,3 E3</p> <p>44-50 kW (60-68 PS)</p> <p>323</p> <p>08/85-04/90</p>	<p>01-52265-05 8AB5-10-271</p> 	<p>02-52265-05 8AB5-10-271 HS</p> 	<p>61-52265-20 E580-10-271 B 79 Ø</p> 	<p>15-52259-01</p> 	<p>12-52722-01 RF01-10-F155F (8x)</p> 	<p>71-52419-00 K↔ E563-13-111 A</p> <p>71-52264-00 K↔ E301-13-510A</p> 	<p>71-52257-00 E301-23-099</p> 	<p>81-53272-00 K↔ 0187-10-507B 40x55 A SL RD MVQ</p>  <p>81-53304-00 K↔ 0370-11-399 70x88 A SL LD MVQ</p> 				

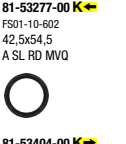
MAZDA













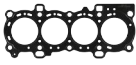









<p>Ltr.  1,3 FUJA</p>	<p>55 kW (75 PS)</p>	<p>DEMI 2</p>	<p>02/03-06/07</p>									<p>1,3 FUJA 55 kW (75 PS) DEMI 2 02/03-06/07</p>		<p>02-34295-02</p> 	<p>08-35006-01</p> 		<p>61-34295-00 C201-10-235A 73 Ø MLS</p> 	<p>14-32358-01 C605-10-135</p> 	<p>71-33846-00 </p>  <p>71-38086-00 </p> 	<p>12-33876-01 C201-10-155 (8x) +C201-10-1F5 (8x)</p> 	<p>71-35489-00 </p>  <p>71-36553-00 </p> 	<p>70-31414-10</p> 	<p>81-33869-00 </p>  <p>81-90011-00 </p>  <p>81-33871-00 </p> 
<p>1,3 JJA 37-44 kW (50-60 PS)</p> <p>1E04(JJA) 1E04(JJC) 1E04(JJM) 1E04(J4C) 1E04(J4J) 1E09(JJA) 1E09(JJC) 1E09(JJM) 1E09(J4C) 1E09(J4J) 1E13(JJA) 1E13(JJC) 1E13(JJM) 1E13(J4C) 1E13(J4J)</p>		<p>02-27435-02</p> 	<p>08-13052-01 </p>  <p>08-34118-01</p> 		<p>61-27435-00 1E03-10-271 75,5 Ø 1 mm</p> 	<p>14-32012-01 1E03-10-135 (10x)</p> 	<p>71-12963-10 1E03-10-235</p> 	<p>12-28238-01 1E03-10-155 (8x)</p>  <p>70-28238-00 1E03-10-155</p> 	<p>71-34109-00 </p>  <p>71-34117-00 </p> 	<p>10-13052-01 </p>  <p>71-34118-00 1E03-10-431</p> 	<p>81-34122-00 </p>  <p>81-34123-00 </p> 												
<p>1,3 ZJ-VE ZJ-VE ZJ07 ZJ-46 ZJ46</p>	<p>55-67 kW (75-91 PS)</p>	<p>2</p>	<p>07/07-06/15</p>	<p>01-54225-02 8LB4-10-271B</p> 	<p>61-54225-00 ZJ01-10-271A 76 Ø MLS</p> 	<p>14-32374-01 ZJ01-10-135 (10X)</p> 	<p>71-54053-00 ZJ20-10-235</p> 	<p>12-35546-01 L807-10-155 (8x) +LF01-10-1F5 (8x)</p> 	<p>71-54049-00 </p>  <p>71-54048-00 </p> 	<p>70-31414-10</p> 	<p>81-53277-00 </p>  <p>81-53404-00 </p> 												

MAZDA

Ltr.  1,4 FXJA 59 kW (80 PS) DEMIO 2 02/03-06/07













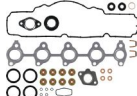















1,4 FXJA 59 kW (80 PS) DEMIO 2 02/03-06/07

	<p>02-36400-02 </p>	<p>08-36796-01 </p>		<p>61-36400-00 C401-10-271 77 Ø MLS </p>	<p>14-32358-01 C605-10-135 </p>	<p>71-33846-00  2  71-38086-00  2 C201-10-235 </p>	<p>12-33876-01 C201-10-155 (8x) +C201-10-1F5 (8x) </p>	<p>71-35533-00  4x C201-13-111  71-35489-00  1 C601-13-460  71-36553-00  1 C201-13-460 </p>	<p>70-31414-10 </p>	<p>81-33869-00  K C201-10-602 33x47 A SL RD FPM  81-90011-00  K C201-11-311 PTFE  81-33871-00  N 2x C201-10-231 38x52 A SL RD FPM </p>
--	------------------------------------------------------------------------------------------------------------------	-------------------------------------------------------------------------------------------------------------------	--	--------------------------------------------------------------------------------------------------------------------------------------------------------------------------------------------------------	-----------------------------------------------------------------------------------------------------------------------------------------------------	----------------------------------------------------------------------------------------------------------------------------------------------------------------------------------------------------------------------------------------------------------------------------------------------------------------------------------------------------------------------------------------------------------------------------------------------------------------	-------------------------------------------------------------------------------------------------------------------------------------------------------------------------------------------------	-------------------------------------------------------------------------------------------------------------------------------------------------------------------------------------------------------------------------------------------------------------------------------------------------------------------------------------------------------------------------------------------------------------------------------------------------------------------------------------------------------------------------------------------------------------------------------------------------------------------------------------------------------------------------------------------------------------------------------------------------	--------------------------------------------------------------------------------------------------------------------	------------------------------------------------------------------------------------------------------------------------------------------------------------------------------------------------------------------------------------------------------------------------------------------------------------------------------------------------------------------------------------------------------------------------------------------------------------------------------------------------------------------------------------------------------------------------------------------------------------------------------------------------------------------------------------------------------------------------------------------------------------------------------------------------------------------------------------------------------------------------------------------------------------

1,4 F1F6 44 kW (60 PS) 121 07/96-10/02

	<p>61-27335-20 80 Ø 1,75 mm </p>		<p>71-13031-10 </p>	<p>70-31056-00 </p>	<p>71-26979-00 </p>	
--	---------------------------------------------------------------------------------------------------------------------------------------------------------------------------	--	--------------------------------------------------------------------------------------------------------------------	--------------------------------------------------------------------------------------------------------------------	--------------------------------------------------------------------------------------------------------------------	--

1,4 F6JA F6JB Y404 50 kW (68 PS) 2 04/03-06/15

<p>02-35542-01 </p>	<p>08-36869-01 </p>	<p>04-10081-01  1 </p>	<p>61-35430-00 Y401-10-271 75 Ø 1,25 mm MLS 2  61-35430-10 Y401-10-272 75 Ø 1,3 mm MLS 3  61-35430-20 Y401-10-273 75 Ø 1,35 mm MLS 1  61-35430-30 Y401-10-274 75 Ø 1,4 mm MLS 4  61-35430-40 Y401-10-2H1 75 Ø 1,45 mm MLS 5  </p>	<p>14-32206-01 Y601-10-135A (10x) </p>	<p>15-35542-01 Y401-10-235 +Y401-13-113 (4x) +Y401-10-219 (2x)  71-35542-00 Y401-10-235 </p>	<p>12-35548-01 Y401-10-155 (8x)  70-35548-00 Y401-10-155 </p>	<p>40-76246-00  4x Y401-13-113  71-35487-00  1 Y401-13-460  8x</p>	<p>70-31414-10 </p>	<p>81-35554-00  K Y401-10-602 40x55 A SL RD PTFE ACM  81-35553-00  K Y401-11-312 85x105 A SL LD PTFE ACM  81-35552-00  N Y401-12-602 27x47 A SL RD PTFE ACM </p>
------------------------------------------------------------------------------------------------------------------	-------------------------------------------------------------------------------------------------------------------	-----------------------------------------------------------------------------------------------------------------------------------------------------------------------------------------------------------------	------------------------------------------------------------------------------------------------------------------------------------------------------------------------------------------------------------------------------------------------------------------------------------------------------------------------------------------------------------------------------------------------------------------------------------------------------------------------------------------------------------------------------------------------------------------------------------------------------------------------------------------------------------------------------------------------------------------------------------------------------------------------------------------------------------------------------------------------------------------------------------------------------------------------------------------------------------------------------------------------------------------------------------------------------------------------------------------------------------------------------------------------------------------------------------------------------------------------------------------------------------------------------------------------	------------------------------------------------------------------------------------------------------------------------------------------------------------	--------------------------------------------------------------------------------------------------------------------------------------------------------------------------------------------------------------------------------------------------------------------------------------------------------------------------------------------------------------------------------------	-------------------------------------------------------------------------------------------------------------------------------------------------------------------------------------------------------------------------------------------------------------------------------------------------------------	--------------------------------------------------------------------------------------------------------------------------------------------------------------------------------------------------------------------------------------------------------------------------------------------------------------------------------------------------------------------------------------------------------------------------------------------------------------------------------------------------------------------------	--------------------------------------------------------------------------------------------------------------------	---------------------------------------------------------------------------------------------------------------------------------------------------------------------------------------------------------------------------------------------------------------------------------------------------------------------------------------------------------------------------------------------------------------------------------------------------------------------------------------------------------------------------------------------------------------------------------------------------------------------------------------------------------------------------------------------------------------------------------------------------------------------------------------------------------------------------------------------------------------------------------------------------------------------------------------------------------













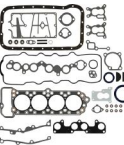
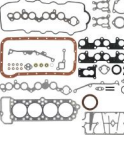

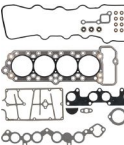
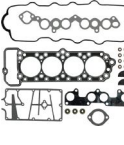







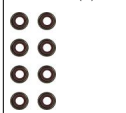











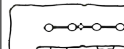





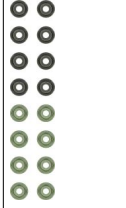

1,4 U UC 51 kW (69 PS) 323 05/78-08/82

	<p>61-52270-00 8569-10-271 A 79 Ø </p>	
--	-----------------------------------------------------------------------------------------------------------------------------------------------------------------------------------	--

MAZDA															
Ltr.															
1,4	ZJ46	55-63 kW (75-86 PS)	2	10/07-06/15	01-54225-02 8LB4-10-271B 				61-54225-00 ZJ01-10-271A 76 Ø MLS 	14-32374-01 ZJ01-10-135 (10X) 	71-54053-00 ZJ20-10-235 	12-35546-01 L807-10-155 (8x) +LF01-10-1F5 (8x) 	71-54049-00 4x Z6TM-13-111 71-54048-00 Z668-13-460A 	70-31414-10 	81-53277-00 FS01-10-602 42,5x54,5 A SL RD MVQ 81-53404-00 BP05-11-312 83x100 A SL LD MVQ
1,5	B5 B50 B53	54-55 kW (73-75 PS)	323	05/86-09/91	01-52422-03 8ABS-10-271 	02-52422-03 			61-52422-00 B621-10-271 A 80 Ø 		71-52416-00 B630-10-235 	12-54023-01 B630-10-155 (8x) 70-54023-00 B630-10-155 	71-52683-00 2x B501-13-111 71-52424-00 B630-13-460 A 	71-52417-00 B630-10-431 A 	81-53228-00 B630-10-602 30x44 A SL RD NBR 81-53404-00 BP05-11-312 83x100 A SL LD MVQ 81-53228-00 B630-10-602 30x44 A SL RD NBR
1,5	B5	55 kW (75 PS)	DEMIO	04/00-07/03	01-53445-01 8HBW-10-271 	02-53445-01 			61-53445-00 B5C7-10-271 79,5 Ø MLS 		71-52686-00 B366-10-235 B 	12-52829-06 KL02-10-155 (16x) 70-54282-00 KL02-10-155 	71-53519-00 B34M-13-111 71-53653-00 B3C7-13-460 	10-52431-01 B6F4-10-427 +B6F4-10-428 	81-53253-00 B3C7-10-602 36,5x50,5 A SL RD MVQ 81-53404-00 BP05-11-312 83x100 A SL LD MVQ 81-53228-00 B630-10-602 30x44 A SL RD NBR

MAZDA															
Ltr.															
1,5 E5 E5E2 E5E3	47-85 kW (64-115 PS)	E Kasten 323	07/84-05/89 1		02-52265-06 8AB3-10-271 HS 				61-52265-10 E5D7-10-271 79 0 		15-52259-01 	12-52722-01 RF01-10-F155F (8x) 	71-52418-00 ESA1-13-111 A 71-52421-00 ESB6-13-510 A 	71-52257-00 E301-23-099 	81-53272-00 0187-10-507B 40x55 A SL RD MVQ 81-53304-00 0370-11-399 70x88 A SL LD MVQ
1,5 E5	53-85 kW (72-88 PS)	323	11/80-12/85	01-52265-01 E580-99-100 D 11/82 01-52265-04 ESA1-99-100 A 12/82→ 	02-52265-02 E580-99-101 11/82 02-52265-04 ESA1-99-100 AHS 12/82→ 12/84 02-52265-06 8AB3-10-271 HS 01/85→ 			61-52265-20 E580-10-271 B 79 0 12/84 61-52265-10 E5D7-10-271 79 0 01/85→ 		15-52259-01 	12-52722-01 RF01-10-F155F (8x) 	71-52258-00 E331-40-581 B 11/82 71-52418-00 ESA1-13-111 A 12/82→ 71-52264-00 E301-13-510A 12/84 71-52421-00 ESB6-13-510 A 01/85→ 	71-52257-00 E301-23-099 	81-53272-00 0187-10-507B 40x55 A SL RD MVQ 81-53304-00 0370-11-399 70x88 A SL LD MVQ 	

















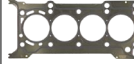

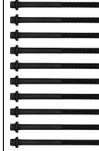



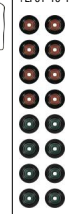

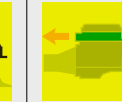



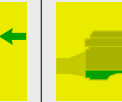





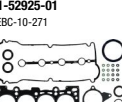

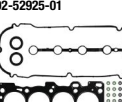
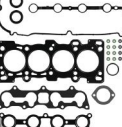
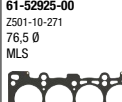

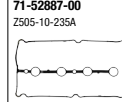
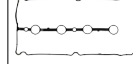
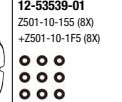

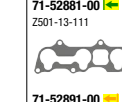



MAZDA

<p>Ltr. </p>	<p>1,5 E5</p>	<p>63 kW (86 PS)</p>	<p>323</p>	<p>11/80-12/83</p>		<p>01-52265-01 E580-99-100 D 11/82</p>		<p>01-52265-04 ESA1-99-100 A 12/82→</p>			<p>02-52265-02 E580-99-101 11/82</p>		<p>02-52265-04 ESA1-99-100 AHS 12/82→</p>											<p>61-52265-20 E580-10-271 B 79 0</p>									<p>15-52259-01</p>					<p>12-52722-01 RF01-10-F155F (8x)</p>					<p>71-52258-00 K E331-40-581 B 11/82</p>		<p>71-52418-00 K ESA1-13-111 A 12/82→</p>		<p>71-52264-00 K E301-13-510A</p>			<p>71-52257-00 E301-23-099</p>					<p>81-53272-00 K 0187-10-507B 40x55 A SL RD MVQ</p>		<p>81-53304-00 K 0370-11-399 70x88 A SL LD MVQ</p>	
<p>1,5 HR15DE</p>	<p>82 kW (111 PS)</p>	<p>FAMILIA VAN</p>	<p>01/07-05/18</p>																			<p>61-37855-00 78,5 0 MLS</p>			<p>14-17517-02</p>				<p>71-40612-00</p>			<p>12-40616-01</p>		<p>70-40616-00 16x</p>		<p>71-11415-00 K 4x</p>		<p>71-40609-00 K</p>		<p>70-31414-10</p>		<p>81-10451-00 K 42x52 A SL FPM</p>		<p>81-54111-00 K 84,2x117,22 A SL LD FPM</p>														
<p>1,5 P5-VPR P5Z1</p>	<p>96 kW (131 PS)</p>	<p>MX-5</p>	<p>06/15</p>	<p>01-10177-01 8LN7-10-271</p>												<p>61-10177-00 P51B-10-271 76 0 MLS</p>			<p>14-12063-01 P301-10-13S (10x)</p>				<p>71-12120-00 P51B-10-235</p>			<p>12-10138-01 PE01-10-155 (8x) +PE01-10-1F5 (8x)</p>		<p>70-10138-00 8x PE01-10-155</p>		<p>70-10139-00 8x PE01-10-1F5</p>		<p>71-12115-00 K 4x P301-13-111</p>		<p>71-12067-00 K P540-13-460</p>		<p>70-31414-10</p>		<p>81-10380-00 K PE01-10-602 43x56 A SL RD FPM</p>		<p>81-10381-00 K PE01-11-312 82x98 A SL LD FPM</p>																		

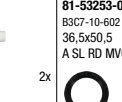

MAZDA															
Ltr.															
1,5 P5XB P5XC P5X0 P5X2 P5X4 P5X5 P5Z3 P5Z7 P5Z8 P5Z9	55-88 kW (75-120 PS)	2 3	09/13	01-10176-03 8P51-10-271A 					61-10176-00 P501-10-271A 76 Ø MLS 	14-12063-01 P301-10-135 (10x) 	71-12122-00 P301-10-235 	12-10138-01 PE01-10-155 (8X) +PE01-10-1F5 (8X) 70-10138-00 PE01-10-155 8x 70-10139-00 PE01-10-1F5 8x 	71-12115-00 4x P301-13-111 71-12064-00 P302-13-460 	70-31414-10 	81-10380-00 PE01-10-602 43x56 A SL RD FPM 81-10381-00 PE01-11-312 82x98 A SL LD FPM
1,5 P5X1	97 kW (132 PS)	MX-5	05/18	01-10177-02 8P52-10-271					61-10177-00 P51B-10-271 76 Ø MLS 	14-12063-01 P301-10-135 (10x) 	71-12120-00 P51B-10-235 	12-10138-01 PE01-10-155 (8X) +PE01-10-1F5 (8X) 70-10138-00 PE01-10-155 8x 70-10139-00 PE01-10-1F5 8x 	71-12115-00 4x P301-13-111 71-12067-00 P540-13-460 	70-31414-10 	81-10380-00 PE01-10-602 43x56 A SL RD FPM 81-10381-00 PE01-11-312 82x98 A SL LD FPM























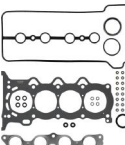



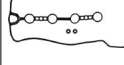
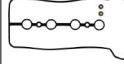
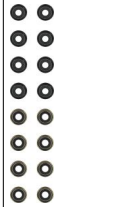

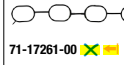

MAZDA															
1.5	PSY1	74-88 kW (100-120 PS)	3	09/13-05/19	01-10176-01 8LAD-10-271 				61-10176-00 P501-10-271A 76 Ø MLS 	14-12063-01 P301-10-135 (10x) 	71-12122-00 P301-10-235 	12-10138-01 PE01-10-155 (8X) +PE01-10-1F5 (8X) 8x 70-10138-00 PE01-10-155 8x 70-10139-00 PE01-10-1F5 8x	71-12115-00 4x P301-13-111 71-12064-00 P302-13-460 	70-31414-10 	81-10380-00 PE01-10-602 43x56 A SL RD FPM 81-10381-00 PE01-11-312 82x98 A SL LD FPM
1.5	PSY4 PSY5 PSY6 PSY8	55-88 kW (75-120 PS)	2 3	09/13	01-10176-01 8LAD-10-271 01-10176-02 				61-10176-00 P501-10-271A 76 Ø MLS 	14-12063-01 P301-10-135 (10x) 	71-12122-00 P301-10-235 71-12253-00 P51R-10-235 	12-10138-01 PE01-10-155 (8X) +PE01-10-1F5 (8X) 8x 70-10138-00 PE01-10-155 8x 70-10139-00 PE01-10-1F5 8x	71-12115-00 4x P301-13-111 71-12064-00 P302-13-460 	70-31414-10 	81-10380-00 PE01-10-602 43x56 A SL RD FPM 81-10381-00 PE01-11-312 82x98 A SL LD FPM

MAZDA











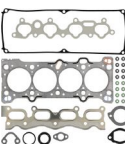
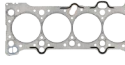
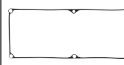

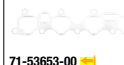
Ltr.	Engine	Power	Model	Year	Part 1	Part 2	Part 3	Part 4	Part 5	Part 6	Part 7	Part 8	Part 9	Part 10	Part 11
1,5	ZY-DE ZY-VE ZY05 ZY66 ZY84	75-84 kW (102-114 PS)	VERISA	02/03-06/15	 01-54045-02 8LBU-10-271 				 61-54045-00 ZY01-10-271A 80 Ø MLS 	 14-32374-01 ZJ01-10-135 (10X) 	 71-54053-00 ZJ20-10-235 	 12-35546-01 L807-10-155 (8x) +LF01-10-1F5 (8x)  70-35544-00 LF01-10-1F5 8x  70-35546-00 L807-10-155 8x 	 71-54049-00  4x Z6TM-13-111  71-54048-00  Z668-13-460A 	 70-31414-10 	 81-53277-00  F801-10-602 42,5x54,5 A SL RD MVQ  81-53404-00  BP05-11-312 83x100 A SL LD MVQ 
1,5	Z5-DE	65-66 kW (88-90 PS)	323	05/94-12/98	 01-52925-01 8EBC-10-271 	 02-52925-01 			 61-52925-00 Z501-10-271 76,5 Ø MLS 		 71-52887-00 Z505-10-235A 	 12-53539-01 Z501-10-155 (8X) +Z501-10-1F5 (8X)  71-52891-00 Z501-13-460 	 71-52881-00  Z501-13-111  71-52891-00  Z501-13-460 	 70-31414-10  71-52867-00 2x 	 81-53253-00  B3C7-10-602 36,5x50,5 A SL RD MVQ  81-53404-00  BP05-11-312 83x100 A SL LD MVQ  81-53243-00  F801-10-602 34x48 A SL RD MVQ 

MAZDA















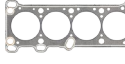



Ltr.  1.5 1N2-FE 76-80 kW (103-109 PS) FAMILIA VAN  06/18 

										
<p>01-53135-01</p>  <p>01-53135-04</p> 	<p>02-53135-01</p>  <p>02-53135-05</p> 			<p>61-53135-10 75,5 Ø 0,5 mm MLS</p> 	<p>14-55033-01</p> 	<p>15-17260-01 </p>  <p>15-53088-01</p> 	<p>12-53093-01</p>  <p>70-53093-00 ES 8x</p>  <p>70-54062-00 AS 8x</p> 	<p>71-53089-00 </p>  <p>71-17261-00  </p>  <p>71-53091-00 </p> 	<p>70-31414-10</p> 	<p>81-53218-00 </p> <p>25,5x37,5 A SL RD NBR</p>  <p>81-53313-00 </p> <p>75x107 A SL LD MVQ</p> 

1,6 B6 B67J B67K B67L 65-66 kW (88-90 PS) MX-3 323 08/89-09/00























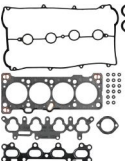
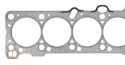

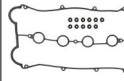





<p>01-53485-01 8CBY-10-271</p> 	<p>02-53485-01 8CBY-10-235</p> 			<p>61-53485-00 B64D-10-271A 79,5 Ø 1,3 mm</p> 		<p>71-52686-00 B366-10-235 B</p> 	<p>12-52829-01 B660-10-155 (16x)</p> 	<p>71-53636-00 </p> <p>B3C7-13-111</p>  <p>71-53653-00 </p> <p>B3C7-13-460</p> 	<p>10-52431-01 B6F4-10-427 +B6F4-10-428</p>  <p>70-31414-10</p> 	<p>81-53253-00 </p> <p>B3C7-10-602 36,5x50,5 A SL RD MVQ</p>  <p>81-53404-00 </p> <p>BP05-11-312 83x100 A SL LD MVQ</p>  <p>81-53228-00 </p> <p>B630-10-602 30x44 A SL RD NBR</p> 
----------------------------------------------------------------------------------------------------------------------	----------------------------------------------------------------------------------------------------------------------	--	--	-----------------------------------------------------------------------------------------------------------------------------------------------	--	--------------------------------------------------------------------------------------------------------------------------	------------------------------------------------------------------------------------------------------------------------------	-----------------------------------------------------------------------------------------------------------------------------------------------------------------------------------------------------------------------------------------------------------------------------------------------------------------------------------------------------------------------------------------------------------------------------	------------------------------------------------------------------------------------------------------------------------------------------------------------------------------------------------------------------------------------------------	-------------------------------------------------------------------------------------------------------------------------------------------------------------------------------------------------------------------------------------------------------------------------------------------------------------------------------------------------------------------------------------------------------------------------------------------------------------------------------------------------------------------------------------------------------------------------------------------------------------------------------------------------------------------------------------------------------------------------------

1,6 B6 (SOHC) B65L B68 54-77 kW (73-105 PS) 323 08/85











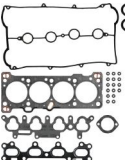

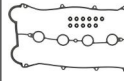

<p>01-52422-01 8AB7-10-271  12/87</p>  <p>01-52422-02 8ABT-10-271 A  01/88 →</p>	<p>02-52422-01 8AB1-10-235</p> 			<p>61-52422-00 B621-10-271 A 80 Ø</p> 		<p>71-52416-00 B630-10-235</p> 	<p>12-54023-01 B630-10-155 (8x)</p>  <p>70-54023-00 8x</p> 	<p>71-52423-00 </p> <p>B630-13-111</p>  <p>71-52424-00 </p> <p>B630-13-460 A</p> 	<p>71-52417-00 B630-10-431 A</p> 	<p>81-53228-00 </p> <p>B630-10-602 30x44 A SL RD NBR</p>  <p>81-53404-00 </p> <p>BP05-11-312 83x100 A SL LD MVQ</p>  <p>81-53228-00 </p> <p>B630-10-602 30x44 A SL RD NBR</p> 
-----------------------------------------------------------------------------------------------------------------------------------------------------------------------------------------------------------------------------------------------------------------------------------------------------------------------------------------------------------	------------------------------------------------------------------------------------------------------------------------	--	--	-------------------------------------------------------------------------------------------------------------------------------------	--	--------------------------------------------------------------------------------------------------------------------------	-------------------------------------------------------------------------------------------------------------------------------------------------------------------------------------------------------------------------------------------	---------------------------------------------------------------------------------------------------------------------------------------------------------------------------------------------------------------------------------------------------------------------------------------------------------------------------------------------------------------------------------------------------------------------------------------	----------------------------------------------------------------------------------------------------------------------------	--------------------------------------------------------------------------------------------------------------------------------------------------------------------------------------------------------------------------------------------------------------------------------------------------------------------------------------------------------------------------------------------------------------------------------------------------------------------------------------------------------------------------------------------------------------------------------------------------------------------------------------------------------------------------------------------------------------------------------------

MAZDA

Ltr.  1,6 B6 Turbo 103 kW (140 PS) 323  1 10/85-08/93

										
<p>01-52425-06 8ABD-10-271</p> 	<p>02-52425-02 8AB3-10-235</p> 			<p>61-52425-00 B6F4-10-271 B 79,5 Ø</p> 	<p>14-55074-01 B660-10-135A (10x)</p> 	<p>15-52432-01 B660-10-235A</p> 	<p>12-52829-01 B660-10-155 (16x)</p> 	<p>71-52429-00 </p> <p>BJ01-13-111</p> 	<p>10-52431-01 B6F4-10-427 +B6F4-10-428  04/87→</p>  <p>71-52417-00 B630-10-431 A  03/87</p>  <p>70-31414-10  04/87→</p> 	<p>81-53228-00 </p> <p>B630-10-602 30x44 A SL RD NBR</p>  <p>81-53404-00 </p> <p>BP05-11-312 83x100 A SL LD MVQ</p>  <p>81-53243-00 </p> <p>F801-10-602 34x48 A SL RD MVQ</p> 

1,6 B6 Turbo 103 kW (140 PS) 323 10/87-11/91

<p>01-52425-06 8ABD-10-271</p> 	<p>02-52425-02 8AB3-10-235</p> 			<p>61-52425-00 B6F4-10-271 B 79,5 Ø</p> 	<p>14-55074-01 B660-10-135A (10x)</p> 	<p>15-52432-01 B660-10-235A</p> 	<p>12-52829-01 B660-10-155 (16x)</p> 	<p>71-52429-00 </p> <p>BJ01-13-111</p> 	<p>10-52431-01 B6F4-10-427 +B6F4-10-428</p>  <p>70-31414-10</p> 	<p>81-53228-00 </p> <p>B630-10-602 30x44 A SL RD NBR</p>  <p>81-53404-00 </p> <p>BP05-11-312 83x100 A SL LD MVQ</p>  <p>81-53243-00 </p> <p>F801-10-602 34x48 A SL RD MVQ</p> 
-----------------------------------------------------------------------------------------------------------------------------	-----------------------------------------------------------------------------------------------------------------------------	--	--	--------------------------------------------------------------------------------------------------------------------------------------------	--------------------------------------------------------------------------------------------------------------------------------------	--------------------------------------------------------------------------------------------------------------------------------	-------------------------------------------------------------------------------------------------------------------------------------	----------------------------------------------------------------------------------------------------------------------------------------------------------------------------------------------------------------------	--------------------------------------------------------------------------------------------------------------------------------------------------------------------------------------------------------------------------------------------------------------	-------------------------------------------------------------------------------------------------------------------------------------------------------------------------------------------------------------------------------------------------------------------------------------------------------------------------------------------------------------------------------------------------------------------------------------------------------------------------------------------------------------------------------------------------------------------------------------------------------------------------------------------------------------------------------------------------------------------------------------------------

MAZDA

Ltr.  1,6 B6DA D6DK 79-81 kW (107-110 PS) MX-3 323  11/93-09/98

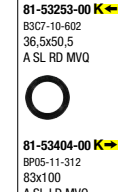
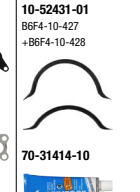
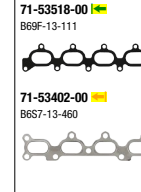
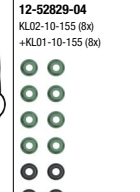
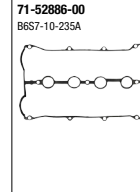
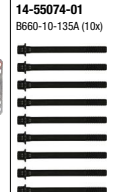
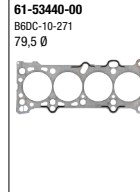
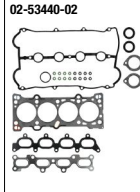

1,6 B6E 62-63 kW (84-86 PS) 323 09/86-10/95

01-53440-02
8DC3-10-271

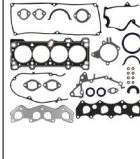

02-53440-02
8484-10-235



61-53440-00
B6DC-10-271
79,5 Ø

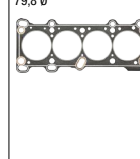

14-55074-01
B660-10-135A (10x)



71-52886-00
B6S7-10-235A

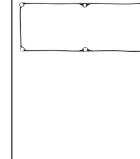

12-52829-04
KL02-10-155 (8x)
+KL01-10-155 (8x)

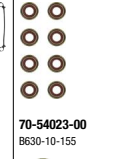

71-53518-00 
B69F-13-111



10-52431-01
B6F4-10-427
+B6F4-10-428



81-53253-00 
B3C7-10-602
36,5x50,5
A SL RD MVQ

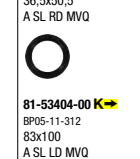

81-53404-00 
BP05-11-312
83x100
A SL LD MVQ



81-53243-00 
F801-10-602
34x48
A SL RD MVQ



81-53228-00 
B630-10-602
30x44
A SL RD NBR



MAZDA

Ltr.   



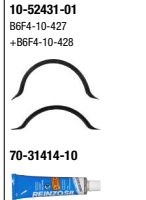
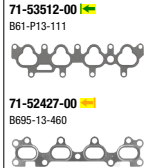
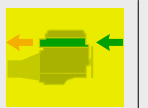
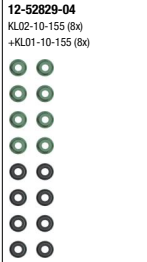
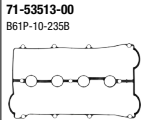
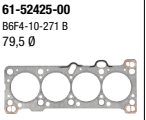
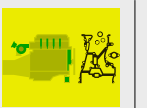
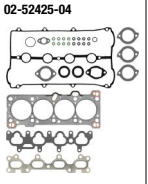
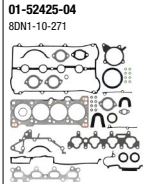



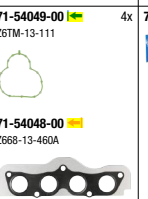
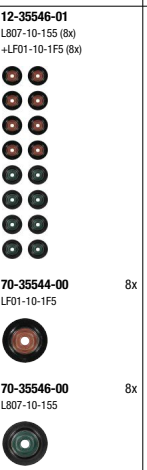
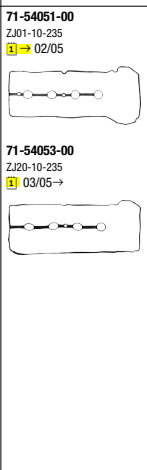
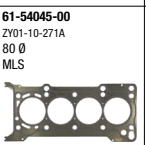
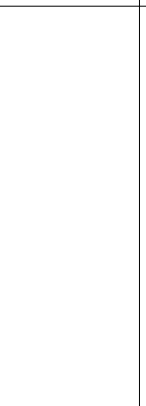

















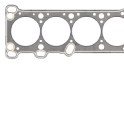



1,6 B6MC 66-85 kW (90-115 PS) MX-5 05/90-10/05
 B6MU
 B64F
 8AN1

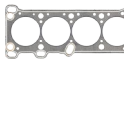

1,6 B6ZE 77-88 kW (104-120 PS)



MAZDA

<p>Ltr. </p>	<p>1,6 B65M</p>	<p>63 kW (86 PS)</p>	<p>323</p>	<p>09/86-10/95</p>	<p></p>	<p>01-52422-01 8AB7-10-271 12/87</p>	<p></p>	<p>01-52422-02 8ABT-10-271 A</p>	<p></p>	<p></p>	<p></p>	<p></p>	<p></p>	<p></p>	<p></p>	<p></p>	<p></p>	<p></p>
<p>1,6 B65M</p>	<p>63 kW (86 PS)</p>	<p>323</p>	<p>05/90-10/95</p>	<p>01-52422-02 8ABT-10-271 A</p>	<p></p>	<p>02-52422-01 8AB1-10-235</p>	<p></p>	<p>61-52422-00 B621-10-271 A 80 0</p>	<p></p>	<p>71-52416-00 B630-10-235</p>	<p></p>	<p>12-54023-01 B630-10-155 (8x)</p>	<p>71-52423-00  B630-13-111</p>	<p>71-52424-00  B630-13-460 A</p>	<p>71-52417-00 B630-10-431 A</p>	<p>81-53228-00  B630-10-602 30x44 A SL RD NBR</p>	<p>81-53404-00  BP05-11-312 83x100 A SL LD MVQ</p>	<p>81-53228-00 N B630-10-602 30x44 A SL RD NBR</p>
<p>1,6 B65M</p>	<p>63 kW (86 PS)</p>	<p>323</p>	<p>05/90-10/95</p>	<p>01-52422-02 8ABT-10-271 A</p>	<p></p>	<p>02-52422-01 8AB1-10-235</p>	<p></p>	<p>61-52422-00 B621-10-271 A 80 0</p>	<p></p>	<p>71-52416-00 B630-10-235</p>	<p></p>	<p>12-54023-01 B630-10-155 (8x)</p>	<p>71-52423-00  B630-13-111</p>	<p>71-52424-00  B630-13-460 A</p>	<p>71-52417-00 B630-10-431 A</p>	<p>81-53228-00  B630-10-602 30x44 A SL RD NBR</p>	<p>81-53404-00  BP05-11-312 83x100 A SL LD MVQ</p>	<p>81-53228-00 N B630-10-602 30x44 A SL RD NBR</p>

MAZDA

Ltr.  1,6 B68 54 kW (73 PS) 323  06/86-03/87  1



01-52422-01
8AB7-10-271



02-52422-01
8AB1-10-235



61-52422-00
B621-10-271 A
80 0

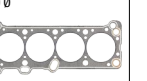

71-52416-00
B630-10-235



12-54023-01
B630-10-155 (8x)

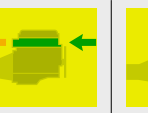
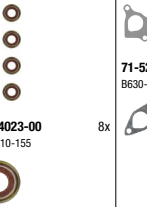

71-52423-00 
B630-13-111

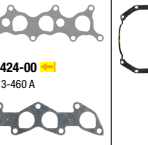

8x

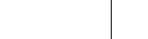

71-52424-00 
B630-13-460 A



71-52417-00
B630-10-431 A

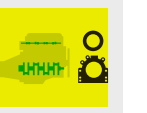

81-53228-00 
B630-10-602
30x44
A SL RD NBR



81-53404-00 
BP05-11-312
83x100
A SL LD MVQ



81-53228-00 **N**
B630-10-602
30x44
A SL RD NBR



1,6 B69N 83 kW (113 PS) XEDOS 01/92-03/94



14-55074-01
B660-10-135A (10x)

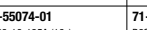

71-52886-00
B6S7-10-235A



12-52829-04
KL02-10-155 (8x)
+KL01-10-155 (8x)

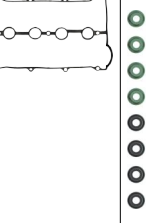

71-53518-00 
B69F-13-111



71-53402-00 
B6S7-13-460



10-52431-01
B6F4-10-427
+B6F4-10-428

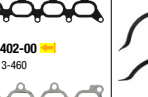

70-31414-10



81-53253-00 
83C7-10-602
36.5x50,5
A SL RD MVQ



81-53404-00 
BP05-11-312
83x100
A SL LD MVQ



81-53243-00 **N** 
F801-10-602
34x48
A SL RD MVQ



2x

MAZDA

Ltr. 1,6 FYJA 74 kW (100-101 PS) DEMIO 2 02/03-06/07

	<p>02-36405-02 09/03</p> <p>02-35930-02 10/03→</p>	<p>08-36796-01 </p>		<p>61-36405-00 C601-10-271A 80 Ø MLS 09/03</p> <p>61-35930-00 C601-10-271B 80 Ø MLS 10/03→</p>	<p>14-32358-01 C605-10-135 </p>	<p>71-33846-00 </p> <p>71-38086-00 </p>	<p>12-33876-01 C201-10-155 (8x) +C201-10-1F5 (8x) </p>	<p>71-35533-00 4x C201-13-111</p> <p>71-35489-00 C601-13-460 11/03</p> <p>71-36553-00 C201-13-460 12/03→</p>	<p>70-31414-10 </p>	<p>81-33869-00 K↔ C201-10-602 33x47 A SL RD FPM</p> <p>81-90011-00 K↔ C201-11-311 PTFE</p> <p>81-33871-00 N 2x C201-10-231 38x52 A SL RD FPM</p>		

1,6 F6 59-60 kW (80-82 PS) B-SERIE 626 11/82-03/96



<p>01-52267-01 F601-99-100 </p>	<p>02-52267-01 F601-99-101 </p>			<p>61-52267-00 F601-10-271 D 83 Ø </p>		<p>71-52269-10 F801-10-235 D </p>	<p>12-52722-01 RF01-10-F155F (8x) </p>	<p>71-52447-00 K↔ F801-13-111 A</p> <p>71-52444-00 F801-13-460 A</p>	<p>71-52023-00 0221-10-431 </p>	<p>81-53243-00 K↔ F801-10-602 34x48 A SL RD MVQ</p> <p>81-53341-10 K↔ F265-11-399 90x110 A SL LD FPM</p> <p>81-53243-00 N↔ F801-10-602 34x48 A SL RD MVQ</p>	

1,6 HR16DE 80 kW (109 PS) FAMILIA 01/07-05/18

<p>01-37855-01 </p>	<p>02-37855-01 </p>			<p>61-37855-00 78,5 Ø MLS </p>	<p>14-17517-02 </p>	<p>71-40612-00 </p>	<p>12-40616-01 </p>	<p>71-40611-00 K↔</p> <p>71-40609-00 </p>	<p>70-31414-10 </p>	<p>81-53692-00 K↔ 13510-ED000 40x52 SL RD FPM</p> <p>81-54111-00 K↔ 84,2x117,22 A SL LD FPM</p>

MAZDA														
Ltr.														
1,6	Y406 Y601 Y603 Y605 Y642 Y646	66-80 kW (90-109 PS)	2 3 3 CD 3 DI TURBO	06/04-06/15										
					02-36567-01 	08-36869-01 	04-10043-01	61-36265-00 Y601-10-271 76 Ø 1,25 mm MLS 	14-32206-01 Y601-10-135A (10x) 	71-36567-00 Y601-10-235 	12-36587-01 Y601-10-155 (16x) 	11-11022-01	70-31414-10 	81-35554-00 Y401-10-602 40x55 A SL RD PTFE ACM
								61-36265-10 Y601-10-272 76 Ø 1,3 mm MLS 			70-36587-00 Y601-10-155 	16x 	40-76240-00 Y601-10-238 4x 	81-35553-00 Y401-11-312 85x105 A SL LD PTFE ACM
								61-36265-20 Y601-10-273 76 Ø 1,35 mm MLS 					40-76919-00 Y601-13-113 4x 	81-35552-00 Y401-12-602 27x47 A SL RD PTFE ACM
								61-36265-30 Y601-10-274 76 Ø 1,4 mm MLS 					71-35487-00 Y401-13-460 	
								61-36265-40 Y601-10-2H1 76 Ø 1,45 mm MLS 						
1,6	Y6Y1 Y650 Y655 Y661	70-85 kW (95-116 PS)	2 3 5	07/10				61-37940-00 Y650-10-271 A 75,7 Ø 1,25 mm MLS 	14-32206-01 Y601-10-135A (10x) 	71-40903-00 Y650-10-235 	12-35548-01 Y401-10-155 (8x) 	71-38503-00 Y650-13-460 	70-31414-10 	81-35554-00 Y401-10-602 40x55 A SL RD PTFE ACM
								61-37940-10 Y650-10-272 B 75,7 Ø 1,3 mm MLS 			70-35548-00 Y401-10-155 	8x 		81-35553-00 Y401-11-312 85x105 A SL LD PTFE ACM
								61-37940-20 Y650-10-273 B 75,7 Ø 1,35 mm MLS 						81-35552-00 Y401-12-602 27x47 A SL RD PTFE ACM
								61-37940-30 Y650-10-274 B 75,7 Ø 1,4 mm MLS 						
								61-37940-40 Y650-10-2H1 B 75,7 Ø 1,45 mm MLS 						

MAZDA

Ltr.  1,6 ZM 70-78 kW (95-106 PS) 323   1 09/98-05/04

01-53450-02
8LB2-10-271A



02-53450-02

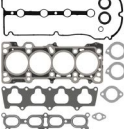



61-53450-00
ZL01-10-271A
79,5 Ø
0,3 mm
MLS





71-53521-00
ZL01-10-235



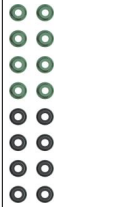

12-52829-04
KL02-10-155 (8x)
+KL01-10-155 (8x)

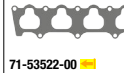

71-53523-00 
ZL01-13-111



71-53522-00 
ZL01-13-460



10-52431-01
B6F4-10-427
+B6F4-10-428



70-31414-10



81-53253-00 
B3C7-10-602
36,5x50,5
A SL RD MVQ



81-53404-00 
BP05-11-312
83x100
A SL LD MVQ



81-59000-00 
B366-11-310C



81-53243-00 
F801-10-602
34x48
A SL RD MVQ



1,6 Z6 77-85 kW (105-116 PS) 3 01/07-05/19

Z6Y1
Z6Y3
Z668
Z682
Z683

01-54045-02
8LBU-10-271



61-54045-00
ZY01-10-271A
80 Ø
MLS



14-32374-01
ZJ01-10-135 (10X)



71-54053-00
ZJ20-10-235

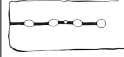

12-35546-01
L807-10-155 (8x)
+LF01-10-1F5 (8x)

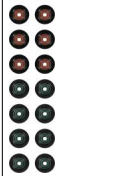



70-35544-00
LF01-10-1F5





70-35546-00
L807-10-155



71-54049-00 
Z6TM-13-111



71-54048-00 
Z668-13-460A



70-31414-10



81-53277-00 
FS01-10-602
42,5x54,5
A SL RD MVQ



81-53404-00 
BP05-11-312
83x100
A SL LD MVQ



MAZDA

Ltr.  1.6 Z601 Z627 77 kW (105 PS) 3 10/03-06/09 



01-54045-01
8LB9-10-271
 ⇒ 02/05



01-54045-02
8LBU-10-271
 ⇒ 03/05→

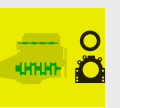

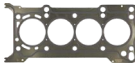

61-54045-00
ZY01-10-271A
80 0
MLS



14-32374-01
ZJ01-10-135 (10X)



71-54051-00
ZJ01-10-235
 ⇒ 02/05

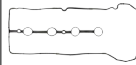

71-54053-00
ZJ20-10-235
 ⇒ 03/05→

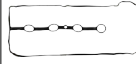

12-35546-01
L807-10-155 (8x)
+LF01-10-1F5 (8x)





70-35544-00
LF01-10-1F5





70-35546-00
L807-10-155



71-54049-00  4x
Z6TM-13-111





71-54048-00 
Z668-13-460A





70-31414-10



81-53277-00  
FS01-10-602
42,5x54,5
A SL RD MVQ



81-53404-00  
BP05-11-312
83x100
A SL LD MVQ



1,6 4G18 74 kW (101 PS)

01-53880-01



02-53880-01



61-53880-00
MLS

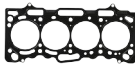

15-53166-01

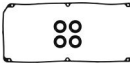

12-53908-01





70-53908-00 **ES**





70-53909-00 **AS**



71-53157-00  



71-53158-00  



70-31414-10



81-53227-00  
30x46
A SL RD MVQ
 ⇒ 08/02



81-53907-00  
34x46
A SL RD FPM
 ⇒ 09/02→













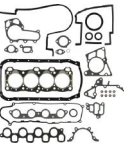
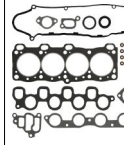

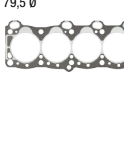







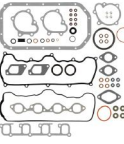
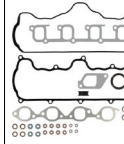

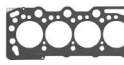

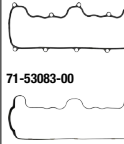

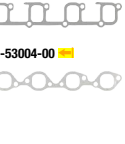

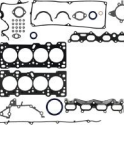
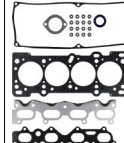

81-53306-00  
72x96
A SL LD MVQ

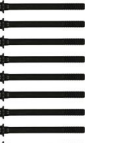
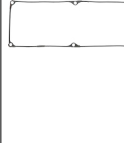

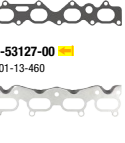























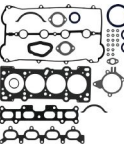
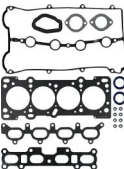

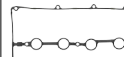















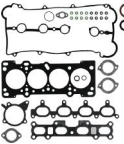

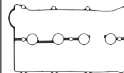





81-53246-00 **N**
35x50
A SL RD FPM



MAZDA

<p>Ltr. </p>	<p>40-42 kW (54-57 PS)</p>	<p>323 D</p>	<p>01/86-07/94</p>	<p>01-52430-02 8EB2-10-271</p> 	<p>02-52430-02 8EB2-10-235 A</p> 			<p>61-52430-00 PN11-10-271 B 79,5 Ø</p> 		<p>71-52433-00 PN11-10-235 A</p> 				<p>81-53228-00 K↔ B630-10-602 30x44 A SL RD NBR</p>  <p>81-53404-00 K↔ BP05-11-312 83x100 A SL LD MVQ</p>  <p>81-53228-00 N↔ B630-10-602 30x44 A SL RD NBR</p> 
<p>1,7 4EE1-T</p>	<p>60-65 kW (82-88 PS)</p>	<p>323 323 TD</p>	<p>05/94-09/98</p>	<p>01-52717-01</p> 	<p>02-52717-01</p> 		<p>61-52775-00 80,5 Ø 1,4 mm MLS</p> <p>61-52775-10 80,5 Ø 1,5 mm MLS</p> <p>61-52775-20 80,5 Ø 1,6 mm MLS</p> 	<p>14-32160-01</p> 	<p>71-52717-00</p>  <p>71-53083-00</p> 	<p>71-53003-00 K↔</p>  <p>71-53004-00 K↔</p> 	<p>71-53002-00</p> 	<p>81-53267-00 K↔ 40x52 A SL RD NBR</p>  <p>81-53299-00 K↔ 87x100 A SL LD FPM</p>  <p>81-53267-00 N↔ 40x52 A SL RD NBR</p> 		
<p>1,8 BP</p>	<p>76 kW (103 PS)</p>	<p>323</p>	<p>08/89-07/94</p>	<p>01-53125-01 8CB2-10-271A</p> 	<p>02-53125-01 8AB5-10-235</p> 		<p>61-53125-00 BP26-10-271 84,5 Ø MLS</p> 	<p>14-55074-01 B660-10-135A (10x)</p> 	<p>71-53124-00 BP01-10-235A</p> 	<p>12-52829-01 B660-10-155 (16x)</p> 	<p>71-53126-00 K↔ BP01-13-111</p>  <p>71-53127-00 K↔ BP01-13-460</p> 	<p>71-52866-00 B541-10-427 +B541-10-428</p> 	<p>81-53228-00 K↔ B630-10-602 30x44 A SL RD NBR</p>  <p>81-53404-00 K↔ BP05-11-312 83x100 A SL LD MVQ</p>  <p>81-53228-00 N↔ B630-10-602 30x44 A SL RD NBR</p> 	

MAZDA

Ltr.															
1,8	BP (DOHC) BP22 BP31 BP52	76-103 kW (103-140 PS)	323	06/89-05/04	01-52920-02 	02-52920-02 			61-52920-00 BP01-10-271 84,5 Ø MLS 	14-55074-01 B660-10-135A (10x) 	71-52871-00 BP05-10-235 	12-52829-01 B660-10-155 (16x) 	71-52863-00  BP05-13-111  71-52864-00  BP05-13-460 	71-52866-00 B541-10-427 +B541-10-428 	81-53253-00  B3C7-10-602 36,5x50,5 A SL RD MVQ  81-53404-00  BP05-11-312 83x100 A SL LD MVQ  81-53243-00  F801-10-602 34x48 A SL RD MVQ 
1,8	BPC	76 kW (103 PS)	323	01/91-04/94				61-52920-00 BP01-10-271 84,5 Ø MLS 		71-53124-00 BP01-10-235A 					
1,8	BPD BP-ZE BP6J	102-107 kW (139-146 PS)	MX-5	01/98-10/05	01-53455-01 80N5-10-271 	02-53455-01 		61-53455-00 BP6D-10-271 84,5 Ø 0,75 mm MLS 	14-55074-01 B660-10-135A (10x) 	71-53527-00 BP6D-10-235A 	12-52829-04 KL02-10-155 (8x) +KL01-10-155 (8x) 	71-53514-00  BP4W-13-111  71-53516-00  BP03-13-460 	10-52431-01 B6F4-10-427 +B6F4-10-428  70-31414-10 	81-53253-00  B3C7-10-602 36,5x50,5 A SL RD MVQ  81-53404-00  BP05-11-312 83x100 A SL LD MVQ  81-53243-00  F801-10-602 34x48 A SL RD MVQ  81-53526-00  ZL09-10-602 47x61 A SL RD MVQ 	

MAZDA

Ltr.  1.8 BPF1 BP-ZE 84-99 kW (114-135 PS) MX-5 323 09/92-10/98  1



01-53125-02
8DN3-10-271



02-53125-02
8AN3-10-235



61-53125-00
BP26-10-271
84,5 Ø
MLS

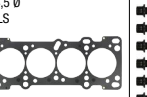

14-55074-01
B660-10-135A (10x)

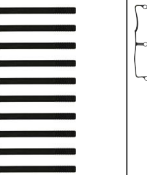

71-53517-00
BP05-10-235C

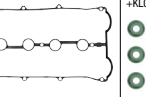

12-52829-04
KL02-10-155 (8x)
+KL01-10-155 (8x)

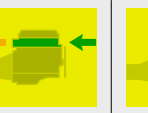
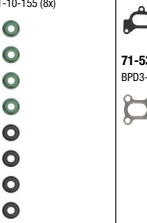

71-52863-00 
BP05-13-111

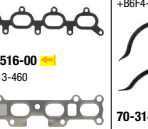

71-53516-00 
BPD3-13-460



10-52431-01
B6F4-10-427
+B6F4-10-428



70-31414-10

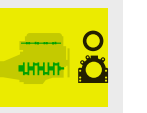



81-53253-00 
B3C7-10-602
36,5x50,5
A SL RD MVQ



81-53404-00 
BP05-11-312
83x100
A SL LD MVQ



81-53243-00  2x
F801-10-602
34x48
A SL RD MVQ



1.8 BP5A 103 kW (140 PS) MX-5 01/98-10/05

01-53125-02
8DN3-10-271



02-53125-02
8AN3-10-235



61-53125-00
BP26-10-271
84,5 Ø
MLS

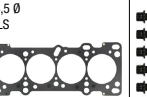

14-55074-01
B660-10-135A (10x)

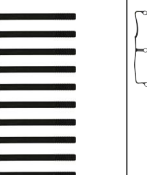

71-53517-00
BP05-10-235C

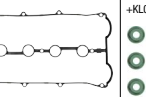

12-52829-04
KL02-10-155 (8x)
+KL01-10-155 (8x)

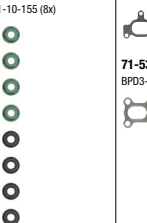

71-53514-00 
BP4W-13-111

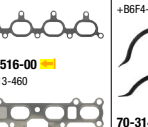

71-53516-00 
BPD3-13-460



10-52431-01
B6F4-10-427
+B6F4-10-428



70-31414-10

81-53253-00 
B3C7-10-602
36,5x50,5
A SL RD MVQ





81-53404-00 
BP05-11-312
83x100
A SL LD MVQ



81-53243-00  2x
F801-10-602
34x48
A SL RD MVQ



MAZDA

Ltr.   

1,8 BP6J 107 kW (146 PS) MX-5 11/00-10/05

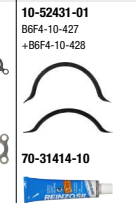
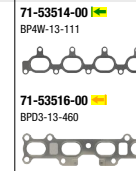
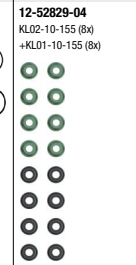
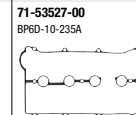
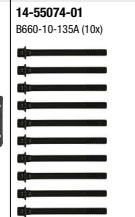
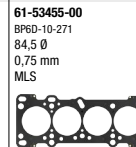
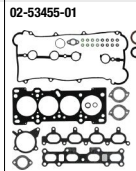
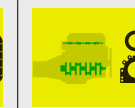
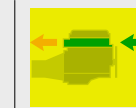

02-53455-01

61-53455-00
BP6D-10-271
84,5 Ø
0,75 mm
MLS

14-55074-01
B660-10-135A (10x)

71-53527-00
BP6D-10-235A

12-52829-04
KL02-10-155 (8x)
+KL01-10-155 (8x)

71-53514-00 
BP4W-13-111

71-53516-00 
BPD3-13-460

10-52431-01
B6F4-10-427
+B6F4-10-428

70-31414-10

81-53253-00 
B3C7-10-602
36,5x50,5
A SL RD MVQ

81-53404-00 
BP05-11-312
83x100
A SL LD MVQ

81-53243-00 
F801-10-602
34x48
A SL RD MVQ

81-53526-00 
ZL09-10-602
47x61
A SL RD MVQ

1,8 FP FP01LP 66-78 kW (90-106 PS) 626 08/91-06/97

01-52910-02
8AGX-10-271

02-52910-02
8AG6-10-235

61-52910-00
FP39-10-271
84,5 Ø
MLS

14-32184-01
FS01-10-135 (10x)

71-52861-00
FS01-10-235B

12-52829-04
KL02-10-155 (8x)
+KL01-10-155 (8x)

71-53511-00 
FSJ2-13-111A

71-52858-00 
FS01-13-460

70-31414-10

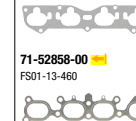
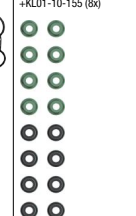
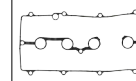
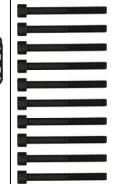
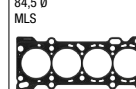
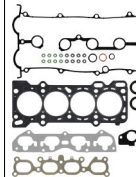
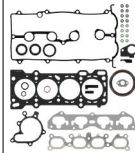















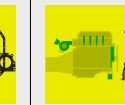
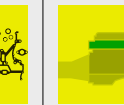
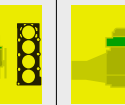

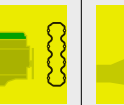
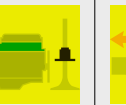
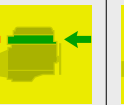

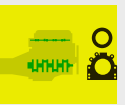
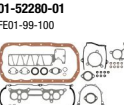

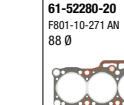
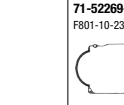
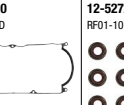
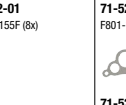
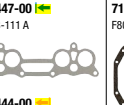
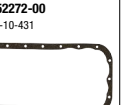

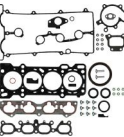
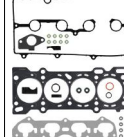
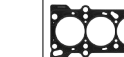
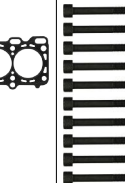
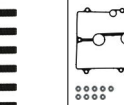
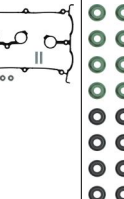











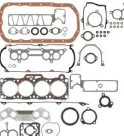
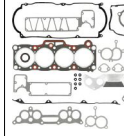
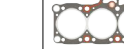

81-53277-00 
FS01-10-602
42,5x54,5
A SL RD MVQ

81-53339-00 
FS01-11-399
89x109
A SL LD MVQ

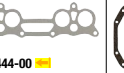
81-53243-00 
F801-10-602
34x48
A SL RD MVQ



MAZDA

<p>Ltr. </p>	<p>1,8 FP FPD9 FPE1 FPY3 FP55 FP87</p> <p>66-92 kW (90-125 PS)</p> <p>MX-6 PREMACY 323 626</p> <p>12/95-06/05</p>	<p></p>	<p></p>	<p></p>	<p></p>	<p></p>	<p></p>	<p></p>	<p></p>	<p></p>	<p></p>	<p></p>	<p></p>
<p>1,8 F8 (8V)</p> <p>62-67 kW (84-91 PS)</p> <p>B-SERIE E Kasten 626</p> <p>10/83-12/06</p>	<p></p>	<p></p>			<p></p>		<p></p>	<p></p>	<p></p>	<p></p>	<p></p>	<p></p>	
<p>01-52910-03 8F66-10-271</p> <p></p>	<p>02-52910-03</p> <p></p>	<p>61-52910-00 FP39-10-271 84,5 Ø MLS</p> <p></p>	<p>14-32184-01 FS01-10-135 (10x)</p> <p></p>	<p>15-53524-01 FSD7-10-235 +FS01-10-237A</p> <p></p>	<p>12-52829-04 KL02-10-155 (8x) +KL01-10-155 (8x)</p> <p></p>	<p>71-53511-00  FSJ2-13-111A</p> <p></p> <p>71-52858-00  FS01-13-460</p> <p></p>	<p>70-31414-10</p> <p></p>	<p>81-53277-00  FS01-10-602 42,5x54,5 A SL RD MVQ</p> <p></p> <p>81-53339-00  FS01-11-399 89x109 A SL LD MVQ</p> <p></p> <p>81-53243-00  F801-10-602 34x48 A SL RD MVQ</p> <p></p>					
<p>01-52280-01 FE01-99-100</p> <p></p>	<p>02-52280-02 FE01-99-101N</p> <p></p>	<p>61-52280-20 F801-10-271 AN 88 Ø</p> <p></p>			<p>71-52269-10 F801-10-235 D</p> <p></p>	<p>12-52722-01 RF01-10-F155F (8x)</p> <p></p>	<p>71-52447-00  F801-13-111 A</p> <p></p> <p>71-52444-00  F801-13-460 A</p> <p></p>	<p>71-52272-00 F801-10-431</p> <p></p>	<p>81-53243-00  F801-10-602 34x48 A SL RD MVQ</p> <p></p> <p>81-53342-00  90x110 A SL LD NBR</p> <p></p> <p>81-53243-00  F801-10-602 34x48 A SL RD MVQ</p> <p></p>				

MAZDA

Ltr.  1.8 F8 (12V) 58-69 kW (79-94 PS) E Kasten 626  02/84-05/92

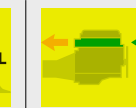

01-52705-01
8A65-10-271



02-52705-01



61-52705-00
FE1H-10-271 B
87,5 Ø

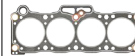

71-52681-00
F201-10-235 D

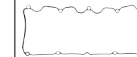

12-54023-02
B630-10-155 (12x)



70-54023-00
B630-10-155



12x

71-52678-00
F201-13-460 B



71-52272-00
F801-10-431

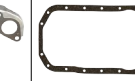

81-53243-00 **K**
F801-10-602
34x48
A SL RD MVQ



81-53341-10 **K**
F285-11-399
90x110
A SL LD FPM



81-53243-00 **N**
F801-10-602
34x48
A SL RD MVQ



1.8 K8D9 K8Y1 95-103 kW (129-140 PS) MX-3 MX-3 V6 626 05/91-10/97

61-53460-00 **R**
K801-10-271B
76 Ø
0,35 mm
MLS



61-53465-00 **L**
K801-10-272B
76 Ø
0,35 mm
MLS

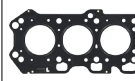

15-53528-01 **R**
KL01-10-235B
+FS01-10-237A (9x)
+KL01-10-243A (2x)

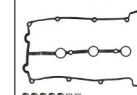

15-53529-01 **L**
KL01-10-205B
+FS01-10-237A (9x)
+KL01-10-243A (3x)

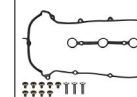

12-52829-05
KL01-10-155 (12x)
+KL02-10-155 (12x)

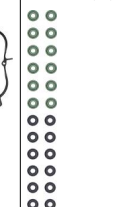

70-31414-10



81-53277-00 **K**
F801-10-602
42,5x54,5
A SL RD MVQ



81-53314-00 **K**
KL01-11-312
75x93
A SL LD MVQ



81-53228-00 **N**
B630-10-602
30x44
A SL RD NBR



2x

MAZDA													
Ltr.													
1,8 K8-ZE K819	98-103 kW (133-140 PS)	MX-3 MX-3 V6 XEDOS	01/92-10/97	01-53460-01 8DE1-10-271 	02-53460-01 8DE1-10-235 			61-53460-00 R K801-10-271B 76 Ø 0,35 mm MLS 		15-53528-01 R KL01-10-235B +FS01-10-237A (9x) +KL01-10-243A (2x) 15-53529-01 L KL01-10-2D5B +FS01-10-237A (9x) +KL01-10-243A (3x) 	12-52829-05 KL01-10-155 (12x) +KL02-10-155 (12x) 71-52856-00 L 2x KL02-13-111A 71-52854-00 2x KL68-13-460 	70-31414-10 	81-53277-00 K FS01-10-602 42,5x54,5 A SL RD MVQ 81-53314-00 K KL01-11-312 75x93 A SL LD MVQ 81-53228-00 N 2x B630-10-602 30x44 A SL RD NBR
1,8 L813 L829	75-88 kW (102-120 PS)	BONGO 6	08/02	01-35440-01 	02-35440-01 02-35440-02	08-39808-01 		61-35440-00 L801-10-271 85 Ø MLS 	14-32207-01 PEDD-10-135 (10x) 	15-35538-01 LF01-10-230 15-36563-01 LF14-10-230	12-35546-01 L807-10-155 (8x) +LF01-10-1F5 (8x) 71-35537-00 4x LF01-13-111 71-35488-00 L327-13-460A	70-31414-10 	81-35551-00 K LF01-10-602 37x50 A SL RD PTFE 81-90012-00 K LF01-11-310 PTFE
1,8 L823	85 kW (116 PS)	5	02/05-05/10	01-35440-01 	02-35440-02 	08-39808-01 		61-35440-00 L801-10-271 85 Ø MLS 	14-32207-01 PEDD-10-135 (10x) 	15-36563-01 LF14-10-230 	12-35546-01 L807-10-155 (8x) +LF01-10-1F5 (8x) 71-35537-00 4x LF01-13-111 71-35488-00 L327-13-460A	70-31414-10 	81-35551-00 K LF01-10-602 37x50 A SL RD PTFE 81-90012-00 K LF01-11-310 PTFE

MAZDA

Ltr. 93 kW (126 PS) MX-5 03/05-12/14



01-35440-03



02-35440-05



61-35440-00
L801-10-271
85 Ø
MLS

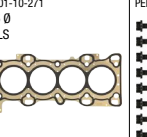

14-32207-01
PEDD-10-135 (10x)

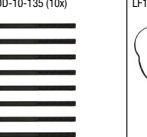

15-36563-01
LF14-10-230

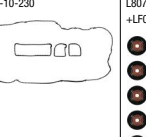

12-35546-01
L807-10-155 (8x)
+LF01-10-1F5 (8x)

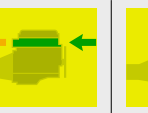
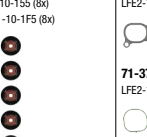

71-37447-00
LFE2-13-111

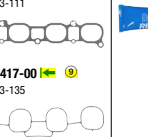

71-37417-00
LFE2-13-135



71-39471-00
LFD7-13-460A

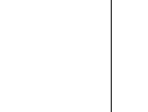

70-35544-00
LF01-10-1F5 8x

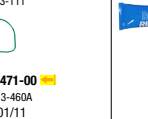

70-35546-00
L807-10-155 8x

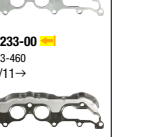

70-31414-10

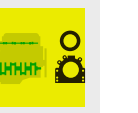

81-35551-00
LF01-10-602
37x50
A SL RD PTFE



81-90012-00
LF01-11-310
PTFE



1,8 L850 85 kW (116 PS) 5 09/10

01-35440-04
8LC1-10-271
 ⇒ 01/11

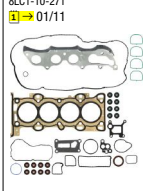

01-35440-05
8LC4-10-271
 02/11 →



61-35440-00
L801-10-271
85 Ø
MLS

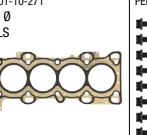

14-32207-01
PEDD-10-135 (10x)

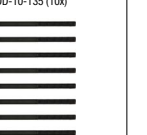

12-35546-01
L807-10-155 (8x)
+LF01-10-1F5 (8x)

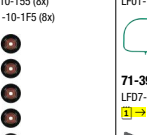

70-35544-00 AS
LF01-10-1F5 8x

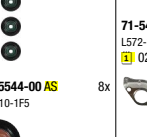

70-35546-00 ES
L807-10-155 8x

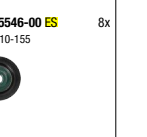

71-35537-00 4x
LF01-13-111



71-39471-00
LFD7-13-460A
 ⇒ 01/11

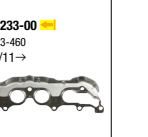

71-54233-00
L572-13-460
 02/11 →

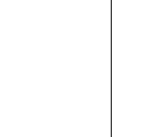

70-31414-10



81-53254-00
L366-10-602
37x50
A SL RD MVQ



81-90012-00
LF01-11-310
PTFE



MAZDA														
Ltr.														
1,8 S8Y1 S8Y2	85 kW (116 PS)	CX-3 CX-30 3 D	02/18	01-10836-01 8882-10-271				61-10836-00 S801-10-271 80,5 Ø MLS	14-12062-01 S550-10-135 (10x)	71-19138-00 S801-10-235	12-10162-02 SH01-10-155 (8x) +SH09-10-1F5 (8x)	71-12107-00 S550-13-111	4x 70-31414-10	81-10473-00 S550-10-602 45x56 A SL RD FPM
												71-12068-00 S550-13-460A		81-10474-00 S550-11-312B 88x105 A SL LD FPM
1,8 1E07(RTJ) 1E07(RTK) 1E12(RTJ) 1E12(RTK) 1E16(RTJ) 1E16(RTK)	44 kW (60 PS)			01-28352-05 03/94→ 08/98	02-28352-03 03/94→ 08/98	08-31615-01 03/94→ 08/98		61-31565-30 1E07-10-271A 83,8 Ø 1,5 mm	14-32017-01 1E07-10-135 (10x)	71-28352-00 1E07-10-235 03/94→ 08/98	12-27408-01 1E07-10-155 (8x)	71-27316-00 1E07-13-111	71-31615-00 1E07-10-431A	81-28359-10 66.67x89.3 A SL RD PTFE ACM
								61-31565-40 1E16-10-271A 83,8 Ø 1,6 mm	2 			71-34112-00 1E07-10-235A 09/98→	71-12107-00 S550-13-111	81-23001-20 LE04-11-312 79,38x95,25 A SL LD FPM 03/94→ 08/98
				01-34112-01 09/98→	02-34112-01 09/98→		61-31565-50 1E24-10-271A 83,8 Ø 1,65 mm	3 	4 		70-27408-00 1E07-10-155	8x 71-12107-00 S550-13-111	8x 71-12107-00 S550-13-460A	81-90007-00 PTFE 09/98→
														81-26268-00 28x38 A SL RD FPM

MAZDA

Ltr.  1.8 1E10(RTN) 55 kW (75 PS) 121  02/00-10/02 

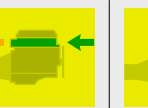
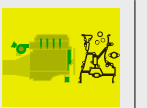

1,8 1E10(RTN) 55 kW (75 PS) 121 02/00-10/02

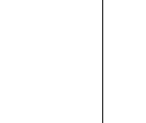
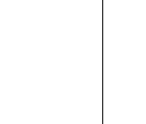
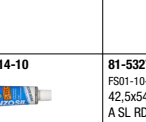
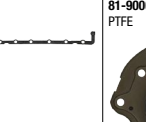
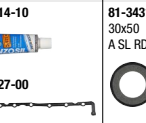
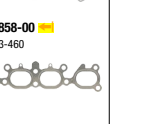
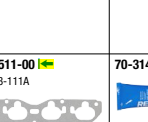
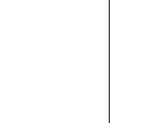
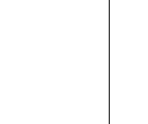
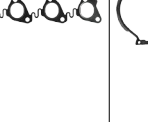
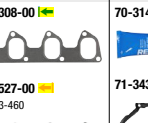
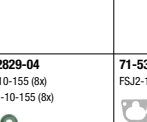
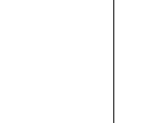
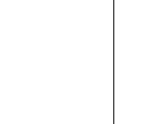
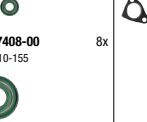
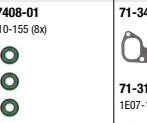
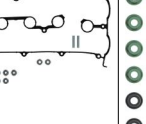
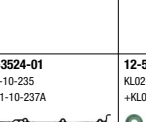
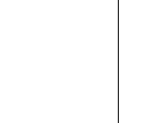
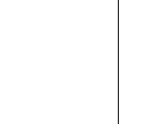
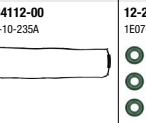
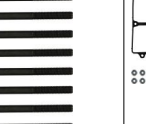
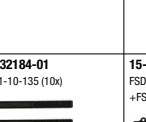
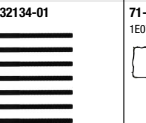
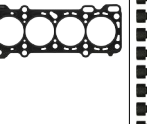
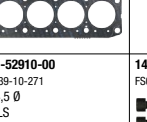
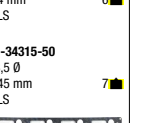
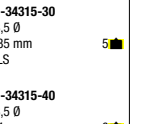
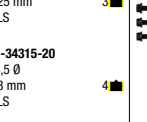
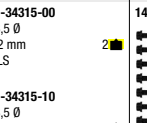
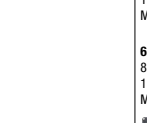
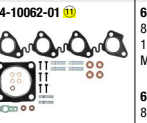
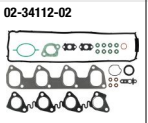



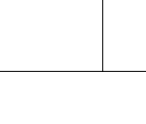
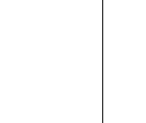
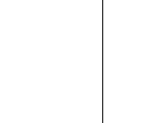
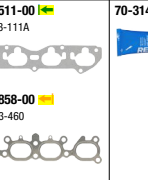
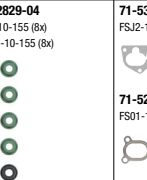
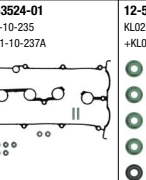
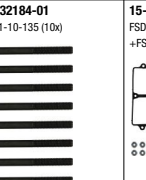
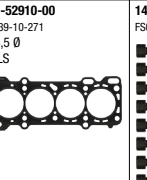
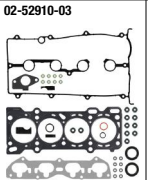
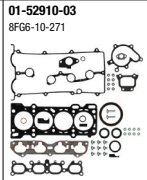





















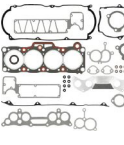





1,9 FP FPY3 FP55 66-84 kW (90-114 PS) 323 05/97-10/02



MAZDA				
1,9 RZ4E-TC	110 kW (150 PS)	BT-50	01/21	
2,0 FE (12V) FEY9	66-81 kW (90-110 PS)	E Kasten E 2000 ,2200 E-SERIE 626	08/87-08/99	
2,0 FE (16V) FECM	103-110 kW (140-150 PS)	626	06/87-09/97	

<p>01-11133-01</p>	<p>02-11133-01</p>				<p>61-10814-00 81,2 Ø 0,95 mm MLS</p> <p>61-10814-10 81,2 Ø 1 mm MLS</p> <p>61-10814-20 81,2 Ø 1,05 mm MLS</p>	<p>14-18344-01</p>	<p>15-18346-01</p> <p>71-18346-00</p>	<p>12-18517-01</p> <p>16x</p> <p>70-31414-10</p>	<p>71-18348-00 </p> <p>71-18350-00 </p>	<p>81-10616-00 </p> <p>57x76 AB SL RD FPM</p> <p>81-10617-00 </p> <p>83x108 AB SL LD FPM</p>	
<p>01-52705-04 8AS9-10-271</p>	<p>02-52705-04</p>				<p>61-52705-00 FE1H-10-271 B 87,5 Ø</p>		<p>71-52681-00 F201-10-235 D</p>	<p>12-54023-02 B630-10-155 (12x)</p> <p>12x</p> <p>70-54023-00 B630-10-155</p>	<p>71-53531-00 </p> <p>F285-13-111A</p> <p>71-53532-00 </p> <p>FE1H-13-460A</p>	<p>70-31414-10</p> <p>71-52272-00 F801-10-431</p>	<p>81-53243-00 </p> <p>F801-10-602 34x48 A SL RD MVQ</p> <p>81-53462-00 </p> <p>G601-11-399 90x110 A SL LD MVQ</p> <p>81-53243-00 </p> <p>F801-10-602 34x48 A SL RD MVQ</p>
<p>01-52435-01 8AG6-10-271</p>	<p>02-52435-01 8AG6-10-271 HS</p>				<p>61-52435-00 FE3N-10-271 87,5 Ø</p>		<p>71-52434-00 FE3N-10-235 A</p>	<p>12-52829-01 B660-10-155 (16x)</p>	<p>71-53054-00 </p> <p>FE3N-13-111</p> <p>71-53056-00 </p> <p>FE3N-13-460</p>	<p>71-52272-00 F801-10-431</p>	<p>81-53243-00 </p> <p>F801-10-602 34x48 A SL RD MVQ</p> <p>81-53342-00 </p> <p>90x110 A SL LD NBR</p> <p>81-53243-00 </p> <p>F801-10-602 34x48 A SL RD MVQ</p>





















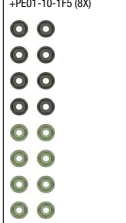

MAZDA

Ltr.															
2,0	FE (8V) FECK FEFA FEV4 FEY7 FE18 FE-3L FE-3M FE58 FE60 FE61	60-88 kW (82-120 PS)	E 2000 ,2200 E-SERIE 500 626 929	11/82-05/03	01-52280-01 FE01-99-100 	02-52280-02 FE01-99-101N 									81-53243-00 K F801-10-602 34x48 A SL RD MVQ  81-53342-00 K 90x110 A SL LD NBR  81-53243-00 N F801-10-602 34x48 A SL RD MVQ 
2,0	FEBN	60 kW (82 PS)	E2000	10/88-05/95				61-52705-00 FE1H-10-271 B 87,5 Ø 		71-52269-10 F801-10-235 D 	12-52722-01 RF01-10-F155F (8x) 				
2,0	FET	87-89 kW (118-121 PS)	626 Turbo 929	10/84-10/87				61-52280-20 F801-10-271 AN 88 Ø 		71-52269-10 F801-10-235 D 	12-52722-01 RF01-10-F155F (8x) 	71-52447-00 I F801-13-111 A  71-52444-00 I F801-13-460 A 	71-52272-00 F801-10-431 	81-53243-00 K F801-10-602 34x48 A SL RD MVQ  81-53342-00 K 90x110 A SL LD NBR  81-53243-00 N F801-10-602 34x48 A SL RD MVQ 	







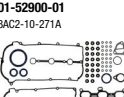
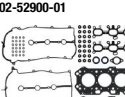

MAZDA														
Ltr.														
2,0 FS	85-86 kW (115-117 PS)	MX-6 626	08/91-04/97 1	01-52910-02 8AGX-10-271 	02-52910-02 8AG6-10-235 			61-52910-00 FP39-10-271 84,5 Ø MLS 	14-32184-01 FS01-10-135 (10x) 	71-52861-00 FS01-10-235B 	12-52829-04 KL02-10-155 (8x) +KL01-10-155 (8x) 	71-53511-00 FSJ2-13-111A 71-52858-00 FS01-13-460 	70-31414-10 	81-53277-00 FS01-10-602 42,5x54,5 A SL RD MVQ 81-53339-00 FS01-11-399 89x109 A SL LD MVQ 81-53243-00 F801-10-602 34x48 A SL RD MVQ
2,0 FS FS-DS FS2C FS7E FS7G	85-100 kW (115-136 PS)	MPV PREMACY 323 626	05/97-06/05	01-53490-02 8CG7-10-271 	02-53490-02 			61-53490-00 FSH9-10-271 84,5 Ø 0,95 mm MLS 	14-32184-01 FS01-10-135 (10x) 	15-53524-01 FSD7-10-235 +FS01-10-237A 	12-52829-04 KL02-10-155 (8x) +KL01-10-155 (8x) 	71-53511-00 FSJ2-13-111A 71-52858-00 FS01-13-460 	70-31414-10 	81-53277-00 FS01-10-602 42,5x54,5 A SL RD MVQ 81-53339-00 FS01-11-399 89x109 A SL LD MVQ 81-53243-00 F801-10-602 34x48 A SL RD MVQ
2,0 HEE HE3 M MA	66 kW (90 PS)	626 929	10/78	01-52277-01 HE26-99-100 B 	02-52277-02 HE26-99-101 BN 			61-52277-10 0453-10-271 D 81 Ø 		15-52026-01 	12-52722-01 RF01-10-F155F (8x) 		71-52023-00 0221-10-431 	

MAZDA

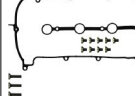
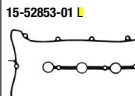
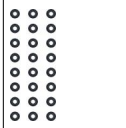

Ltr.  2,0 HFY1 HFY7 132-137 kW (179-186 PS) CX-30 3 06/19 **[NEW]**















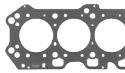

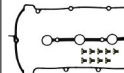
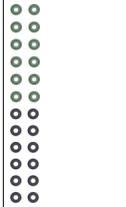



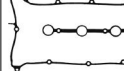



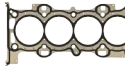

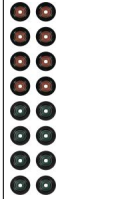
										
				<p>61-10830-00 HF01-10-271B 86 Ø MLS</p> 	<p>14-20621-01 HF01-10135A (10X)</p> 	<p>71-20616-00 A HF01-10-235A</p>  <p>71-20617-00 I HF01-10-205A</p> 	<p>12-10138-01 PE01-10-155 (8X) +PE01-10-1F5 (8X)</p>  <p>70-10138-00 PE01-10-155 8x</p>  <p>70-10139-00 PE01-10-1F5 8x</p> 	<p>71-20620-00 I HF01-13-111</p>  <p>71-20615-00 HF01-13-460</p> 	<p>71-20623-00 HF01-10-431</p> 	<p>81-10661-00 K HF01-10-602 48,5x60,5 A SL RD FPM</p>  <p>81-10660-00 K HF01-11-312 88x105 A SL LD FPM</p> 

2,0 KF KF1 103-126 kW (140-171 PS) XEDOS XEDOS V6 323 626 01/92-08/00



				<p>61-52900-00 R KF01-10-271A 79,5 Ø MLS</p>  <p>61-52905-00 L KF01-10-272A 79,5 Ø MLS</p> 	<p>15-52852-01 R</p>  <p>15-52853-01 L</p> 	<p>12-52829-03 B660-10-155 (24x)</p> 	<p>71-52856-00 I 2x KL02-13-111A</p>  <p>71-52854-00 2x KL68-13-460</p> 	<p>70-31414-10</p> 	<p>81-53277-00 K FS01-10-602 42,5x54,5 A SL RD MVQ</p>  <p>81-53314-00 K KL01-11-312 75x93 A SL LD MVQ</p>  <p>81-53228-00 N 2x B630-10-602 30x44 A SL RD NBR</p> 
-----------------------------------------------------------------------------------	-----------------------------------------------------------------------------------	--	--	------------------------------------------------------------------------------------------------------------------------------------------------------------------------------------------------------------------------------------------------------------------------------------------------------------	------------------------------------------------------------------------------------------------------------------------------------------------------------------------------------------------------------------------------------	-------------------------------------------------------------------------------------------------------------------------------------	-------------------------------------------------------------------------------------------------------------------------------------------------------------------------------------------------------------------------------------------------------------------------	---------------------------------------------------------------------------------------------------------------	----------------------------------------------------------------------------------------------------------------------------------------------------------------------------------------------------------------------------------------------------------------------------------------------------------------------------------------------------------------------------------------------------------------------------------------------------------------------------------------------

MAZDA

Ltr.  2,0 KFZE 118 kW (160 PS) 626  08/91-12/95

				<p>61-53070-00 R KL01-10-271B 85,5 Ø MLS</p> 		<p>15-52852-01 R</p> 	<p>12-52829-05 KL01-10-155 (12x) +KL02-10-155 (12x)</p> 		<p>70-31414-10</p> 	<p>81-53277-00 K↔ FS01-10-602 42,5x54,5 A SL RD MVQ</p> 
				<p>61-53075-00 L KL01-10-272B 85,5 Ø MLS</p> 		<p>15-52853-01 L</p> 				<p>81-53314-00 K↔ KL01-11-312 75x93 A SL LD MVQ</p>  <p>81-53228-00 N 2x B630-10-602 30x44 A SL RD NBR</p> 
<p>2,0 LF-DE 106-112 kW (144-152 PS) BIANTE 10/03 LFN7 3 LFN8 6 LF-VD LF-VDS LFYA LFYB LF4J LF4K</p>	<p>01-37685-02 8LBN-10-271</p> 			<p>61-37685-00 L3G2-10-271A MLS</p> 	<p>14-32207-01 PEDD-10-135 (10x)</p> 	<p>15-36563-01 LF14-10-230</p> 	<p>12-35546-01 L807-10-155 (8x) +LF01-10-1F5 (8x)</p>  <p>70-35544-00 LF01-10-1F5 8x</p>  <p>70-35546-00 L807-10-155 8x</p> 	<p>71-35537-00  4x LF01-13-111</p>  <p>71-39471-00  LFD7-13-460A</p> 	<p>70-31414-10</p> 	<p>81-53254-00 K↔ L3G6-10-602 37x50 A SL RD MVQ</p>  <p>81-90012-00 K↔ LF01-11-310 PTFE</p> 

MAZDA

Ltr.   

2,0 LF-DE 114 kW (155 PS) 6 01/10-07/13



01-54120-02
8LBV-10-271







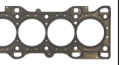

61-54120-00
LF3F-10-271
89 0
MLS



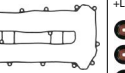

14-32207-01
PEDD-10-135 (10x)

15-54231-01
L3K9-10-230



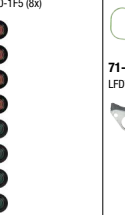

12-35546-01
L807-10-155 (8x)
+LF01-10-1F5 (8x)





70-35544-00
LF01-10-1F5 8x

70-35546-00
L807-10-155 8x



71-54234-00  4x
L807-13-111



71-39471-00 
LFD7-13-460A



70-31414-10





81-53254-00 
L3G6-10-602
37x50
A SL RD MVO





81-90012-00 
LF01-11-310
PTFE





2,0 LFF7 107 kW (146 PS) 5 02/05-05/10

01-35435-01
8LG1-10-271
 08/07





01-37685-01
 09/07→





02-35435-01  08/07





02-35435-02  08/07





02-37685-01
 09/07→



61-35435-00
L309-10-271
89 0
MLS
 08/07

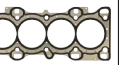

61-37685-00
L3G2-10-271A
MLS
 09/07→

14-32207-01
PEDD-10-135 (10x)

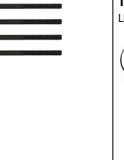

15-35538-01 
LF01-10-230



15-36563-01 
LF14-10-230





12-35546-01
L807-10-155 (8x)
+LF01-10-1F5 (8x)





70-35544-00
LF01-10-1F5 8x

70-35546-00
L807-10-155 8x







71-35537-00  4x
LF01-13-111



71-35488-00 
L327-13-460A
 08/07



71-39471-00 
LFD7-13-460A
 09/07→

70-31414-10



81-35551-00 
LF01-10-602
37x50
A SL RD PTFE























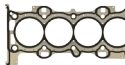







81-90012-00 
LF01-11-310
PTFE





















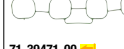

MAZDA



Ltr.  2,0 LFF7 108 kW (147 PS) 6 03/05-08/07 

										
<p>01-37685-01</p> 	<p>02-37685-01</p> 			<p>61-37685-00 L3G2-10-271A MLS</p> 	<p>14-32207-01 PEDD-10-135 (10x)</p> 	<p>15-36563-01  LF14-10-230</p> 	<p>12-35546-01 L807-10-155 (8x) +LF01-10-1F5 (8x)</p>  <p>70-35544-00 LF01-10-1F5 8x</p>  <p>70-35546-00 L807-10-155 8x</p> 	<p>71-35537-00  4x LF01-13-111</p>  <p>71-39471-00  LFD7-13-460A</p> 	<p>70-31414-10</p> 	<p>81-35551-00  LF01-10-602 37x50 A SL RD PTFE</p>  <p>81-90012-00  LF01-11-310 PTFE</p> 

2,0 LFG7 102-127 kW (139-173 PS) MX-5 3 10/03 5

<p>01-37685-01</p> 	<p>02-37685-01</p> 			<p>61-37685-00 L3G2-10-271A MLS</p> 	<p>14-32207-01 PEDD-10-135 (10x)</p> 	<p>15-36563-01 LF14-10-230</p> 	<p>12-35546-01 L807-10-155 (8x) +LF01-10-1F5 (8x)</p>  <p>70-35544-00 LF01-10-1F5 8x</p>  <p>70-35546-00 L807-10-155 8x</p> 	<p>71-37447-00  4x LFE2-13-111</p>  <p>71-37417-00   LFE2-13-135</p>  <p>71-39471-00  LFD7-13-460A</p> 	<p>70-31414-10</p> 	<p>81-35551-00  LF01-10-602 37x50 A SL RD PTFE</p>  <p>81-90012-00  LF01-11-310 PTFE</p> 
-------------------------------------------------------------------------------------------------------------	-------------------------------------------------------------------------------------------------------------	--	--	----------------------------------------------------------------------------------------------------------------------------------------	-------------------------------------------------------------------------------------------------------------------------------------	-------------------------------------------------------------------------------------------------------------------------------	-------------------------------------------------------------------------------------------------------------------------------------------------------------------------------------------------------------------------------------------------------------------------------------------------------------------------------------------------------------------------------------------------------------------------------	-----------------------------------------------------------------------------------------------------------------------------------------------------------------------------------------------------------------------------------------------------------------------------------------------------------------------------------------------------------------------------------------------------------------------------------------------------------------------------------------------------------------------------------------------------------------------------------------------------------------------------------------------------------------------------------------------------------------------------------------------	---------------------------------------------------------------------------------------------------------------	-------------------------------------------------------------------------------------------------------------------------------------------------------------------------------------------------------------------------------------------------------------------------------------------------------------------------------------------------------------------------------------------------------------------------------------------------------------------------

MAZDA

Ltr.  2,0 LF-ZB 106-110 kW (144-150 PS) 5  1 06/10



01-54120-02
8LBV-10-271
1 ⇒ 01/11



01-54120-01
8LC3-10-271
1 ⇒ 02/11 →



61-54120-00
LF3F-10-271
89 0
MLS



14-32207-01
PEDD-10-135 (10x)



15-54231-01
L3K9-10-230

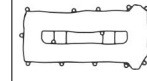

12-35546-01
L807-10-155 (8x)
+LF01-10-1F5 (8x)

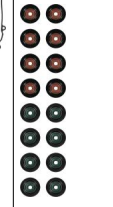

70-35544-00
LF01-10-1F5





70-35546-00
L807-10-155

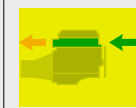

8x

8x



71-54234-00  4x
L807-13-111



71-39471-00 
LFD7-13-460A
1 ⇒ 01/11



71-54233-00 
L572-13-460
1 ⇒ 02/11 →



70-31414-10

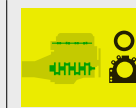

81-53254-00 
L3G6-10-602
37x50
A SL RD MVO



81-90012-00 
LF01-11-310
PTFE



MAZDA

Ltr.  2,0 LFZ2 111 kW (151 PS) 3 DISI  12/08-05/13 

 **01-37685-02**
8LBN-10-271
 ⇒ 01/11

 **01-54120-02 (A)**
8LBV-10-271
 ⇒ 01/11

 **01-37685-03**
8LBZ-10-271
 ⇒ 02/11→

 **01-54120-01 (A)**
8LC3-10-271
 ⇒ 02/11→



61-37685-00
L3G2-10-271A
MLS



61-54120-00 (A)
LF3F-10-271
89 0
MLS





14-32207-01
PEDD-10-135 (10x)





15-36563-01
LF14-10-230



15-54231-01 (A)
L3K9-10-230

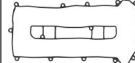





12-35546-01
L807-10-155 (8x)
+LF01-10-1F5 (8x)



70-35544-00
LF01-10-1F5





70-35546-00
L807-10-155









71-35537-00  4x
LF01-13-111





71-54234-00  (A) 4x
L807-13-111



71-39471-00 
LFD7-13-460A
 ⇒ 01/11



71-54233-00 
L572-13-460
 ⇒ 02/11→





70-31414-10



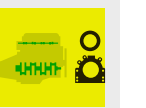

81-53254-00 
L3G6-10-602
37x50
A SL RD MVO





81-90012-00 
LF01-11-310
PTFE



MAZDA															
Ltr.	2,0 LF17 LF18	104 kW (141 PS)	6	06/02-08/07	<p>01-35435-01 8L61-10-271 MLS 1 ⇒ 02/05</p> <p>01-37685-01 1 ⇒ 03/05 →</p>	<p>02-35435-01 </p> <p>1 ⇒ 02/05</p> <p>02-35435-02 </p> <p>1 ⇒ 02/05</p> <p>02-37685-01 1 ⇒ 03/05 →</p>			<p>61-35435-00 L309-10-271 89 Ø MLS 1 ⇒ 02/05</p> <p>61-37685-00 L362-10-271A MLS 1 ⇒ 03/05 →</p>	<p>14-32207-01 PEDD-10-135 (10x)</p>	<p>15-35538-01 </p> <p>LF01-10-230</p> <p>15-36563-01 </p> <p>LF14-10-230</p>	<p>12-35546-01 L807-10-155 (8x) +LF01-10-1F5 (8x)</p> <p>70-35544-00 LF01-10-1F5</p> 8x	<p>71-35537-00 </p> <p>LF01-13-111</p> 4x	<p>70-31414-10</p> <p>71-35488-00 </p> <p>L327-13-460A 1 ⇒ 02/05</p> <p>71-39471-00 </p> <p>LF07-13-460A 1 ⇒ 03/05 →</p> 8x	<p>81-35551-00 </p> <p>LF01-10-602 37x50 A SL RD PTFE</p> <p>81-90012-00 </p> <p>LF01-11-310 PTFE</p>
Ltr.	2,0 LF17	108 kW (147 PS)	6	08/07-07/13	<p>01-37685-01</p>	<p>02-37685-01</p>			<p>61-37685-00 L362-10-271A MLS</p>	<p>14-32207-01 PEDD-10-135 (10x)</p>	<p>15-35538-01 </p> <p>LF01-10-230</p> <p>15-36563-01 </p> <p>LF14-10-230</p>	<p>12-35546-01 L807-10-155 (8x) +LF01-10-1F5 (8x)</p> <p>70-35544-00 LF01-10-1F5</p> 8x	<p>71-35537-00 </p> <p>LF01-13-111</p> 4x	<p>70-31414-10</p> <p>71-39471-00 </p> <p>LF07-13-460A</p> 8x	<p>81-35551-00 </p> <p>LF01-10-602 37x50 A SL RD PTFE</p> <p>81-90012-00 </p> <p>LF01-11-310 PTFE</p>

MAZDA

Ltr.  2,0 LF5H LF5W 108-110 KW (147-150 PS) 3 01/09-09/14 

01-54120-01
 8LC3-10-271







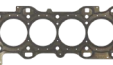



61-54120-00
 LF3F-10-271
 89 0
 MLS

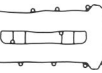

14-32207-01
 PEDD-10-135 (10x)



15-54231-01
 L3K9-10-230



12-35546-01
 L807-10-155 (8x)
 +LF01-10-1F5 (8x)

70-35544-00
 LF01-10-1F5 8x
70-35546-00
 L807-10-155 8x



71-54234-00  4x
 L807-13-111

71-54233-00 
 L572-13-460







70-31414-10







81-53254-00 
 L3G6-10-602
 37x50
 A SL RD MVO

81-90012-00 
 LF01-11-310
 PTFE







2,0 LF50 LF72 104-110 KW (141-150 PS) 3 10/03-12/09



01-35435-01
 8LG1-10-271
 02/06

01-37685-01
 03/06 →

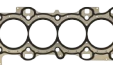

02-35435-02
 02/06

02-37685-01
 03/06 →













61-35435-00
 L309-10-271
 89 0
 MLS
 02/06

61-37685-00
 L3G2-10-271A
 MLS
 03/06 →





14-32207-01
 PEDD-10-135 (10x)



15-36563-01 
 LF14-10-230



12-35546-01
 L807-10-155 (8x)
 +LF01-10-1F5 (8x)

70-35544-00
 LF01-10-1F5 8x
70-35546-00
 L807-10-155 8x



71-35537-00  4x
 LF01-13-111

71-35488-00 
 L327-13-460A
 02/06

71-39471-00 
 LFD7-13-460A
 03/06 →





70-31414-10



















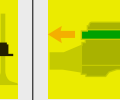



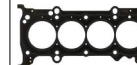

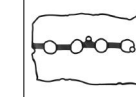
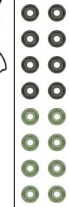
81-35551-00 
 LF01-10-602
 37x50
 A SL RD PTFE

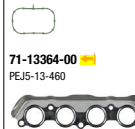
81-90012-00 
 LF01-11-310
 PTFE











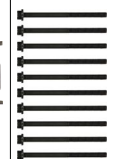
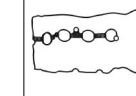
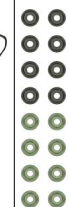

MAZDA														
Ltr.														
2,0	PE-VPR PEXL PEX0 PEX2 PEX3 PEY4 PEY5 PEY6 PEY7	88-125 kW (120-170 PS)	CX-3 CX-5 3 6	09/11	01-10017-01 8LAA-10-271B 				61-10017-00 PE01-10-271 87,5 Ø MLS 	14-32207-01 PEDD-10-135 (10x) 	71-10137-00 PE01-10-235 	12-10138-01 PE01-10-155 (8X) +PE01-10-1F5 (8X) 70-10138-00 PE01-10-155 8x 70-10139-00 PE01-10-1F5 8x 	71-10140-00 4x PE01-13-111 71-10141-00 PE17-13-460 	70-31414-10 81-10380-00 PE01-10-602 43x56 A SL RD FPM 81-10381-00 PE01-11-312 82x98 A SL LD FPM
2,0	PEXB PEXP	88-121 kW (120-165 PS)	CX-3 CX-30 CX-5 3 6	01/13	01-10017-02 8PE2-10-271 			61-10017-00 PE01-10-271 87,5 Ø MLS 	14-32207-01 PEDD-10-135 (10x) 	71-10137-00 PE01-10-235 	12-10138-01 PE01-10-155 (8X) +PE01-10-1F5 (8X) 70-10138-00 PE01-10-155 8x 70-10139-00 PE01-10-1F5 8x 	71-10140-00 4x PE01-13-111 71-10141-00 PE17-13-460 	70-31414-10 81-10380-00 PE01-10-602 43x56 A SL RD FPM 81-10381-00 PE01-11-312 82x98 A SL LD FPM 	

MAZDA

Ltr.  2,0 PEXF 135 kW (184 PS) MX-5 05/18 

										
<p>01-10307-02 8PE3-10-271</p> 				<p>61-10307-00 PEES-10-271 85 Ø MLS</p> 	<p>14-32207-01 PEDD-10-135 (10x)</p> 	<p>71-13369-00 PEES-10-235</p> 	<p>12-10138-01 PE01-10-155 (8X) +PE01-10-1F5 (8X)</p>  <p>70-10138-00 ES 8x PE01-10-155</p> <p>70-10139-00 AS 8x PE01-10-1F5</p>	<p>71-19323-00  4x PE31-13-111</p>  <p>71-13364-00  PEJ5-13-460</p>	<p>70-31414-10</p> 	<p>81-10380-00  PE01-10-602 43x56 A SL RD FPM</p>  <p>81-10381-00  PE01-11-312 82x98 A SL LD FPM</p> 

2,0 PEXN 90-115 kW (122-156 PS) CX-30 11/18 3

				<p>61-10017-00 PE01-10-271 87,5 Ø MLS</p> 	<p>14-32207-01 PEDD-10-135 (10x)</p> 	<p>71-19012-00 PE29-10-235</p> 	<p>12-10138-01 PE01-10-155 (8X) +PE01-10-1F5 (8X)</p>  <p>70-10138-00 8x PE01-10-155</p> <p>70-10139-00 8x PE01-10-1F5</p>	<p>71-10140-00  4x PE01-13-111</p>  <p>71-10141-00  PE17-13-460</p>	<p>70-31414-10</p> 	<p>81-10380-00  PE01-10-602 43x56 A SL RD FPM</p>  <p>81-10381-00  PE01-11-312 82x98 A SL LD FPM</p> 
-----------------------------------------------------------------------------------	--	--	--	--------------------------------------------------------------------------------------------------------------------------------------------------	-------------------------------------------------------------------------------------------------------------------------------------	-------------------------------------------------------------------------------------------------------------------------------	----------------------------------------------------------------------------------------------------------------------------------------------------------------------------------------------------------------------------------------------------	----------------------------------------------------------------------------------------------------------------------------------------------------------------------------------------------------------------------------------------------------------------------------------------------------------------------------------------------------	---------------------------------------------------------------------------------------------------------------	-----------------------------------------------------------------------------------------------------------------------------------------------------------------------------------------------------------------------------------------------------------------------------------------------------------------------------------------------------------------------------------------------------------------------------------------------------------------------------------------

MAZDA

Ltr.  2,0 PEX2 121 kW (165 PS) 3 07/13-05/19  1



01-10017-01
8LAA-10-271B
 11/14

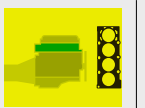

61-10017-00
PE01-10-271
87,5 Ø
MLS

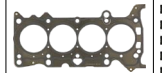

14-32207-01
PEDD-10-135 (10x)

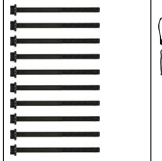

71-10137-00
PE01-10-235

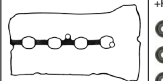

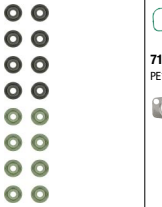

12-10138-01
PE01-10-155 (8X)
+PE01-10-1F5 (8X)

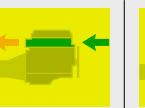

70-10138-00
PE01-10-155 8x

70-10139-00
PE01-10-1F5 8x



71-10140-00  4x
PE01-13-111
 11/14

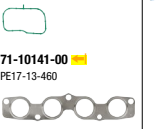

71-10141-00 
PE17-13-460

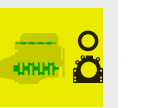

70-31414-10

81-10380-00 
PE01-10-602
43x56
A SL RD FPM



81-10381-00 
PE01-11-312
82x98
A SL LD FPM



2,0 PEX4 114-118 kW (155-160 PS) MX-5 06/15

01-10307-01
8LN8-10-271



61-10307-00
PEES-10-271
85 Ø
MLS

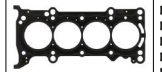

14-32207-01
PEDD-10-135 (10x)

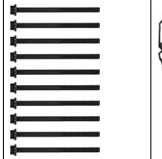

71-13369-00
PEES-10-235

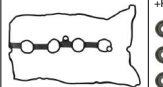

12-10138-01
PE01-10-155 (8X)
+PE01-10-1F5 (8X)

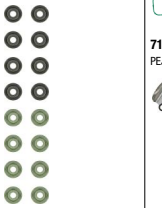

70-10138-00  ES 8x
PE01-10-155

70-10139-00  AS 8x
PE01-10-1F5



71-10140-00  4x
PE01-13-111

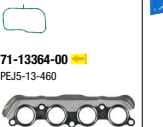

71-13364-00 
PEJ5-13-460

70-31414-10

81-10380-00 
PE01-10-602
43x56
A SL RD FPM























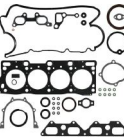
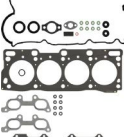















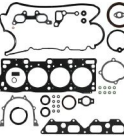
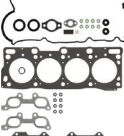

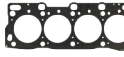





81-10381-00 
PE01-11-312
82x98
A SL LD FPM





























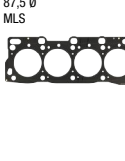

MAZDA															
2,0	PEY2	113 kW (154 PS)	3	09/11-09/14	01-10017-01 8LAA-10-271B 1 ⇒ 01/14 				61-10017-00 PE01-10-271 87,5 Ø MLS 	14-32207-01 PEDD-10-135 (10x) 	71-10137-00 PE01-10-235 1 ⇒ 01/14 	12-10138-01 PE01-10-155 (8x) +PE01-10-1F5 (8x) 8x 70-10138-00 PED1-10-155 8x 70-10139-00 PED1-10-1F5 8x 	71-10140-00 PE01-13-111 1 ⇒ 01/14 71-10141-00 PE17-13-460 	70-31414-10 	81-10380-00 PE01-10-602 43x56 A SL RD FPM 81-10381-00 PE01-11-312 82x98 A SL LD FPM
2,0	RF RF65 RFH5 RFH7 RF-N RF55 RF83	44-60 kW (60-82 PS)	626 626 D	07/87	01-53115-01 8AU3-10-271 B 	02-53115-01 8AU3-10-235 			61-53115-00 RFJ5-10-271 C 87,6 Ø MLS 		71-52291-00 RF01-10-235 	12-52722-01 RF01-10-F155F (8x) 8x 71-52439-00 RF01-13-462 	71-52438-00 RF01-13-111 71-52439-00 RF01-13-462 	71-52272-00 F801-10-431 	81-53243-00 F801-10-602 34x48 A SL RD MVQ 81-53342-00 90x110 A SL LD NBR 81-53243-00 F801-10-602 34x48 A SL RD MVQ
2,0	RF1G	52 kW (71 PS)	323 D	10/96-05/04					61-53115-00 RFJ5-10-271 C 87,6 Ø MLS 		71-52291-00 RF01-10-235 				

MAZDA

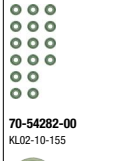
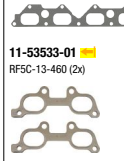

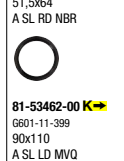







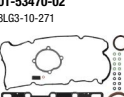
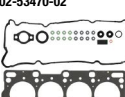

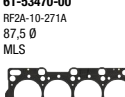
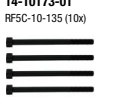
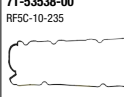





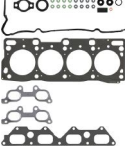

<p>Ltr. </p>	<p>2,0 RF3F RF4F</p>	<p>63-81 kW (86-110 PS)</p>	<p>BONGO PREMACY TD 626 DI 626 DTD 626 T 626 TD</p>	<p>04/98-08/10 </p>											
<p>2,0 RF4F</p>	<p>66-74 kW (90-101 PS)</p>	<p>PREMACY DTD PREMACY TD 323 DTD 323 TD</p>	<p>09/98-06/05</p>	<p>01-53470-03 8LB2-10-271</p> 	<p>02-53470-03</p> 		<p>04-10182-01 </p> 	<p>61-53470-00 RF2A-10-271A 87,5 Ø MLS</p> 		<p>71-53536-00 RF2A-10-235</p> 	<p>12-52829-06 KL02-10-155 (16x)</p> 	<p>71-53534-00 </p> <p>RF2A-13-111A</p>  <p>11-53533-01 </p> <p>RF5C-13-460 (2x)</p>  <p>70-54282-00</p> <p>KL02-10-155</p>  <p>16x</p>	<p>70-31414-10</p> 	<p>81-53537-00 </p> <p>RF2A-10-602 51,5x64 A SL RD NBR</p>  <p>81-53462-00 </p> <p>G801-11-399 90x110 A SL LD MVQ</p>  <p>81-53228-00 N</p> <p>B630-10-602 30x44 A SL RD NBR</p> 	
	<p>2,0 RF4F</p>	<p>66-74 kW (90-101 PS)</p>	<p>PREMACY DTD PREMACY TD 323 DTD 323 TD</p>	<p>09/98-06/05</p>	<p>01-53470-03 8LB2-10-271</p> 	<p>02-53470-03</p> 		<p>04-10106-01 </p> 	<p>61-53470-00 RF2A-10-271A 87,5 Ø MLS</p> 		<p>71-53536-00 RF2A-10-235</p> 	<p>12-52829-06 KL02-10-155 (16x)</p> 	<p>71-53534-00 </p> <p>RF2A-13-111A</p>  <p>11-53533-01 </p> <p>RF5C-13-460 (2x)</p>  <p>70-54282-00</p> <p>KL02-10-155</p>  <p>16x</p>	<p>70-31414-10</p> 	<p>81-53537-00 </p> <p>RF2A-10-602 51,5x64 A SL RD NBR</p>  <p>81-53462-00 </p> <p>G801-11-399 90x110 A SL LD MVQ</p>  <p>81-53228-00 N</p> <p>B630-10-602 30x44 A SL RD NBR</p> 

MAZDA

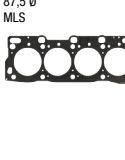

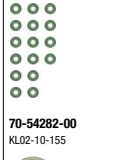
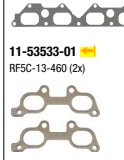

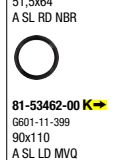



















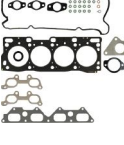

















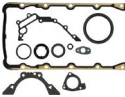



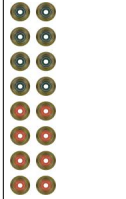











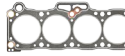

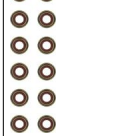

Ltr.  2,0 RF5C 89 kW (121 PS) 6 DI 08/02-08/07  1

										
01-53470-02 8LG3-10-271	02-53470-02		04-10071-01   02/05	61-53470-00 RF2A-10-271A 87,5 Ø MLS	14-10173-01 RF5C-10-135 (10x)	71-53538-00 RF5C-10-235	12-52829-06 KL02-10-155 (16x)	71-53534-00  RF2A-13-111A	70-31414-10 	81-53537-00  RF2A-10-602 51,5x64 A SL RD NBR
			 04-10231-01   03/05→				 70-54282-00 KL02-10-155	 11-53533-01  RF5C-13-460 (2x)		 81-53462-00  G801-11-399 90x110 A SL LD MVQ
										 81-53228-00 N B630-10-602 30x44 A SL RD NBR





















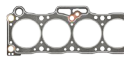



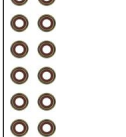



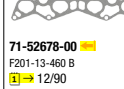











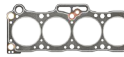

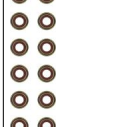
2,0 RF5C 100 kW (136 PS) MPV Di 6 DI 06/02-08/07

										
01-53470-02 8LG3-10-271	02-53470-02		04-10071-01  	61-53470-00 RF2A-10-271A 87,5 Ø MLS	14-10173-01 RF5C-10-135 (10x)	71-53538-00 RF5C-10-235	12-52829-06 KL02-10-155 (16x)	71-53534-00  RF2A-13-111A	70-31414-10 	81-53537-00  RF2A-10-602 51,5x64 A SL RD NBR
							 70-54282-00 KL02-10-155	 11-53533-01  RF5C-13-460 (2x)		 81-53462-00  G801-11-399 90x110 A SL LD MVQ
										 81-53228-00 N B630-10-602 30x44 A SL RD NBR

MAZDA

























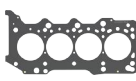
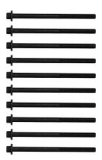
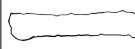
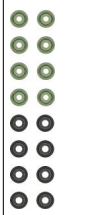









<p>Ltr. </p>	<p>2,0 RF7J RF8G</p>	<p>81-105 kW (110-143 PS)</p>	<p>3 5 CD 6 6 DI</p>	<p>02/05-12/10 </p>											
<p>2,0 RF7J RF8G</p>	<p>81-105 kW (110-143 PS)</p>	<p>3 5 CD 6 6 DI</p>	<p>02/05-12/10</p>	<p>01-53470-04 8LBF-10-271</p> 	<p>02-53470-04</p> 		<p>04-10231-01 </p> 	<p>61-53470-00 RF2A-10-271A 87,5 Ø MLS</p> 	<p>14-10173-01 RF5C-10-135 (10x)</p> 	<p>71-53538-00 RF5C-10-235</p> 	<p>12-52829-06 KL02-10-155 (16x)</p> 	<p>71-53534-00 </p> <p>RF2A-13-111A</p> 	<p>71-53533-01 </p> <p>RF5C-13-460 (2x)</p> 	<p>70-31414-10</p> 	<p>81-53537-00 </p> <p>RF2A-10-602 51,5x64 A SL RD NBR</p>  <p>81-53462-00 </p> <p>G801-11-399 90x110 A SL LD MVQ</p>  <p>81-53228-00 </p> <p>B630-10-602 30x44 A SL RD NBR</p> 
<p>2,0 YF</p>	<p>91-97 kW (124-132 PS)</p>	<p>TRIBUTE</p>	<p>03/00-05/08</p>			<p>08-34341-01</p> 	<p>61-34340-00 86,5 Ø 1,3 mm MLS</p> 	<p>61-34440-00 YF09-10-271B 86 Ø 0,6 mm MLS</p> 	<p>14-32018-01 YF09-10-135</p> 	<p>71-34333-00 YF-09-10-235B</p> 	<p>12-33032-01 YF09-13-111 (8x)</p> 	<p>71-34322-00 </p> <p>YF09-13-111</p> 	<p>71-34309-00 </p> <p>YF09-13-461</p> 	<p>71-34341-00 YF09-10-431</p> 	<p>81-34316-00 </p> <p>YF10-10-602A 35x50 A SL RD PTFE ACM</p>  <p>81-34344-00 </p> <p>YF09-11-399 89x108 A SL LD ACM</p> 
<p>2,2 F2 F2L1</p>	<p>85 kW (116 PS)</p>	<p>626</p>	<p>05/91-11/92</p>	<p>01-52705-03 8AU8-10-271</p> 	<p>02-52705-03</p> 			<p>61-52705-00 FE1H-10-271 B 87,5 Ø</p> 		<p>71-52681-00 F201-10-235 D</p> 	<p>12-54023-02 B630-10-155 (12x)</p> 	<p>71-52688-00 </p> <p>F201-13-111</p> 	<p>71-52444-00 </p> <p>F801-13-460 A</p> 	<p>71-52272-00 F801-10-431</p> 	<p>81-53243-00 </p> <p>F801-10-602 34x48 A SL RD MVQ</p>  <p>81-53341-10 </p> <p>F285-11-399 90x110 A SL LD FPM</p>  <p>81-53243-00 </p> <p>F801-10-602 34x48 A SL RD MVQ</p> 

MAZDA

<p>Ltr. </p>	<p>2,2 F2</p>	<p>85-94 kW (115-128 PS)</p>	<p>626 626 12V 929 12V</p>	<p>11/87-11/96</p>		<p>01-52705-02 8AG8-10-271 B 12/90</p>		<p>01-52705-03 8AU8-10-271 01/91→</p>			<p>02-52705-02 8AG3-10-235 A 12/90</p>		<p>02-52705-03 01/91→</p>													<p>61-52705-00 FE1H-10-271 B 87,5 Ø</p>										<p>71-52681-00 F201-10-235 D</p>					<p>12-54023-02 B630-10-155 (12x)</p>		<p>70-54023-00 B630-10-155</p>			<p>71-52688-00  F201-13-111</p>		<p>71-52678-00  F201-13-460 B 12/90</p>			<p>71-52272-00 F801-10-431</p>					<p>81-53243-00  F801-10-602 34x48 A SL RD MVQ</p>		<p>81-53341-10  F285-11-399 90x110 A SL LD FPM</p>	
<p>2,2 F2 F2E F2-EGI F21</p>	<p>85-100 kW (115-136 PS)</p>	<p>626 12V 929 929 12V</p>	<p>05/87-07/90</p>	<p>01-52705-02 8AG8-10-271 B</p>		<p>02-52705-02 8AG3-10-235 A</p>				<p>61-52705-00 FE1H-10-271 B 87,5 Ø</p>				<p>71-52681-00 F201-10-235 D</p>		<p>12-54023-02 B630-10-155 (12x)</p>		<p>71-52688-00  F201-13-111</p>		<p>71-52678-00  F201-13-460 B</p>		<p>71-52272-00 F801-10-431</p>		<p>81-53243-00  F801-10-602 34x48 A SL RD MVQ</p>		<p>81-53341-10  F285-11-399 90x110 A SL LD FPM</p>																																	

MAZDA															
2.2	F2G	85 kW (115 PS)			<p>01-52705-02 8AG8-10-271 B 1 01/88 → 2 12/90</p> <p>01-52705-03 8AU8-10-271 1 01/91 →</p>	<p>02-52705-02 8AG3-10-235 A 1 01/88 → 2 12/90</p> <p>02-52705-03 1 01/91 →</p>			<p>61-52705-00 FE1H-10-271 B 87,5 Ø</p>		<p>71-52681-00 F201-10-235 D</p>	<p>12-54023-02 B630-10-155 (12x)</p> <p>70-54023-00 B630-10-155</p>	<p>71-52688-00 </p> <p>F201-13-111</p> <p>71-52678-00 </p> <p>F201-13-460 B 1 12/90</p> <p>71-52444-00 </p> <p>F801-13-460 A 1 01/91 →</p>	<p>71-52272-00 F801-10-431</p>	<p>81-53243-00 </p> <p>F801-10-602 34x48 A SL RD MVQ</p> <p>81-53341-10 </p> <p>F285-11-399 90x110 A SL LD FPM</p> <p>81-53243-00 </p> <p>F801-10-602 34x48 A SL RD MVQ</p>
2.2	F2T	100-108 kW (136-147 PS)	MX-6 626 T	10/87-12/92					<p>61-52705-00 FE1H-10-271 B 87,5 Ø</p>		<p>71-52681-00 F201-10-235 D</p>			<p>81-53243-00 </p> <p>F801-10-602 34x48 A SL RD MVQ</p> <p>81-53243-00 </p> <p>F801-10-602 34x48 A SL RD MVQ</p>	
2.2	P4-AT	88-115 kW (120-156 PS)	BT-50	11/11	<p>02-42374-02</p>	<p>08-35536-03</p>		<p>61-43175-00 U207-10-271 1,1 mm MLS</p> <p>61-43175-10 U209-10-271 1,15 mm MLS</p> <p>61-43175-20 U211-10-271 1,2 mm MLS</p>	<p>14-32341-01 U202-10-136 (8x)</p>	<p>71-42374-00 U205-10-205</p>	<p>12-35549-01 U202-10-155 (16x)</p> <p>70-35549-00 U202-10-155</p>	<p>71-35539-00 </p> <p>U210-13-111</p> <p>71-33894-00 </p> <p>U202-13-460</p>	<p>15-35536-01 U222-10-431A</p> <p>70-31414-10</p>	<p>81-90014-00 </p> <p>U202-10-602 PTFE</p> <p>81-90013-00 </p> <p>U202-11-312 PTFE</p>	

MAZDA

<p>Ltr.  R5A2</p> <p>60 kW (82 PS)</p> <p>B-SERIE</p> <p> 02/99-11/06</p>											
<p>2.2 SH-VPTR SH-VPTS SHY4 SHY6</p> <p>110-140 kW (150-190 PS)</p> <p>CX-5 CX-8 3 3D 6 6D</p> <p>04/12</p>	<p>01-10026-01 8LK1-10-271B</p> 			<p>61-10026-00 SH01-10-271E 85 0 MLS</p> 	<p>14-10174-01 SH01-10-135 (10X)</p> 	<p>71-10161-00 SH01-10-235</p> 	<p>12-10162-02 SH01-10-155 (8X) +SH09-10-1F5 (8X)</p>  <p>8x</p> <p>70-10162-00 SH01-10-155</p>  <p>70-12117-00 SH09-10-1F5</p> 	<p>71-10164-00 </p> <p>SH01-13-111</p>  <p>71-10414-00 </p> <p>PE17-13-460</p> 	<p>71-52447-00 </p> <p>F801-13-111 A</p>  <p>71-52272-00 F801-10-431</p> 	<p>81-53243-00 </p> <p>F801-10-602 34x48 A SL RD MVQ</p>  <p>81-53342-00 </p> <p>90x110 A SL LD NBR</p>  <p>81-53243-00 </p> <p>F801-10-602 34x48 A SL RD MVQ</p> 	<p>81-10385-00 </p> <p>SH01-10-602 51,5x64 A SL RD FPM</p>  <p>81-10386-00 </p> <p>SH01-11-312 90x110 A SL LD FPM</p> 

MAZDA														
Ltr.														
2.2 SHY1	110-129 kW (150-175 PS)	CX-5 6	04/12	01-10026-01 8LK1-10-271B 				61-10026-00 SH01-10-271E 85 0 MLS 	14-10174-01 SH01-10-135 (10X) 	71-10161-00 SH01-10-235 	12-10162-01 SH01-10-155 (8X) +SH01-10-1F5 (8X) 8x 70-10162-00 SH01-10-155 8x 70-10163-00 SH01-10-1F5 	71-10164-00 SH01-13-111 71-10414-00 PE17-13-460 	70-31414-10 	81-10385-00 SH01-10-602 51,5x64 A SL RD FPM 81-10386-00 SH01-11-312 90x110 A SL LD FPM
2.2 SHY8	110 kW (150 PS)	6	12/12	01-10026-02 8SH1-10-271A 03/18→ 				61-10026-00 SH01-10-271E 85 0 MLS 	14-10174-01 SH01-10-135 (10X) 	71-10161-00 SH01-10-235 	12-10162-02 SH01-10-155 (8X) +SH09-10-1F5 (8X) 8x 70-10162-00 SH01-10-155 8x 70-12117-00 SH09-10-1F5 	71-10164-00 SH01-13-111 71-19034-00 SH18-13-460A 03/18→ 	70-31414-10 	81-10385-00 SH01-10-602 51,5x64 A SL RD FPM 81-10386-00 SH01-11-312 90x110 A SL LD FPM

MAZDA

Ltr.  2.2 SHY8 135-140 kW (184-190 PS) CX-5 6 03/18



01-10026-02
8SH1-10-271A

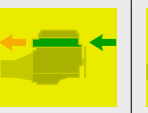

61-10026-00
SH01-10-271E
85 Ø
MLS



14-10174-01
SH01-10-135 (10X)



71-10161-00
SH01-10-235



12-10162-02
SH01-10-155 (8X)
+SH09-10-1F5 (8X)

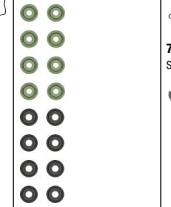

70-10162-00
SH01-10-155



70-12117-00
SH09-10-1F5



8x

71-10164-00 
SH01-13-111



71-19034-00 
SH18-13-460A



70-31414-10



81-10385-00 
SH01-10-602
51,5x64
A SL RD FPM





81-10386-00 
SH01-11-312
90x110
A SL LD FPM

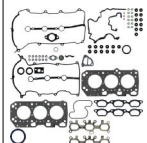

2.3 KJ-ZEM 155 kW (211 PS) XEDOS V6 02/95-01/00

01-54150-01
8DK3-10-271



61-54150-00 
KJ01-10-271
81,5 Ø
MLS

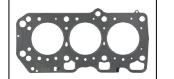

61-54155-00 
KJ01-10-272
81,5 Ø
MLS



15-54228-01 
KJ01-10-235
+FS01-10-237A (11x)

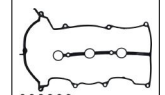

15-54229-01 
KJ01-10-2D5
+FS01-10-237A (11x)

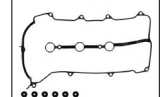

12-52829-05
KL01-10-155 (12x)
+KL02-10-155 (12x)

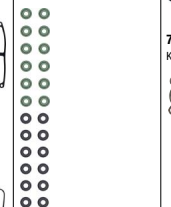

71-54227-00  2x
KJ01-13-111



71-52854-00  2x
KL68-13-460



70-31414-10



81-53277-00 
FS01-10-602
42,5x54,5
A SL RD MVQ



81-53314-00 
KL01-11-312
75x93
A SL LD MVQ



81-53228-00  2x
B630-10-602
30x44
A SL RD NBR



MAZDA															
Ltr.															
2,3	L3 L3-VE L3X L333	104-131 kW (141-178 PS)	MPV PREMACY TRIBUTE 5 6	06/02	01-35435-01 8L61-10-271 	02-35435-01 02-35435-02 			61-35435-00 L309-10-271 89 0 MLS 	14-32207-01 PEDD-10-135 (10x) 	15-35538-01 LF01-10-230 	12-35546-01 L807-10-155 (8x) +LF01-10-1F5 (8x) 70-35544-00 LF01-10-1F5 8x 70-35546-00 L807-10-155 8x 	71-35537-00 LF01-13-111 4x 71-35488-00 L327-13-460A 	70-31414-10 	81-35551-00 LF01-10-602 37x50 A SL RD PTFE 81-90012-00 LF01-11-310 PTFE
2,3	L3C1 L3-V	114-120 kW (155-163 PS)	3 5 6	03/05-12/10	01-37685-01 	02-37685-01 			61-37685-00 L3G2-10-271A MLS 	14-32207-01 PEDD-10-135 (10x) 	15-36563-01 LF14-10-230 	12-35546-01 L807-10-155 (8x) +LF01-10-1F5 (8x) 70-35544-00 LF01-10-1F5 8x 70-35546-00 L807-10-155 8x 	71-35537-00 LF01-13-111 4x 71-39471-00 LFD7-13-460A 	70-31414-10 	81-35551-00 LF01-10-602 37x50 A SL RD PTFE 81-90012-00 LF01-11-310 PTFE

MAZDA

Ltr. 119-122 kW (162-166 PS) 6 01/02-02/08

01-35435-01
8LG1-10-271
1 ⇒ 02/05

01-37685-01
1 ⇒ 03/05 →

02-35435-01
1 ⇒ 02/05

02-35435-02
1 ⇒ 02/05

02-37685-01
1 ⇒ 03/05 →



61-35435-00
L309-10-271
89 Ø
MLS
1 ⇒ 02/05

61-37685-00
L362-10-271A
MLS
1 ⇒ 03/05 →

14-32207-01
PEDD-10-135 (10x)

15-35538-01
LF01-10-230

15-36563-01
LF14-10-230

12-35546-01
L807-10-155 (8x)
+LF01-10-1F5 (8x)

70-35544-00
LF01-10-1F5

70-35546-00
L807-10-155

71-35537-00 4x
LF01-13-111

71-35488-00
L327-13-460A
1 ⇒ 02/05

71-39471-00
LFD7-13-460A
1 ⇒ 03/05 →

70-31414-10

81-35551-00

LF01-10-602
37x50
A SL RD PTFE

81-90012-00

LF01-11-310
PTFE

2,3 L3KG 175-196 kW (238-267 PS) CX-7 01/04
L3K7 3
L3M6 6
L3N9
L3-VDT
L3YH
L3Y7

01-54160-01
8LAB-10-271

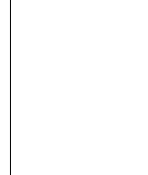

61-54160-00
L3K9-10-271C
89 Ø
MLS



15-54231-01
L3K9-10-230

12-54247-01
L3K9-10-155A (8x)
+L3K9-10-1F5A (8x)

71-54244-00
L3K9-13-111

71-54243-00
L3K9-13-460

70-31414-10



81-53254-00

L3G6-10-602
37x50
A SL RD MVQ

81-90012-00

LF01-11-310
PTFE

MAZDA

Ltr. 		
2,3 L3-V	117-119 kW (159-162 PS)	09/03-12/06
3	5	1

01-35435-01
8L61-10-271
12/05





01-37685-01
01/06→



02-35435-02
12/05



02-37685-01
01/06→

61-35435-00
L309-10-271
89 0
MLS
12/05





61-37685-00
L362-10-271A
MLS
01/06→



14-32207-01
PEDD-10-135 (10x)



15-36563-01 
LF14-10-230



12-35546-01
L807-10-155 (8x)
+LF01-10-1F5 (8x)

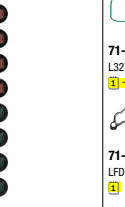



70-35544-00
LF01-10-1F5



70-35546-00
L807-10-155



71-35537-00  4x
LF01-13-111



71-35488-00
L327-13-460A
12/05



71-39471-00
LFD7-13-460A
01/06→



70-31414-10



81-35551-00 
LF01-10-602
37x50
A SL RD PTFE



81-90012-00 
LF01-11-310
PTFE



2,5 GY-DE	125 kW (170 PS)	09/99-03/02
MPV MPV V6		

02-35130-01



08-34338-01
AJ03-10-SHO

61-35125-00 
GY01-10-272A
83 0
MLS





61-35130-00 
GY01-10-271
83 0
MLS





14-32171-01
GY01-10-135A (16x)



71-35191-00 
GY01-10-235



71-35192-00 
GY01-10-2D5



12-34343-01
GY01-10-155 (24x)





70-34343-00
GY01-10-155



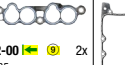

71-34311-00  2x
GY01-13-111

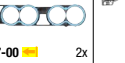

71-34312-00   2x
GY01-13-135



71-34307-00  2x
GY01-13-460A



71-34338-00
AJ04-10-431A

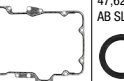



81-34314-00 
AJ03-10-602A
47,62x63,5
AB SL RD ACM



81-34318-00 
AJ03-11-312A
91x106
AB LD NBR



MAZDA

Ltr.  2,5 GY1 129 kW (175 PS) MPV  08/99-06/02  1

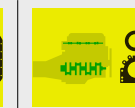
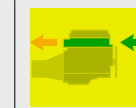

2,5 GY1 129 kW (175 PS) MPV 08/99-06/02

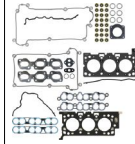
02-35130-01

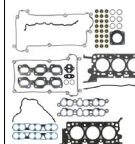
 ⇒ 09/00

02-35140-01

 ⇒ 10/00→

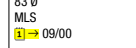
08-34338-01

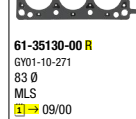
 AJ03-10-SHO

61-35125-00 L

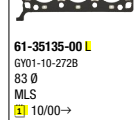
 GY01-10-272A
 83 Ø
 MLS
 ⇒ 09/00

61-35130-00 R

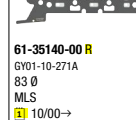
 GY01-10-271
 83 Ø
 MLS
 ⇒ 09/00

61-35135-00 L

 GY01-10-272B
 83 Ø
 MLS
 ⇒ 10/00→

61-35140-00 R

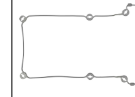
 GY01-10-271A
 83 Ø
 MLS
 ⇒ 10/00→

14-32171-01

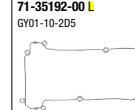

 GY01-10-135A (16x)

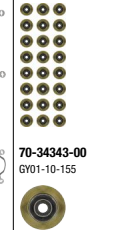

71-35191-00 R

 GY01-10-235



71-35192-00 L

 GY01-10-2D5

12-34343-01

 GY01-10-155 (24x)



70-34343-00

 GY01-10-155



71-34311-00 L  2x

 GY01-13-111

71-34312-00 L  2x

 GY01-13-135

71-34307-00  2x

 GY01-13-460A

71-34338-00

 AJ04-10-431A

81-34314-00 K 

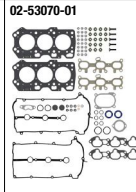
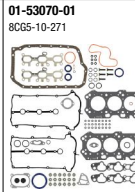
 AJ03-10-602A
 47,62x63,5
 AB SL RD ACM

81-34318-00 K 

 AJ03-11-312A
 91x108
 AB LD NBR

2,5 KL KL-ZE 120-147 kW (163-200 PS) MX-6 MX-6 V6 XEDOS V6 XEDOS 9 626 626 V6 01/92-10/02



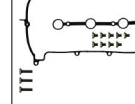

61-53070-00 R

 KL01-10-271B
 85,5 Ø
 MLS

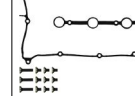

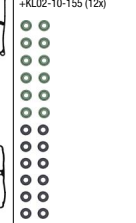
61-53075-00 L

 KL01-10-272B
 85,5 Ø
 MLS

15-52852-01 R

 KL01-10-155 (12x)
 +KL02-10-155 (12x)



15-52853-01 L

 KL01-10-155 (12x)
 +KL02-10-155 (12x)



12-52829-05

 KL01-10-155 (12x)
 +KL02-10-155 (12x)

71-52856-00 L  2x

 KL02-13-111A

71-52854-00  2x

 KL68-13-460

70-31414-10

81-53277-00 K 

 FS01-10-602
 42,5x54,5
 A SL RD MVQ

81-53314-00 K 

 KL01-11-312
 75x93
 A SL LD MVQ























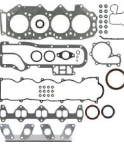
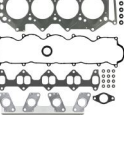



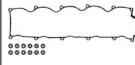















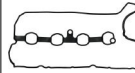

81-53228-00 N 2x

 B630-10-602
 30x44
 A SL RD NBR

MAZDA															
Ltr.															
2,5 L5-VE	117-125 kW (159-170 PS)	CX-7 5 6	08/07	01-54165-01 8LGE-10-271 					61-54165-00 L504-10-271 90,5 Ø MLS 	14-32207-01 PEDD-10-135 (10x) 	15-36563-01 LF14-10-230 	12-35546-01 L807-10-155 (8x) +LF01-10-1F5 (8x) 	71-54251-00 L505-13-111 71-39471-00 LFD7-13-460A 	70-31414-10 	81-53254-00 L366-10-602 37x50 A SL RD MVQ 81-90012-00 LF01-11-310 PTFE
2,5 L5-VE	122 kW (166 PS)	3	03/09-09/14	01-54165-01 8LGE-10-271 09/10 01-54165-02 8LC2-10-271 10/10→ 				61-54165-00 L504-10-271 90,5 Ø MLS 	14-32207-01 PEDD-10-135 (10x) 	15-36563-01 LF14-10-230 	12-35546-01 L807-10-155 (8x) +LF01-10-1F5 (8x) 	71-54251-00 L505-13-111 71-39471-00 LFD7-13-460A 09/10 71-54233-00 L572-13-460 10/10→ 	70-31414-10 	81-53254-00 L366-10-602 37x50 A SL RD MVQ 81-90012-00 LF01-11-310 PTFE 	
2,5 L5-VE	125 kW (170 PS)	3	01/12-12/13	01-54165-02 8LC2-10-271 				61-54165-00 L504-10-271 90,5 Ø MLS 	14-32207-01 PEDD-10-135 (10x) 	15-36563-01 LF14-10-230 	12-35546-01 L807-10-155 (8x) +LF01-10-1F5 (8x) 	71-54251-00 L505-13-111 71-54233-00 L572-13-460 	70-31414-10 	81-53254-00 L366-10-602 37x50 A SL RD MVQ 81-90012-00 LF01-11-310 PTFE 	

MAZDA															
2,5	L5-X	125 kW (170 PS)	3	01/10-12/13	<p>01-54165-01 8LGE-10-271 10/09/10</p> <p>01-54165-02 8LC2-10-271 10/10/10</p>				<p>61-54165-00 L504-10-271 90,5 Ø MLS</p>	<p>14-32207-01 PEDD-10-135 (10x)</p>	<p>15-36563-01 LF14-10-230</p>	<p>12-35546-01 L807-10-155 (8x) +LF01-10-1F5 (8x)</p> <p>70-35544-00 LF01-10-1F5</p> <p>70-35546-00 L807-10-155</p>	<p>71-54251-00 4x L505-13-111</p> <p>71-39471-00 LFD7-13-460A 10/09/10</p> <p>71-54233-00 L572-13-460 10/10/10</p>	<p>70-31414-10</p>	<p>81-53254-00 L366-10-602 37x50 A SL RD MVQ</p> <p>81-90012-00 LF01-11-310 PTFE</p>
2,5	MD25NA WL WLE7 WLE9 WLF5 WL-T WL31	57-92 kW (77-125 PS)	B-SERIE B-SERIE D	02/92	<p>01-53065-01 8ASX-10-271</p>	<p>02-53065-01</p>			<p>61-53065-00 WL01-10-271B 94,5 Ø MLS</p>	<p>14-32211-02 WL51-10-135B (10x) +WL51-10-136B (8x)</p>	<p>15-52993-01 WL01-10-235</p>	<p>12-52992-01 WL01-10-155 (12x)</p> <p>70-52992-00 WL01-10-155</p>	<p>71-52994-00 WL51-13-111</p> <p>71-52996-00 WL51-13-460A</p>	<p>70-31414-10</p>	<p>81-53461-00 VS01-10-602 53x70 A SL RD</p> <p>81-53462-00 G601-11-399 90x110 A SL LD MVQ</p> <p>81-53459-00 N RF03-12-603A 32x46 A SL LD MVQ</p>

MAZDA

<p>Ltr. </p>											
<p>2,5 MD25TI WL84</p> <p>80 kW (109 PS)</p> <p>B-SERIE TD</p> <p>05/96-11/06</p> <p>1</p>	<p>01-53065-01 8ASX-10-271</p> 	<p>02-53065-01</p> 		<p>04-10176-01 </p> 	<p>61-53065-00 WL01-10-271B 94,5 Ø MLS</p> 	<p>14-32211-02 WLS1-10-135B (10x) +WLS1-10-136B (8x)</p> 	<p>15-52993-01 WL01-10-235</p> 	<p>12-52992-01 WL01-10-155 (12x)</p>  <p>70-52992-00 WL01-10-155</p>  <p>12x</p>	<p>71-52994-00 </p> <p>WLS1-13-111</p>  <p>71-52996-00 </p> <p>WLS1-13-460A</p> 	<p>70-31414-10</p> 	<p>81-53461-00 </p> <p>VS01-10-602 53x70 A SL RD</p>  <p>81-53462-00 </p> <p>G801-11-399 90x110 A SL LD MVQ</p>  <p>81-53459-00 </p> <p>RF03-12-603A 32x46 A SL LD MVQ</p> 
<p>2,5 PY-VPS PYY1 PYY3 PY-Y8 PY-ZA</p> <p>135-143 kW (184-194 PS)</p> <p>CX-5 CX-8</p> <p>3 6</p> <p>12/12</p>	<p>01-10175-01 8LGN-10-271B</p> 				<p>61-10175-00 PY01-10-271 90,5 Ø MLS</p> 	<p>14-32207-01 PEDD-10-135 (10x)</p> 	<p>71-12118-00 PY01-10-235</p> 	<p>12-10138-01 PED1-10-155 (8x) +PED1-10-1F5 (8x)</p>  <p>70-10138-00 PED1-10-155</p>  <p>8x</p> <p>70-10139-00 PED1-10-1F5</p>  <p>8x</p>	<p>71-12114-00 </p> <p>PY01-13-111</p>  <p>71-12066-00 </p> <p>PY01-13-460</p> 	<p>70-31414-10</p> 	<p>81-10380-00 </p> <p>PE01-10-602 43x56 A SL RD FPM</p>  <p>81-10474-00 </p> <p>S550-11-312B 88x105 A SL LD FPM</p> 















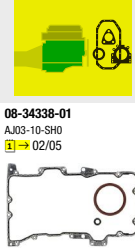
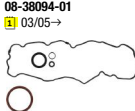

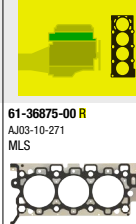

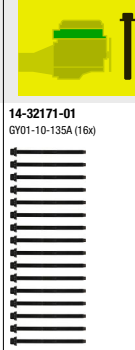
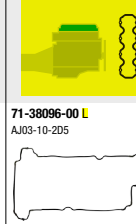
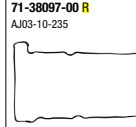
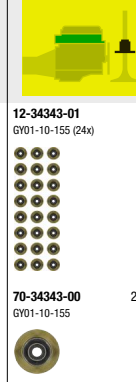

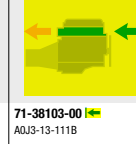

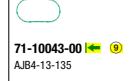

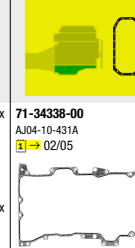
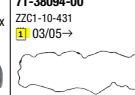



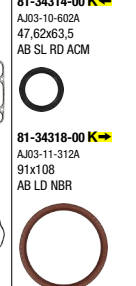

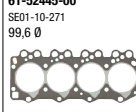
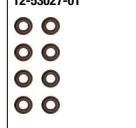





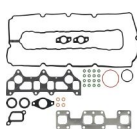

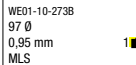
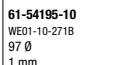
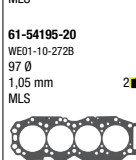
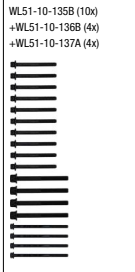
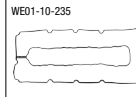
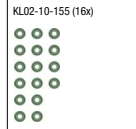
MAZDA

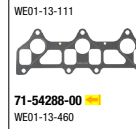
Ltr.	Icon	Power (kW/PS)	Model	Year	Part 1	Part 2	Part 3	Part 4	Part 5	Part 6	Part 7	Part 8	Part 9	Part 10	Part 11
2,5		139-143 kW (189-194 PS)	CX-30 CX-5 3 6	05/17	01-10175-03 8PY3-10-271A 				61-10175-00 PY01-10-271 90,5 Ø MLS 	14-32207-01 PEDD-10-135 (10x) 	71-19267-00 PYFA-10-235 	12-10138-01 PE01-10-155 (8X) +PE01-10-1F5 (8X) 8x 70-10138-00 PED1-10-155 8x 70-10139-00 PED1-10-1F5 	71-12114-00 PY01-13-111 71-12066-00 PY01-13-460 	70-31414-10 	81-10380-00 PE01-10-602 43x56 A SL RD FPM 81-10474-00 SS50-11-312B 88x105 A SL LD FPM
2,5	PYZ4	170-186 kW (231-253 PS)	CX-5 CX-9T D 6 6T	06/16	01-10868-01 8PY1-10-271B 				61-10868-00 PY8W-10-271A 90,5 Ø MLS 	14-12062-01 SS50-10-135 (10x) 	71-19266-00 PY8W-10-235 	12-10162-02 SH01-10-155 (8X) +SH09-10-1F5 (8X) 8x 70-10162-00 SH01-10-155 8x 70-12117-00 SH09-10-1F5 	71-12114-00 PY01-13-111 71-19281-00 PY8V-13-460A 	70-31414-10 	81-10380-00 PE01-10-602 43x56 A SL RD FPM 81-10386-00 SH01-11-312 90x110 A SL LD FPM

MAZDA															
Ltr.															
2,5 PYZ8	139-143 kW (189-194 PS)	CX-5 3 6	05/17	01-10175-02 8PY2-10-271A 					61-10175-00 PY01-10-271 90,5 Ø MLS 	14-32207-01 PEDD-10-135 (10x) 	71-12118-00 PY01-10-235 	12-10138-01 PE01-10-155 (8x) +PE01-10-1F5 (8x) 70-10138-00 PE01-10-155 8x 70-10139-00 PE01-10-1F5 8x	71-12114-00 4x PY01-13-111 71-12066-00 PY01-13-460 	70-31414-10 	81-10380-00 PE01-10-602 43x56 A SL RD FPM 81-10474-00 SS50-11-312B 88x105 A SL LD FPM
2,5 WLAA	105 kW (143 PS)	BT-50	08/06-12/15		02-42284-01 	08-42296-01 			61-54190-00 WLAA-10-273B 94 Ø 0,82 mm MLS 61-54190-10 WLAA-10-271B 94 Ø 0,87 mm MLS 0 61-54190-20 WLAA-10-272B 94 Ø 0,92 mm MLS 	14-32370-01 WLS1-10-135B (10x) +WLS1-10-136B (4x) +WLS1-10-137A (4x) 	71-54286-00 WE01-10-235 	12-52829-06 KL02-10-155 (16x) 70-54282-00 KL02-10-155 16x 	71-54287-00 WE01-13-111 71-54288-00 WE01-13-460 	70-31414-10 	81-54283-00 WE01-10-602 60,5x77,35 A SL RD FPM/ACM 81-54284-00 WL51-11-399 90x110 A SL LD FPM 81-53459-00 2x RF03-12-603A 32x46 A SL LD MVQ
2,5 WL11	85 kW (115 PS)	MPV TD	05/96-09/99						61-53065-00 WL01-10-271B 94,5 Ø MLS 		15-52993-01 WL01-10-235 	12-52992-01 WL01-10-155 (12x) 70-52992-00 WL01-10-155 12x 	71-52994-00 WLS1-13-111 		81-53462-00 G601-11-399 90x110 A SL LD MVQ

MAZDA															
Ltr.															
2,6	G54B G6 4G54	73-92 kW (99-125 PS)	B-SERIE	09/86-05/99	01-52485-01 AM22-10-9Y0	02-52485-01			61-52485-00 AM21-10-271A 93 Ø		15-52236-01	12-52906-01 AM01-10-155 (8x)	71-52464-00 AM01-13-111A	71-52462-00 AM01-10-431	81-53322-10 AM01-11-399 80x96 A SL LD FPM
												 8x			
2,6	G6 (12V) G6Y0	90-115 kW (122-156 PS)	B-SERIE BT-50	01/90	01-52930-01 8AL1-10-271	02-52930-01 8AL1-10-235			61-52930-00 G601-10-271 93,5 Ø		15-52888-01 G601-10-235 +G601-10-231 (2x)	12-54023-02 B630-10-155 (12x)	71-52878-00 G601-13-111A	70-31414-10 	81-53342-00 90x110 A SL LD NBR
												 12x			
3,0	AJ AJ03	145-149 kW (197-203 PS)	TRIBUTE TRIBUTE V6	03/00-05/08	02-36875-02 AJ03-10-SF0 12/03	08-34338-01 AJ03-10-SHO 02/05		61-36875-00 R AJ03-10-271 MLS	14-32171-01 GY01-10-135A (16x)	71-38096-00 L AJ03-10-2D5	12-34343-01 GY01-10-155 (24x)	71-38103-00 AJ03-13-111B 6x	71-34338-00 AJ04-10-431A 02/05	81-34314-00 AJ03-10-602A 47,62x63,5 AB SL RD ACM	
											 24x				
					02-36875-05 01/04→	08-38094-01 03/05→		61-36880-00 L AJ03-10-272 MLS		71-38097-00 R AJ03-10-235	70-34343-00 GY01-10-155	71-38102-00 AJ03-13-135 12/03 6x	71-38094-00 ZZC1-10-431 03/05→	81-34318-00 AJ03-11-312A 91x108 AB LD NBR	
											 24x				
												71-34307-00 GY01-13-460A 2x	71-34307-00 GY01-13-460A 2x	81-34314-00 AJ03-10-602A 47,62x63,5 AB SL RD ACM	
3,0	AJ	147-152 kW (200-207 PS)	MPV	01/02-12/06				61-36875-00 R AJ03-10-271 MLS		71-38096-00 L AJ03-10-2D5	12-34343-01 GY01-10-155 (24x)	71-34307-00 GY01-13-460A 2x	71-34338-00 AJ04-10-431A 02/05	81-34314-00 AJ03-10-602A 47,62x63,5 AB SL RD ACM	
											 24x				
								61-36880-00 L AJ03-10-272 MLS		71-38097-00 R AJ03-10-235	70-34343-00 GY01-10-155	71-38094-00 ZZC1-10-431 03/05→	81-34318-00 AJ03-11-312A 91x108 AB LD NBR		
											 24x				

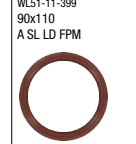







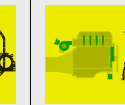

MAZDA

<p>Ltr.  3,0 AJ 149-152 kW (203-207 PS) TRIBUTE TRIBUTE V6 04/04-05/08 </p>		<p>02-36875-05</p> 	<p>08-34338-01 AJ03-10-SHO 11 → 02/05</p>  <p>08-38094-01 11 03/05 →</p> 		<p>61-36875-00 R AJ03-10-271 MLS</p>  <p>61-36880-00 L AJ03-10-272 MLS</p> 	<p>14-32171-01 GY01-10-135A (16x)</p> 	<p>71-38096-00 L AJ03-10-205</p>  <p>71-38097-00 R AJ03-10-235</p> 	<p>12-34343-01 GY01-10-155 (24x)</p>  <p>70-34343-00 GY01-10-155</p> 	<p>71-38103-00  6x AJ03-13-111B</p>  <p>71-10043-00  6x AJB4-13-135</p>  <p>71-34307-00  2x ZY01-10-431 GY01-13-460A</p> 	<p>71-34338-00 AJ04-10-431A 11 → 02/05</p>  <p>71-38094-00 ZZ01-10-431 11 03/05 →</p> 	<p>81-34314-00  AJ03-10-602A 47,62x63,5 AB SL RD ACM</p>  <p>81-34318-00  AJ03-11-312A 91x106 AB LD NBR</p> 
<p>3,0 HA 50-66 kW (68-90 PS)</p>	<p>01-52445-01 SE45-99-100</p> 				<p>61-52445-00 SE01-10-271 99,6 Ø</p> 		<p>71-52441-00 SE01-10-235</p>	<p>12-53027-01</p> 	<p>71-52443-00  4x SE01-13-461</p>	<p>10-52442-01 SE01-99-104</p>	<p>81-53361-00  51x70 A SL RD MVQ</p>  <p>81-53362-00  102x125 A SL OD MVQ</p> 
<p>3,0 WEAT 115 kW (156 PS) BT-50 BT-50 CDVI 10/06</p>		<p>02-42284-01</p> 	<p>08-42296-01</p> 		<p>61-54195-00 WE01-10-273B 97 Ø 0,95 mm MLS</p>  <p>61-54195-10 WE01-10-271B 97 Ø 1 mm MLS</p>  <p>61-54195-20 WE01-10-272B 97 Ø 1,05 mm MLS</p> 	<p>14-32370-01 WLS1-10-135B (10x) → WLS1-10-136B (4x) → WLS1-10-137A (4x)</p> 	<p>71-54286-00 WE01-10-235</p> 	<p>12-52829-06 KL02-10-155 (16x)</p>  <p>70-54282-00 KL02-10-155</p> 	<p>71-54287-00  4x WE01-13-111</p>  <p>71-54288-00  16x WE01-13-460</p> 	<p>70-31414-10</p> 	<p>81-54283-00  WE01-10-602 60,5x77,35 A SL RD FPM/ACM</p>  <p>81-54284-00  WLS1-11-399 90x110 A SL LD FPM</p>  <p>81-53459-00 N 2x RF03-12-603A 32x46 A SL LD MVQ</p> 

MAZDA

Ltr.  4,0 1V 99V
 154 kW (209 PS)
 B-SERIE
 11/05

[NEW]

				<p>61-11228-00 R 102.5 Ø 0,6 mm MLS</p> <p>61-11229-00 L 102.5 Ø 0,6 mm MLS</p>			<p>12-21058-01 70-21058-00 12x</p>	<p> 71-21055-00 2x</p> <p></p>	<p> 71-21085-00</p> <p></p>	
----------------------------------------------------------------------------------	----------------------------------------------------------------------------------	----------------------------------------------------------------------------------	-----------------------------------------------------------------------------------	---------------------------------------------------------------------------------------------------------------------------------------------------------------------------------------------------------------	------------------------------------------------------------------------------------	------------------------------------------------------------------------------------	---------------------------------------------------------	-----------------------------------------------------------------------------------------------------------------------------------------------------------------------------------------------------	--------------------------------------------------------------------------------------------------------------------------------------------------------------------------------------------------	------------------------------------------------------------------------------------

Haftungsausschluss

(für Katalog)

Alle Angaben in unserem Katalog wurden von uns sorgfältig geprüft, sind jedoch unverbindlich. Ersatzansprüche wegen Katalogangaben werden von uns nicht anerkannt. Der Käufer ist selbst verpflichtet, zu prüfen, ob unsere Teile für seine Zwecke geeignet sind. In allen Zweifelsfällen sollte Rücksprache mit unserem technischen Kundendienst erfolgen **Tel. +49 731 7046 999**.

Technische Weiterentwicklungen oder Änderungen bleiben vorbehalten, soweit damit keine Nachteile für den Kunden verbunden sind.

Angaben, Namens- und Markenzeichen, Beschreibungen, Nummern von Fahrzeugnummern und Herstellerzeichen, Original-Ersatzteilnummern der Fahrzeug- und Motorenhersteller u. a. sind ausschließlich für interne Zwecke gedacht. Solche Kennzeichnungen dürfen Fahrzeugbesitzern gegenüber nicht verwendet werden.

Wir weisen ausdrücklich darauf hin, dass alle von uns gelieferten Teile von geschultem Fachpersonal einzubauen sind. Reinz haftet für Fehler in diesem Katalog nur, wenn diese für den Kunden nicht offenbar erkennbar sind sowie nur bei Vorsatz und grober Fahrlässigkeit von Reinz, eines Vertreters oder eines Erfüllungsgehilfen. Dieser Haftungsausschluss gilt nicht im Rahmen

des Anwendungsbereichs des Produkthaftungsgesetzes und nicht bei Verletzung von Körper, Leben und Gesundheit, sowie bei der Verletzung von sog. Kardinalpflichten. Darüber hinaus ist unsere Haftung für Schäden, insbesondere für Personen-, Sach- oder Vermögensschäden, die unmittelbar oder mittelbar im Zusammenhang mit der Nutzung dieses Kataloges auftreten, sowie für nicht voraussehbare Schäden ausgeschlossen.

Reinz ist Inhaber aller Schutzrechte an den in diesem Katalog gespeicherten Daten. Kopie, Nachdruck, ganze oder teilweise Übernahme der Inhalte und Vervielfältigung, auch auszugsweise, ist nur mit unserer vorheriger schriftlicher Zustimmung sowie mit unserem Urheberrechtsvermerk zulässig.

Für Bestellungen, welche ab dem Erscheinungsdatum eines neuen Katalogs getätigt werden, sind alleine die Angaben des neuen Katalogs maßgeblich. Auf Angaben im Vorkatalog kann bei Neubestellungen nicht mehr zurückgegriffen werden.

Sofern Sie noch Fragen haben, bitten wir Sie, sich mit uns in Verbindung zu setzen.

VictorReinz.com/AGB

Exclusion of Liability

(for catalog)

All details in our catalog have been thoroughly checked by us but are however not binding. Right to damages on account of catalog details will not be recognized. The purchaser is obliged to check if our parts are suitable for their use. In all doubtful cases, the purchaser should consult our technical customer service under **+49 731 7046 999**.

We reserve the right to further technical developments or changes as long as no disadvantage for the customer results.

Details, name and trademarks, descriptions, numbers from vehicle numbers and manufacturer symbols, original vehicle replacement part numbers and engine manufacturer etc. are solely for internal use. Such labels must not be used with vehicle owners.

We specifically point out that all parts supplied by us must be assembled by trained specialists.

Reinz is liable for mistakes in this catalog only when they are not clearly recognizable for the customer, as well as by intent or gross negligence on the part of Reinz, its representative or vicarious agent. This exclusion of liability does not apply within the framework of the field of

application of the product liability laws and not by bodily harm, life and health, as well as by violation of cardinal duties. In addition, our liability for damages, especially personal, property or financial damages that occur directly or indirectly as a result of the use of this catalog, as well as non-foreseeable damages are excluded.

Reinz is the owner of all patent rights on the data stored in this catalog. Copies, reprints, whole or partial takeover of the contents and duplication even in excerpts are only permissible with our prior written approval, as well as with our copyright note.

For orders placed after the publication date of a new catalog, only the details in the new catalog are binding and no fall back to details in the previous catalog is possible.

In case you have further questions, do not hesitate to contact us.

VictorReinz.com/AGB

VictorReinz.com

reinz.info@dana.com

Technical Hotline +49 (0)731 7046-9 99

REINZ-Dichtungs-GmbH

Reinzstrasse 3-7
89233 Neu-Ulm
Germany
+49 (0)731 7046-0

VICTOR REINZ[®]

