

**VICTOR REINZ®**

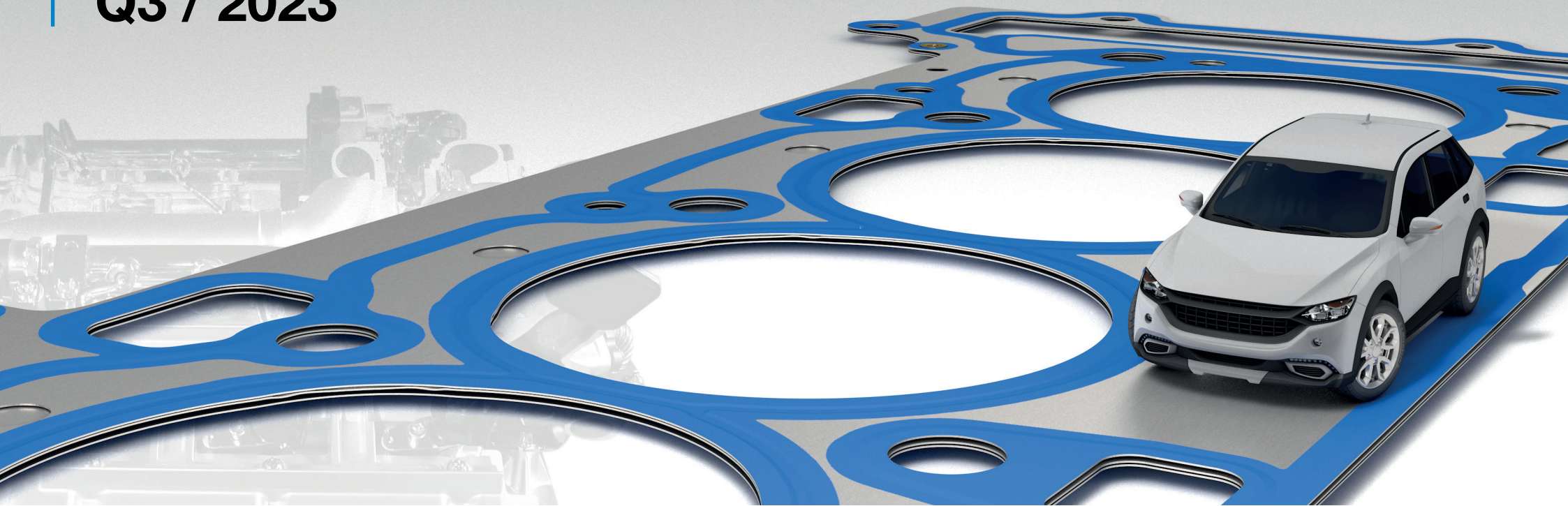

**MINI**  
**Q3 / 2023**



**[VictorReinz.com/online-catalog](https://VictorReinz.com/online-catalog)**

# Victor Reinz®

## at a Glance



### Online Catalog

[VictorReinz.com/online-catalog](https://VictorReinz.com/online-catalog)



### Newsletter

[VictorReinz.com/EN/News/Newsletter.aspx?region](https://VictorReinz.com/EN/News/Newsletter.aspx?region)



### Youtube

[www.youtube.com/user/VictorReinzSealingEN](https://www.youtube.com/user/VictorReinzSealingEN)



### Catalog News

[VictorReinz.com/news](https://VictorReinz.com/news)



### Technical Service Information

[VictorReinz.com/tsi](https://VictorReinz.com/tsi)



### Facebook

[www.facebook.com/VictorReinzParts](https://www.facebook.com/VictorReinzParts)



### Just seal it!

[VictorReinz.com/jsi](https://VictorReinz.com/jsi)



### Technical Datasheet

[VictorReinz.com/jsi-datasheet](https://VictorReinz.com/jsi-datasheet)



### LinkedIn

[www.linkedin.com/showcase/victor-reinz-emea](https://www.linkedin.com/showcase/victor-reinz-emea)



### Safety Datasheet

[VictorReinz.com/jsi-datasheet](https://VictorReinz.com/jsi-datasheet)



### Homepage

[VictorReinz.com](https://VictorReinz.com)



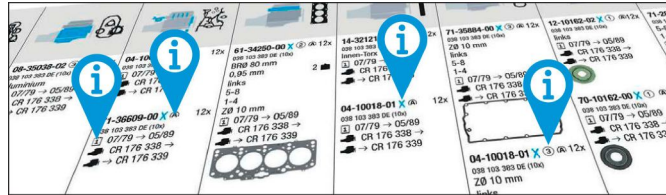

[VictorReinz.com/catalog-info](https://www.victorreinz.com/catalog-info)

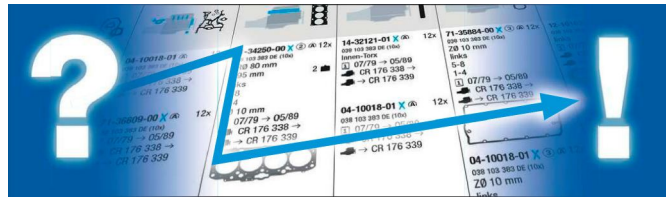

[VictorReinz.com/catalog-how-to-use](https://www.victorreinz.com/catalog-how-to-use)

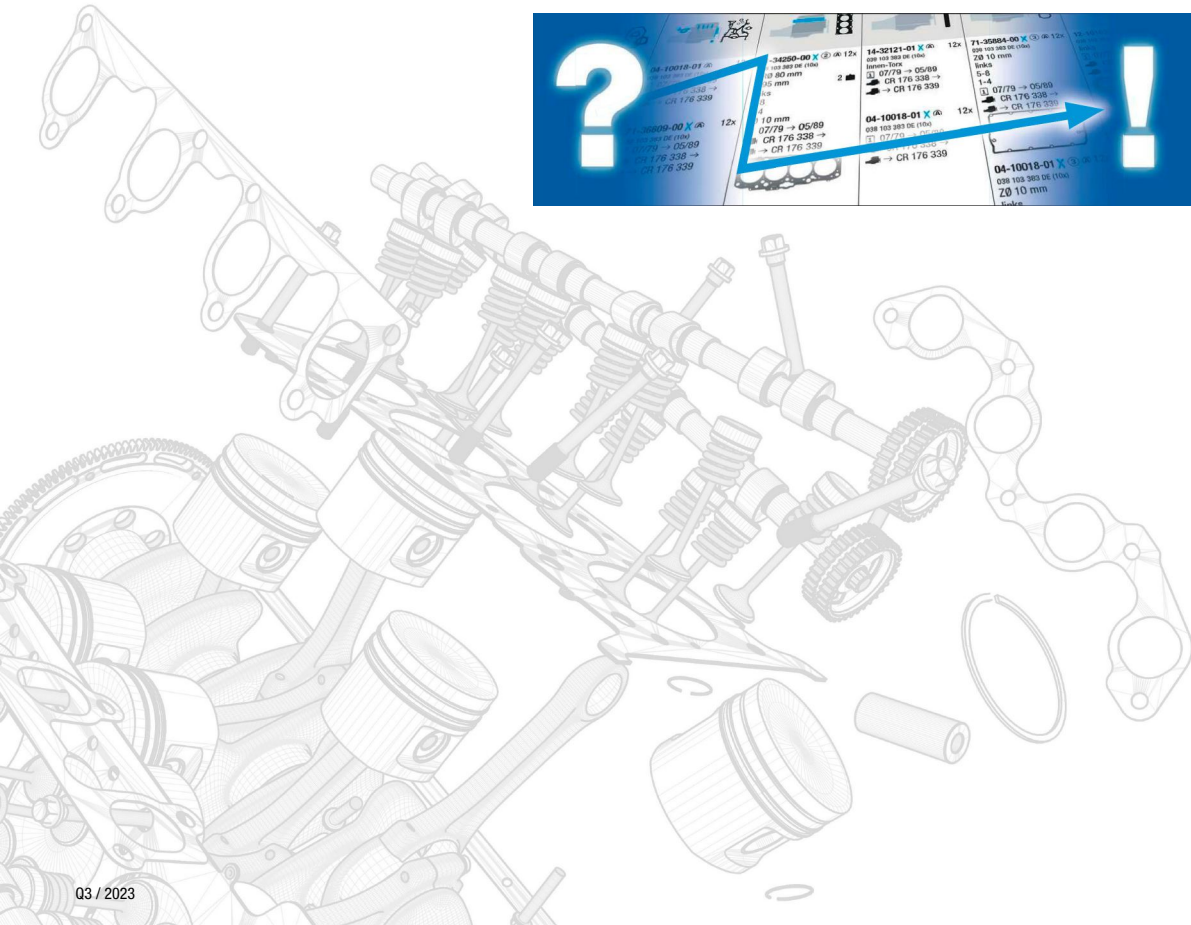

# MINI



**0-9**

1ND ..... 7  
 1ND-TV ..... 7  
 9HZ (DV6TED4) ..... 15

**B**

















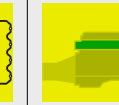
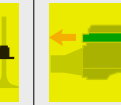
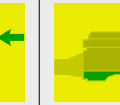

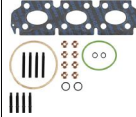

















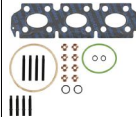

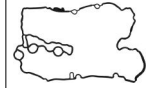
B36 A15 A ..... 7-8  
 B37 C15 A ..... 8  
 B38 A12 A ..... 5  
 B38 A15 A ..... 8-10  
 B46 A20 A ..... 15-16  
 B47 C20 A ..... 17  
 B47 C20 B ..... 17  
 B48 A20 A ..... 17-18  
 B48 A20 B ..... 16, 18  
 B48 A20 E ..... 18  
 B48 A20 F ..... 19

**N**

N12 B14 A ..... 6  
 N12 B16 A ..... 11  
 N14 B16 A ..... 11  
 N14 B16 AB ..... 11  
 N14 B16 C ..... 11-12  
 N16 B16 A ..... 12  
 N18 B16 A ..... 13  
 N18 B16 B ..... 13  
 N18 B16 C ..... 13  
 N47 C16 A ..... 14  
 N47 C20 A ..... 19

**W**

W10 B14 A ..... 6  
 W10 B16 A ..... 14  
 W11 B16 A ..... 14  
 W16 D16 (9HZ) ..... 15  
 W17 D14 (1ND) ..... 7

MINI															
1,2	B38 A12 A	55-75 kW (75-102 PS)	ONE FIRST (F55) ONE FIRST (F56) ONE (F55) ONE (F56)	04/14-10/17				<p><b>04-10336-01</b> </p>  <p><b>61-38185-00</b> 11 12 8 636 960 79 Ø 0,7 mm MLS  ⇒ 07/15</p> <p><b>61-38185-10</b> 11 12 8 636 961 79 Ø 1 mm MLS  ⇒ 07/15</p> <p><b>61-10197-00</b> 11 12 8 656 975 79 Ø 0,7 mm MLS  08/15→</p> <p><b>61-10197-10</b> 11 12 8 656 976 79 Ø 1 mm MLS  08/15→</p>	<p><b>14-12261-01</b> 1x</p> 	<p><b>71-12440-00</b> 11 12 8 618 514</p> 	<p><b>12-36866-03</b> 11 34 0 038 719  ⇒ 07/15</p>  <p><b>12-37256-03</b> 11 34 0 038 720  08/15→</p> 	<p><b>71-11403-00</b>  3x</p> <p>11 61 7 633 493</p>  <p><b>71-12264-00</b> </p> <p>11 65 7 618 035</p> 	<p><b>70-31414-10</b></p> 	<p><b>81-10448-00</b> </p> <p>11 14 8 602 594 90x104 LD PTFE ACM</p> 	
1,2	B38 A12 A	75 kW (102 PS)	CABRIOLET ONE (F57)	06/15-10/17				<p><b>04-10336-01</b> </p>  <p><b>61-10197-00</b> 11 12 8 656 975 79 Ø 0,7 mm MLS</p> <p><b>61-10197-10</b> 11 12 8 656 976 79 Ø 1 mm MLS</p>	<p><b>14-12261-01</b> 1x</p> 	<p><b>71-12440-00</b> 11 12 8 618 514</p> 	<p><b>12-36866-03</b> 11 34 0 038 719</p>  <p><b>12-37256-03</b> 11 34 0 038 720</p> 	<p><b>71-11403-00</b>  3x</p> <p>11 61 7 633 493</p>  <p><b>71-12264-00</b> </p> <p>11 65 7 618 035</p> 	<p><b>70-31414-10</b></p> 	<p><b>81-10448-00</b> </p> <p>11 14 8 602 594 90x104 LD PTFE ACM</p> 	

MINI														
Ltr.														
1,4	N12 B14 A	55-70 kW (75-95 PS)	CLUBMAN ONE (R55) ONE LPG (R56) ONE (R56)	11/06-03/10	<p><b>02-38005-01</b> 11 12 0 427 689 +11 12 7 570 859</p> <p><b>02-38005-02</b> 11 12 0 427 689</p> <p><b>02-38005-03</b> 11 12 0 427 689</p>			<p><b>61-38005-00</b> 11 12 7 595 139 78 Ø 0,9 mm MLS</p> <p><b>61-38005-10</b>  11 12 7 570 860 78 Ø 1,2 mm MLS</p>	<p><b>14-32347-01</b> 11 12 7 560 274</p>	<p><b>15-37633-01</b> 11 12 7 567 877</p>	<p><b>12-37621-01</b> 11 34 0 033 950</p> <p><b>70-37621-00</b></p>	<p><b>11-37632-01</b>  11 61 7 528 173</p> <p><b>71-41213-00</b>  18 40 7 563 111</p>	<p><b>70-31414-10</b></p>	<p><b>81-41219-00</b> </p> <p>11 11 7 568 264 61x75 A SL RD PTFE (Polytetrafluorethylen)/ACM (Polyacryl-Kautschuk)</p> <p><b>81-38532-00</b> </p> <p>11 11 7 568 263 85x105 A SL LD PTFE (Polytetrafluorethylen)/ACM (Polyacryl-Kautschuk)</p>
1,4	W10 B14 A	55 kW (75 PS)	ONE (R50, R53)	04/03-09/06 <b>[NEW]</b>	<p><b>02-34787-01</b> 11 12 7 508 545</p>	<p><b>08-34786-01</b> 11 11 7 508 534  → 07/04</p> <p><b>08-34786-02</b> 11 11 0 147 562  08/04 →</p>		<p><b>61-34980-00</b> 11 12 7 508 543 78 Ø 0,65 mm MLS</p> <p><b>61-34980-10</b> 11 12 7 508 544 78 Ø 0,95 mm MLS</p>	<p><b>14-32241-01</b> 07 13 1 487 226 (10x)</p>	<p><b>15-34787-01</b> 11 12 1 485 838 +11 12 7 513 066 (4x)</p> <p><b>71-34787-00</b></p>	<p><b>12-34783-01</b> 11 34 0 029 571(16x)</p>	<p><b>71-34784-00</b>  4x 11 61 7 513 044</p> <p><b>71-34782-00</b>  11 62 1 174 968</p>	<p><b>71-34786-00</b> 11 13 1 487 221</p>	<p><b>81-34805-00</b> </p> <p>11 11 1 485 171 32x45 A SL RD ACM</p> <p><b>81-10673-00</b> </p> <p>11 11 1 482 244 91x111 AB LD FPM</p>

MINI														
Ltr.														
1,4	W17 D14 (1ND) 55-65 kW (75-88 PS) 1ND 1ND-TV	ONE D (R50, R53)	06/03	<b>01-53558-01</b> 11 11 7 790 935 [1] ⇒ 09/05 	<b>02-53558-01</b> 11 12 7 790 936 [1] ⇒ 09/05 			<b>61-53375-00</b> 11 12 7 790 954 74,6 Ø 0,95 mm MLS [1] ⇒ 09/05 3		<b>71-53558-00</b> 11 12 7 792 374 	<b>12-53457-01</b> 11 34 7 791 053 (8x) 	<b>71-34191-00</b> 11 65 7 791 076 	<b>81-53508-00 K</b> 11 14 7 790 962 38x50 A SL RD FPM/ACM 	
				<b>61-53375-10</b> 11 12 7 790 955 74,6 Ø 1 mm MLS [1] ⇒ 09/05 4				<b>61-53375-20</b> 11 12 7 790 956 74,6 Ø 1,05 mm MLS [1] ⇒ 09/05 5					<b>81-53313-00 K</b> 11 14 7 790 960 75x107 A SL LD MVQ 	
1,5	B36 A15 A 100 kW (136 PS)	CABRIOLET COOPER (F57) CLUBMAN COOPER (F54) COOPER (F55) COOPER (F56)	09/13		<b>02-38180-01</b> 		<b>04-10336-01</b> 	<b>61-42180-00</b> 11 12 8 630 683 83 Ø 0,7 mm MLS [1] 08/15→ 1	<b>14-12261-01</b> 	<b>71-11406-00</b> 11 12 8 618 515 	<b>12-36866-03</b> 11 34 0 038 719 	<b>71-11403-00</b> 11 61 7 633 493 3x 	<b>70-31414-10</b> 	<b>81-10448-00 K</b> 11 14 8 602 594 90x104 LD PTFE ACM 
								<b>61-42180-10</b> 11 12 8 630 684 83 Ø 1 mm MLS [1] 08/15→ 			<b>12-37256-03</b> 11 34 0 038 720 	<b>71-12264-00</b> 11 65 7 618 035 		
1,5	B36 A15 A 100 kW (136 PS)	CLUBMAN COOPER ALL4 (F54)	08/16		<b>02-38180-01</b> 			<b>61-42180-00</b> 11 12 8 630 683 83 Ø 0,7 mm MLS 1	<b>14-12261-01</b> 	<b>71-11406-00</b> 11 12 8 618 515 	<b>12-36866-03</b> 11 34 0 038 719 	<b>71-11403-00</b> 11 61 7 633 493 3x 	<b>70-31414-10</b> 	<b>81-10448-00 K</b> 11 14 8 602 594 90x104 LD PTFE ACM 
								<b>61-42180-10</b> 11 12 8 630 684 83 Ø 1 mm MLS 			<b>12-37256-03</b> 11 34 0 038 720 	<b>71-12264-00</b> 11 65 7 618 035 		





















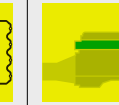
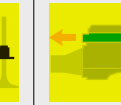
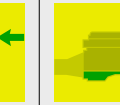



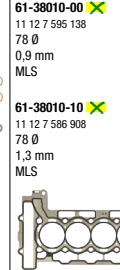



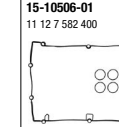
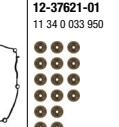



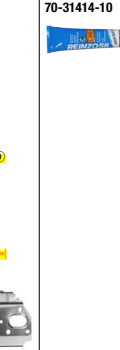



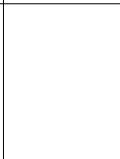

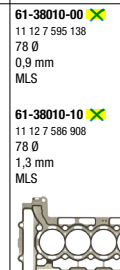

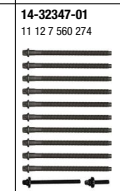
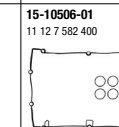
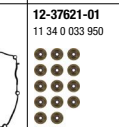



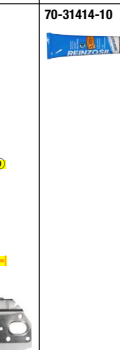

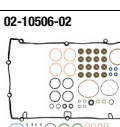

MINI															
Ltr.															
1,5	B38 A15 A	75-100 kW (102-136 PS)	CABRIOLET COOPER (F57) CLUBMAN ONE (F54)	11/14											
					02-38180-01 			04-10336-01 	61-42180-00 11 12 8 630 683 83 Ø 0,7 mm MLS 	14-12261-01 	71-11406-00 11 12 8 618 515 	12-36866-03 11 34 0 038 719  6x 70-37256-03 11 34 0 038 720  6x 70-36866-00 ES 6x 70-37256-00 AS 6x	71-11403-00 11 61 7 633 493 3x 71-12264-00 11 65 7 618 035 	70-31414-10 	81-10448-00 11 14 8 602 594 90x104 LD PTFE ACM 
1,5	B38 A15 A	100 kW (136 PS)	CLUBMAN COOPER (F54)	12/14				04-10336-01 	61-42180-00 11 12 8 630 683 83 Ø 0,7 mm MLS 08/15→ 61-42180-10 11 12 8 630 684 83 Ø 1 mm MLS 08/15→ 	14-12261-01 	71-11406-00 11 12 8 618 515 	12-36866-03 11 34 0 038 719  6x 70-37256-03 11 34 0 038 720  6x 70-36866-00 ES 6x 70-37256-00 AS 6x	71-11403-00 11 61 7 633 493 3x 71-12264-00 11 65 7 618 035 	70-31414-10 	81-10448-00 11 14 8 602 594 90x104 LD PTFE ACM 

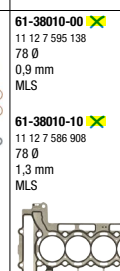

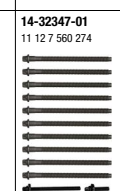
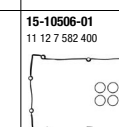
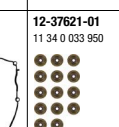
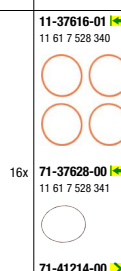
MINI															
1,6	N12 B16 A	85-88 kW (115-120 PS)	CABRIOLET COOPER (R57) CLUBMAN COOPER (R55) COOPER (R56)	09/06-12/13	 <b>02-38005-01</b> 11 12 0 427 689 +11 12 7 570 859	 <b>02-38005-02</b> 11 12 0 427 689	 <b>02-38005-03</b> 11 12 0 427 689	 <b>61-38005-00</b> 11 12 7 595 139 78 Ø 0,9 mm MLS	 <b>61-38005-10</b> ✕ 11 12 7 570 860 78 Ø 1,2 mm MLS	 <b>14-32347-01</b> 11 12 7 560 274	 <b>15-37633-01</b> 11 12 7 567 877	 <b>12-37621-01</b> 11 34 0 033 950	 <b>11-37632-01</b> ✕ 11 61 7 528 173	 <b>70-31414-10</b>	 <b>81-41219-00</b> ✕ 11 11 7 568 264 61x75 A SL RD PTFE (Polytetrafluorethylen)/ACM (Polyacryl-Kautschuk)
1,6	N14 B16 A N14 B16 AB N14 B16 C	120-155 kW (163-211 PS)	CABRIOLET COOPER S (R57) CABRIOLET JCW (R57) CLUBMAN COOPER S (R55) CLUBMAN JCW (R55) COOPER S (R56) COUPE JCW (R58) JCW (R56)	10/06-06/15	 <b>02-38010-01</b> 11 12 0 427 690 +11 12 7 560 276	 <b>02-38010-02</b> 11 12 0 427 690	 <b>04-10230-01</b> Ⓜ	 <b>61-38010-00</b> 11 12 7 595 138 78 Ø 0,9 mm MLS	 <b>61-38010-10</b> ✕ 11 12 7 586 908 78 Ø 1,3 mm MLS	 <b>14-32347-01</b> 11 12 7 560 274	 <b>15-37614-01</b> 11 12 7 572 851	 <b>12-37621-01</b> 11 34 0 033 950	 <b>11-37616-01</b> ✕ 11 61 7 528 340	 <b>70-31414-10</b>	 <b>81-41219-00</b> ✕ 11 11 7 568 264 61x75 A SL RD PTFE (Polytetrafluorethylen)/ACM (Polyacryl-Kautschuk)
					 <b>02-38005-01</b> 11 12 0 427 689 +11 12 7 570 859	 <b>02-38005-02</b> 11 12 0 427 689	 <b>02-38005-03</b> 11 12 0 427 689	 <b>61-38005-00</b> 11 12 7 595 139 78 Ø 0,9 mm MLS	 <b>61-38005-10</b> ✕ 11 12 7 570 860 78 Ø 1,2 mm MLS	 <b>14-32347-01</b> 11 12 7 560 274	 <b>15-37633-01</b> 11 12 7 567 877	 <b>12-37621-01</b> 11 34 0 033 950	 <b>11-37632-01</b> ✕ 11 61 7 528 173	 <b>70-31414-10</b>	 <b>81-41219-00</b> ✕ 11 11 7 568 263 85x105 A SL LD PTFE (Polytetrafluorethylen)/ACM (Polyacryl-Kautschuk)
					 <b>02-38010-01</b> 11 12 0 427 690 +11 12 7 560 276	 <b>02-38010-02</b> 11 12 0 427 690	 <b>04-10230-01</b> Ⓜ	 <b>61-38010-00</b> 11 12 7 595 138 78 Ø 0,9 mm MLS	 <b>61-38010-10</b> ✕ 11 12 7 586 908 78 Ø 1,3 mm MLS	 <b>14-32347-01</b> 11 12 7 560 274	 <b>15-37614-01</b> 11 12 7 572 851	 <b>12-37621-01</b> 11 34 0 033 950	 <b>11-37616-01</b> ✕ 11 61 7 528 340	 <b>70-31414-10</b>	 <b>81-41219-00</b> ✕ 11 11 7 568 263 85x105 A SL LD PTFE (Polytetrafluorethylen)/ACM (Polyacryl-Kautschuk)

MINI													
1,6	N14 B16 C	155 kW (211 PS)	ROADSTER JCW (R59)	11/11-04/15	 <b>02-38010-01</b> 11 12 0 427 690 +11 12 7 560 276  <b>02-38010-02</b> 11 12 0 427 690 	 <b>61-38010-00</b> 11 12 7 595 138 78 Ø 0,9 mm MLS <b>61-38010-10</b> 11 12 7 586 908 78 Ø 1,3 mm MLS 	 <b>14-32347-01</b> 11 12 7 560 274 	 <b>15-37614-01</b> 11 12 7 572 851 	 <b>12-37621-01</b> 11 34 0 033 950  <b>70-37621-00</b> 	 <b>11-37616-01</b> 11 61 7 528 340  <b>71-41214-00</b> 11 62 7 626 106 	 <b>70-31414-10</b> 	 <b>81-41219-00 K</b> 11 11 7 568 264 61x75 A SL RD PTFE (Polytetrafluorethylen)/ACM (Polyacryl-Kautschuk)  <b>81-38532-00 K</b> 11 11 7 568 263 85x105 A SL LD PTFE (Polytetrafluorethylen)/ACM (Polyacryl-Kautschuk) 	
1,6	N16 B16 A	55-90 kW (75-122 PS)	CABRIOLET COOPER (R57) CABRIOLET ONE (R57) CLUBMAN COOPER (R55) CLUBMAN ONE (R55) CLUBMAN COOPER (R55) CLUBMAN ONE (R55) COOPER (R56) COUNTRYMAN COOPER ALL 4 (R60) COUNTRYMAN COOPER (R60) COUNTRYMAN ONE (R60) COUPE COOPER (R58) ONE (R56) PACEMAN COOPER ALL4 (R61) PACEMAN COOPER (R61) ROADSTER COOPER (R59)	09/06-10/16	 <b>02-37633-01</b> 	 <b>61-38005-00</b> 11 12 7 595 139 78 Ø 0,9 mm MLS <b>61-38005-10</b> 11 12 7 570 860 78 Ø 1,2 mm MLS 	 <b>14-32347-01</b> 11 12 7 560 274 	 <b>15-37633-01</b> 11 12 7 567 877 	 <b>12-37621-01</b> 11 34 0 033 950  <b>71-37631-00</b> 11 61 7 528 174  <b>71-41213-00</b> 18 40 7 563 111 	 <b>70-31414-10</b> 	 <b>81-41219-00 K</b> 11 11 7 568 264 61x75 A SL RD PTFE (Polytetrafluorethylen)/ACM (Polyacryl-Kautschuk)  <b>81-38532-00 K</b> 11 11 7 568 263 85x105 A SL LD PTFE (Polytetrafluorethylen)/ACM (Polyacryl-Kautschuk) 		

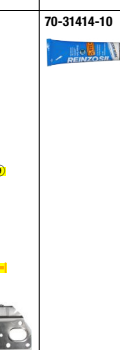
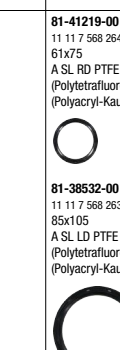

MINI														
1,6	N18 B16 A N18 B16 B	90-160 kW (122-218 PS)	CABRIOLET COOPER S (R57) CLUBMAN COOPER S (R55) CLUBMAN COOPER S (R55) COOPER S (R56) COOPER S (R56) COUNTRYMAN COOPER ALL4 (R60) COUNTRYMAN COOPER S ALL4 (R60) COUNTRYMAN COOPER S (R60) COUPE COOPER S (R58) PACEMAN COOPER ALL4 (R61) PACEMAN COOPER S ALL4 (R61) PACEMAN COOPER S (R61) ROADSTER COOPER S (R59)	10/07	 02-10506-02		 04-10230-01 	 61-38010-00  11 12 7 595 138 78 Ø 0,9 mm MLS 61-38010-10  11 12 7 586 908 78 Ø 1,3 mm MLS	 14-32347-01 11 12 7 560 274	 15-10506-01 11 12 7 582 400	 12-37621-01 11 34 0 033 950	 11-37616-01  11 61 7 528 340 71-37628-00  11 61 7 528 341 71-41214-00  11 62 7 626 106	 70-31414-10	 81-41219-00  11 11 7 568 264 61x75 A SL RD PTFE (Polytetrafluorethylen)/ACM (Polyacryl-Kautschuk) 81-38532-00  11 11 7 568 263 85x105 A SL LD PTFE (Polytetrafluorethylen)/ACM (Polyacryl-Kautschuk)
1,6	N18 B16 C	155 kW (211 PS)	ROADSTER JCW (R59)	11/11-04/15	 02-10506-02		 04-10230-01 	 61-38010-00  11 12 7 595 138 78 Ø 0,9 mm MLS 61-38010-10  11 12 7 586 908 78 Ø 1,3 mm MLS	 14-32347-01 11 12 7 560 274	 15-10506-01 11 12 7 582 400	 12-37621-01 11 34 0 033 950 70-37621-00 16x	 11-37616-01  11 61 7 528 340 71-37628-00  11 61 7 528 341 71-41214-00  11 62 7 626 106	 70-31414-10	 81-41219-00  11 11 7 568 264 61x75 A SL RD PTFE (Polytetrafluorethylen)/ACM (Polyacryl-Kautschuk) 81-38532-00  11 11 7 568 263 85x105 A SL LD PTFE (Polytetrafluorethylen)/ACM (Polyacryl-Kautschuk)
1,6	N18 B16 C	160 kW (218 PS)	COUNTRYMAN COOPER S JCW (R60) JCW (R56) PACEMAN JCW (R61)	09/12-10/16	 02-10506-02		 04-10230-01 	 61-38010-00  11 12 7 595 138 78 Ø 0,9 mm MLS 61-38010-10  11 12 7 586 908 78 Ø 1,3 mm MLS	 14-32347-01 11 12 7 560 274	 15-10506-01 11 12 7 582 400	 12-37621-01 11 34 0 033 950 70-37621-00 16x	 11-37616-01  11 61 7 528 340 71-37628-00  11 61 7 528 341 71-41214-00  11 62 7 626 106	 70-31414-10	 81-41219-00  11 11 7 568 264 61x75 A SL RD PTFE (Polytetrafluorethylen)/ACM (Polyacryl-Kautschuk) 81-38532-00  11 11 7 568 263 85x105 A SL LD PTFE (Polytetrafluorethylen)/ACM (Polyacryl-Kautschuk)

















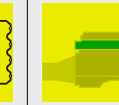
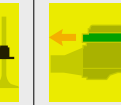
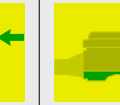







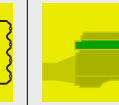
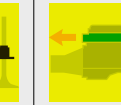
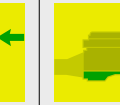





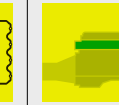
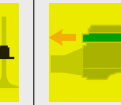
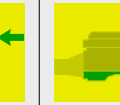

MINI															
1,6	N47 C16 A	66-82 kW (90-112 PS)	CABRIOLET COOPER D (R57) CLUBMAN COOPER D (R55) CLUBVAN ONE D (R55) CLUBVAN COOPER D (R55) COOPER D (R56) COUNTRYMAN COOPER D ALL4 (R60) COUNTRYMAN COOPER D (R60) COUNTRYMAN ONE D (R60) ONE D (R56) PACEMAN COOPER D ALL4 (R61) PACEMAN COOPER D (R61)	05/09-10/16											
Ltr.															
1,6	W10 B16 A	66-85 kW (90-116 PS)	CABRIOLET COOPER (R52) CABRIOLET ONE (R52) COOPER (R50, R53) ONE (R50, R53)	06/01-07/08 <b>[NEW]</b>											
1,6	W11 B16 A	120-160 kW (163-218 PS)	CABRIOLET COOPER S (R52) CABRIOLET JCW (R52) COOPER S (R50, R53) JCW (R50, R53) WORKS (R50, R53) WORKS S (R50, R53)	03/02-07/08 <b>[NEW]</b>											

MINI																			
1,6	W16 D16 (9HZ) 66-80 kW (90-109 PS) 9HZ (DV6TED4)	CLUBMAN COOPER D (R55) COOPER D (R56) ONE D (R56)	11/06-09/10	 02-36567-01	 04-10043-01	 61-36265-00 11 12 7 805 931 76 Ø 1,25 mm MLS	 61-36265-10 11 12 7 805 932 76 Ø 1,3 mm MLS	 61-36265-20 11 12 7 805 933 76 Ø 1,35 mm MLS	 61-36265-30 11 12 7 805 934 76 Ø 1,4 mm MLS	 61-36265-40 11 12 7 805 935 76 Ø 1,45 mm MLS	 14-32206-01 11 12 7 805 936 (10x)	 71-36567-00 11 12 7 805 927	 12-36587-01 11 34 7 805 970 (16x)	 11-11022-01	 70-31414-10	 81-35554-00 K 11 11 7 805 945 40x55 A SL RD PTFE ACM	 81-35553-00 K 11 11 7 805 946 85x105 A SL LD PTFE ACM	 81-35552-00 N 11 31 7 805 964 27x47 A SL RD PTFE ACM	
2,0	B46 A20 A 120-141 kW (163-192 PS)	COUNTRYMAN COOPER S ALL4 (F60) COUNTRYMAN COOPER S (F60)	10/16			 61-10076-00 11 12 8 654 272 82 Ø 0,7 mm MLS	 61-10076-10 11 12 8 654 273 82 Ø 1 mm MLS				 14-12261-02	 71-11411-00 11 12 8 618 519	 12-36866-03 11 34 0 038 719	 71-11403-00	 71-11394-00	 70-31414-10			
2,0	B46 A20 A 131 kW (178 PS)	CLUBMAN COOPER S (F54)	11/20	 02-11346-01	 08-11346-01	 61-10166-00 83 Ø 0,8 mm MLS	 61-10166-10 83 Ø 1,1 mm MLS				 14-12261-02	 15-11221-01 71-17437-00	 12-36866-03 11 34 0 038 719	 71-11403-00	 71-17430-00	 70-31414-10	 81-37002-00 K 11 11 8 604 931 55x68 AB RD PTFE	 81-10448-00 K 11 14 8 602 594 90x104 LD PTFE ACM	

[NEW]



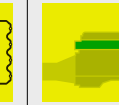
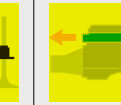
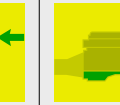

MINI															
2,0	B47 C20 A	100-140 kW (136-190 PS)	COUNTRYMAN COOPER D ALL4 (F60) COUNTRYMAN COOPER D (F60) COUNTRYMAN COOPER SD ALL4 (F60) COUNTRYMAN COOPER SD (F60)	10/16											
2,0	B47 C20 A B47 C20 B	100-140 kW (136-190 PS)	CABRIOLET COOPER SD (F57) CLUBMAN COOPER D (F54) CLUBMAN COOPER SD ALL4 (F54) CLUBMAN COOPER SD (F54) CLUBMAN COOPER SDX ALL4 (F54) COOPER (F56) COOPER SD (F55) COOPER SD (F56)	09/13											
2,0	B48 A20 A	120-155 kW (163-211 PS)	CABRIOLET COOPER S (F57) CABRIOLET COOPER S JCW (F57) CLUBMAN COOPER S ALL4 (F54) CLUBMAN COOPER S (F54) CLUBMAN COOPER S JCW (F54) CLUBMAN COOPER SX (F54) COOPER S (F55) COOPER S (F56) COOPER S JCW (F55) COOPER S JCW (F56) COUNTRYMAN COOPER S ALL4 (F60) COUNTRYMAN COOPER S (F60)	09/13											

02-10188-01

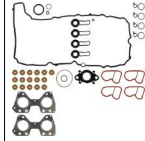

02-10188-01

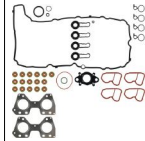

61-10188-00

11 12 8 513 699

85 Ø

1,3 mm

MLS



61-10188-10

11 12 8 513 700

85 Ø

1,4 mm

MLS



61-10188-20

11 12 8 513 701

85 Ø

1,5 mm

MLS



14-10398-01

11 12 8 513 128



15-10045-01

11 12 8 583 293

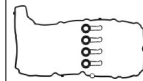

12-39398-01

11 34 7 807 347



70-39398-00

16x



71-11831-00

11 61 8 571 001



70-31414-10

11 11 7 802 665

55x68

RD FPM



81-39382-00

11 11 7 802 665

55x68

RD FPM



81-39379-00

11 14 7 797 490

90x104

LD FPM



61-10076-00

11 12 8 654 272

82 Ø

0,7 mm

MLS

61-10076-10

11 12 8 654 273

82 Ø

1 mm

MLS

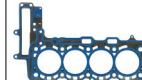

14-12261-02



71-11411-00

11 12 8 618 519

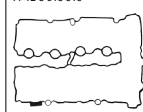

12-36866-03

11 34 0 038 719



12-37256-01

11 34 0 035 853

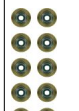

70-36866-00 ES

8x



70-37256-00 AS

8x



71-11403-00

11 61 7 633 493



71-11394-00

11 62 7 617 523

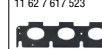

70-31414-10

11 11 7 802 665

55x68

AB RD PTFE

90x104

LD PTFE ACM



81-37002-00

11 11 7 804 931

55x68

AB RD PTFE

90x104

LD PTFE ACM



81-10448-00

11 14 8 602 594

90x104

LD PTFE ACM



MINI

Ltr. 2,0 B48 A20 A 141 kW (192 PS) COOPER S (F55) COOPER S (F56) 09/13



2,0 B48 A20 A 141 kW (192 PS) COOPER S (F55) COOPER S (F56) 09/13

61-38195-00  
11 12 8 627 107  
83 Ø  
0,7 mm  
MLS  
 ⇒ 07/15

61-38195-10  
11 12 8 627 108  
83 Ø  
1 mm  
MLS  
 ⇒ 07/15

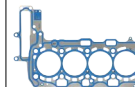

61-10076-00  
11 12 8 654 272  
82 Ø  
0,7 mm  
MLS  
 08/15→

61-10076-10  
11 12 8 654 273  
82 Ø  
1 mm  
MLS  
 08/15→

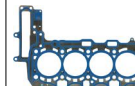

14-12261-02

71-11411-00  
11 12 8 618 519

12-36866-03  
11 34 0 038 719  
 ⇒ 08/15

12-37256-01  
11 34 0 035 853  
 06/15→

70-36866-00 ES 8x

70-37256-00 AS 8x

71-11403-00 4x  
11 61 7 633 493

71-11394-00   
11 62 7 617 523

70-31414-10

81-37002-00 K  
11 11 8 604 931  
55x68  
AB RD PTFE

81-10448-00 K  
11 14 8 602 594  
90x104  
LD PTFE ACM

2,0 B48 A20 B 170 kW (231 PS) CLUBMAN JOHN COOPER WORKS (F54) COUNTRYMAN JOHN COOPER WORKS ALL4 (F60) JCW CABRIOLET (F57) 05/15

61-10076-00  
11 12 8 654 272  
82 Ø  
0,7 mm  
MLS

61-10076-10  
11 12 8 654 273  
82 Ø  
1 mm  
MLS

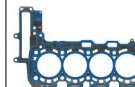

14-12261-02

71-11411-00  
11 12 8 618 519

12-36866-03  
11 34 0 038 719

12-37256-01  
11 34 0 035 853

71-11403-00 4x  
11 61 7 633 493

71-11394-00   
11 62 7 617 523

70-31414-10

81-37002-00 K  
11 11 8 604 931  
55x68  
AB RD PTFE

81-10448-00 K  
11 14 8 602 594  
90x104  
LD PTFE ACM

2,0 B48 A20 E 225 kW (306 PS) CLUBMAN JCW (R54) COUNTRYMAN JOHN COOPER WORKS ALL4 (F60) 07/19 [NEW]



08-11346-01

61-10166-00  
83 Ø  
0,8 mm  
MLS

61-10166-10  
83 Ø  
1,1 mm  
MLS

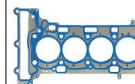

14-12261-02

71-17437-00

12-36866-03  
11 34 0 038 719

12-37256-03  
11 34 0 038 720

















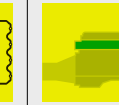
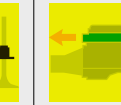
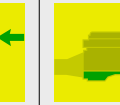



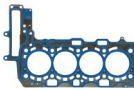















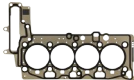
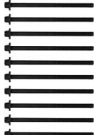





71-11403-00 4x  
11 61 7 633 493

71-17430-00

70-31414-10

81-37002-00 K  
11 11 8 604 931  
55x68  
AB RD PTFE

81-10448-00 K  
11 14 8 602 594  
90x104  
LD PTFE ACM

MINI														
2,0	B48 A20 F	120-155 kW (163-211 PS)	 1		02-11411-02 			61-10076-00 11 12 8 654 272 82 Ø 0,7 mm MLS  61-10076-10 11 12 8 654 273 82 Ø 1 mm MLS 	14-12261-02 	71-11411-00 11 12 8 618 519 	12-36866-03 11 34 0 038 719 	71-11403-00  4x 11 61 7 633 493   71-11394-00  11 62 7 617 523 	70-31414-10 	81-37002-00  11 11 8 604 931 55x68 AB RD PTFE   81-10448-00  11 14 8 602 594 90x104 LD PTFE ACM 
2,0	N47 C20 A	82-105 kW (112-143 PS)	CABRIOLET COOPER D (R57) CABRIOLET COOPER SD (R57) CLUBMAN COOPER D (R55) CLUBMAN COOPER SD (R55) CLUBVAN COOPER D (R55) COOPER D (R56) COOPER SD (R56) COUNTRYMAN COOPER D ALL4 (R60) COUNTRYMAN COOPER D (R60) COUNTRYMAN COOPER SD ALL4 (R60) COUNTRYMAN COOPER SD (R60) COUPE COOPER SD (R58) PACEMAN COOPER D ALL4 (R61) PACEMAN COOPER D (R61) PACEMAN COOPER SD ALL4 (R61) PACEMAN COOPER SD (R61) ROADSTER COOPER SD (R59) 06/09-10/16					61-38110-00 11 12 8 509 146 84,7 Ø 1,45 mm MLS   61-38110-10 11 12 8 509 147 84,7 Ø 1,55 mm MLS   61-38110-20 11 12 8 509 148 84,7 Ø 1,65 mm MLS  	14-10398-01 11 12 8 513 128 	15-41286-01 11 12 8 511 814 	12-39398-01 11 34 7 807 347   70-39398-00 16x 	71-10395-00  4x 11 61 8 507 332   71-39421-10  2x 11 62 8 509 783  02/13   71-39444-00   11 65 7 800 596 	70-31414-10 	81-39382-00  11 11 7 802 665 55x68 RD FPM   81-39379-00  11 14 7 797 490 90x104 LD FPM 

# Haftungsausschluss

## (für Katalog)

**Alle Angaben in unserem Katalog** wurden von uns sorgfältig geprüft, sind jedoch unverbindlich. Ersatzansprüche wegen Katalogangaben werden von uns nicht anerkannt. Der Käufer ist selbst verpflichtet, zu prüfen, ob unsere Teile für seine Zwecke geeignet sind. In allen Zweifelsfällen sollte Rücksprache mit unserem technischen Kundendienst erfolgen **Tel. +49 731 7046 999**.

**Technische Weiterentwicklungen** oder Änderungen bleiben vorbehalten, soweit damit keine Nachteile für den Kunden verbunden sind.

**Angaben, Namens- und Markenzeichen**, Beschreibungen, Nummern von Fahrzeugnummern und Herstellerzeichen, Original-Ersatzteilnummern der Fahrzeug- und Motorenhersteller u. a. sind ausschließlich für interne Zwecke gedacht. Solche Kennzeichnungen dürfen Fahrzeugbesitzern gegenüber nicht verwendet werden.

**Wir weisen ausdrücklich darauf hin**, dass alle von uns gelieferten Teile von geschultem Fachpersonal einzubauen sind. Reinz haftet für Fehler in diesem Katalog nur, wenn diese für den Kunden nicht offenbar erkennbar sind sowie nur bei Vorsatz und grober Fahrlässigkeit von Reinz, eines Vertreters oder eines Erfüllungsgehilfen. Dieser Haftungsausschluss gilt nicht im Rahmen

des Anwendungsbereichs des Produkthaftungsgesetzes und nicht bei Verletzung von Körper, Leben und Gesundheit, sowie bei der Verletzung von sog. Kardinalpflichten. Darüber hinaus ist unsere Haftung für Schäden, insbesondere für Personen-, Sach- oder Vermögensschäden, die unmittelbar oder mittelbar im Zusammenhang mit der Nutzung dieses Kataloges auftreten, sowie für nicht voraussehbare Schäden ausgeschlossen.

**Reinz ist Inhaber aller Schutzrechte** an den in diesem Katalog gespeicherten Daten. Kopie, Nachdruck, ganze oder teilweise Übernahme der Inhalte und Vervielfältigung, auch auszugsweise, ist nur mit unserer vorheriger schriftlicher Zustimmung sowie mit unserem Urheberrechtsvermerk zulässig.

Für Bestellungen, welche ab dem Erscheinungsdatum eines neuen Katalogs getätigt werden, sind alleine die Angaben des neuen Katalogs maßgeblich. Auf Angaben im Vorkatalog kann bei Neubestellungen nicht mehr zurückgegriffen werden.

**Sofern Sie noch Fragen haben, bitten wir Sie, sich mit uns in Verbindung zu setzen.**

[VictorReinz.com/AGB](http://VictorReinz.com/AGB)

# Exclusion of Liability

## (for catalog)

**All details in our catalog** have been thoroughly checked by us but are however not binding. Right to damages on account of catalog details will not be recognized. The purchaser is obliged to check if our parts are suitable for their use. In all doubtful cases, the purchaser should consult our technical customer service under **+49 731 7046 999**.

**We reserve the right** to further technical developments or changes as long as no disadvantage for the customer results.

**Details, name and trademarks**, descriptions, numbers from vehicle numbers and manufacturer symbols, original vehicle replacement part numbers and engine manufacturer etc. are solely for internal use. Such labels must not be used with vehicle owners.

**We specifically point out** that all parts supplied by us must be assembled by trained specialists.

**Reinz is liable for mistakes** in this catalog only when they are not clearly recognizable for the customer, as well as by intent or gross negligence on the part of Reinz, its representative or vicarious agent. This exclusion of liability does not apply within the framework of the field of

application of the product liability laws and not by bodily harm, life and health, as well as by violation of cardinal duties. In addition, our liability for damages, especially personal, property or financial damages that occur directly or indirectly as a result of the use of this catalog, as well as non-foreseeable damages are excluded.

**Reinz is the owner of all patent rights** on the data stored in this catalog. Copies, reprints, whole or partial takeover of the contents and duplication even in excerpts are only permissible with our prior written approval, as well as with our copyright note.

**For orders placed after the publication date** of a new catalog, only the details in the new catalog are binding and no fall back to details in the previous catalog is possible.

**In case you have further questions, do not hesitate to contact us.**

[VictorReinz.com/AGB](http://VictorReinz.com/AGB)



**VictorReinz.com**

**reinz.info@dana.com**

**Technical Hotline +49 (0)731 7046-9 99**

**REINZ-Dichtungs-GmbH**

Reinzstrasse 3-7  
89233 Neu-Ulm  
Germany  
+49 (0)731 7046-0

***VICTOR REINZ***<sup>®</sup>

---

