

VICTOR REINZ®

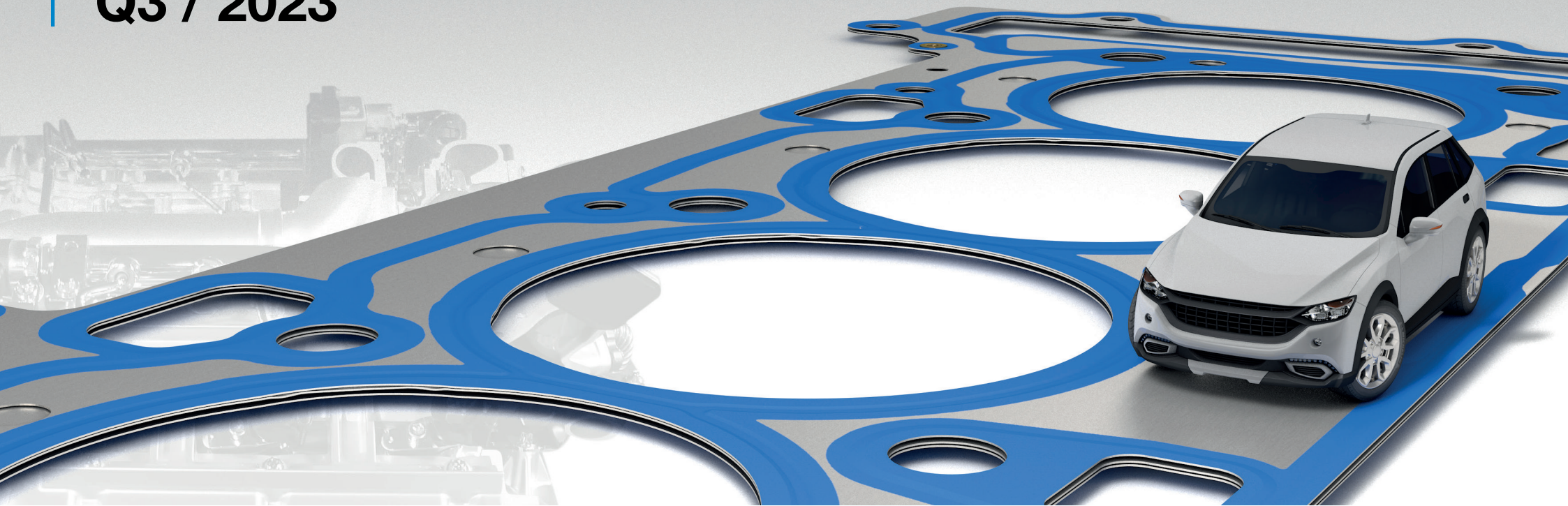

**OPEL/VAUXHALL
Q3 / 2023**



VictorReinz.com/online-catalog

Victor Reinz®

at a Glance



Online Catalog

VictorReinz.com/online-catalog



Newsletter

VictorReinz.com/EN/News/Newsletter.aspx?region



Youtube

www.youtube.com/user/VictorReinzSealingEN



Catalog News

VictorReinz.com/news



Technical Service Information

VictorReinz.com/tsi



Facebook

www.facebook.com/VictorReinzParts



Just seal it!

VictorReinz.com/jsi



Technical Datasheet

VictorReinz.com/jsi-datasheet



LinkedIn

www.linkedin.com/showcase/victor-reinz-emea



Safety Datasheet

VictorReinz.com/jsi-datasheet



Homepage

VictorReinz.com

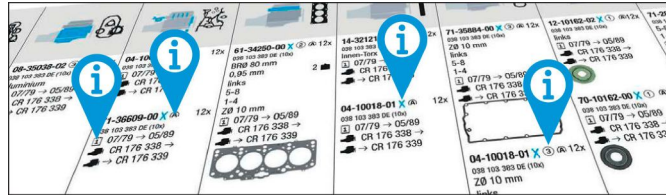

[VictorReinz.com/catalog-info](https://www.victorreinz.com/catalog-info)

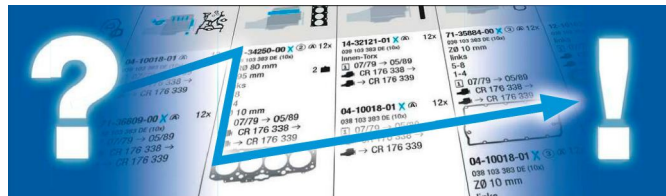

[VictorReinz.com/catalog-how-to-use](https://www.victorreinz.com/catalog-how-to-use)

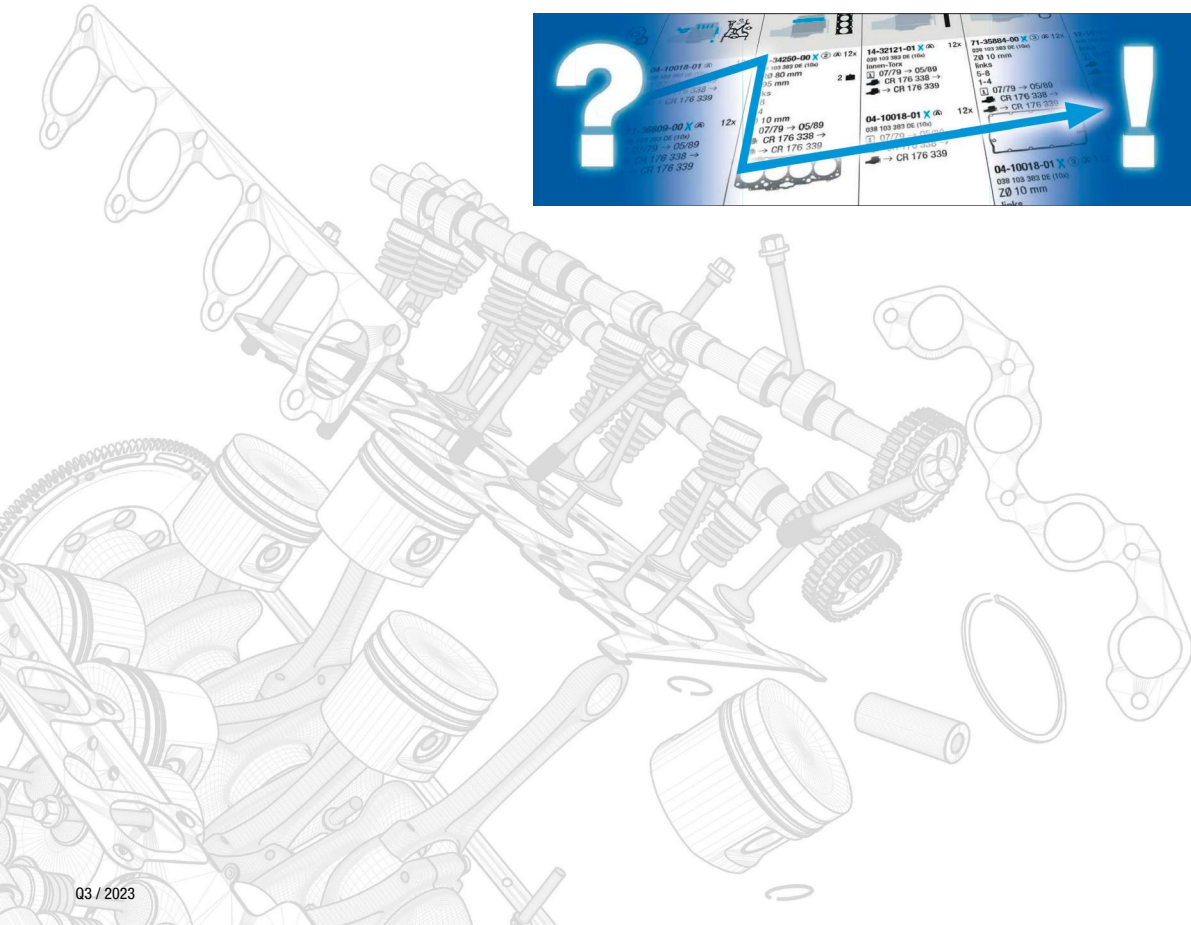

OPEL/VAUXHALL



0-9	
10 HM	173
10 N	8
10 S	9
12 N	16
12 NC	12
12 NV	17
12 NZ	11
12 S	17
12 SC	18
12 ST	17
13 N	18, 21
13 NB	21
13 S	22
13 SB	22
14 NV	33
14 SE	34
15 D	40
15 DT	40
15 DT (T4EC1)	40
15 TD	41
16 D	65-69
16 DA	69-71
16 LZ2	72
16 N	72
16 N (CH)	72
16 NZR	52
16 S	73
16 SH	72
16 SV	50, 73
17 D	77, 82
17 D (4EE1)	77
17 DR	82
17 DT	77
17 DT (TC4EE1)	77
17 N	83
17 S	84-85
17 TD	77
18 E	99
18 N	99
18 NV	86
18 S	99
18 SE	99
18 SEH	100
18 SV	86



19 DJ	101
19 DL	101
19 E	105
19 N	105
19 S	106
19 SH	107
20 D	130
20 E	117
20 EH	117
20 N	130
20 NE	112
20 NEJ	131
20 S	131
20 SE	112, 132
20 SEH	112
20 XE	114
20 XEJ	114
21 D	133
22 E	140
23 D	143
23 DTR	144
23 TD	140, 144
23 YD	144
23 YDT	140, 144
25 DG	149
25 DM	149
25 DT	157
25 E	157
25 H	157
25 NE	147
25 S	157
25 TDS	158
25TD	158
25TDS (VM41B)	158
28 E	163
28 EC	163
28 H	163
28 HC	163
28 HL	164
28 S	164
28 TDI	164
28 TDI (4JB1-T)	164
28TD	164
30 E	165, 170
30 H	171



30 NE	166
4 JA1	158
4 JG2TC	172
4 JX1	171
4HB (DW12RUD)	140
4HH (DW12RUC)	140
4HK (DW12RUE)	140
4JA1	158
4JA1-TC	159
4ZC1	133
6 VD1	174
6 VE1	174
6VD1 (DOHC)	174
A	
A 10 XEP	6
A 12 XEL	9
A 12 XER	9
A 13 DTC	18
A 13 DTE	18
A 13 DTR	18
A 13 FD	18
A 14 FC	22
A 14 FP	23
A 14 NEL	23-24
A 14 NET	23-26
A 14 XEL	26-27
A 14 XER	26-28
A 14 XFL	28
A 16 DT (DV6D)	41
A 16 DTH	42
A 16 FDH	42
A 16 FDL	42
A 16 LEL	43
A 16 LER	43
A 16 LES	43
A 16 LET	43
A 16 NHT (EP6FDT)	43
A 16 NHT (EP6FDTM)	43
A 16 SHT	43
A 16 XER	44
A 16 XHL (EP6FDTMD)	44
A 16 XHT	43
A 16 XNT	43
A 17 DT	73-74



A 17 DTC	74
A 17 DTE	74
A 17 DTF	74
A 17 DTI	74
A 17 DTJ	73, 75-76
A 17 DTL	73-74
A 17 DTN	74
A 17 DTR	73-76
A 17 DTS	74
A 18 XEL	85
A 18 XER	85
A 20 DT	107
A 20 DTC	108
A 20 DTE	107
A 20 DTH	107-108
A 20 DTJ	108
A 20 DTL	107
A 20 DTR	107
A 20 FD	108
A 20 NFT	109
A 20 NHT	110
A 22 DM	133
A 22 DMH	133
A 24 XE	144
A 24 XF	145
A 28 NER	161
A 28 NET	161
A 30 XF	165
A 30 XH	166
B	
B 10 XE	6
B 10 XFL	6
B 10 XFT	6
B 10 XL	6
B 12 XE (EB2F)	10
B 12 XEL	9-10
B 12 XER	10
B 12 XHL	10
B 12 XHL (EB2DT)	10
B 12 XHT (EB2DTS)	10
B 13 DTC	19
B 13 DTE	19
B 13 DTN	19
B 13 DTR	19



B 14 NEH	28
B 14 NEJ	29
B 14 NEL	23-24, 29
B 14 NET	23-26, 29-30
B 14 XE	30
B 14 XEJ	31
B 14 XEL	31
B 14 XER	31-32
B 14 XFL	32
B 14 XFT	32
B 14 XNT	32
B 15 SFL	38
B 15 SFT	38
B 15 XFL	38
B 15 XFT	38
B 15 XHL	38
B 15 XHT	38
B 16 DT (DV6DTED)	41
B 16 DT (DV6FD)	45
B 16 DTC	42
B 16 DTE	42
B 16 DTH	42, 45
B 16 DTH (DV6FC)	45
B 16 DTJ	42
B 16 DTL (DV6FE)	45
B 16 DTN	42
B 16 DTR	46
B 16 DTU	42, 46
B 16 LER	43
B 16 LES	43
B 16 SHL	43
B 16 SHT	43
B 16 XER	44
B 16 XNT	43
B 18 XER	85
B 20 DTH	111
B 20 DTJ	111
B 20 NFT	110-111
B 20 NHT	111
B 28 NER	161
C	
C 12 NZ	11
C 13 N	19



C 14 NZ	33
C 14 SE	34
C 14 SEL	34
C 16 LZ	46
C 16 LZ2	47
C 16 NZ	47
C 16 NZ2	47
C 16 SE	48
C 16 SEL	49
C 16 XE	49
C 18 NE	86
C 18 NT	86
C 18 NZ	86
C 18 SEL	87
C 18 XE	87
C 18 XEL	87
C 20 LET	112
C 20 NE	112-113
C 20 NEF	112
C 20 NEJ	112
C 20 SEL	113
C 20 XE	100, 114
C 22 SEL	134
C 223	134
C 24 NE	145
C 25 XE	146
C 26 NE	159
C 30 LE	166
C 30 NE	166
C 30 SE	166
C 30 SEJ	166
C223	134
D	
D 10 XE	6
D 10 XFL	6
D 10 XFT	7
D 12 XE (EB2FA)	11
D 12 XEL	11
D 12 XHL	12
D 12 XHL (EB2ADT)	12
D 12 XHT (EB2ADTS)	12
D 13 A	20
D 14 NEH	28
D 14 NEJ	35



D 14 NEL	29
D 14 NET	24, 30, 35
D 14 XEL	31
D 14 XER	27
D 14 XFL	32
D 14 XFT	32
D 15 DT (DV5RCF)	39
D 15 DT (DV5RD)	39
D 15 DT (DV5RUCD)	39
D 15 DTH (DV5RC)	39
D 15 DTH (DV5RUC)	39
D 15 DTL (DV5RE)	39
D 15 DVC	40
D 15 DVH	40
D 15 SFL	38
D 15 SFT	38
D 15 XHT	38
D 16 DTE	42
D 16 DTH	42
D 16 DTI	42
D 16 DTJ	42
D 16 DTN	42
D 16 DTR	50
D 16 SHJ	43
D 16 SHL	43
D 16 SHT	43
D 16 XER	44
D 16 XHT (EP6FADTXD)	50
D 16 XHT (EP6FADTXHP)	50
D 20 DTH	111
D 20 DTH (DW10FC)	114
D 20 DTH (DW10FD)	115
D 20 DTJ	111
D 20 DTL (DW10FE)	115
D 20 DTR	115
D 20 DTR (DW10FDCU)	116
D 20 DVH	116
D 20 NFT	111
DGX (EP6FADTXHPE)	50
DGY (EP6FADTXHPD)	50
DGZ (EP6FADTXHP)	50
DW10FDDU340	115
DW10FDDU370	115

OPEL/VAUXHALL



E

E 12 GV	12
E 16 NZ	47
E 16 SE	50
E 18 NV	86
E 18 NVR	86
EB2ADT	12

F

F 10 XFL	6
F 12 SHL	12
F 12 SHR	12
F 12 SHT	12
F 12 XE (EB2FA)	11
F 12 XEL (EB2FAD)	11
F 12 XEL (EB2FD)	11
F 12 XHL (EB2ADT)	12
F 12 XHL (EB2ADTD)	12
F 12 XHT (EB2ADTS)	12
F 14 SHL	36
F 14 SHT	36
F 15 DT (DV5RCE)	39
F 15 DTH (DV5RC)	39
F 15 DVC	40
F 15 DVH	40
F 16 XHR (EP6FADTXD)	50
F 20 DVH	116
F10A	7
F20DVH	116
F20SHL	116
F20SHT	116
F4R 720	117
F4R 820	117
F8Q 600	101
F8Q 606	101
F9Q 760	101-102
F9Q 762	101-102
F9Q 770	102
F9Q 772	103
F9Q 774	101

G

G9T 720	135
G9T 722	135
G9T 750	135



G

G9U 630	146
G9U 632	146
G9U 650	146
G9U 720	147
G9U 724	146-147
G9U 730	146
G9U 750	146-147
G9U 754	147

H

H 20 E	117
H 25 E	147
HMU (EB2FAMD)	11
HNK (EB2ADTD)	12
HNL (EB2ADTSM)	12
HNP (EB2ADT)	12
HNS (EB2ADTS)	12
HNV (EB2DTM)	10
HNZ (EB2DT)	10

K

K 10 B	7
K 12 B	13
K10B	7
K12B	13

L

LNF	118
-----	-----

M

M9R 630	118
M9R 692	118
M9R 780	118
M9R 782	118
M9R 784	118
M9R 786	118
M9R 788	118
M9T 670	141
M9T 672	141
M9T 676	141
M9T 678	141
M9T 680	141
M9T 686	141
M9T 690	141
M9T 692	141



M

M9T 694	141
M9T 696	141
M9T 698	141
M9T 700	141
M9T 702	141-142
M9T 704	142
M9T 706	143
M9T 708	142
M9T 710	143
M9T 716	143
M9T 870	141
M9T 876	141
M9T 878	141
M9T 880	141
M9T 890	141
M9T 892	141
M9T 896	141
M9T 898	141

R

R9M 408	51
R9M 413	51
R9M 415	51
R9M 450	51
R9M 452	51

S

S 18 NV	86
S8U 758	148
S8U 770	148
S8U 772	149
S8U 780	149
S8U 782	149
S9W 700	162
S9W 702	162

U

U 25 DT	150
U 25 TD	150

X

X 10 XE	8
X 12 SZ	11
X 12 XE	13
X 14 NZ	33



X

X 14 SZ	33
X 14 XE	34, 36
X 15 D	40
X 15 DT	40
X 15 DT (T4EC1)	40
X 15 TD	40
X 16 SZ	52
X 16 SZR	52
X 16 XE	53
X 16 XEL	53-55
X 17 D	77
X 17 D (4EE1)	77
X 17 DT	77
X 17 DT (TC4EE1)	77
X 17 DTL	78
X 17 TD	77
X 18 XE	88
X 18 XE1	89-92
X 20 DTH	118
X 20 DTL	118
X 20 SE	119-120
X 20 XER	120
X 20 XEV	121-126
X 22 DTH	136
X 22 SE	136
X 22 XE	137
X 25 DT	150
X 25 TD	150
X 25 XE	150-156
X 30 XE	167
X17TD	77

Y

Y 13 DT	20
Y 16 XE	55-56
Y 16 YNG	56
Y 17 DT	78-79
Y 17 DTL	78
Y 20 DTH	126-127
Y 20 DTJ	108
Y 20 DTL	128
Y 22 DTH	136-138
Y 22 DTR	137-138
Y 22 SE	136
Y 22 XE	139



Y

Y 25 DT	156
Y 26 SE	159-161
Y 30 DT	168
Y 32 SE	172
YHY (DV5RCF)	39
YHZ (DV5RC)	39

Z

Z 10 XE	8
Z 10 XEP	8
Z 12 XE	13-15
Z 12 XEP	15-16
Z 13 DT	20
Z 13 DTE	18
Z 13 DTH	20
Z 13 DTI	18
Z 13 DTJ	20
Z 13 DTR	18
Z 14 XE	37
Z 14 XEL	37
Z 14 XEP	37
Z 16 LEL	43
Z 16 LER	43
Z 16 LET	43
Z 16 SE	57
Z 16 XE	58-60
Z 16 XE1	62-63
Z 16 XEP	61
Z 16 XER	44, 61
Z 16 XNT	43
Z 16 XU (EC5F)	64
Z 16 YNG	56, 64
Z 17 DT	74
Z 17 DTH	79-80
Z 17 DTJ	73-74, 76, 80-81
Z 17 DTL	81-82
Z 17 DTR	74
Z 18 XE	92-96
Z 18 XEL	97-98
Z 18 XER	85, 98
Z 19 DT	103-104
Z 19 DTH	105
Z 19 DTJ	105
Z 19 DTL	103
Z 20 DM	128

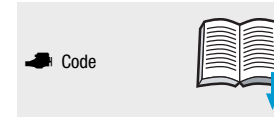

Z

Z 20 DMH	128
Z 20 DTJ	108
Z 20 LEH	129
Z 20 LEL	129
Z 20 LER	129
Z 20 LET	129
Z 20 NET	129
Z 20 NHH	118
Z 20 S	128
Z 22 SE	139
Z 22 XE	139
Z 22 YH	139
Z 24 SED	145
Z 24 XE	145
Z 24 XED	145
Z 28 NEL	163
Z 28 NET	163
Z 30 DT	168
Z 32 SE	173
Z 32 SEE	173
ZD3 200	169
ZD3 202	169

OPEL/VAUXHALL														
1,0 A 10 XEP	44-48 kW (60-65 PS)	CORSA D CORSA III	08/06-08/14											
Ltr.					02-37890-01 16 06 423	08-40844-01 16 06 425	71-33492-00 638 133	61-37890-00 607 163 74 Ø MLS	14-32132-01 56 07 937 (10x)	71-34818-00 607 499	12-34223-01 642 500 (12x)	71-40686-00 850 092	71-40677-00 849 089	81-33489-10 20 91 167 42x55 RD FPM
														81-24908-10 614 203 80x98 A SL LD FPM
											70-34223-00 642 500			
1,0 B 10 XE B 10 XL D 10 XE	54-55 kW (73-75 PS)	KARL KARL LPG VIVA VIVA LPG	01/15-03/19											
					02-10135-02	08-10135-02		61-10135-00 12 637 389 75 Ø 0,86 mm MLS	14-10014-01 11 548 125 (8x)	15-10044-01 55 599 336	12-11645-01 12 661 724 (6x)	71-12161-00 55 583 673	71-12174-00 55 581 001	81-10458-00 12 661 527 44x60 A SL FPM
														81-10457-00 12 653 685 84x100 A SL LD FPM
														81-10459-00 12 638 690 37x54 FPM
1,0 B 10 XFL B 10 XFT D 10 XFL F 10 XFL	66-85 kW (90-116 PS)	ADAM ASTRA K ASTRA K Turbo ASTRA VII CORSA E CORSA IV	07/14											
					02-10135-01	08-10135-01	04-10354-01	61-10135-00 12 637 389 75 Ø 0,86 mm MLS	14-11653-01 11 611 069 (8x)	15-11533-01	12-11645-01 12 661 724 (6x)	71-11561-00 55 595 142	71-12268-00 55 578 959	81-10458-00 12 661 527 44x60 A SL FPM
														81-10457-00 12 653 685 84x100 A SL LD FPM
														81-10459-00 12 638 690 37x54 FPM

OPEL/VAUXHALL														
Ltr.														
1,0 D 10 XFT	85 kW (115-116 PS) ADAM CORSA E CORSA IV	07/14												
					02-10135-01 12 637 389 75 Ø 0,86 mm MLS	08-10135-01		61-10135-00 12 637 389 75 Ø 0,86 mm MLS	14-11653-01 11 611 069 (8X)	15-11533-01	12-11645-01 12 661 724 (6X)	71-11561-00 55 595 142 71-12268-00 55 578 959 	70-31414-10 	81-10458-00 12 661 527 44x60 A SL FPM 81-10457-00 12 653 685 84x100 A SL LD FPM 81-10459-00 N 12 638 690 37x54 FPM
1,0 F10A	34 kW (46 PS) RASCAL	07/86-08/93					61-52330-10 67 Ø		71-52329-00	12-52957-02	71-52326-00 2x 	71-52324-00 	71-52548-00 	81-53237-00 32x47 A SL RD NBR 81-53297-00 60x80 A SL LD MVQ 81-53237-00 N 32x47 A SL RD NBR
1,0 K 10 B K10B	48-50 kW (65-68 PS) AGILA AGILA II	01/08-11/14			02-37655-01 47 09 983 +47 08 944 (12x) +47 08 889 (4x)		61-37655-00 47 08 883 MLS	14-32307-01 47 09 233 (8x)	71-39373-00 47 08 887	12-39357-01 47 08 944 (12x)	71-39341-00 47 09 045 	71-39362-00 47 09 948 	70-31414-10 	81-53699-00 47 09 000 41x53 A SL RD FPM 81-39377-00 47 08 962 83x97 A SL LD FPM

OPEL/VAUXHALL														
Ltr.														
1,0 X 10 XE	40 kW (54 PS) CORSA CORSA B	11/96-09/00		02-33495-01 16 06 463 +642 533 (16x) 	08-33491-01 16 06 464 	71-33492-00 638 133 	61-33495-00 56 07 058 72,5 Ø 0,55 mm MLS 61-33495-10 72,5 Ø 0,8 mm MLS 	14-32132-01 56 07 937 (10x) 	71-33508-00 607 749 	12-34223-01 642 500 (12x) 70-34223-00 642 500 12x 	71-33507-00 58 50 858 71-33509-00 850 672 	71-33491-00 652 647 	81-33489-10 20 91 167 42x55 RD FPM 81-24908-10 614 203 80x98 A SL LD FPM 	
1,0 Z 10 XE	43 kW (58 PS) AGILA CORSA C CORSA II	09/00-12/07		02-33495-02 16 06 167 	08-33491-01 16 06 464 	71-33492-00 638 133 	61-33495-00 56 07 058 72,5 Ø 0,55 mm MLS 61-33495-10 72,5 Ø 0,8 mm MLS 	14-32132-01 56 07 937 (10x) 	71-34818-00 607 499 	12-34223-01 642 500 (12x) 70-34223-00 642 500 12x 	71-34266-00 849 515 71-33509-00 850 672 	71-33491-00 652 647 	81-33489-10 20 91 167 42x55 RD FPM 81-24908-10 614 203 80x98 A SL LD FPM 	
1,0 Z 10 XEP	44 kW (60 PS) AGILA CORSA C CORSA D CORSA II CORSA III	02/00-08/14		02-37250-01 16 06 246 	08-33491-02 16 06 249 	71-33492-00 638 133 	61-37250-00 56 07 838 0,32 mm MLS 61-37250-10 0,57 mm MLS 	14-32132-01 56 07 937 (10x) 	71-34818-00 607 499 	12-34223-01 642 500 (12x) 70-34223-00 642 500 12x 	71-36203-00 58 50 796 71-33509-00 850 672 	71-33491-00 652 647 	81-33489-10 20 91 167 42x55 RD FPM 81-24908-10 614 203 80x98 A SL LD FPM 	
1,0 10 N	29 kW (39-40 PS) KADETT A KADETT C	09/62-07/79		02-19654-06 16 06 377 +642 519 (4x) 	08-12803-02 16 06 668 	61-19654-30 607 465 73,5 Ø 1,4 mm 		71-12955-00 607 670 	12-25184-01 642 519 (4x) 70-25184-00 642 519 4x 	71-20634-20 850 618 71-19848-20 850 610 	10-12803-02 16 06 228 	81-21343-00 614 818 54x82 A LD ACM 		

OPEL/VAUXHALL														
Ltr.														
1,0 10 S	33-37 kW (45-50 PS) CORSA A KADETT A KADETT C KADETT D NOVA NOVAVAN	09/62-03/93			02-19654-05 16 06 685 +642 519 (4x) 	08-12803-02 16 06 668 		61-19654-60 607 445 +638 182 73,5 Ø 0,75 mm 	14-32035-01 607 233 (5x) +607 234 (5x) 	71-12955-00 607 670 	12-25184-01 642 519 (4x) 	71-20634-20 850 618 71-19848-20 850 610 71-26198-10 854 945 	10-12803-02 16 06 228 	81-21343-00 614 818 54x82 A LD ACM
1,2 A 12 XEL B 12 XEL	51 kW (69 PS) ADAM	10/12-04/19		01-37875-02 	02-37875-04 	08-10027-01 16 06 326 	71-40668-00 638 130 	61-37875-00 607 161 74 Ø MLS 	14-32331-01 607 165 (12x) 	71-17813-00 25 198 753 	12-34223-02 642 500 (16x) 	71-40686-00 850 092 71-40694-00 860 155 71-36304-00 849 541 	70-31414-10 	81-33489-10 20 91 167 42x55 RD FPM 81-24908-10 614 203 80x98 A SL LD FPM
1,2 A 12 XEL A 12 XER	51-63 kW (69-86 PS) CORSA D CORSA III CORSA III LPG CORSAVAN III	12/09		01-37875-02 	02-37875-04 			61-37875-00 607 161 74 Ø MLS 	14-32331-01 607 165 (12x) 	71-40674-00 642 026 → 19EN7802 71-17813-00 25 198 753 → 19EN7803 → 	12-34223-02 642 500 (16x) 	71-40686-00 850 092 71-40694-00 860 155 71-36304-00 849 541 	70-31414-10 	81-33489-10 20 91 167 42x55 RD FPM 81-24908-10 614 203 80x98 A SL LD FPM

OPEL/VAUXHALL													
Ltr.													
1.2 B 12 XE (EB2F)	60-61 kW (82-83 PS)	CROSSLAND CROSSLAND LPG	03/17										
				02-37745-01 	08-10461-01 		61-37745-00 36 39 558 76,3 Ø 0,7 mm MLS 	14-10026-01 36 47 147 	15-11549-01 36 45 971 	12-12155-01 35 53 388 70-12155-00 	11-11551-01 36 45 962 71-11552-00 36 39 476 	70-31414-10 	81-41219-00 36 39 588 61x75 A SL RD PTFE (Polytetrafluorethylen)/ACM (Polyacryl-Kautschuk) 81-10461-00 36 47 152
1.2 B 12 XEL B 12 XER	51 kW (69 PS)	CORSA E CORSA IV CORSAVAN IV	08/14				61-37875-00 607 161 74 Ø MLS 		71-17813-00 25 198 753 	12-34223-02 642 500 (16x) 70-34223-00 642 500 	71-40686-00 850 092 71-36304-00 849 541 		81-33489-10 20 91 167 42x55 RD FPM 81-24908-10 614 203 80x98 A SL LD FPM
1.2 B 12 XHL B 12 XHL (EB2DT) B 12 XHT (EB2DTS) HNW (EB2DTM) HNZ (EB2DT)	81-96 kW (110-131 PS)	CROSSLAND GRANDLAND GRANDLAND Turbo	03/17				61-10179-00 3639918 76 Ø 0,75 mm MLS 	14-10026-01 36 47 147 	71-12157-00 36 39 885 	12-12155-01 35 53 388 70-12155-00 	71-12156-00 36 39 873 71-13234-00 36 39 848 	70-31414-10 	81-41219-00 36 39 588 61x75 A SL RD PTFE (Polytetrafluorethylen)/ACM (Polyacryl-Kautschuk) 81-10461-00 36 47 152

OPEL/VAUXHALL														
1.2	C 12 NZ X 12 SZ 12 NZ	33 kW (45 PS)	COMBO CORSA CORSA A CORSA B NOVA	09/89-12/01		02-29270-01 16 06 701 +642 527 (8x) → 19718215	08-12996-05 16 06 728 	61-29270-00 607 998 1,3 mm 	14-32102-01 607 242 (10x) 	71-13043-00 638 727 → 19718215 	12-26546-01 642 527 (8x) 70-26546-00 642 527 	71-28182-10 850 522 71-24602-30 850 615 	71-12996-10 652 611 	81-27295-00 646 274 26x42 AB SL RD FPM 81-24908-10 614 203 80x98 A SL LD FPM 81-24909-10 56 36 970 35x48 A SL RD MVQ
1.2	D 12 XE (EB2FA) F 12 XE (EB2FA) F 12 XEL (EB2FAD) F 12 XEL (EB2FD) HMU (EB2FAMD)	55-61 kW (75-83 PS)	CORSA F CORSA V CROSSLAND	03/17	02-10002-04	08-10155-01 	61-10002-00 35 53 550 76,3 Ø 0,7 mm MLS	14-10026-01 36 47 147 	15-11183-01 35 53 598 	12-12155-01 35 53 388 	11-11551-10 36 45 962 71-11552-00 36 39 476 	70-31414-10 	81-41219-00 36 39 588 61x75 A SL RD PTFE (Polytetrafluorethylen)/ACM (Polyacryl-Kautschuk) 81-10461-00 36 47 152 	
1.2	D 12 XEL	51 kW (69 PS)	ADAM	10/12-04/19	01-37875-02 	02-37875-04 	71-40668-00 638 130 	61-37875-00 607 161 74 Ø MLS 	14-32331-01 607 165 (12x) 	71-17813-00 25 198 753 71-40674-00 642 026 	12-34223-02 642 500 (16x) 70-34223-00 642 500 	71-40686-00 850 092 71-40694-00 860 155 71-36304-00 849 541 	70-31414-10 	81-33489-10 20 91 167 42x55 RD FPM 81-24908-10 614 203 80x98 A SL LD FPM

OPEL/VAUXHALL													
1.2	D 12 XHL D 12 XHL (EB2ADT) D 12 XHT (EB2ADTS) EB2ADT F 12 XHL (EB2ADT) F 12 XHL (EB2ADTD) F 12 XHT (EB2ADTS) HNK (EB2ADTD) HNL (EB2ADTSM) HNP (EB2ADT) HNS (EB2ADTS)	74-96 kW (101-131 PS)	ASTRA ASTRA L COMBO CORSA F CORSA V CROSSLAND GRANDLAND GRANDLAND Turbo MOKKA	03/17									
Ltr.													
02-10813-02	08-10157-01	61-10813-00 76 Ø MLS	14-10026-01 36 47 147	70-31414-10 U 71-18240-00 O	12-12155-01 35 53 388 70-12155-00 12x	71-12156-00 I 36 39 873 71-18242-00	70-31414-10	81-41219-00 K 36 39 588 61x75 A SL RD PTFE (Polytetrafluorethylen)/ACM (Polyacryl-Kautschuk) 81-10461-00 K 36 47 152					
1.2	E 12 GV 12 NC	33 kW (45 PS)	CORSA A	09/82-08/90									
02-22930-09 16 06 675 +642 530 (8x)	08-12803-02 16 06 668	61-22930-40 607 985 80 Ø 1,3 mm	14-32035-01 607 233 (5x) +607 234 (5x)	71-12955-00 607 670	12-27431-01 642 530 (8x) 70-27431-00 642 530	71-20634-20 I 850 618 71-19848-20 850 610 71-26198-10 854 945	10-12803-02 16 06 228	81-21343-00 K 614 818 54x82 A LD ACM					
1.2	F 12 SHL F 12 SHR F 12 SHT	81-107 kW (110-145 PS)	ASTRA K ASTRA VII Turbo	08/19									
02-10822-02	08-10158-01	61-10822-00 25 194 171 76 Ø MLS	14-18377-01 55 487 413 (8X)	71-18378-00 55 487 546	12-18379-01 55 489 460 (6X) 70-18379-00 55 496 009 70-18380-00 55 489 460	11-18382-01 I 55 486 276 6x 71-18383-00 55 506 629 6x	70-31414-10	81-10606-00 K 55 487 381 46 Ø 81-10607-00 K 55 487 411 85 Ø					

OPEL/VAUXHALL

Ltr.	K12 B K12B	63-69 kW (86-94 PS)	AGILA	01/08-11/14 [NEW]																	
1.2	K12 B K12B	63-69 kW (86-94 PS)	AGILA	01/08-11/14 [NEW]																	
1.2	X12 XE	48 kW (65 PS)	ASTRA G CORSA CORSA B	02/98-09/00																	
1.2	Z12 XE	55 kW (75 PS)	AGILA	09/00-03/08 1G001502																	

02-37660-01
47 09 984
+47 08 944 (16x)
+47 08 889 (4x)
 07/10

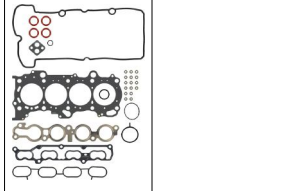

02-37660-02
95 508 502
 08/10→

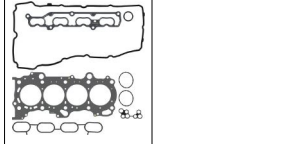

61-37660-00
47 11 148
MLS

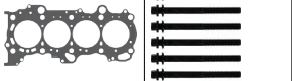

14-32307-02
47 09 233 (10x)

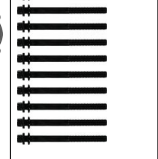

71-39372-00
47 08 888
 07/10

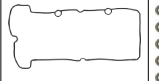

71-16980-00
47 11 581
 08/10→



12-39357-02
47 08 944 (16x)



70-39357-00
47 08 944



71-39347-00
47 09 958



71-39363-00
47 09 959



71-39348-00
47 09 029



70-31414-10



81-53689-00
47 09 000
41x53
A SL RD FPM



81-39377-00
47 08 962
83x97
A SL LD FPM



02-34162-01
16 06 365

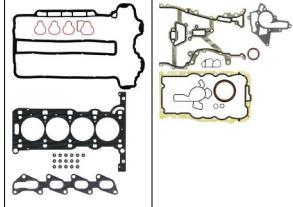

08-34166-01
16 06 596

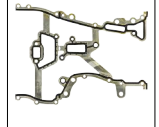

71-33492-00
638 133

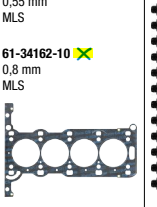

61-34162-00
56 07 448
0,55 mm
MLS

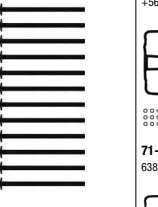

14-32132-02
56 07 937 (12x)

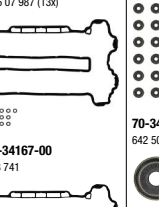

15-34167-01
638 741
+56 07 987 (13x)

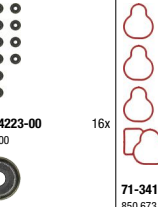

12-34223-02
642 500 (16x)

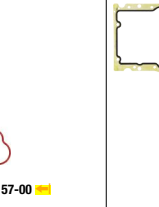

71-34156-00
849 999



81-33489-00
20 91 167
42x55
RD FPM



81-24908-10
614 203
80x98
A SL LD FPM



02-34162-02
16 06 094

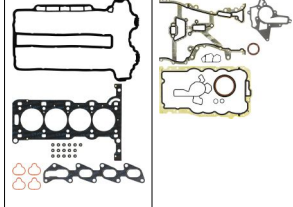

08-34166-01
16 06 596

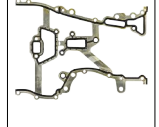

71-33492-00
638 133



14-32132-02
56 07 937 (12x)

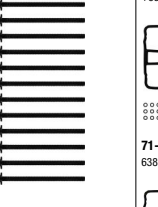

15-34167-01
638 741
+56 07 987 (13x)

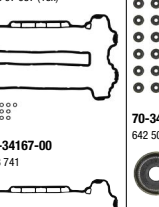

12-34223-02
642 500 (16x)

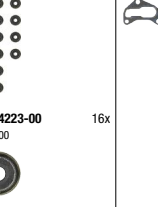

71-34157-00
850 673

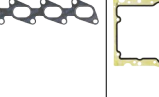

71-34166-00
652 616



81-33489-00
20 91 167
42x55
RD FPM



81-24908-10
614 203
80x98
A SL LD FPM



OPEL/VAUXHALL













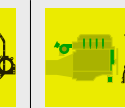

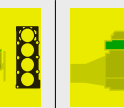

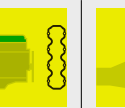
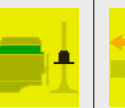
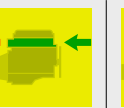
OPEL/VAUXHALL															
1.2 Z 12 XE	55 kW (75 PS)	AGILA	3G999999	09/00-03/08											
Ltr.					02-34162-03 16 06 169	08-34166-01 16 06 596	71-33492-00 638 133	61-34162-00 56 07 448 0,55 mm MLS 61-34162-10 0,8 mm MLS	14-32132-02 56 07 937 (12x)		12-34223-02 642 500 (16x)	71-34266-00 849 515 71-34157-00 850 673	4x 	71-34166-00 652 616	81-33489-10 20 91 167 42x55 RD FPM 81-24908-10 614 203 80x98 A SL LD FPM
1.2 Z 12 XE	55 kW (75 PS)	ASTRA G CORSA C CORSA II CORSAVAN II	32-38999999	09/00-12/09											
					02-34162-03 16 06 169	08-34166-01 16 06 596	71-33492-00 638 133	61-34162-00 56 07 448 0,55 mm MLS 61-34162-10 0,8 mm MLS	14-32132-02 56 07 937 (12x)	15-35888-01 56 07 467 +56 07 987 (13x)	12-34223-02 642 500 (16x)	71-34266-00 849 515 71-34157-00 850 673	4x 	71-34166-00 652 616	81-33489-10 20 91 167 42x55 RD FPM 81-24908-10 614 203 80x98 A SL LD FPM
1.2 Z 12 XE	55 kW (75 PS)	AGILA	1G001503→	09/00-03/08											
					02-34162-03 16 06 169	08-34166-01 16 06 596	71-33492-00 638 133		14-32132-02 56 07 937 (12x)	15-35888-01 56 07 467 +56 07 987 (13x)	12-34223-02 642 500 (16x)	71-34157-00 850 673	16x 	71-34166-00 652 616	81-33489-10 20 91 167 42x55 RD FPM 81-24908-10 614 203 80x98 A SL LD FPM

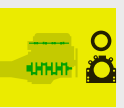
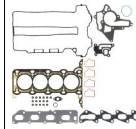
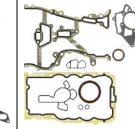
OPEL/VAUXHALL

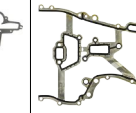
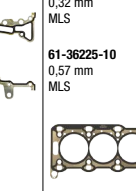
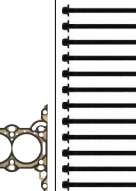
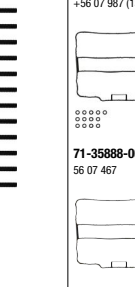
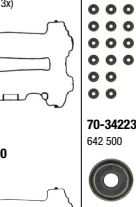

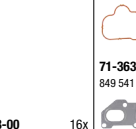
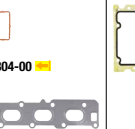







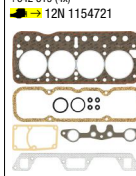

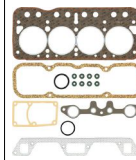

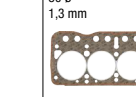
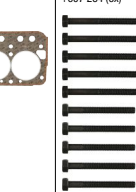
Ltr.	Engine	Power	Model	Part No.	Year	Image 1	Image 2	Image 3	Image 4	Image 5	Image 6	Image 7	Image 8	Image 9	Image 10	Image 11	Image 12
1,2	Z 12 XE	55 kW (75 PS)	AGILA	4G000001→	09/00-03/08												
							02-36225-01 16 06 247 	08-34166-01 16 06 596 	71-33492-00 638 133 	61-36225-00 56 07 837 0,32 mm MLS 61-36225-10 0,57 mm MLS 	14-32132-02 56 07 937 (12x) 		12-34223-02 642 500 (16x) 	71-36203-00 58 50 796 71-34157-00 850 673 	71-34166-00 652 616 	81-33489-10 20 91 167 42x55 RD FPM 81-24908-10 614 203 80x98 A SL LD FPM 	
1,2	Z 12 XE	55 kW (75 PS)	ASTRA G CORSA C CORSA II CORSAVAN II	42-4800001→ 42-4800001→ 42-4800001→ 42-4800001→	09/00-12/09												
							02-36225-01 16 06 247 	08-34166-01 16 06 596 	71-33492-00 638 133 	61-36225-00 56 07 837 0,32 mm MLS 61-36225-10 0,57 mm MLS 	14-32132-02 56 07 937 (12x) 	15-35888-01 56 07 467 +56 07 987 (13x) 	12-34223-02 642 500 (16x) 	71-36203-00 58 50 796 71-34157-00 850 673 	71-34166-00 652 616 	81-33489-10 20 91 167 42x55 RD FPM 81-24908-10 614 203 80x98 A SL LD FPM 	
1,2	Z 12 XEP	55-59 kW (75-80 PS)	AGILA CORSA C CORSA D CORSA D LPG CORSA III CORSA III LPG CORSAVAN II CORSAVAN IV		07/04												
							02-36225-01 16 06 247 	08-34166-01 16 06 596 	71-33492-00 638 133 	61-36225-00 56 07 837 0,32 mm MLS 61-36225-10 0,57 mm MLS 	14-32132-02 56 07 937 (12x) 	15-35888-01 56 07 467 +56 07 987 (13x) 	12-34223-02 642 500 (16x) 	71-36203-00 58 50 796 71-34157-00 850 673 	71-34166-00 652 616 	81-33489-10 20 91 167 42x55 RD FPM 81-24908-10 614 203 80x98 A SL LD FPM 	

OPEL/VAUXHALL

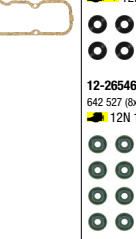



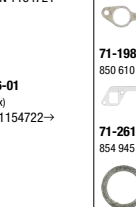

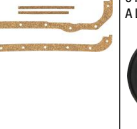















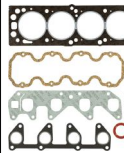
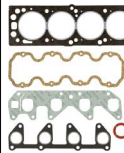

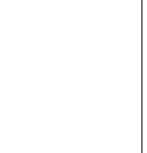
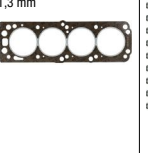
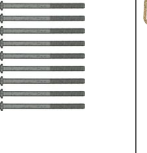
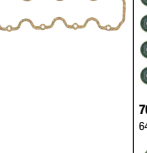
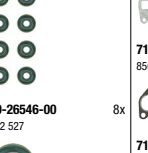

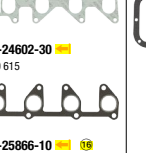

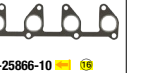
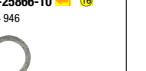



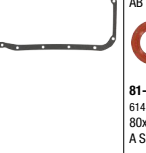





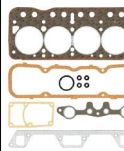

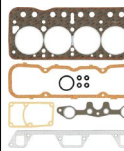

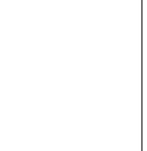
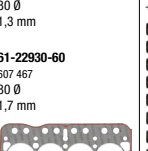
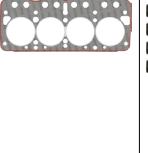
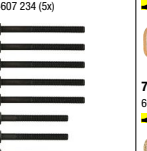
Ltr.  1.2 Z 12 XEP 59 kW (80 PS) ASTRA H  08/05-10/10  1

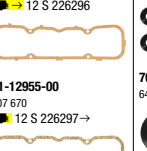
											
	<p>02-36225-01 16 06 247</p> 	<p>08-34166-01 16 06 596</p> 	<p>71-33492-00  638 133</p> 	<p>61-36225-00 56 07 837 0,32 mm MLS</p> <p>61-36225-10 0,57 mm MLS</p> 	<p>14-32132-02 56 07 937 (12x)</p> 	<p>15-35888-01 56 07 467 +56 07 987 (13x)</p> 	<p>12-34223-02 642 500 (16x)</p> <p>70-34223-00 642 500</p> 	<p>71-36203-00  4x 58 50 796</p> <p>71-36304-00  849 541</p> 	<p>71-34166-00 652 616</p> 	<p>81-33489-10  20 91 167 42x55 RD FPM</p> <p>81-24908-10  614 203 80x98 A SL LD FPM</p> 	

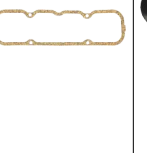
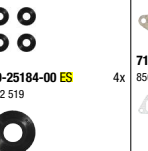
1,2 12 N 38-40 kW (52-55 PS) ASCONA B KADETT C KADETT D MANTA B 08/73-07/83

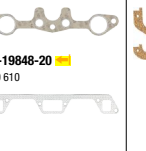
	<p>02-22930-06 16 06 675 +642 519 (4x)  12N 1154721</p>  <p>02-22930-08 16 06 675 +642 527 (8x)  12N 1154722→</p> 	<p>08-12803-02 16 06 668</p> 		<p>61-22930-40 607 985 80 Ø 1,3 mm</p> 	<p>14-32035-01 607 233 (5x) +607 234 (5x)</p> 	<p>71-12955-00 607 670</p> 	<p>12-25184-01 642 519 (4x)  12N 1154721</p> <p>12-26546-01 642 527 (8x)  12N 1154722→</p> 	<p>71-20634-20  850 618</p> <p>71-19848-20  850 610</p> <p>71-26198-10   854 945</p> 	<p>10-12803-02 16 06 228</p> 	<p>81-21343-00  614 818 54x82 A LD ACM</p> 
--	---	---	--	---	--	---	--	---	---	--

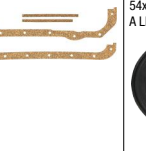
OPEL/VAUXHALL

Ltr. 											
1.2 12 NV 12 ST 37-40 kW (50-55 PS) CORSA A KADETT D NOVA NOVAVAN 08/82-10/94 		02-25895-02 16 06 674 +642 527 (8x) 	08-12996-07 16 06 680 		61-25895-20 607 989 79,3 Ø 1,3 mm 	14-32102-01 607 242 (10x) 	71-12995-00 638 644 	12-26546-01 642 527 (8x) 	71-24894-10  650 716  71-24602-30  850 615  70-26546-00 642 527  8x 71-25866-10   854 946 	71-12996-10 652 611 	81-24911-00  646 262 26x42 AB SL RD MVQ  81-24908-10  614 203 80x98 A SL LD FPM  81-24909-10 N 56 36 970 35x48 A SL RD MVQ 
1.2 12 S 40-44 kW (54-60 PS) ASCONA A ASCONA B ASTRA ASTRA II ASTRA V CORSA A KADETT B KADETT C KADETT D MANTA A MANTA B 08/71-08/91		02-22930-05  12 S 226296 	08-12803-02 16 06 668 		61-22930-40 607 985 80 Ø 1,3 mm  61-22930-60 607 467 80 Ø 1,7 mm 	14-32035-01 607 233 (5x) +607 234 (5x) 	71-12895-20 607 660  12 S 226296  71-12955-00 607 670  12 S 226297→ 	12-25184-01 642 519 (4x)  70-25184-00 ES 642 519  4x	71-20634-20  850 618  71-19848-20  850 610 	10-12803-02 16 06 228 	81-21343-00  614 818 54x82 A LD ACM 

OPEL/VAUXHALL															
1.2	12 SC	40 kW (55 PS)	KADETT E	09/84-07/86		02-22930-06 16 06 675 +642 519 (4x)	08-12803-02 16 06 668		61-22930-40 607 985 80 Ø 1,3 mm	14-32035-01 607 233 (5x) +607 234 (5x)	71-12955-00 607 670	12-25184-01 642 519 (4x)	71-20634-20 850 618 71-19848-20 850 610 71-26198-10 854 945	10-12803-02 16 06 228	81-21343-00 614 818 54x82 A LD ACM
1.2	13 N	39 kW (53 PS)	CHEVETTE	09/76-12/85		02-24885-04 16 06 676 +642 527 (8x) 13 N/S/C 1535880	08-12996-06 16 06 679		61-24885-20 607 990 76,5 Ø 1,3 mm	14-32102-01 607 242 (10x)	71-12995-00 638 644 13 N/S/C 1535880 71-13043-00 638 727 13 N/S/C 1535881→	12-26546-01 642 527 (8x)	71-24894-10 850 716 71-24602-30 850 615 71-25596-00 854 929 71-25866-10 854 946	71-12996-10 652 611	81-24911-00 646 262 26x42 AB SL RD MVQ 81-24908-10 614 203 80x98 A SL LD FPM 81-24909-10 N 56 36 970 35x48 A SL RD MVQ
1.3	A 13 DTC A 13 DTE A 13 DTR A 13 FD Z 13 DTE Z 13 DTI Z 13 DTR	55-70 kW (75-95 PS)	ASTRA IV CDTI ASTRA J CDTI ASTRA VI CDTI COMBO CDTI COMBO III CDTI CORSA D CDTI CORSA III CDTI CORSAVAN CORSAVAN III CDTI MERIVA B CDTI MERIVA II CDTI	07/06		02-36259-04 93 195 356	08-36261-05 66 06 040	04-10324-02	61-36210-00 56 07 639 70,5 Ø 0,72 mm MLS 61-36210-10 56 07 640 70,5 Ø 0,82 mm MLS 61-36210-20 56 07 641 70,5 Ø 0,92 mm MLS	14-32191-01 56 07 953 (10x)	71-36259-00 56 07 842	12-31306-12 642 533 (16x)	71-39538-00 850 933 71-36322-00 849 219 70-31306-00 642 533	70-31414-10	81-36233-00 646 910 40x52 AB SL RD FPM/ACM 81-36232-00 614 860 78x100 A SL LD PTFE

OPEL/VAUXHALL													
1,3	B 13 DTC B 13 DTE	55-70 kW (75-95 PS)	CORSA E CDTI CORSA IV CDTI CORSAVAN IV CDTI	08/14									
Ltr.													
1,3	B 13 DTC B 13 DTN B 13 DTR	55-70 kW (75-95 PS)	CORSA E CDTI CORSA IV CDTI CORSAVAN IV CDTI	08/14									
1,3	C 13 N	44 kW (60 PS)	CORSA A KADETT D KADETT E	08/79-08/91									

02-36210-01 56 07 639 70,5 Ø 0,72 mm MLS	08-36210-01 56 07 640 70,5 Ø 0,82 mm MLS	71-36261-00 55 186 663	61-36210-00 56 07 639 70,5 Ø 0,72 mm MLS 61-36210-10 56 07 640 70,5 Ø 0,82 mm MLS 61-36210-20 56 07 641 70,5 Ø 0,92 mm MLS	14-32191-01 56 07 953 (10x)	71-36259-00 56 07 842	12-31306-12 642 533 (16x)	71-39538-00 850 933 71-36322-00 849 219	70-31306-00 642 533	70-31414-10 	81-36233-00 646 910 40x52 AB SL RD FPM/ACM 81-36232-00 614 860 78x100 A SL LD PTFE
---	---	----------------------------------	---	---------------------------------------	---------------------------------	-------------------------------------	--	-------------------------------	------------------------	---

02-36210-01 56 07 639 70,5 Ø 0,72 mm MLS	08-36210-01 56 07 640 70,5 Ø 0,82 mm MLS	71-36261-00 55 186 663	61-36210-00 56 07 639 70,5 Ø 0,72 mm MLS 61-36210-10 56 07 640 70,5 Ø 0,82 mm MLS 61-36210-20 56 07 641 70,5 Ø 0,92 mm MLS	14-32191-01 56 07 953 (10x)	71-36259-00 56 07 842	12-31306-12 642 533 (16x)	71-39538-00 850 933 71-36322-00 849 219	70-31306-00 642 533	70-31414-10 	81-36233-00 646 910 40x52 AB SL RD FPM/ACM 81-36232-00 614 860 78x100 A SL LD PTFE
---	---	----------------------------------	---	---------------------------------------	---------------------------------	-------------------------------------	--	-------------------------------	------------------------	---

02-24885-05 16 06 681 +642 527 (8x)	08-12996-05 16 06 728	61-24885-20 607 990 76,5 Ø 1,3 mm	14-32102-01 607 242 (10x)	71-13043-00 638 727	12-26546-01 642 527 (8x)	71-24894-10 850 716 71-24602-30 850 615 71-25866-10 854 946	71-24908-10 614 203 80x98 A SL LD FPM	71-24909-10 56 36 970 35x48 A SL RD MVQ
--	---------------------------------	---	-------------------------------------	-------------------------------	------------------------------------	---	---	---

02-24885-05 16 06 681 +642 527 (8x)	08-12996-05 16 06 728	61-24885-20 607 990 76,5 Ø 1,3 mm	14-32102-01 607 242 (10x)	71-13043-00 638 727	12-26546-01 642 527 (8x)	71-24894-10 850 716 71-24602-30 850 615 71-25866-10 854 946	71-24908-10 614 203 80x98 A SL LD FPM	71-24909-10 56 36 970 35x48 A SL RD MVQ
--	---------------------------------	---	-------------------------------------	-------------------------------	------------------------------------	---	---	---

OPEL/VAUXHALL													
1,3	D 13 A Y 13 DT Z 13 DT Z 13 DTJ	51-59 kW (69-80 PS)	AGILA CDTI CAMPO TD COMBO CDTI COMBO II CDTI CORSA C CDTI CORSA C CDTI CORSA D CDTI CORSA II CDTI CORSA III CDTI CORSAVAN II CDTI CORSAVAN III CDTI MERIVA CDTI TIGRA CDTI	01/03									
Ltr.													
1,3	Z 13 DTH	66 kW (90 PS)	ASTRA CDTI ASTRA H CDTI ASTRA V CDTI CORSA D CDTI CORSA III CDTI CORSAVAN III CDTI	01/04									
1,3	Z 13 DTH	66 kW (90 PS)	ASTRA H CDTI	01/09									

OPEL/VAUXHALL

Ltr.	13 N	39-44 kW (53-60 PS)	ASCONA B ASCONA C CAVALIER CHEVETTE KADETT D KADETT E MANTA B	03/75-08/91											
1,3	13 N					<p>02-24885-04 16 06 676 +642 527 (8x) ➔ 13 N/S/C 1535880</p> <p>02-24885-05 16 06 681 +642 527 (8x) ➔ 13 N/S/C 1535881➔</p>	<p>08-12996-06 16 06 679</p>		<p>61-24885-20 607 990 76,5 Ø 1,3 mm</p>	<p>14-32102-01 607 242 (10x)</p>	<p>71-12995-00 638 644 ➔ 13 N/S/C 1535880</p> <p>71-13043-00 638 727 ➔ 13 N/S/C 1535881➔</p>	<p>12-26546-01 642 527 (8x)</p> <p>70-26546-00 642 527</p>	<p>71-24894-10 </p> <p>646 262 850 615</p> <p>71-24602-30 </p> <p>850 615</p> <p>71-25596-00 </p> <p>854 929</p> <p>71-25866-10 </p> <p>854 946</p>	<p>71-12996-10 652 611</p>	<p>81-24911-00 </p> <p>646 262 26x42 AB SL RD MVQ</p> <p>81-24908-10 </p> <p>614 203 80x98 A SL LD FPM</p> <p>81-24909-10 N</p> <p>56 36 970 35x48 A SL RD MVQ</p>
1,3	13 NB	44 kW (60 PS)	ASTRAMAX CORSA A CORSA B CORSA C KADETT E	09/84-12/02		<p>02-24885-05 16 06 681 +642 527 (8x)</p> <p>08-12996-06 16 06 679</p>		<p>61-24885-20 607 990 76,5 Ø 1,3 mm</p>	<p>14-32102-01 607 242 (10x)</p>	<p>71-13043-00 638 727</p>	<p>12-26546-01 642 527 (8x)</p> <p>70-26546-00 642 527</p>	<p>71-24894-10 </p> <p>646 262 850 615</p> <p>71-24602-30 </p> <p>850 615</p> <p>71-25596-00 </p> <p>854 929</p> <p>71-25866-10 </p> <p>854 946</p>	<p>71-12996-10 652 611</p>	<p>81-24911-00 </p> <p>646 262 26x42 AB SL RD MVQ</p> <p>81-24908-10 </p> <p>614 203 80x98 A SL LD FPM</p> <p>81-24909-10 N</p> <p>56 36 970 35x48 A SL RD MVQ</p>	





























OPEL/VAUXHALL

Ltr.	1,3	13 S 13 SB	42-55 kW (57-75 PS)	ASCONA B ASCONA C ASTRA ASTRA II ASTRA V ASTRAMAX CAVALIER II CHEVETTE CORSA A KADETT D KADETT E MANTA B NOVA	09/74-02/93										
1,3	13 S 13 SB	42-55 kW (57-75 PS)	ASCONA B ASCONA C ASTRA ASTRA II ASTRA V ASTRAMAX CAVALIER II CHEVETTE CORSA A KADETT D KADETT E MANTA B NOVA	09/74-02/93		<p>02-24885-04 16 06 676 +642 527 (8x) ➔ 13 S 19417531</p> <p>02-24885-05 16 06 681 +642 527 (8x) ➔ 13 S 19417532➔</p>	<p>08-12996-06 16 06 679</p>		<p>61-24885-20 607 990 76,5 Ø 1,3 mm</p>	<p>14-32102-01 607 242 (10x)</p>	<p>71-12995-00 638 644 ➔ 13 S 19417531</p> <p>71-13043-00 638 727 ➔ 13 S 19417532➔</p>	<p>12-26546-01 642 527 (8x)</p> <p>70-26546-00 642 527</p>	<p>71-24894-10 </p> <p>850 716</p> <p>71-24602-30 </p> <p>850 615</p> <p>71-25596-00 </p> <p>854 929</p> <p>71-25866-10 </p> <p>854 946</p>	<p>71-12996-10 652 611</p>	<p>81-24911-00 </p> <p>646 262 26x42 AB SL RD MVQ</p> <p>81-24908-10 </p> <p>614 203 80x98 A SL LD FPM</p> <p>81-24909-10 N</p> <p>56 36 970 35x48 A SL RD MVQ</p>
1,4	A 14 FC	88 kW (120 PS)	COMBO COMBO CNG	02/12		<p>02-38835-01 95 512 710</p>	<p>08-37464-01</p>		<p>61-38835-00 55 206 232 73 Ø MLS</p>	<p>14-35731-01 607 518 (10x)</p>	<p>71-35621-10 55 194 045</p>	<p>12-33512-02 44 23 068(8X)</p> <p>70-33512-00 642 542</p>	<p>11-38834-01 </p> <p>95 512 865</p> <p>71-38831-00 </p> <p>95 512 876</p>	<p>70-31414-10</p>	<p>81-37461-00 </p> <p>95 512 889 27x37 AB RD FPM</p> <p>81-90041-00 </p> <p>95 512 715 FPM/ACM</p> <p>81-35623-00 N</p> <p>55 195 339 40x55 AB SL RD FPM/ACM</p>























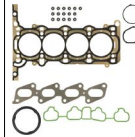
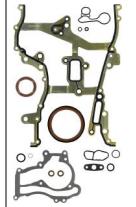

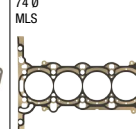
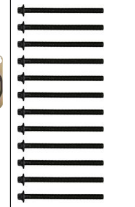
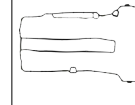

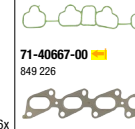





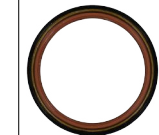
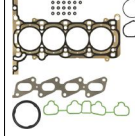
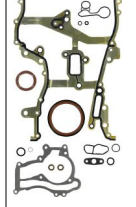



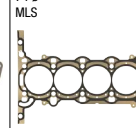

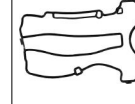
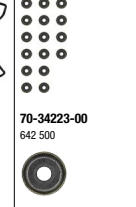

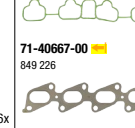





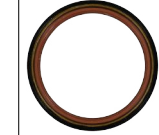
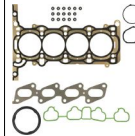
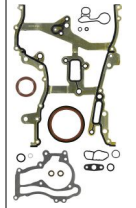

OPEL/VAUXHALL

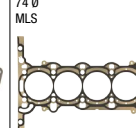
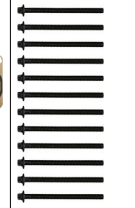
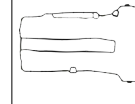
OPEL/VAUXHALL																
1,4	A 14 FP	70 kW (95 PS)	COMBO	11/11		02-37110-02 95 513 830 	08-37464-01 	61-37110-00 55 202 800 73 Ø MLS 	14-35731-01 607 518 (10x) 	71-35621-10 55 194 045 	12-33512-02 44 23 068(8X) 	11-37648-01 95 512 853 	70-31414-10 	81-37461-00 95 512 889 27x37 AB RD FPM 	81-90041-00 95 512 715 FPM/ACM 	81-35623-00 N 95 195 339 40x55 AB SL RD FPM/ACM
1,4	A 14 NEL A 14 NET	88-103 kW (120-140 PS)	CASCADA CASCADA Turbo	03/13-04/18		02-37875-03 16 29 027 	08-40999-01 16 06 417 	04-10330-01 	61-37875-00 607 161 74 Ø MLS 	14-32331-01 607 165 (12x) 	71-17813-00 25 198 753 	12-34223-02 642 500 (16x) 	71-40672-00 850 096 	70-31414-10 	81-33489-10 20 91 167 42x55 RD FPM 	81-24908-10 614 203 80x98 A SL LD FPM
1,4	A 14 NEL A 14 NET B 14 NEL B 14 NET	88-103 kW (120-140 PS)	ASTRA ASTRA IV Turbo ASTRA VI ASTRA VI Turbo CORSA II MERIVA II TURBO ZAFIRA III	12/09		02-37875-03 16 29 027 	08-40999-01 16 06 417 	04-10303-01 	61-37875-00 607 161 74 Ø MLS 	14-32331-01 607 165 (12x) 	71-40674-00 642 026 19EN7802 	12-34223-02 642 500 (16x) 	71-40672-00 850 096 	70-31414-10 	81-33489-10 20 91 167 42x55 RD FPM 	81-24908-10 614 203 80x98 A SL LD FPM

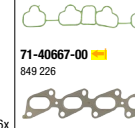
OPEL/VAUXHALL

Ltr.														
1,4	A 14 NEL A 14 NET B 14 NEL B 14 NET	88-103 kW (120-140 PS)	ASTRA J ASTRA J LPG ASTRA J Turbo CORSA D INSIGNIA LPG MERIVA B MERIVA B LPG ZAFIRA ZAFIRA LPG	12/09	02-37875-03 16 29 027	08-40999-01 16 06 417	04-10330-01 	61-37875-00 607 161 74 0 MLS	14-32331-01 607 165 (12x)	71-40674-00 642 026 ➔ 19EN7802	12-34223-02 642 500 (16x)	71-40672-00  850 096	70-31414-10 	81-33489-10  20 91 167 42x55 RD FPM 81-24908-10  614 203 80x98 A SL LD FPM
1,4	A 14 NEL A 14 NET B 14 NEL B 14 NET D 14 NET	88-103 kW (120-140 PS)	ASTRA J ASTRA J Turbo INSIGNIA INSIGNIA LPG MERIVA B MERIVA B LPG MOKKA LPG	06/10	02-37875-03 16 29 027	08-40999-01 16 06 417	04-10330-01 	61-37875-00 607 161 74 0 MLS	14-32331-01 607 165 (12x)	71-40674-00 642 026 ➔ 19EN7802	12-34223-02 642 500 (16x)	71-40672-00  850 096	70-31414-10 	81-33489-10  20 91 167 42x55 RD FPM 81-24908-10  614 203 80x98 A SL LD FPM
1,4	A 14 NEL B 14 NEL B 14 NET	88-103 kW (120-140 PS)	ASTRA MERIVA II LPG MERIVA II TURBO ZAFIRA III	12/09	02-37875-03 16 29 027	08-40999-01 16 06 417	04-10303-01 	61-37875-00 607 161 74 0 MLS	14-32331-01 607 165 (12x)	71-40674-00 642 026 ➔ 19EN7802	12-34223-02 642 500 (16x)	71-40672-00  850 096	70-31414-10 	81-33489-10  20 91 167 42x55 RD FPM 81-24908-10  614 203 80x98 A SL LD FPM

OPEL/VAUXHALL

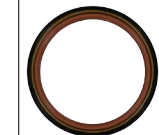
Ltr. 	1,4 A 14 NET	103 kW (140 PS)	INSIGNIA LPG	 07/12-05/17											
1,4 A 14 NET B 14 NET	103 kW (140 PS)	CASCADA		02/13	<p>02-37875-03 16 29 027</p> 	<p>08-40999-01 16 06 417</p> 	<p>04-10303-01 </p> 	<p>61-37875-00 607 161 74 Ø MLS</p> 	<p>14-32331-01 607 165 (12x)</p> 	<p>71-40674-00 642 026</p> 	<p>12-34223-02 642 500 (16x)</p> 	<p>71-40672-00 </p> <p>850 096</p>  <p>71-40667-00 </p> <p>849 226</p> 	<p>70-31414-10</p> 	<p>81-33489-10 </p> <p>20 91 167 42x55 RD FPM</p>  <p>81-24908-10 </p> <p>614 203 80x98 A SL LD FPM</p> 	
1,4 A 14 NET B 14 NET	103 kW (140 PS)	INSIGNIA		04/11-05/17	<p>02-37875-03 16 29 027</p> 	<p>08-40999-01 16 06 417</p> 	<p>04-10303-01 </p>  <p>71-40668-00 </p> <p>638 130</p> 	<p>61-37875-00 607 161 74 Ø MLS</p> 	<p>14-32331-01 607 165 (12x)</p> 	<p>71-17813-00 25 198 753</p> 	<p>12-34223-02 642 500 (16x)</p> 	<p>71-40672-00 </p> <p>850 096</p>  <p>71-40667-00 </p> <p>849 226</p> 	<p>70-31414-10</p> 	<p>81-33489-10 </p> <p>20 91 167 42x55 RD FPM</p>  <p>81-24908-10 </p> <p>614 203 80x98 A SL LD FPM</p> 	
1,4 A 14 NET B 14 NET	103 kW (140 PS)	INSIGNIA		04/11-05/17	<p>02-37875-03 16 29 027</p> 	<p>08-40999-01 16 06 417</p> 	<p>04-10303-01 </p>  <p>71-40668-00 </p> <p>638 130</p> 	<p>61-37875-00 607 161 74 Ø MLS</p> 	<p>14-32331-01 607 165 (12x)</p> 	<p>71-40674-00 642 026</p> 	<p>12-34223-02 642 500 (16x)</p> 	<p>71-40672-00 </p> <p>850 096</p>  <p>71-40667-00 </p> <p>849 226</p> 	<p>70-31414-10</p> 	<p>81-33489-10 </p> <p>20 91 167 42x55 RD FPM</p>  <p>81-24908-10 </p> <p>614 203 80x98 A SL LD FPM</p> 	

OPEL/VAUXHALL

OPEL/VAUXHALL														
Ltr.														
1,4 A 14 NET B 14 NET	103 kW (140 PS) MOKKA	06/12												
					02-37875-03 16 29 027	08-40999-01 16 06 417	04-10303-01 607 161 74 0 MLS 04-10330-01 71-40668-00 638 130	61-37875-00 607 161 74 0 MLS	14-32331-01 607 165 (12x)	71-40674-00 642 026 ➔ 19EN7802	12-34223-02 642 500 (16x)	71-40672-00 850 096 71-40667-00 849 226	70-31414-10	81-33489-10 20 91 167 42x55 RD FPM 81-24908-10 614 203 80x98 A SL LD FPM
1,4 A 14 XEL	64 kW (87 PS) ADAM ADAM LPG	10/12-02/19	01-37875-02	02-37875-04			61-37875-00 607 161 74 0 MLS	14-32331-01 607 165 (12x)	71-17813-00 25 198 753	12-34223-02 642 500 (16x)	71-40686-00 850 092	70-31414-10	81-33489-10 20 91 167 42x55 RD FPM 81-24908-10 614 203 80x98 A SL LD FPM	
1,4 A 14 XEL A 14 XER	64-74 kW (87-101 PS) ASTRA ASTRA IV ASTRA J ASTRA VI CORSA D CORSA III MERIVA B	09/09-03/17	01-37875-02	02-37875-04			61-37875-00 607 161 74 0 MLS	14-32331-01 607 165 (12x)	71-40674-00 642 026 ➔ 19EN7802	12-34223-02 642 500 (16x)	71-40686-00 850 092	70-31414-10	81-33489-10 20 91 167 42x55 RD FPM 81-24908-10 614 203 80x98 A SL LD FPM	
									71-17813-00 25 198 753 ➔ 19EN7803➔	70-34223-00 642 500	71-40694-00 860 155 71-36304-00 849 541			

OPEL/VAUXHALL

Ltr.	Engine	Power	Model	Year	01-37875-02	02-37875-04												
1,4	A 14 XEL A 14 XER D 14 XER	64-74 kW (87-101 PS)	ADAM ASTRA J LPG	10/12-02/19														
					01-37875-02	02-37875-04		71-40668-00 638 130	61-37875-00 607 161 74 Ø MLS	14-32331-01 607 165 (12x)	71-17813-00 25 198 753	12-34223-02 642 500 (16x)	71-40686-00 850 092	70-31414-10	81-33489-10 K↔ 20 91 167 42x55 RD FPM			
					01-37875-02	02-37875-04			61-37875-00 607 161 74 Ø MLS	14-32331-01 607 165 (12x)	71-40674-00 642 026 19EN7802	12-34223-02 642 500 (16x)	71-40686-00 850 092	70-31414-10	81-33489-10 K↔ 20 91 167 42x55 RD FPM			
					01-37875-02	02-37875-04			61-37875-00 607 161 74 Ø MLS	14-32331-01 607 165 (12x)	71-17813-00 25 198 753	12-34223-02 642 500 (16x)	71-40686-00 850 092	70-31414-10	81-33489-10 K↔ 20 91 167 42x55 RD FPM			
					01-37875-02	02-37875-04			61-37875-00 607 161 74 Ø MLS	14-32331-01 607 165 (12x)	71-40674-00 642 026	12-34223-02 642 500 (16x)	71-40686-00 850 092	70-31414-10	81-33489-10 K↔ 20 91 167 42x55 RD FPM			
					01-37875-02	02-37875-04			61-37875-00 607 161 74 Ø MLS	14-32331-01 607 165 (12x)	71-17813-00 25 198 753	12-34223-02 642 500 (16x)	71-40686-00 850 092	70-31414-10	81-33489-10 K↔ 20 91 167 42x55 RD FPM			
					01-37875-02	02-37875-04			61-37875-00 607 161 74 Ø MLS	14-32331-01 607 165 (12x)	71-40674-00 642 026	12-34223-02 642 500 (16x)	71-40686-00 850 092	70-31414-10	81-33489-10 K↔ 20 91 167 42x55 RD FPM			

OPEL/VAUXHALL













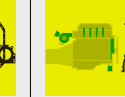

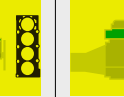
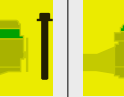
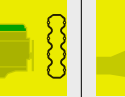

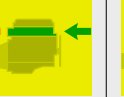

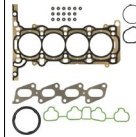
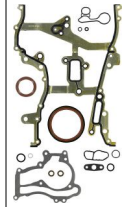



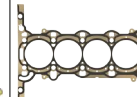
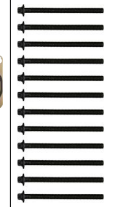





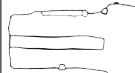

Ltr.	Motor	Power	Model	Year	01-37875-02	02-37875-04									
1,4	A 14 XER	74 kW (101 PS)	MERIVA II	06/10											
1,4	A 14 XFL	111 kW (151 PS)	AMPERA	11/11											
1,4	B 14 NEH D 14 NEH	110 kW (150 PS)	ADAM ADAM TURBO CORSA E Turbo CORSA IV	11/14											

OPEL/VAUXHALL













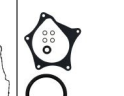
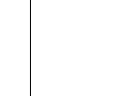

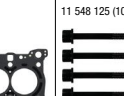

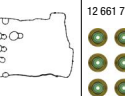
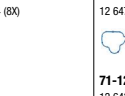
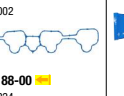

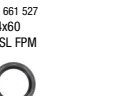
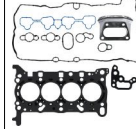

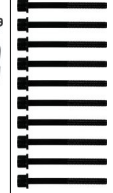
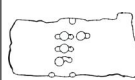
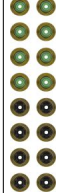
OPEL/VAUXHALL													
Ltr.													
1,4 B 14 NEJ	74 kW (101 PS) CORSA E Turbo	09/14-06/19	1										
				<p>02-10021-01 16 29 142</p>	<p>08-40999-01 16 06 417</p>	<p>04-10330-01 </p> <p>71-40668-00 </p> 638 130	<p>61-37875-00 607 161 74 Ø MLS</p>	<p>14-32331-01 607 165 (12x)</p>	<p>71-17813-00 25 198 753</p>	<p>12-34223-02 642 500 (16x)</p>	<p>71-40672-00 </p> 850 096 <p>71-40667-00 </p> 849 226	<p>70-31414-10</p>	<p>81-33489-10 </p> 20 91 167 42x55 RD FPM <p>81-24908-10 </p> 614 203 80x98 A SL LD FPM
1,4 B 14 NEJ	74 kW (101 PS) CORSA IV	08/14											
				<p>02-10021-01 16 29 142</p>	<p>08-40999-01 16 06 417</p>	<p>04-10330-01 </p> <p>71-40668-00 </p> 638 130	<p>61-37875-00 607 161 74 Ø MLS</p>	<p>14-32331-01 607 165 (12x)</p>	<p>71-17813-00 25 198 753 19EN7802</p>	<p>12-34223-02 642 500 (16x)</p>	<p>71-40672-00 </p> 850 096 <p>71-40667-00 </p> 849 226	<p>70-31414-10</p>	<p>81-33489-10 </p> 20 91 167 42x55 RD FPM <p>81-24908-10 </p> 614 203 80x98 A SL LD FPM
1,4 B 14 NEL B 14 NET D 14 NEL	88-103 kW (120-140 PS) ASTRA J Turbo CASCADA Turbo MOKKA	12/09											
				<p>02-37875-03 16 29 027</p>	<p>08-40999-01 16 06 417</p>	<p>04-10330-01 </p> <p>71-40668-00 </p> 638 130	<p>61-37875-00 607 161 74 Ø MLS</p>	<p>14-32331-01 607 165 (12x)</p>	<p>71-17813-00 25 198 753</p> <p>71-40674-00 642 026</p>	<p>12-34223-02 642 500 (16x)</p> <p>70-34223-00 642 500</p> 16x	<p>71-40672-00 </p> 850 096 <p>71-40667-00 </p> 849 226	<p>70-31414-10</p>	<p>81-33489-10 </p> 20 91 167 42x55 RD FPM <p>81-24908-10 </p> 614 203 80x98 A SL LD FPM

OPEL/VAUXHALL

Ltr.  1,4 B 14 NET
 103 kW (140 PS)
 INSIGNIA MOKKA
 04/11

											
	<p>02-37875-03 16 29 027</p> 	<p>08-40999-01 16 06 417</p> 	<p>04-10330-01 </p>  <p>71-40668-00 </p> <p>638 130</p> 	<p>61-37875-00 607 161 74 Ø MLS</p> 	<p>14-32331-01 607 165 (12x)</p> 	<p>71-40674-00 642 026  → 19EN7802</p>  <p>71-17813-00 25 198 753  → 19EN7803→</p>  <p>71-17813-00 25 198 753</p>  <p>71-40674-00 642 026</p> 	<p>12-34223-02 642 500 (16x)</p>  <p>70-34223-00 642 500</p>  <p>16x</p>	<p>71-40672-00 </p> <p>850 096</p>  <p>71-40667-00 </p> <p>849 226</p> 	<p>70-31414-10</p> 	<p>81-33489-10 </p> <p>20 91 167 42x55 RD FPM</p>  <p>81-24908-10 </p> <p>614 203 80x98 A SL LD FPM</p> 	

1,4 B 14 XE
 74 kW (100 PS)
 ASTRA K
 ASTRA VII
 06/15

											
	<p>02-10180-02 12 643 224 +12 668 644</p> 	<p>08-10180-02</p> 		<p>61-10180-00 12 663 440 MLS</p> 	<p>14-10015-01 11 548 125 (10x)</p> 	<p>15-10042-01</p> 	<p>12-10011-01 12 661 724 (8x)</p> 	<p>71-12420-00 </p> <p>12 647 002</p>  <p>71-12188-00 </p> <p>12 643 224</p> 	<p>70-31414-10</p> 	<p>81-10458-00 </p> <p>12 661 527 44x60 A SL FPM</p>  <p>81-10457-00 </p> <p>12 653 685 84x100 A SL LD FPM</p>  <p>81-10459-00 N</p> <p>12 638 690 37x54 FPM</p> 	

OPEL/VAUXHALL													
Ltr.													
1,4 B 14 XEJ B 14 XEL D 14 XEL	55-66 kW (75-90 PS)	ADAM ADAM LPG CORSA E CORSA E LPG CORSA IV	10/12										
1,4 B 14 XER	74 kW (100 PS)	MERIVA B	06/10-03/17										
1,4 B 14 XER	74 kW (100-101 PS)	ASTRA ASTRA J ASTRA VI	12/09-10/15										

























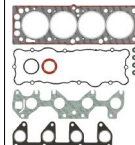

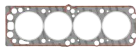









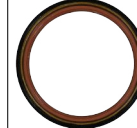

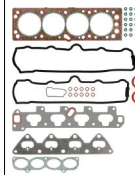



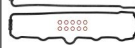

OPEL/VAUXHALL

Ltr.	1.4 B 14 XER	74 kW (101 PS)	ADAM ASTRA J	10/10-02/19											
1.4 B 14 XER	74 kW (101 PS)	MERIVA II	06/10	<p>01-37875-02</p>	<p>02-37875-04</p>		<p>71-40668-00 </p> <p>638 130</p>	<p>61-37875-00</p> <p>607 161 74 Ø MLS</p>	<p>14-32331-01</p> <p>607 165 (12x)</p>	<p>71-17813-00</p> <p>25 198 753</p>	<p>12-34223-02</p> <p>642 500 (16x)</p>	<p>71-40686-00 </p> <p>850 092</p>	<p>70-31414-10</p>	<p>81-33489-10 </p> <p>20 91 167 42x55 RD FPM</p>	
1.4 B 14 XER	74 kW (101 PS)	MERIVA II	06/10	<p>01-37875-02</p>	<p>02-37875-06</p> <p>16 29 009 → bis C4999999</p>	<p>08-10027-01</p> <p>16 06 326</p>	<p>71-40668-00 </p> <p>638 130</p>	<p>61-37875-00</p> <p>607 161 74 Ø MLS</p>	<p>14-32331-01</p> <p>607 165 (12x)</p>	<p>71-40674-00</p> <p>642 026 → 19EN7802</p>	<p>12-34223-02</p> <p>642 500 (16x)</p>	<p>71-40686-00 </p> <p>850 092</p>	<p>70-31414-10</p>	<p>81-33489-10 </p> <p>20 91 167 42x55 RD FPM</p>	
1.4 B 14 XFL B 14 XFT B 14 XNT D 14 XFL D 14 XFT	81-112 kW (110-152 PS)	ASTRA K ASTRA K CNG ASTRA K Turbo ASTRA VII Turbo MOKKA	06/15	<p>02-37875-05</p> <p>16 29 140 → D4000001→</p>	<p>02-10180-03</p> <p>12 664 831 +12 662 184</p>	<p>08-10180-03</p>	<p>04-10338-01 </p>	<p>61-10180-00</p> <p>12 663 440 MLS</p>	<p>14-10015-01</p> <p>11 548 125 (10x)</p>	<p>15-10043-01</p>	<p>12-10011-01</p> <p>12 661 724 (8x)</p>	<p>71-12158-00 </p> <p>12 637 018</p>	<p>70-31414-10</p>	<p>81-10458-00 </p> <p>12 661 527 44x60 A SL FPM</p>	
												<p>71-12187-00 </p> <p>12 657 786</p>		<p>81-10457-00 </p> <p>12 653 685 84x100 A SL LD FPM</p>	
														<p>81-10459-00 </p> <p>12 638 690 37x54 FPM</p>	

OPEL/VAUXHALL



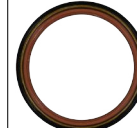









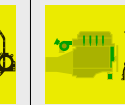
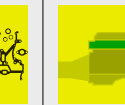
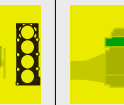

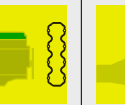
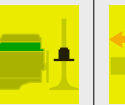
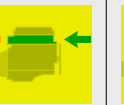

OPEL/VAUXHALL															
1.4	C 14 NZ X 14 NZ X 14 SZ 14 NV	40-55 kW (54-75 PS)	ASTRA F ASTRA II ASTRA III ASTRAMAX CAVALIER III COMBO CORSA CORSA A CORSA B CORSAVAN KADETT E NOVA NOVAVAN VECTRA A		01/85-01/05		<p>02-28135-01 16 06 697 +642 527 (8x) ➡ 19489817</p> <p>02-28135-03 16 06 035 +642 527 (8x) ➡ 19489818→</p>	<p>08-12996-05 16 06 728</p> <p>08-31226-01 </p> <p>16 06 790</p>	<p>61-28135-00 56 07 425 79,3 Ø 1,95 mm</p>	<p>14-32102-01 607 242 (10x)</p>	<p>71-13043-00 638 727 ➡ 19489817</p> <p>71-29303-00 638 260 ➡ 19489818→</p>	<p>12-26546-01 642 527 (8x)</p> <p>70-26546-00 642 527</p>	<p>71-28182-10 </p> <p>850 522</p> <p>71-24602-30 </p> <p>850 615</p> <p>8x</p>	<p>71-12996-10 652 611</p> <p>71-31226-00 </p> <p>652 669</p>	<p>81-27295-00 </p> <p>646 274 26x42 AB SL RD FPM</p> <p>81-24908-10 </p> <p>614 203 80x98 A SL LD FPM</p> <p>81-24909-10 N 56 36 970 35x48 A SL RD MVQ</p>
1.4	C 14 NZ	44 kW (60 PS)	CORSA C	08/94-07/02			<p>02-29270-01 16 06 701 +642 527 (8x) ➡ 19718215</p>	<p>08-12996-05 16 06 728</p>	<p>61-29270-00 607 998 1,3 mm</p>	<p>14-32102-01 607 242 (10x)</p>	<p>71-13043-00 638 727 ➡ 19718215</p> <p>71-29303-00 638 260 ➡ 19718216→</p>	<p>12-26546-01 642 527 (8x)</p> <p>70-26546-00 642 527</p>	<p>71-28182-10 </p> <p>850 522</p> <p>71-24602-30 </p> <p>850 615</p> <p>8x</p>	<p>71-12996-10 652 611</p>	<p>81-27295-00 </p> <p>646 274 26x42 AB SL RD FPM</p> <p>81-24908-10 </p> <p>614 203 80x98 A SL LD FPM</p> <p>81-24909-10 N 56 36 970 35x48 A SL RD MVQ</p>

OPEL/VAUXHALL











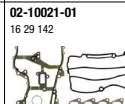
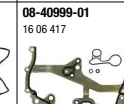
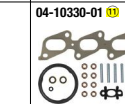
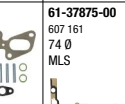
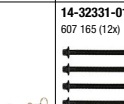
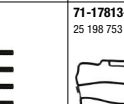
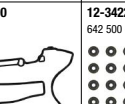
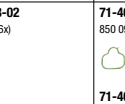
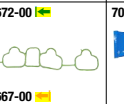

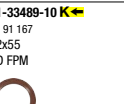
Ltr. 													
1,4 C 14 SE 14 SE	54-60 kW (73-82 PS) ASTRA F ASTRA III COMBO CORSA CORSA A CORSA B KADETT E NOVA	09/89-10/01		02-28135-02 16 06 730 +642 527 (8x)	08-12996-05 16 06 728  08-31226-01  16 06 790		61-28135-00 56 07 425 79,3 Ø 1,95 mm	14-32102-01 607 242 (10x) 	71-29303-00 638 260 	12-26546-01 642 527 (8x)  70-26546-00 642 527	71-29302-00  850 607 71-24602-30  850 615 8x	71-12996-10 652 611  71-31226-00  652 669	81-27295-00  646 274 26x42 AB SL RD FPM 81-24908-10  614 203 80x98 A SL LD FPM 81-24909-10  N 56 36 970 35x48 A SL RD MVQ 81-24908-10  K
1,4 C 14 SEL X 14 XE	63-66 kW (86-90 PS) COMBO CORSA CORSA B TIGRA	07/94-12/02		02-31985-01 16 06 034 +642 533 (16x)	08-12996-05 16 06 728  08-31226-01  16 06 790		61-31985-10 56 07 410 80 Ø 1,3 mm	14-32103-01 90 412 701 (10x) 	15-31973-01 638 736 +638 737 	12-31306-01 642 533 (16x)  70-31306-10 642 533 16x	71-31966-10  850 668 71-31963-00  58 50 612  71-31969-00  58 50 613	71-12996-10 652 611  71-31226-00  652 669	81-27295-00  646 274 26x42 AB SL RD FPM 81-24908-10  K 614 203 80x98 A SL LD FPM 81-24909-10  N 56 36 970 35x48 A SL RD MVQ 81-24908-10  K 2x

OPEL/VAUXHALL











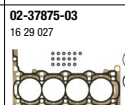
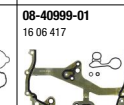

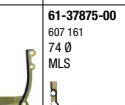
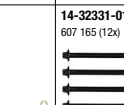
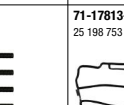
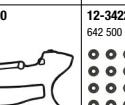
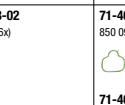
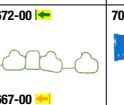

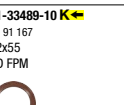
Ltr.  1,4 D 14 NEJ  74 kW (101 PS) CORSA E Turbo  09/14-06/19

											
	02-10021-01 16 29 142	08-40999-01 16 06 417		61-37875-00 607 161 74 Ø MLS	14-32331-01 607 165 (12x)	71-17813-00 25 198 753	12-34223-02 642 500 (16x)	71-40672-00  850 096  71-40667-00  849 226 	70-31414-10 	81-33489-10  20 91 167 42x55 RD FPM  81-24908-10  614 203 80x98 A SL LD FPM 	



























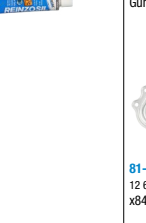





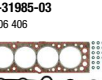
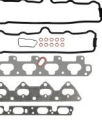
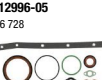





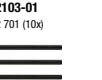

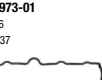
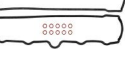

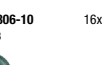
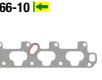



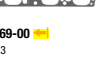

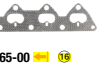



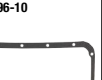
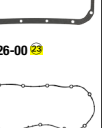







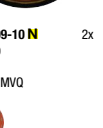

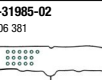
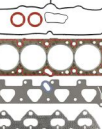
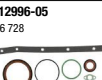



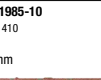
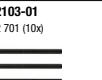

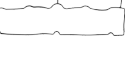

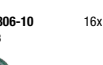
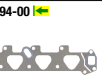





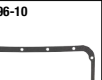
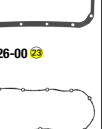

1,4 D 14 NEJ 74 kW (101 PS) CORSA IV 08/14

											
	02-10021-01 16 29 142	08-40999-01 16 06 417	04-10330-01 	61-37875-00 607 161 74 Ø MLS	14-32331-01 607 165 (12x)	71-17813-00 25 198 753	12-34223-02 642 500 (16x)	71-40672-00  850 096  71-40667-00  849 226 	70-31414-10 	81-33489-10  20 91 167 42x55 RD FPM  81-24908-10  614 203 80x98 A SL LD FPM 	











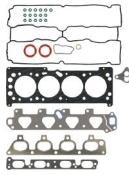



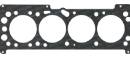

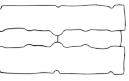
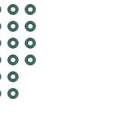

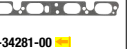







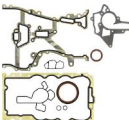

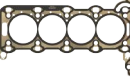
1,4 D 14 NET 103 kW (140 PS) ASTRA 12/09-10/15

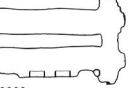
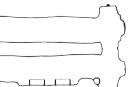
											
	02-37875-03 16 29 027	08-40999-01 16 06 417	71-40668-00  638 130	61-37875-00 607 161 74 Ø MLS	14-32331-01 607 165 (12x)	71-17813-00 25 198 753	12-34223-02 642 500 (16x)	71-40672-00  850 096  71-40667-00  849 226 	70-31414-10 	81-33489-10  20 91 167 42x55 RD FPM  81-24908-10  614 203 80x98 A SL LD FPM 	

























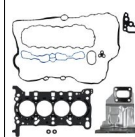



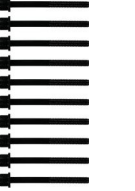
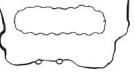
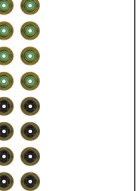









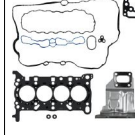



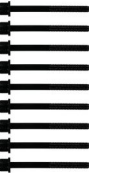

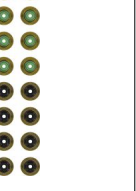
OPEL/VAUXHALL

<p>Ltr.  1,4 F 14 SHL F 14 SHT</p> <p>107 kW (145 PS)</p> <p> ASTRA K ASTRA VII Turbo INSIGNIA B</p> <p>08/19 [NEW]</p>		 <p>02-10823-02</p>	 <p>08-10159-01</p>		 <p>61-10823-00 12 696 638 80 Ø MLS</p>	 <p>14-18396-01 11 547 729 (8X)</p> 	 <p>15-18403-01</p> 	 <p>12-21042-01 12 661 724 (6X)</p>	 <p>11-10956-01  12 667 033</p>  <p>11-18407-01 </p>	 <p>70-31414-10</p> 	 <p>81-10608-00  12 697 665 Gummi/Metall</p>  <p>81-10609-00  12 664 808 x84</p>
<p>1,4 X 14 XE</p> <p>66 kW (90 PS)</p> <p> ASTRA F ASTRA III</p> <p>01/96-03/01</p>		 <p>02-31985-03 16 06 406</p> 	 <p>08-12996-05 16 06 728</p>  <p>08-31226-01  16 06 790</p> 		 <p>61-31985-10 56 07 410 80 Ø 1,3 mm</p>	 <p>14-32103-01 90 412 701 (10x)</p> 	 <p>15-31973-01 638 736 +638 737</p> 	 <p>12-31306-01 642 533 (16x)</p>  <p>70-31306-10 642 533</p>  <p>16x</p>	 <p>71-31966-10  850 668</p>  <p>71-34274-00   58 50 624</p>  <p>71-31969-00  58 50 613</p>  <p>71-25865-00   854 933</p> 	 <p>71-12996-10 652 611</p>  <p>71-31226-00  652 669</p> 	 <p>81-27295-00  646 274 26x42 AB SL RD FPM</p>  <p>81-24908-10  614 203 80x98 A SL LD FPM</p>  <p>81-24909-10 N 2x 56 36 970 35x48 A SL RD MVQ</p> 
<p>1,4 X 14 XE</p> <p>66 kW (90 PS)</p> <p> ASTRA G ASTRA G LPG ASTRA IV</p> <p>02/98-05/05</p>		 <p>02-31985-02 16 06 381</p> 	 <p>08-12996-05 16 06 728</p>  <p>08-31226-01  16 06 790</p> 		 <p>61-31985-10 56 07 410 80 Ø 1,3 mm</p>	 <p>14-32103-01 90 412 701 (10x)</p> 	 <p>71-34288-00 638 742</p> 	 <p>12-31306-01 642 533 (16x)</p>  <p>70-31306-10 642 533</p>  <p>16x</p>	 <p>71-34294-00  849 196</p>  <p>71-34274-00   58 50 624</p>  <p>71-31969-00  58 50 613</p>  <p>71-25865-00   854 933</p> 	 <p>71-12996-10 652 611</p>  <p>71-31226-00  652 669</p> 	 <p>81-27295-00  646 274 26x42 AB SL RD FPM</p>  <p>81-24908-10  614 203 80x98 A SL LD FPM</p>  <p>81-24909-10 N 2x 56 36 970 35x48 A SL RD MVQ</p> 

OPEL/VAUXHALL

Ltr.	Z	kW (PS)	Model	Date			02-34235-01 16 06 097 			08-25879-01 16 06 096 02MZ5254, 20U75999  08-35564-01 16 06 170 02MZ5255, 20M76000→ 20DS3826  08-35564-03 20DS3827→ 								61-34235-00 607 410 79,5 Ø MLS 			14-32103-01 90 412 701 (10x) 			71-34288-00 638 742 			12-31306-01 642 533 (16x)  70-31306-10 642 533 			71-34294-00 646 196  71-34274-00 58 50 624  71-34281-00 850 510 			70-31414-10 			81-27295-00 646 274 26x42 AB SL RD FPM  81-24908-10 614 203 80x98 A SL LD FPM 20DS3826  81-39433-00 56 14 844 80x98,39 A LD PTFE 20DS3827→  81-24909-10 56 36 970 35x48 A SL RD MVQ 	2x
1,4	Z 14 XEL Z 14 XEP	55-66 kW (75-90 PS)	ASTRA G ASTRA H ASTRA H LPG ASTRA V ASTRAVAN COMBO COMBO II CORSA C CORSA D CORSA III CORSA III LPG CORSAVAN II MERIVA MERIVA LPG TIGRA	07/00			02-36225-01 16 06 247 			08-34166-01 16 06 596 		71-33492-00 638 133 			61-36225-00 56 07 837 0,32 mm MLS 61-36225-10 0,57 mm MLS 			14-32132-02 56 07 937 (12x) 			15-35888-01 56 07 467 +56 07 987 (13x)  71-35888-00 56 07 467 			12-34223-02 642 500 (16x)  70-34223-00 642 500 			71-36203-00 58 50 796  71-34157-00 850 673  71-36304-00 849 541 			71-34166-00 652 616 			81-33489-10 20 91 167 42x55 RD FPM  81-24908-10 614 203 80x98 A SL LD FPM 				























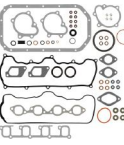
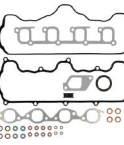









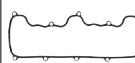















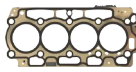

PEL/VAUXHALL

<p>Ltr.   </p>											
<p>1,5 B 15 SFL B 15 SFT D 15 SFL D 15 SFT D 15 XHT</p> <p>103-121 kW INSIGNIA (140-165 PS) Turbo</p> <p>03/17</p>	<p>02-10180-03 12 664 831 +12 662 184</p> 	<p>08-10180-03</p> 	<p>04-10338-01 </p> 	<p>61-10180-00 12 663 440 MLS</p> 	<p>14-10015-01 11 548 125 (10X)</p> 	<p>15-10043-01</p> 	<p>12-10011-01 12 661 724 (8X)</p> 	<p>71-12158-00 </p> <p>12 637 018</p>  <p>71-12187-00 </p> <p>12 657 786</p>	<p>70-31414-10</p> 	<p>81-10458-00 K </p> <p>12 661 527 44x60 A SL FPM</p>  <p>81-10457-00 K </p> <p>12 653 685 84x100 A SL LD FPM</p>  <p>81-10459-00 N</p> <p>12 638 690 37x54 FPM</p> 	
<p>1,5 B 15 XFL B 15 XFT B 15 XHL B 15 XHT</p> <p>103-121 kW (140-165 PS)</p>	<p>02-10180-03 12 664 831 +12 662 184</p> 	<p>08-10180-03</p> 	<p>04-10338-01 </p> 	<p>61-10180-00 12 663 440 MLS</p> 	<p>14-10015-01 11 548 125 (10X)</p> 	<p>15-10043-01</p> 	<p>12-10011-01 12 661 724 (8X)</p> 	<p>71-12158-00 </p> <p>12 637 018</p>  <p>71-12187-00 </p> <p>12 657 786</p>	<p>70-31414-10</p> 	<p>81-10458-00 K </p> <p>12 661 527 44x60 A SL FPM</p>  <p>81-10457-00 K </p> <p>12 653 685 84x100 A SL LD FPM</p>  <p>81-10459-00 N</p> <p>12 638 690 37x54 FPM</p> 	

OPEL/VAUXHALL													
1,5	D 15 DT (DV5RCF) D 15 DT (DV5RD) D 15 DTL (DVSRE)	56-75 kW (76-102 PS)	06/18										
	COMBO COMBO D CORSA F CORSA V CROSSLAND CROSSLAND Turbo CROSSLAND TURBO GRANDLAND Turbo												
				02-10750-02 	08-10147-01 		61-10750-00 35 53 643 76,3 Ø 1,25 mm MLS 	14-32336-01 36 42 418 (10X) 	15-11035-01 U 35 56 974 	12-17500-01 35 53 627 (16X) 	71-17331-00 39 175 855 	70-31414-10 	81-10552-00 K 35 56 990 38x55 A SL RD PTFE 81-38532-00 K 35 56 991 85x105 A SL LD PTFE (Polytetrafluorethylen)/ACM (Polyacryl-Kautschuk) 81-10578-00 N 35 57 000 24,7x47 A SL RD PTFE
1,5	D 15 DT (DV5RUCD) D 15 DTH (DV5RC) D 15 DTH (DV5RUC) F 15 DT (DV5RCE) F 15 DTH (DV5RC) YHY (DV5RCF) YHZ (DV5RC)	75-96 kW (102-131 PS)	04/18 [NEW]										
	ASTRA ASTRA L COMBO COMBO D CORSA F CROSSLAND CROSSLAND Turbo CROSSLAND TURBO CROSSLAND X GRANDLAND GRANDLAND Turbo MOKKA VIVARO CDTI ZAFIRA												
				02-10750-02 	08-10147-01 	04-10380-01 U 	61-10750-00 35 53 643 76,3 Ø 1,25 mm MLS 	14-32336-01 36 42 418 (10X) 	15-11035-01 U 35 56 974 	12-17500-01 35 53 627 (16X) 	71-17331-00 39 175 855 	70-31414-10 	81-10552-00 K 35 56 990 38x55 A SL RD PTFE 81-38532-00 K 35 56 991 85x105 A SL LD PTFE (Polytetrafluorethylen)/ACM (Polyacryl-Kautschuk) 81-10578-00 N 35 57 000 24,7x47 A SL RD PTFE

OPEL/VAUXHALL															
1.5	D 15 DVC D 15 DVH F 15 DVC F 15 DVH	77-90 kW (105-122 PS)	ASTRA K ASTRA K CRDI ASTRA VII CRDI INSIGNIA INSIGNIA B CDTI	08/19 [NEW]		02-11145-01	08-10162-01			14-18424-01 55 490 324 (8X)	15-18425-01 55 496 242	12-18427-01 55 484 799 (12X)	11-18431-01	70-31414-10	81-10610-00 K↔ 55 486 383 Gummi/Metall
												70-18427-00 55 484 799	71-15004-00 39 194 791	81-10611-00 K↔ 55 488 200 Gummi/Metall	
1.5	X 15 D X 15 DT (T4EC1) 15 D 15 DT (T4EC1)	37-49 kW (50-67 PS)	CORSA A D CORSA B D CORSA D CORSAVAN NOVA D NOVA TD NOVAVAN D	06/87	01-52717-01	02-52717-01			61-53100-00 607 974 77,5 Ø 1,4 mm MLS ↔ 178581	14-32160-01 607 939 (10x)	71-53083-00 607 629 ↔ 804794	12-53067-01 642 531 (8x)	71-53003-00 58 50 621	71-53002-00 652 596	81-53267-00 K↔ 614 822 40x52 A SL RD NBR
									61-53100-10 607 034 77,5 Ø 1,45 mm MLS ↔ 178581	1	71-52717-00 607 631 ↔ 804795→	70-53067-00 642 531	71-53004-00 850 602	81-53299-00 K↔ 614 825 87x100 A SL LD FPM	
									61-53100-20 607 975 77,5 Ø 1,5 mm MLS ↔ 178581	2		8x	81-53267-00 N 614 822 40x52 A SL RD NBR		
1.5	X 15 DT X 15 TD 15 DT	49 kW (67 PS)	CORSA A TD CORSA B D CORSA B TD CORSA TD	10/87-09/00	01-52717-01	02-52717-01	04-10004-01		61-53100-00 607 974 77,5 Ø 1,4 mm MLS ↔ 178581	14-32160-01 607 939 (10x)	71-53083-00 607 629 ↔ 804794	12-53067-01 642 531 (8x)	71-53003-00 58 50 621	71-53002-00 652 596	81-53267-00 K↔ 614 822 40x52 A SL RD NBR
									61-53100-10 607 034 77,5 Ø 1,45 mm MLS ↔ 178581	1	71-52717-00 607 631 ↔ 804795→	70-53067-00 642 531	71-53004-00 850 602	81-53299-00 K↔ 614 825 87x100 A SL LD FPM	
									61-53100-20 607 975 77,5 Ø 1,5 mm MLS ↔ 178581	2		8x	81-53267-00 N 614 822 40x52 A SL RD NBR		

OPEL/VAUXHALL

<p>Ltr. </p>	<p>1,5 15 TD</p> <p>53 kW (72 PS)</p> <p>KADETT E TD</p> <p>07/88-08/91</p> <p>1</p>											
<p>01-52717-01</p> 	<p>02-52717-01</p> 	<p>04-10147-01 </p> 	<p>61-53100-00</p> <p>607 974 77,5 Ø 1,4 mm MLS  178581</p> <p>61-53100-10</p> <p>607 034 77,5 Ø 1,45 mm MLS  178581</p> <p>61-53100-20</p> <p>607 975 77,5 Ø 1,5 mm MLS  178581</p> 	<p>14-32160-01</p> <p>607 939 (10x)</p> 	<p>71-53083-00</p> <p>607 629  804794</p>  <p>71-52717-00</p> <p>607 631  804795→</p> 	<p>12-53067-01</p> <p>642 531 (8x)</p>  <p>70-53067-00</p> <p>642 531</p> 	<p>71-53003-00 </p> <p>58 50 621</p>  <p>71-53004-00 </p> <p>850 602</p> 	<p>71-53002-00</p> <p>652 596</p> 	<p>81-53267-00 </p> <p>614 822 40x52 A SL RD NBR</p>  <p>81-53299-00 </p> <p>614 825 87x100 A SL LD FPM</p>  <p>81-53267-00 N</p> <p>614 822 40x52 A SL RD NBR</p> 			
<p>1,6 A 16 DT (DV6D) B 16 DT (DV6DTEd)</p> <p>68 kW (92 PS)</p> <p>COMBO CROSSLAND Turbo</p> <p>07/19</p>	<p>02-40903-02</p> 	<p>08-42514-01</p> 	<p>04-10340-01 </p> 	<p>61-10039-00</p> <p>36 46 404 76 Ø 1,25 mm MLS</p> <p>61-10039-10</p> <p>36 464 05 76 Ø 1,3 mm MLS</p> <p>61-10039-20</p> <p>36 45 892 76 Ø 1,35 mm MLS</p> <p>61-10039-30</p> <p>36 46 406 76 Ø 1,4 mm MLS</p> <p>61-10039-40</p> <p>36 464 07 76 Ø 1,45 mm MLS</p> 	<p>14-32336-01</p> <p>36 42 418 (10x)</p> 	<p>71-40903-00</p> <p>36 45 913</p> 	<p>12-35548-01</p> <p>3642383 (8x)</p>  <p>70-35548-00</p> <p>3642383</p> 	<p>71-39037-00 </p> <p>36 48 032</p> 	<p>70-31414-10</p> 	<p>81-35554-00 </p> <p>36 46 416 40x55 A SL RD PTFE ACM</p>  <p>81-35553-00 </p> <p>36 46 415 85x105 A SL LD PTFE ACM</p>  <p>81-35552-00 N</p> <p>36 46 411 27x47 A SL RD PTFE ACM</p> 		

OPEL/VAUXHALL

Ltr.														
1,6	A 16 DTH B 16 DTC B 16 DTE B 16 DTH B 16 DTJ B 16 DTL B 16 DTN B 16 DTU D 16 DTE D 16 DTH D 16 DTI D 16 DTJ D 16 DTN	70-100 kW (95-136 PS)	02/13	01-10009-01 	02-10017-01 	08-10029-01 		61-42760-00 55 590 777 81 Ø 1,25 mm MLS 61-42760-10 55 590 776 81 Ø 1,35 mm MLS 61-42760-20 55 590 778 81 Ø 1,45 mm MLS 	14-11649-01 55 598 493 (10X) 	71-42951-00 55 571 587 	12-42873-01 642 085 (16x) 70-42873-00 642 085 	71-42856-00 850 767 71-12190-00 55 488 719 	70-31414-10 	81-42879-00 55 585 100 53x72 Gummi 81-10396-00 55 571 582 92x109 LD Gummi
1,6	A 16 FDH A 16 FDL	66-88 kW (90-120 PS)	11/11		02-42061-02 95 512 441 	08-36278-03 95 512 439 		61-38200-00 55 221 093 80,5 Ø 0,82 mm MLS 61-38200-10 55 221 094 80,5 Ø 0,92 mm MLS 61-38200-20 55 221 095 80,5 Ø 1,02 mm MLS 	14-32363-01 55 214 378 (10X) 	71-42061-00 93 191 332 	12-38209-02 642 697 (16x) 70-38209-00 642 697 16x 	11-40692-01 850 336 71-39352-00 93 192 536 71-42073-00 55 206 838 	70-31414-10 	81-35882-00 56 46 262 31x41 AB SL RD FPM 81-90027-00 614 965 93 Ø 81-36229-00 56 36 817 30x45 AB SL RD FPM























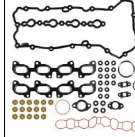

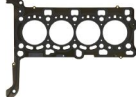
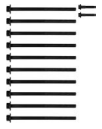

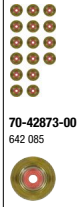







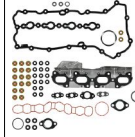

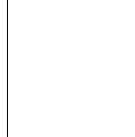
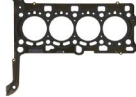
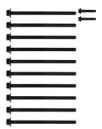









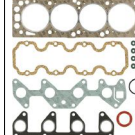



OPEL/VAUXHALL														
1,6	A 16 LEL A 16 LER A 16 LES A 16 LET A 16 XNT B 16 LER B 16 LES B 16 XNT Z 16 LEL Z 16 LER Z 16 LET Z 16 XNT	110-155 kW (150-211 PS)	ASTRA H Turbo ASTRA IV Turbo ASTRA J Turbo ASTRA J Turbo ASTRA Turbo ASTRA V ASTRA V TURBO ASTRA VI ASTRA VI Turbo CORSA D CORSA D Turbo CORSA E Turbo CORSA III CORSA III Turbo CORSA IV Turbo CORSA VI INSIGNIA Turbo MERIVA Turbo MERIVA TURBO ZAFIRA CNG ZAFIRA CNG Turbo ZAFIRA III CNG	08/04										
				02-37240-02 16 29 141	08-38431-01 16 06 536	71-36609-00 24 405 911	61-37240-00 56 07 895 82 Ø 0,65 mm MLS	14-32103-01 90 412 701 (10x)	71-38166-00 56 07 980	12-36613-01 642 002 (16x)	71-38149-00 58 50 534	70-31414-10 	81-35147-00 646 299 31,5x42 AB SL RD FPM 81-38236-00 614 135 80x98 A LD PTFE ACM 81-24909-10 56 36 970 35x48 A SL RD MVQ 	
1,6	A 16 NHT (EP6FDT) A 16 NHT (EP6FDTM)	115-121 kW (156-165 PS)	GRANDLAND Turbo	10/17	02-38010-04 	08-10148-01 	04-10230-01 	61-38010-00 36 48 903 78 Ø 0,9 mm MLS 61-38010-10 78 Ø 1,3 mm MLS 	14-32347-01 0204.C1 	15-12291-01 35 57 978 	12-37621-01 35 56 077 	11-37616-01 35 57 946 	70-31414-10 	81-41219-00 36 39 588 61x75 A SL RD PTFE (Polytetrafluorethylen)/ACM (Polyacryl-Kautschuk) 81-38532-00 35 56 991 85x105 A SL LD PTFE (Polytetrafluorethylen)/ACM (Polyacryl-Kautschuk)
1,6	A 16 SHT A 16 XHT B 16 SHL B 16 SHT D 16 SHJ D 16 SHL D 16 SHT	100-147 kW (136-200 PS)	ASTRA ASTRA J SIDI ASTRA K ASTRA VI SIDI ASTRA VII Turbo CASCADA CASCADA CDTI INSIGNIA INSIGNIA SIDI INSIGNIA Turbo ZAFIRA ZAFIRA C SIDI ZAFIRA III SIDI ZAFIRA SIDI	06/12	02-37480-01 16 29 092	08-37480-01 16 29 093	61-37480-00 55 569 188 80,6 Ø 0,6 mm MLS 	14-11650-01 55 569 189 (10X) 	71-10165-00 636 311 	12-10012-01 55 478 004 (8X) 	71-42949-00 55 569 383 	70-31414-10 	81-42878-00 55 564 508 42x55 RD Gummi 81-42861-00 55 576 715 84x98 ACM 	

OPEL/VAUXHALL														
1.6	A 16 XER B 16 XER D 16 XER Z 16 XER	85 kW (115-116 PS)	ASTRA ASTRA H ASTRA H LPG ASTRA IV Turbo ASTRA J ASTRA V ASTRA VI INSIGNIA INSIGNIA Turbo MOKKA STRA TwinTop ZAFIRA ZAFIRA II	01/04										
1.6	A 16 XHL (EP6FDTMD)	110 kW (150 PS)	GRANDLAND Turbo	12/19										
					<p>02-37240-03 66 06 019</p>	<p>08-38431-01 16 06 536</p>	<p>71-36609-00 </p> <p>24 405 911</p>	<p>61-37240-00 56 07 895 82 Ø 0,65 mm MLS</p>	<p>14-32103-01 90 412 701 (10x)</p>	<p>71-38166-00 56 07 980</p>	<p>12-36613-01 642 002 (16x)</p> <p>70-36613-00 24 405 819</p> <p>16x</p>	<p>71-38218-00 </p> <p>850 948</p> <p>71-38158-00 </p> <p>849 533</p>	<p>70-31414-10</p>	<p>81-35147-00 </p> <p>646 299 31,5x42 AB SL RD FPM</p> <p>81-38236-00 </p> <p>614 135 80x98 A LD PTFE ACM</p> <p>81-24909-10 </p> <p>56 36 970 35x48 A SL RD MVQ</p> <p>2x</p>
					<p>02-38010-06</p>	<p>08-10148-01</p>	<p>04-10230-01 </p>	<p>61-38010-00 36 48 903 78 Ø 0,9 mm MLS</p> <p>61-38010-10 78 Ø 1,3 mm MLS</p>	<p>14-32347-01 0204.C1</p>	<p>15-12291-01 35 57 978</p>	<p>12-37621-01 35 56 077</p> <p>70-37621-00</p> <p>16x</p>	<p>11-37616-01 </p> <p>35 57 946</p> <p>71-12290-00 </p>	<p>70-31414-10</p>	<p>81-41219-00 </p> <p>36 39 588 61x75 A SL RD PTFE (Polytetrafluorethylen)/ACM (Polyacryl-Kautschuk)</p> <p>81-38532-00 </p> <p>35 56 991 85x105 A SL LD PTFE (Polytetrafluorethylen)/ACM (Polyacryl-Kautschuk)</p>

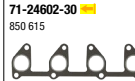























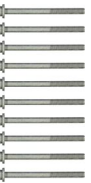







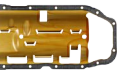





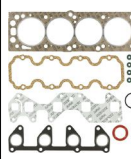









OPEL/VAUXHALL

OPEL/VAUXHALL														
Ltr.														
1,6 B 16 DT (DV6FD) B 16 DTH (DV6FC) B 16 DTL (DV6FE)	55-88 kW (75-120 PS) COMBO D CROSSLAND Turbo CROSSLAND TURBO GRANDLAND Turbo	03/17 [NEW]												
				02-40903-02 	08-42514-01 	04-10383-01	61-10039-00 36 46 404 76 Ø 1,25 mm MLS 	14-32336-01 36 42 418 (10X) 	71-40903-00 36 45 913 	12-35548-01 3642383 (8X) 	71-39037-00	70-31414-10 	81-35554-00	
							61-10039-10 36 464 05 76 Ø 1,3 mm MLS 				70-35548-00 3642383 8x 			81-35553-00
							61-10039-20 36 45 892 76 Ø 1,35 mm MLS 							81-35552-00
							61-10039-30 36 46 406 76 Ø 1,4 mm MLS 							81-35551-00
							61-10039-40 36 464 07 76 Ø 1,45 mm MLS 							81-35550-00
1,6 B 16 DTH	100 kW (136 PS) MERIVA II CDTI	08/13		01-10009-01 	02-10017-01 	08-10029-01 	61-42760-00 55 590 777 81 Ø 1,25 mm MLS 	14-11649-01 55 598 493 (10X) 	71-42951-00 55 571 587 	12-42873-01 642 085 (16x) 	71-42856-00	70-31414-10 	81-10396-00	
							61-42760-10 55 590 776 81 Ø 1,35 mm MLS 				71-12190-00 55 488 719 			81-42879-00
							61-42760-20 55 590 778 81 Ø 1,45 mm MLS 							81-42878-00



























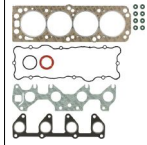



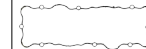

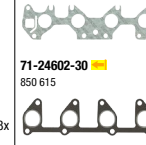





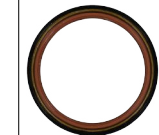



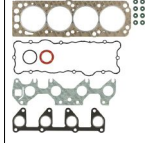

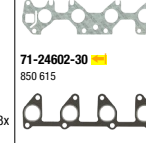

OPEL/VAUXHALL

<p>Ltr. </p>	<p>1,6 B 16 DTR</p>	<p>118 kW (160 PS)</p>	<p>ASTRA K CDTI ASTRA VII CDTI</p>	<p>11/15 </p>											
<p>1,6 B 16 DTR</p>	<p>81 kW (110 PS)</p>	<p>MOKKA CDTI</p>	<p>06/15</p>	<p>02-42760-01 55 590 777 81 Ø 1,25 mm MLS</p> 	<p>08-42760-01 55 590 776 81 Ø 1,35 mm MLS</p> 	<p>61-42760-00 55 590 777 81 Ø 1,25 mm MLS</p> <p>61-42760-10 55 590 776 81 Ø 1,35 mm MLS</p> <p>61-42760-20 55 590 778 81 Ø 1,45 mm MLS</p> 	<p>14-11649-01 55 598 493 (10X)</p> 	<p>71-42951-00 55 571 587</p> 	<p>12-42873-01 642 085 (16x)</p> <p>70-42873-00 642 085</p> 	<p>71-42856-00 </p> <p>850 767</p> <p>11-12186-01 </p> 	<p>70-31414-10</p> 	<p>81-42879-00 </p> <p>55 585 100 53x72 Gummi</p>  <p>81-10396-00 </p> <p>55 571 582 92x109 LD Gummi</p> 			
<p>1,6 B 16 DTU</p>	<p>81 kW (110 PS)</p>	<p>MOKKA CDTI</p>	<p>06/15</p>	<p>01-10009-01</p> 	<p>02-10017-01</p> 	<p>08-10029-01</p> 	<p>61-42760-00 55 590 777 81 Ø 1,25 mm MLS</p> <p>61-42760-10 55 590 776 81 Ø 1,35 mm MLS</p> <p>61-42760-20 55 590 778 81 Ø 1,45 mm MLS</p> 	<p>14-11649-01 55 598 493 (10X)</p> 	<p>71-42951-00 55 571 587</p> 	<p>12-42873-01 642 085 (16x)</p> <p>70-42873-00 642 085</p> 	<p>71-42856-00 </p> <p>850 767</p> <p>71-12190-00 </p> <p>55 488 719</p> 	<p>70-31414-10</p> 	<p>81-42879-00 </p> <p>55 585 100 53x72 Gummi</p>  <p>81-10396-00 </p> <p>55 571 582 92x109 LD Gummi</p> 		
<p>1,6 C 16 LZ</p>	<p>55 kW (75 PS)</p>	<p>ASCONA C KADETT E</p>	<p>09/86-02/93</p>	<p>02-27270-05 16 06 672 +642 527 (8x)</p> 	<p>08-12996-08 16 06 686</p> 	<p>61-27270-20 56 07 408 80,5 Ø 1,3 mm</p> 	<p>14-32102-01 607 242 (10x)</p> 	<p>71-13043-00 638 727</p> 	<p>12-26546-01 642 527 (8x)</p> <p>70-26546-00 642 527</p> 	<p>71-27291-10 </p> <p>850 717</p> <p>71-24602-30 </p> <p>850 615</p> 	<p>71-12996-10 2x 652 611</p> 	<p>81-27295-00 </p> <p>646 274 28x42 AB SL RD FPM</p>  <p>81-24908-10 </p> <p>614 203 80x98 A SL LD FPM</p>  <p>81-24909-10 N</p> <p>56 36 970 35x48 A SL RD MVQ</p> 			





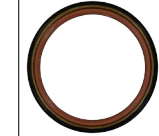



















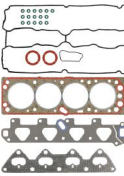



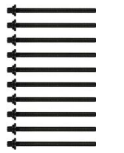
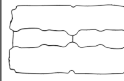
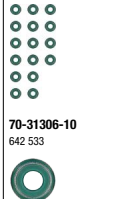

















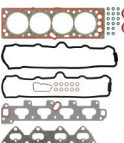



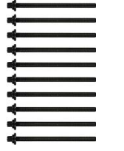

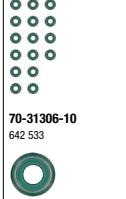
OPEL/VAUXHALL

Ltr.  											
1,6 C 16 LZ2 C 16 NZ2 51-55 kW (69-75 PS) VECTRA A 09/88-11/95					61-34215-00 608 808 82 Ø 1,3 mm 	14-32037-01 607 685 (10x) 	71-13045-30 638 192 	12-26546-01 642 527 (8x)  70-26546-00 642 527 	71-27289-10  850 600  71-25513-10  850 645 8x 	71-31965-00 652 274 	81-25516-10  646 265 31x50 A SL RD FPM  81-38229-00  614 827 90x104 A SL LD  81-24909-10 N 56 36 970 35x48 A SL RD MVQ 
1,6 C 16 NZ E 16 NZ 55-65 kW (75-88 PS) ASCONA C ASTRA F ASTRA III ASTRAMAX CAVALIER III CORSA A KADETT E VECTRA A 09/86-12/98		02-27270-06 16 06 689 +642 527 (8x) 	08-12996-08 16 06 686 		61-27270-20 56 07 408 80,5 Ø 1,3 mm 	14-32102-01 607 242 (10x) 	71-13043-00 638 727 	12-26546-01 642 527 (8x)  70-26546-00 642 527 	71-28182-10  850 522  71-24602-30  850 615 8x  71-25866-10   854 946 	71-12996-10 2x 652 611 	81-27295-00  646 274 26x42 AB SL RD FPM  81-24908-10  614 203 80x98 A SL LD FPM  81-24909-10 N 56 36 970 35x48 A SL RD MVQ 

OPEL/VAUXHALL

Ltr. 	1,6 C 16 SE	74 kW (100-101 PS)	 ASTRA F ASTRA III	 03/91-02/98											
	1,6 C 16 SE	74 kW (100-101 PS)	 ASTRA F ASTRA III	 03/91-02/98	<p>02-27270-08 16 06 729 +642 527 (8x)</p> 	<p>08-12996-05 16 06 728</p> 		<p>61-27270-20 56 07 408 80,5 Ø 1,3 mm</p> 	<p>14-32102-01 607 242 (10x)</p> 	<p>71-29303-00 638 260</p> 	<p>12-26546-01 642 527 (8x)</p> 	<p>71-29302-00 </p> <p>850 607</p>  <p>71-24602-30 </p> <p>850 615</p> <p>8x </p>	<p>71-12996-10 2x</p> <p>652 611</p> 	<p>81-27295-00 </p> <p>646 274 26x42 AB SL RD FPM</p>  <p>81-24908-10 </p> <p>614 203 80x98 A SL LD FPM</p>  <p>81-24909-10 N</p> <p>56 36 970 35x48 A SL RD MVQ</p> 	
	1,6 C 16 SE	74 kW (101 PS)	 CORSA A NOVA	 02/92-03/93	<p>02-27270-08 16 06 729 +642 527 (8x)</p> 	<p>08-12996-08 16 06 686</p> 		<p>61-27270-20 56 07 408 80,5 Ø 1,3 mm</p> 	<p>14-32102-01 607 242 (10x)</p> 	<p>71-29303-00 638 260</p> 	<p>12-26546-01 642 527 (8x)</p> 	<p>71-29302-00 </p> <p>850 607</p>  <p>71-24602-30 </p> <p>850 615</p> <p>8x </p>	<p>71-12996-10 2x</p> <p>652 611</p> 	<p>81-27295-00 </p> <p>646 274 26x42 AB SL RD FPM</p>  <p>81-24908-10 </p> <p>614 203 80x98 A SL LD FPM</p>  <p>81-24909-10 N</p> <p>56 36 970 35x48 A SL RD MVQ</p> 	

OPEL/VAUXHALL

Ltr. 													
1,6 C 16 SEL	74 kW (100-101 PS) ASTRA G CORSA B CORSA C TIGRA	08/97-01/05		<p>02-31995-04 16 06 380</p> 	<p>08-31226-01 16 06 790</p> 		<p>61-31995-10 607 491 80,5 Ø 1,3 mm</p> 	<p>14-32103-01 90 412 701 (10x)</p> 	<p>71-34288-00 638 742</p> 	<p>12-31306-01 642 533 (16x)</p> 	<p>71-34294-00  </p> <p>849 196</p>  <p>71-34274-00  </p> <p>58 50 624</p>  <p>71-31969-00 </p> <p>58 50 613</p>  <p>71-25865-00  </p> <p>854 933</p> 	<p>71-31226-00 652 669</p> 	<p>81-27295-00 </p> <p>646 274 26x42 AB SL RD FPM</p>  <p>81-24908-10 </p> <p>614 203 80x98 A SL LD FPM</p>  <p>81-24909-10 N 2x</p> <p>56 36 970 35x48 A SL RD MVQ</p> 
1,6 C 16 XE	80 kW (109 PS) CORSA CORSA B	03/93-09/00		<p>02-31995-03 16 06 762 +642 533 (16x)</p> 	<p>08-31226-01 16 06 790</p> 		<p>61-31995-10 607 491 80,5 Ø 1,3 mm</p> 	<p>14-32103-01 90 412 701 (10x)</p> 	<p>15-31973-01 638 736 +638 737</p> 	<p>12-31306-01 642 533 (16x)</p> 	<p>71-31966-10 </p> <p>850 668</p>  <p>71-31969-00 </p> <p>58 50 613</p> 	<p>71-31226-00 652 669</p> 	<p>81-27295-00 </p> <p>646 274 26x42 AB SL RD FPM</p>  <p>81-24908-10 </p> <p>614 203 80x98 A SL LD FPM</p>  <p>81-24909-10 N</p> <p>56 36 970 35x48 A SL RD MVQ</p> 

OPEL/VAUXHALL													
1,6	D 16 DTR	110 kW (150 PS)	ASTRA K Turbo ASTRA VII Turbo	08/18									
					02-42760-01 55 590 777 81 Ø 1,25 mm MLS	08-42760-01 55 590 776 81 Ø 1,35 mm MLS	61-42760-00 55 590 777 81 Ø 1,25 mm MLS 61-42760-10 55 590 776 81 Ø 1,35 mm MLS 61-42760-20 55 590 778 81 Ø 1,45 mm MLS	14-11649-01 55 598 493 (10x)	71-42951-00 55 571 587	12-42873-01 642 085 (16x)	71-42856-00 850 767 11-12186-01	70-31414-10	81-42879-00 55 585 100 53x72 Gummi 81-10396-00 55 571 582 92x109 LD Gummi
1,6	D 16 XHT (EP6FADTXD) D 16 XHT (EP6FADTXHP) DGX (EP6FADTXHPE) DGY (EP6FADTXHPD) DGZ (EP6FADTXHP) F 16 XHR (EP6FADTXD)	132-221 kW (180-300 PS)	ASTRA ASTRA L GRANDLAND Turbo	09/18									
					02-38010-05 36 48 903 78 Ø 0,9 mm MLS	08-10148-01 36 48 903 78 Ø 0,9 mm MLS	04-10230-01 36 48 903 78 Ø 0,9 mm MLS	14-32347-01 0204.C1	15-11519-01	12-37621-01 35 56 077	11-37616-01 35 57 946 11-17489-01	70-31414-10	81-41219-00 36 39 588 61x75 A SL RD PTFE (Polytetrafluorethylen)/ACM (Polyacryl-Kautschuk) 81-38532-00 35 56 991 85x105 A SL LD PTFE (Polytetrafluorethylen)/ACM (Polyacryl-Kautschuk)
1,6	E 16 SE 16 SV	60-75 kW (82-102 PS)	ASCONA C ASTRA II ASTRAMAX CAVALIER III CORSA A KADETT E NOVA VECTRA A VECTRA B	09/84-08/96									
					02-27270-04 16 06 673 +642 527 (8x)	08-12996-08 16 06 686	61-27270-20 56 07 408 80,5 Ø 1,3 mm	14-32102-01 607 242 (10x)	71-13043-00 638 727	12-26546-01 642 527 (8x)	71-28182-10 850 522 71-24602-30 850 615 70-26546-00 642 527	71-12996-10 652 611	81-27295-00 646 274 26x42 AB SL RD FPM 81-24908-10 614 203 80x98 A SL LD FPM 81-24909-10 56 36 970 35x48 A SL RD MVQ

OPEL/VAUXHALL

















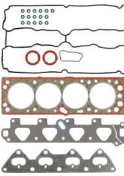





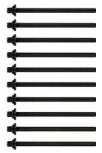

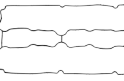



















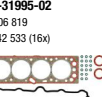
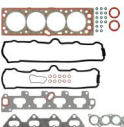



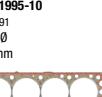

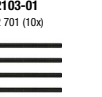

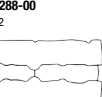
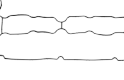
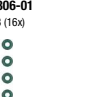

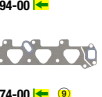









OPEL/VAUXHALL														
Ltr.														
1,6 R9M 408 R9M 413 R9M 415	66-89 kW (90-121 PS) VIVARO CDTI	05/14 [NEW]												
			02-10136-02 44 07 958	08-10136-02 44 07 960	04-10353-01	61-10136-00 44 23 059 81 Ø 1,6 mm MLS	14-11002-01 44 23 061	15-10051-01 95 518 032	12-33512-02 44 23 068(8X)	71-10776-00 44 23 083	70-31414-10 	71-41659-00 44 23 371	70-31414-10 	81-38518-00 93 161 608 50x81 RD PTFE ACM 81-10484-00 44 07 978 96x108 LD FPM
1,6 R9M 450 R9M 452	85-107 kW (116-146 PS) VIVARO CDTI	06/14												
			02-10136-01 44 07 961	08-10136-02 44 07 960		61-10136-00 44 23 059 81 Ø 1,6 mm MLS	14-11002-01 44 23 061	15-10051-01 95 518 032	12-33512-02 44 23 068(8X)	71-10776-00 44 23 083	70-31414-10 	71-41659-00 44 23 371	70-31414-10 	81-38518-00 93 161 608 50x81 RD PTFE ACM 81-10484-00 44 07 978 96x108 LD FPM
1,6 R9M 450 R9M 452	88-107 kW (120-145 PS) VIVARO CDTI	05/14												
			02-10136-01 44 07 961	08-10136-02 44 07 960		61-10136-00 44 23 059 81 Ø 1,6 mm MLS	14-11002-01 44 23 061	15-10051-01 95 518 032	12-33512-02 44 23 068(8X)	71-10776-00 44 23 083	70-31414-10 	71-41659-00 44 23 371	70-31414-10 	81-38518-00 93 161 608 50x81 RD PTFE ACM 81-10484-00 44 07 978 96x108 LD FPM

OPEL/VAUXHALL

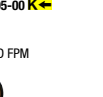
Ltr.	Power	Models	Year	Image 1	Image 2	Image 3	Image 4	Image 5	Image 6	Image 7	Image 8	Image 9	Image 10	Image 11
1,6 X 16 SZ	52 kW (71 PS)	ASTRA F ASTRA III CAVALIER III VECTRA A	02/93-02/98											
					02-2720-06 16 06 689 +642 527 (8x)	08-12996-05 16 06 728		61-27270-20 56 07 408 80,5 Ø 1,3 mm	14-32102-01 607 242 (10x)	71-13043-00 638 727	12-26546-01 642 527 (8x)	71-28182-10 850 522	71-12996-10 652 611	81-27295-00 646 274 26x42 AB SL RD FPM
					 						 70-26546-00 642 527	 71-24602-30 850 615		 81-24908-10 614 203 80x98 A SL LD FPM
														 81-24909-10 N 56 36 970 35x48 A SL RD MVQ
1,6 X 16 SZR 16 NZR	55 kW (75 PS)	ASTRA F ASTRA G ASTRA G LPG ASTRA III ASTRA IV ASTRAN IV KADETT CC VECTRA VECTRA B	09/91-01/05											
					02-2720-06 16 06 689 +642 527 (8x) 02DV7850	08-12996-05 16 06 728		61-27270-20 56 07 408 80,5 Ø 1,3 mm	14-32102-01 607 242 (10x)	71-13043-00 638 727 02DV7850	12-26546-01 642 527 (8x)	71-28182-10 850 522	71-12996-10 652 611	81-27295-00 646 274 26x42 AB SL RD FPM
					 08-31226-01 16 06 790	 08-31226-01 16 06 790				 71-29303-00 638 260 02DV7851 →	 70-26546-00 642 527	 71-24602-30 850 615	 71-31226-00 652 669	 81-24908-10 614 203 80x98 A SL LD FPM
														 81-24909-10 N 56 36 970 35x48 A SL RD MVQ













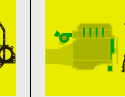

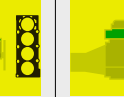
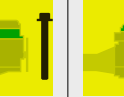
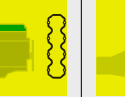

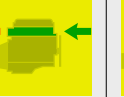

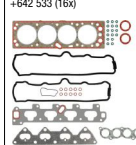
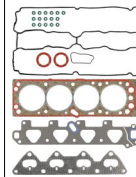

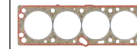
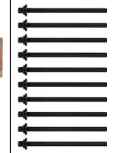
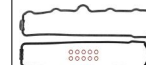
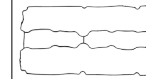









OPEL/VAUXHALL																	
1.6 X 16 XE	78 kW (106 PS)	CORSA CORSA B TIGRA	1	07/94-12/00		02-31995-01 16 06 820 +636 841 (2x) +642 533 (16x)	08-31226-01 16 06 790 		61-31995-10 607 491 80,5 Ø 1,3 mm 	14-32103-01 90 412 701 (10x) 	15-31973-01 638 736 +638 737 	12-31306-01 642 533 (16x) 	71-31966-10 850 668 	71-31226-00 652 669 	81-27295-00 646 274 26x42 AB SL RD FPM 	81-24908-10 614 203 80x98 A SL LD FPM 	81-24909-10 N 2x 56 36 970 35x48 A SL RD MVQ
1.6 X 16 XEL	74 kW (100-101 PS)	ASTRA F ASTRA F ASTRA III VECTRA VECTRA B	W1285446, W5276825, W7154258	01/94-01/05		02-31995-02 16 06 819 +642 533 (16x)	08-31226-01 16 06 790 		61-31995-10 607 491 80,5 Ø 1,3 mm 	14-32103-01 90 412 701 (10x) 	15-31973-01 638 736 +638 737 	12-31306-01 642 533 (16x) 	71-31966-10 850 668 	71-31226-00 652 669 	81-27295-00 646 274 26x42 AB SL RD FPM 	81-24908-10 614 203 80x98 A SL LD FPM 	81-24909-10 N 2x 56 36 970 35x48 A SL RD MVQ



OPEL/VAUXHALL











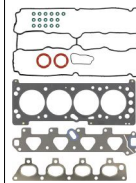

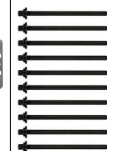
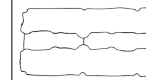
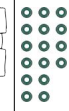



<p>Ltr.  1,6 X 16 XEL</p> <p>74 kW (100-101 PS)</p> <p>ASTRA G ASTRA G LPG ASTRA IV VECTRA VECTRA B ZAFIRA ZAFIRA LPG</p> <p> W1285447, W7154259→</p> <p> W1285447, W7154259→</p> <p> 08/95-08/05</p>		 <p>02-31995-04 16 06 380</p> 	 <p>08-31226-01 16 06 790</p> 		 <p>61-31995-10 607 491 80,5 Ø 1,3 mm</p> 	 <p>14-32103-01 90 412 701 (10x)</p> 	 <p>71-34288-00 638 742</p> 	 <p>12-31306-01 642 533 (16x)</p>  <p>16x</p>	 <p>71-34294-00 </p> <p>849 196</p>  <p>71-34274-00  </p> <p>58 50 624</p>  <p>71-31969-00 </p> <p>58 50 613</p> 	 <p>71-31226-00 652 669</p> 	 <p>81-27295-00 </p> <p>646 274 26x42 AB SL RD FPM</p>  <p>81-24908-10 </p> <p>614 203 80x98 A SL LD FPM</p>  <p>81-24909-10 N 2x</p> <p>56 36 970 35x48 A SL RD MVQ</p> 
<p>1,6 X 16 XEL</p> <p>74 kW (101 PS)</p> <p>ASTRA G</p> <p>02/98-01/05</p>		 <p>02-31995-02 16 06 819 +642 533 (16x)</p> 	 <p>08-31226-01 16 06 790</p> 		 <p>61-31995-10 607 491 80,5 Ø 1,3 mm</p> 	 <p>14-32103-01 90 412 701 (10x)</p> 	 <p>71-34288-00 638 742</p> 	 <p>12-31306-01 642 533 (16x)</p>  <p>16x</p>	 <p>71-34294-00 </p> <p>849 196</p>  <p>71-34274-00  </p> <p>58 50 624</p>  <p>71-31969-00 </p> <p>58 50 613</p>  <p>71-25865-00  </p> <p>854 933</p> 	 <p>71-31414-10</p>  <p>71-31226-00 652 669</p> 	 <p>81-27295-00 </p> <p>646 274 26x42 AB SL RD FPM</p>  <p>81-24908-10 </p> <p>614 203 80x98 A SL LD FPM</p>  <p>81-24909-10 N 2x</p> <p>56 36 970 35x48 A SL RD MVQ</p> 

OPEL/VAUXHALL

Ltr.  1,6 X 16 XEL  74 kW (101 PS) ASTRA IV  09/99-08/04



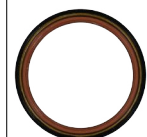













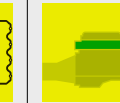
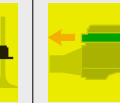
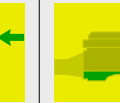
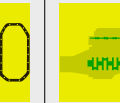
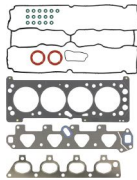



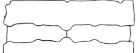





											
	<p>02-31995-02 16 06 819 +642 533 (16x)</p>  <p>02-31995-04 16 06 380</p> 	<p>08-31226-01 16 06 790</p> 		<p>61-31995-10 607 491 80,5 Ø 1,3 mm</p> 	<p>14-32103-01 90 412 701 (10x)</p> 	<p>15-31973-01 638 736 +638 737</p>  <p>71-34288-00 638 742</p> 	<p>12-31306-01 642 533 (16x)</p>  <p>70-31306-10 642 533</p> 	<p>71-31966-10 </p> <p>850 668</p>  <p>71-34294-00 </p> <p>849 196</p>  <p>71-31964-10  </p> <p>58 50 611</p>  <p>71-34274-00  </p> <p>58 50 624</p>  <p>71-31969-00 </p> <p>58 50 613</p> 	<p>71-31226-00 652 669</p> 	<p>81-27295-00 </p> <p>646 274 26x42 AB SL RD FPM</p>  <p>81-24908-10 </p> <p>614 203 80x98 A SL LD FPM</p>  <p>81-24909-10 N 2x</p> <p>56 36 970 35x48 A SL RD MVQ</p> 	

1,6 Y 16 XE  74 kW (100-101 PS) VECTRA  08/95-10/01











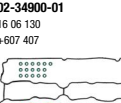

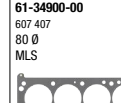
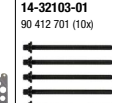
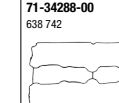
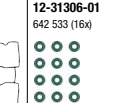
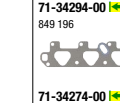

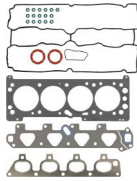



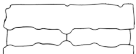





	<p>02-34900-01 16 06 130 +607 407</p> 	<p>08-31226-01 16 06 790</p> 		<p>61-34900-00 607 407 80 Ø MLS</p> 	<p>14-32103-01 90 412 701 (10x)</p> 	<p>71-34288-00 638 742</p> 	<p>12-31306-01 642 533 (16x)</p>  <p>70-31306-10 642 533</p> 	<p>71-34294-00 </p> <p>849 196</p>  <p>71-34274-00  </p> <p>58 50 624</p>  <p>71-34281-00 </p> <p>850 510</p> 	<p>71-31226-00 652 669</p> 	<p>81-27295-00 </p> <p>646 274 26x42 AB SL RD FPM</p>  <p>81-24908-10 </p> <p>614 203 80x98 A SL LD FPM</p>  <p>81-24909-10 N 2x</p> <p>56 36 970 35x48 A SL RD MVQ</p> 
--	--	--	--	--	--	---	---	--	---	--

OPEL/VAUXHALL

























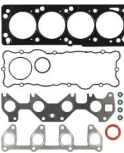



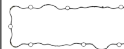









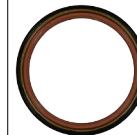

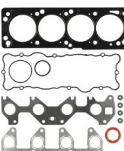





Ltr.  1,6 Y 16 XE 74 kW VECTRA B  10/95-07/02

										
	<p>02-34900-01 16 06 130 +607 407</p> 	<p>08-31226-01 16 06 790</p> 		<p>61-34900-00 607 407 80 Ø MLS</p> 	<p>14-32103-01 90 412 701 (10x)</p> 	<p>71-34288-00 638 742</p> 	<p>12-31306-01 642 533 (16x)</p> 	<p>71-34294-00  </p> <p>646 274</p>  <p>71-34274-00  </p> <p>58 50 624</p>  <p>71-34281-00 </p> <p>850 510</p> 	<p>71-31226-00 652 669</p> 	<p>81-27295-00 </p> <p>646 274 26x42 AB SL RD FPM</p>  <p>81-24908-10 </p> <p>614 203 80x98 A SL LD FPM</p>  <p>81-24909-10  2x</p> <p>56 36 970 35x48 A SL RD MVQ</p> 

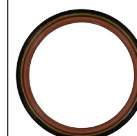

1,6 Y 16 YNG 69 kW (94 PS) COMBO CNG ZAFIRA CNG 07/05-04/15

										
	<p>02-34900-01 16 06 130 +607 407</p> 	<p>08-35564-03</p> 		<p>61-34900-00 607 407 80 Ø MLS</p> 	<p>14-32103-01 90 412 701 (10x)</p> 	<p>71-34288-00 638 742</p> 	<p>12-31306-01 642 533 (16x)</p> 	<p>71-34294-00  </p> <p>646 274</p>  <p>71-34274-00  </p> <p>58 50 624</p>  <p>71-34281-00 </p> <p>850 510</p> 	<p>71-31226-00 652 669</p> 	<p>81-27295-00 </p> <p>646 274 26x42 AB SL RD FPM</p>  <p>81-39433-00 </p> <p>56 14 844 80x98,39 A LD PTFE</p>  <p>81-24909-10  2x</p> <p>56 36 970 35x48 A SL RD MVQ</p> 





















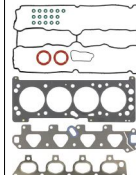



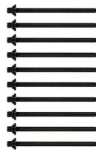
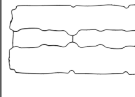
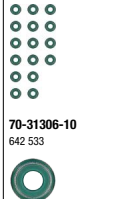

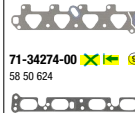





OPEL/VAUXHALL

Ltr. 													
1,6 Z 16 SE	62-69 kW (84-94 PS) ASTRA G ASTRA G LPG ASTRA IV ASTRAVAN IV COMBO COMBO II CORSA B CORSA C MERIVA	03/98		02-34335-01 16 06 095	08-35564-01 16 06 170 		61-34335-00 56 07 864 80 Ø MLS 	14-32102-01 607 242 (10x) 	71-29303-00 638 260 	12-26546-01 642 527 (8x) 	71-34326-00  850 521  71-34334-00  849 518 8x 	70-31414-10 	81-27295-00  646 274 26x42 AB SL RD FPM  81-24908-10  614 203 80x98 A SL LD FPM  81-24909-10 N 56 36 970 35x48 A SL RD MVQ 
1,6 Z 16 SE	63 kW (85 PS) ASTRA IV	03/98-04/04		02-34335-01 16 06 095	08-35564-01 16 06 170  		61-34335-00 56 07 864 80 Ø MLS 	14-32102-01 607 242 (10x) 	71-29303-00 638 260 	12-26546-01 642 527 (8x) 	71-34326-00  850 521  71-34334-00  849 518 8x 	70-31414-10 	81-27295-00  646 274 26x42 AB SL RD FPM  81-24908-10  614 203 80x98 A SL LD FPM  81-24909-10 N 2x 56 36 970 35x48 A SL RD MVQ  81-24909-10 N 56 36 970 35x48 A SL RD MVQ 

OPEL/VAUXHALL





















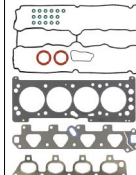



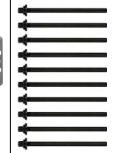
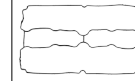











Ltr.  1,6 Z 16 XE  74 kW (100-101 PS)  08/95-08/08

ASTRA G
ASTRA G LPG
ASTRA IV
ASTRAVAN IV
MERIVA
VECTRA
VECTRA B
VECTRA C
ZAFIRA

										
	<p>02-34900-01 16 06 130 +607 407</p> 	<p>08-35564-01 16 06 170 ➡ 20DS3627</p>  <p>08-35564-03 ➡ 20DS3628➔</p> 		<p>61-34900-00 607 407 80 0 MLS</p> 	<p>14-32103-01 90 412 701 (10x)</p> 	<p>71-34288-00 638 742</p> 	<p>12-31306-01 642 533 (16x)</p>  <p>70-31306-10 642 533</p> 	<p>71-34294-00 </p> <p>649 196</p>  <p>71-34274-00  </p> <p>58 50 624</p>  <p>71-34281-00 </p> <p>850 510</p> 	<p>70-31414-10</p>  <p>71-31226-00 652 669</p> 	<p>81-27295-00 </p> <p>646 274 26x42 AB SL RD FPM</p>  <p>81-24908-10 </p> <p>614 203 80x98 A SL LD FPM ➡ 20DS3628➔</p>  <p>81-39433-00 </p> <p>56 14 844 80x98,39 A LD PTFE ➡ 20DS3628➔</p>  <p>81-24909-10  N</p> <p>56 36 970 35x48 A SL RD MVQ</p> 

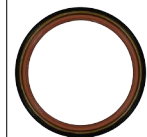
OPEL/VAUXHALL

Ltr.  1,6 Z 16 XE 74 kW (101 PS) ASTRA G  02/98-01/05  1

										
	<p>02-34900-01 16 06 130 +607 407</p> 	<p>08-35564-01 16 06 170 ➔ 20DS3627</p>  <p>08-35564-03 ➔ 20DS3628➔</p> 		<p>61-34900-00 607 407 80 0 MLS</p> 	<p>14-32103-01 90 412 701 (10x)</p> 	<p>71-34288-00 638 742</p> 	<p>12-31306-01 642 533 (16x)</p>  <p>70-31306-10 642 533</p> 	<p>71-34294-00 </p> <p>849 196</p>  <p>71-34274-00  </p> <p>58 50 624</p>  <p>71-34281-00 </p> <p>850 510</p>  <p>71-25865-00  </p> <p>854 933</p> 	<p>70-31414-10</p>  <p>71-31226-00 652 669</p> 	<p>81-27295-00 </p> <p>646 274 26x42 AB SL RD FPM</p>  <p>81-24908-10 </p> <p>614 203 80x98 A SL LD FPM ➔ 20DS3627</p>  <p>81-39433-00 </p> <p>56 14 844 80x98,39 A LD PTFE ➔ 20DS3628➔</p>  <p>81-24909-10  N</p> <p>56 36 970 35x48 A SL RD MVQ</p> 





















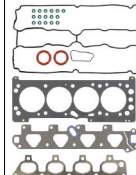
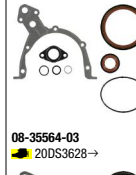

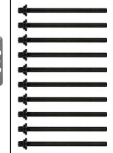
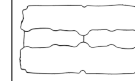
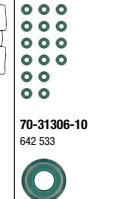

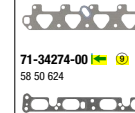



OPEL/VAUXHALL

Ltr.  1,6 Z 16 XE

74-76 kW (101-103 PS)

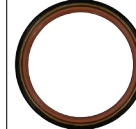
ASTRA G
ASTRA IV
ZAFIRA
ZAFIRA LPG

09/98-01/08 

										
	<p>02-34900-01 16 06 130 +607 407</p> 	<p>08-35564-01 16 06 170 ➡ 20DS3627</p>  <p>08-35564-03 ➡ 20DS3628→</p> 		<p>61-34900-00 607 407 80 0 MLS</p> 	<p>14-32103-01 90 412 701 (10x)</p> 	<p>71-34288-00 638 742</p> 	<p>12-31306-01 642 533 (16x)</p>  <p>70-31306-10 642 533</p> 	<p>71-34294-00 </p> <p>649 196</p>  <p>71-34274-00  </p> <p>58 50 624</p>  <p>71-34281-00 </p> <p>850 510</p> 	<p>70-31414-10</p>  <p>71-31226-00 652 669</p> 	<p>81-27295-00 </p> <p>646 274 26x42 AB SL RD FPM</p>  <p>81-24908-10 </p> <p>614 203 80x98 A SL LD FPM ➡ 20DS3627</p>  <p>81-39433-00 </p> <p>56 14 844 80x98,39 A LD PTFE ➡ 20DS3628→</p>  <p>81-24909-10  N</p> <p>56 36 970 35x48 A SL RD MVQ</p> 

OPEL/VAUXHALL

Ltr.	Z	KW	PS	Model	Date	Image 1	Image 2	Image 3	Image 4	Image 5	Image 6	Image 7	Image 8	Image 9	Image 10	Image 11	Image 12	
1,6	Z 16 XEP	76-77	(103-105)	ASTRA G ASTRA G LPG ASTRA H ASTRA IV ASTRA TwinTop ASTRA V ASTRAVAN IV ASTRAVAN V MERIVA VECTRA C ZAFIRA ZAFIRA II ZAFIRA LPG	03/00													
1,6	Z 16 XER	85 kW (116)	PS	ASTRA H	01/09													
1,6	Z 16 XEP	76-77	(103-105)	ASTRA G ASTRA G LPG ASTRA H ASTRA IV ASTRA TwinTop ASTRA V ASTRAVAN IV ASTRAVAN V MERIVA VECTRA C ZAFIRA ZAFIRA II ZAFIRA LPG	03/00													
1,6	Z 16 XER	85 kW (116)	PS	ASTRA H	01/09													

02-36025-01
16 06 221

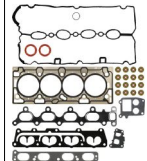

08-36993-01
16 06 222
20DS3627



08-36993-03
16 06 222
20DS3628



71-36609-00
24 405 911

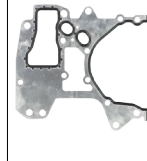

61-36025-00
56 07 863
MLS

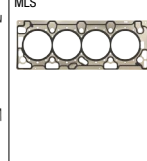

14-32103-01
90 412 701 (10x)

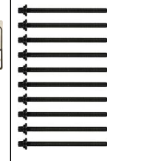

71-36612-00
56 07 593

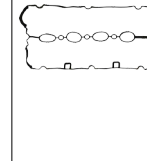

12-36613-01
642 002 (16x)

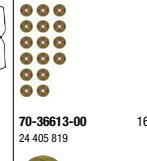

71-36608-00
58 50 667

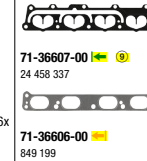

71-36607-00
24 458 337



71-36606-00
849 199



70-31414-10



81-35147-00
646 299
31,5x42
AB SL RD FPM

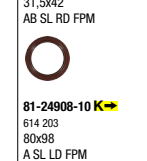

81-24908-10
614 203
80x98
A SL LD FPM
20DS3627

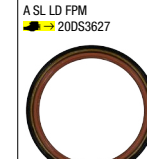

81-39433-00
56 14 844
80x98,39
A LD PTFE
20DS3628



81-24909-10
56 36 970
35x48
A SL RD MVQ

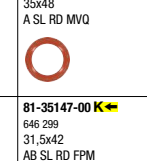

02-37240-03
66 06 019

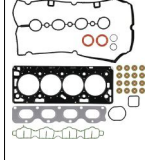

08-38431-01
16 06 536



61-37240-00
56 07 895
82 Ø
0,65 mm
MLS

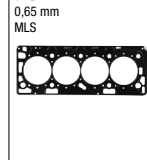

14-32103-01
90 412 701 (10x)

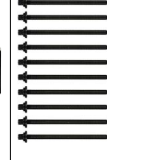

71-38166-00
56 07 980

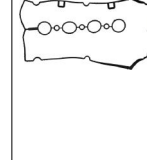

12-36613-01
642 002 (16x)

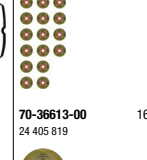

71-38218-00
850 948

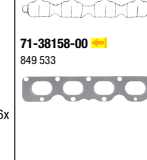

71-38158-00
849 533



70-36613-00
24 405 819



70-31414-10

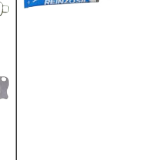

81-35147-00
646 299
31,5x42
AB SL RD FPM



81-38236-00
614 135
80x98
A LD PTFE ACM





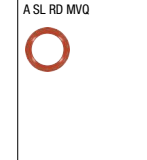















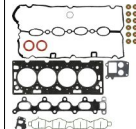



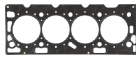
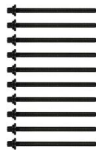
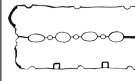
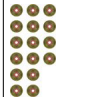



81-24909-10
56 36 970
35x48
A SL RD MVQ











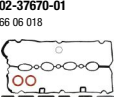

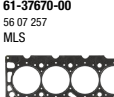
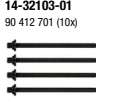

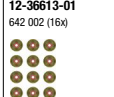
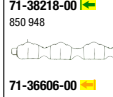







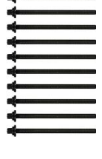
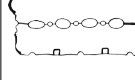





OPEL/VAUXHALL

Ltr.  1,6 Z 16 XE1
 76-77 kW ASTRA V  45-4899999
 (103-105 PS) ASTRAMAN V  45-4899999
 ZAFIRA II  45-4899999
 01/04 

										
	<p>02-37670-01 66 06 018</p> 	<p>08-36993-01 16 06 222</p> 	<p>71-36609-00 </p> <p>24 405 911</p> 	<p>61-37670-00 56 07 257 MLS</p> 	<p>14-32103-01 90 412 701 (10x)</p> 	<p>71-36612-00 56 07 593</p> 	<p>12-36613-01 642 002 (16x)</p>  <p>70-36613-00 24 405 819</p> 	<p>71-38218-00 </p> <p>850 948</p>  <p>71-36606-00 </p> <p>849 199</p> 	<p>70-31414-10</p> 	<p>81-35147-00 </p> <p>646 299 31,5x42 AB SL RD FPM</p>  <p>81-24908-10 </p> <p>614 203 80x98 A SL LD FPM</p>  <p>81-24909-10 </p> <p>56 36 970 35x48 A SL RD MVQ</p> 























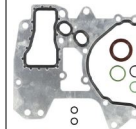

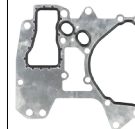
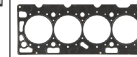
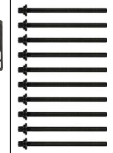
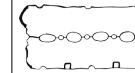





Ltr.  1,6 Z 16 XE1
 76-77 kW ASTRA V  52-5800001→
 (103-105 PS) ASTRAMAN V  52-5800001→
 ZAFIRA II  52-5800001→
 01/04

										
	<p>02-37670-01 66 06 018</p> 	<p>08-36993-03 16 06 222</p> 	<p>71-36609-00 </p> <p>24 405 911</p> 	<p>61-37670-00 56 07 257 MLS</p> 	<p>14-32103-01 90 412 701 (10x)</p> 	<p>71-36612-00 56 07 593</p> 	<p>12-36613-01 642 002 (16x)</p>  <p>70-36613-00 24 405 819</p> 	<p>71-38218-00 </p> <p>850 948</p>  <p>71-36606-00 </p> <p>849 199</p> 	<p>70-31414-10</p> 	<p>81-35147-00 </p> <p>646 299 31,5x42 AB SL RD FPM</p>  <p>81-39433-00 </p> <p>56 14 844 80x98,39 A LD PTFE</p>  <p>81-24909-10 </p> <p>56 36 970 35x48 A SL RD MVQ</p> 

OPEL/VAUXHALL

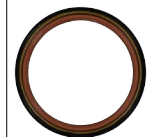

















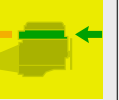





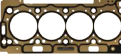







Ltr.  1,6 Z 16 XE1 77 kW (105 PS) ASTRA H ZAFIRA

 03/04-09/12











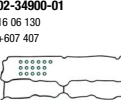

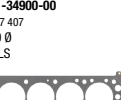
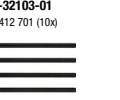
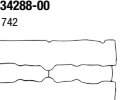
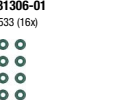
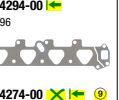

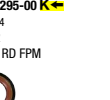
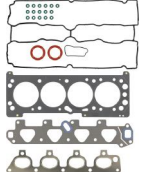









										
	<p>02-37670-01 66 06 018</p> 	<p>08-36993-01 16 06 222 → 45-48999999</p>  	<p>71-36609-00  24 405 911</p> 	<p>61-37670-00 56 07 257 MLS</p> 	<p>14-32103-01 90 412 701 (10x)</p> 	<p>71-36612-00 56 07 593</p> 	<p>12-36613-01 642 002 (16x)</p>  <p>70-36613-00 24 405 819</p> 	<p>71-38218-00  850 948</p>  <p>71-36606-00  849 199</p>  <p>16x</p>	<p>70-31414-10</p>  	<p>81-35147-00  646 299 31,5x42 AB SL RD FPM</p>  <p>81-24908-10  614 203 80x98 A SL LD FPM → 45-48999999</p>  <p>81-39433-00  56 14 844 80x98,39 A LD PTFE → 52-58000001→</p>  <p>81-24909-10  56 36 970 35x48 A SL RD MVQ</p>  <p>2x</p>

OPEL/VAUXHALL

Ltr.  1,6 Z 16 XU (EC5F) 85 kW (116 PS) COMBO  03/21

										
	<p>02-35055-04</p> 	<p>08-38532-02</p> 		<p>61-35055-10 79,8 Ø 0,6 mm MLS</p> <p>61-35055-20  79,8 Ø 0,9 mm MLS</p> 	<p>14-32139-04</p> 	<p>71-42166-00 2x</p> 	<p>12-33512-02 44 23 068(BX)</p>  <p>70-33512-00 642 542</p> 	<p>11-35246-01 </p>  <p>71-35067-00 </p>  <p>71-42093-00  </p> 	<p>70-31414-10</p> 	<p>81-38533-00 </p> <p>42x66 A SL RD PTFE (Polytetrafluorethylen)/ACM (Polyacryl-Kautschuk)</p>  <p>81-38532-00 </p> <p>35 56 991 85x105 A SL LD PTFE (Polytetrafluorethylen)/ACM (Polyacryl-Kautschuk)</p>  <p>81-38531-00 N</p> <p>38x50 A SL RD PTFE (Polytetrafluorethylen)/ACM (Polyacryl-Kautschuk)</p>  <p>81-38657-00 N</p> <p>39x50 A SL RD PTFE (Polytetrafluorethylen)/ACM (Polyacryl-Kautschuk)</p> 

1,6 Z 16 YNG 69-71 kW (94-97 PS) ASTRA G CNG COMBO CNG COMBO II COMBO II CNG ZAFIRA CNG 09/01

										
	<p>02-34900-01 16 06 130 +607 407</p> 	<p>08-35564-03</p> 		<p>61-34900-00 607 407 80 Ø MLS</p> 	<p>14-32103-01 90 412 701 (10x)</p> 	<p>71-34288-00 638 742</p> 	<p>12-31306-01 642 533 (16x)</p>  <p>70-31306-10 642 533</p> 	<p>71-34294-00 </p> <p>849 196</p>  <p>71-34274-00  </p> <p>58 50 624</p>  <p>71-34281-00 </p> <p>850 510</p> 	<p>70-31414-10</p>  <p>71-31226-00 652 669</p> 	<p>81-27295-00 </p> <p>646 274 26x42 AB SL RD FPM</p>  <p>81-39433-00 </p> <p>56 14 844 80x98,39 A LD PTFE</p>  <p>81-24909-10 N 2x</p> <p>56 36 970 35x48 A SL RD MVQ</p> 

OPEL/VAUXHALL

Ltr. 1.6 16 D 40 kW (54 PS) ASCONA C D 03/82-08/88

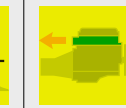

02-13016-01
 14498630

02-13045-01
 14498631 →

02-13045-01
 14503757 →

08-13017-06
 16 06 719
 14498630

08-13017-06
 16 06 719
 14503756

08-13017-05
 16 06 683
 14498631 →

61-25015-30
 607 995
 81,5 Ø
 1,4 mm

61-25015-40
 607 996
 81,5 Ø
 1,5 mm

61-25015-50
 607 997
 81,5 Ø
 1,6 mm



14-32038-01
 607 686 (10x)

14-32038-01
 607 686 (10x)

14-32038-01
 607 686 (10x)

71-13016-00
 638 646
 14498630

71-13016-00
 638 646
 14503756

71-13045-30
 638 192
 14498631 →

12-26545-01
 642 526 (8x)

12-26545-00
 642 526

12-26545-00
 642 526

71-24988-20
 850 616

71-25798-20
 850 608

71-25798-20
 850 608

8x

71-25596-00
 854 929

71-13017-00
 652 586

71-13017-00
 652 586

71-13017-00
 652 586

81-21798-40
 646 290
 35x50
 A SL RD FPM/ACM

81-25517-00
 614 817
 86x104
 A SL LD FPM
 14503756

81-38229-00
 614 827
 90x104
 A SL LD
 14503757 →

81-24909-10
 56 36 970
 35x48
 A SL RD MVQ

OPEL/VAUXHALL

Ltr. 1.6 16 D 40 kW (54 PS) ASTRA II D 09/84-08/91

	<p>02-13016-01 14498630</p> <p>02-13045-01 14498631 →</p>	<p>08-13017-06 16 06 719 14498630</p> <p>08-13017-05 16 06 683 14498631 →</p>		<p>61-25015-30 607 995 81,5 Ø 1,4 mm</p> <p>61-25015-40 607 996 81,5 Ø 1,5 mm</p> <p>61-25015-50 607 997 81,5 Ø 1,6 mm</p>	<p>14-32038-01 607 686 (10x)</p>	<p>71-13016-00 638 646 14498630</p> <p>71-13045-30 638 192 14498631 →</p>	<p>12-26545-01 642 526 (8x)</p> <p>70-26545-00 642 526</p>	<p>71-24988-20 </p> <p>850 616</p> <p>71-25798-20 850 608</p> <p>71-25596-00 </p> <p>854 929</p>	<p>71-13017-00 652 586</p>	<p>81-21798-40 </p> <p>646 290 35x50 A SL RD FPM/ACM</p> <p>81-25517-00 </p> <p>614 817 86x104 A SL LD FPM 14498630 →</p> <p>81-38229-00 </p> <p>614 827 90x104 A SL LD 14498631 →</p> <p>81-24909-10 N</p> <p>56 36 970 35x48 A SL RD MVQ</p>

OPEL/VAUXHALL

Ltr. 1.6 16 D 40 kW (54 PS) **KADETT D D** 03/82-08/84 **1**

	<p>02-13016-01 14498630, 14503756 </p> <p>02-13045-01 14498631, 14503757→ </p>	<p>08-13017-06 16 06 719 14498630, 14503756 </p> <p>08-13017-05 16 06 683 14498631, 14503757→ </p>		<p>61-25015-30 607 995 81,5 Ø 1,4 mm</p> <p>61-25015-40 607 996 81,5 Ø 1,5 mm</p> <p>61-25015-50 607 997 81,5 Ø 1,6 mm</p>	<p>14-32038-01 607 686 (10x)</p>	<p>71-13016-00 638 646 14498630, 14503756 </p> <p>71-13045-30 638 192 14498631, 14503757→ </p>	<p>12-26545-01 642 526 (8x)</p> <p>70-26545-00 642 526</p>	<p>71-24988-20 850 616 </p> <p>71-25798-20 850 608 </p> <p>71-25596-00 854 929 </p>	<p>71-13017-00 652 586</p>	<p>81-21798-40 646 290 35x50 A.SL.RD.FPM/ACM </p> <p>81-25517-00 614 817 86x104 A.SL.LD.FPM 14498630, 14503756</p> <p>81-38229-00 614 827 90x104 A.SL.LD 14498631, 14503757→</p> <p>81-24909-10 56 36 970 35x48 A.SL.RD.MVQ </p>

OPEL/VAUXHALL

Ltr. 1,6 16 D 40 kW (54 PS) KADETT E D 09/84-01/89 1



1,6 16 D 40 kW (54 PS) KADETT E D 09/84-01/89

02-13016-01
14498630

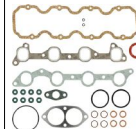

02-13016-01
14498630,
14503756

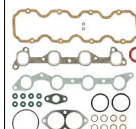

02-13045-01
14498631→

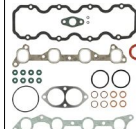

02-13045-01
14498631,
14503757→

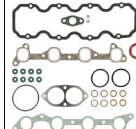

02-13045-01
14503757→

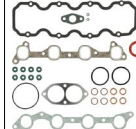

08-13017-06
16 06 719
14498630



08-13017-06
16 06 719
14498630,
14503756

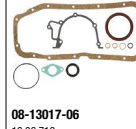

08-13017-06
16 06 719
14503756

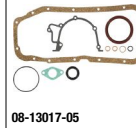

08-13017-05
16 06 683
14498631→

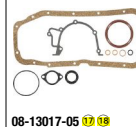

08-13017-05
16 06 683
14498631,
14503757→

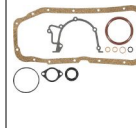

61-25015-30
607 995
81,5 Ø
1,4 mm

61-25015-40
607 996
81,5 Ø
1,5 mm

61-25015-50
607 997
81,5 Ø
1,6 mm



14-32038-01
607 686 (10x)

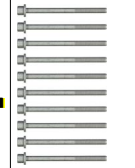

71-13016-00
638 646
14498630,
14503756



71-13016-00
638 646
14503756



71-13045-30
638 192
14498631,
14503757→

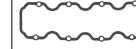

71-13045-30
638 192
14503757→

12-26545-01
642 526 (8x)

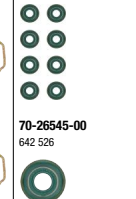

71-13016-00
638 646
14503756



71-13045-30
638 192
14503757→

71-24988-20
850 616



71-25798-20
850 608



71-25596-00
854 929



71-13017-00
652 586



81-21798-40
646 290
35x50
A SL RD FPM/ACM



81-25517-00
614 817
86x104
A SL LD FPM
14498630



81-25517-00
614 817
86x104
A SL LD FPM
14498630,
14503756



81-38229-00
614 827
90x104
A SL LD
14498631→



81-38229-00
614 827
90x104
A SL LD
14498631,
14503757→



81-24909-10 **N**
56 36 970
35x48
A SL RD MVQ



OPEL/VAUXHALL

Ltr.  1,6 16 D
16 DA

40 kW (54 PS)

ASTRA D
ASTRA II D
ASTRA V D
ASTRAMAX D
CAVALIER II
CAVALIER II D
KADETT E D

02/82-08/91 





02-13016-01
14498630 



08-13017-06
16 06 719
14498630 



02-13045-01
14498631 → 



08-13017-05
16 06 683
14498631 → 

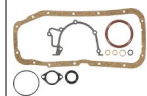

61-25015-30
607 995
81,5 Ø
1,4 mm

61-25015-40
607 996
81,5 Ø
1,5 mm

61-25015-50
607 997
81,5 Ø
1,6 mm



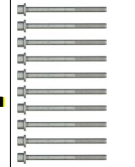

14-32038-01
607 686 (10x)



71-13016-00
638 646
14498630 



71-13045-30
638 192
14498631 → 





12-26545-01
642 526 (8x)





70-26545-00
642 526





71-24988-20 



71-25798-20 



71-25596-00  



71-13017-00
652 586



81-21798-40 



81-25517-00 



81-38229-00 



81-24909-10 



OPEL/VAUXHALL

Ltr. 16 DA 40 kW (54 PS) ASCONA C D 03/82-08/88 1

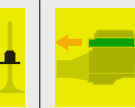
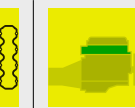
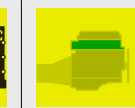

02-13016-01
 14498630

02-13016-01
 14503756

02-13045-01
 14498631→

02-13045-01
 14503757→

08-13017-06
 16 06 719
 14498630

08-13017-06
 16 06 719
 14503756

08-13017-05
 16 06 683
 14498631, 14503757, 4734→

08-13017-05
 16 06 683
 14503757→

61-25015-30
 607 995
 81,5 Ø
 1,4 mm

61-25015-40
 607 996
 81,5 Ø
 1,5 mm

61-25015-50
 607 997
 81,5 Ø
 1,6 mm

14-32038-01
 607 686 (10x)

71-13016-00
 638 646
 14503756

71-13045-30
 638 192
 14498631→

12-26545-01
 642 526 (8x)

70-26545-00
 642 526

71-24988-20

71-25798-20

71-25596-00

71-13017-00
 652 586

81-21798-40

81-25517-00

81-38229-00

81-38229-00

81-24909-10

OPEL/VAUXHALL

Ltr. 1,6 16 DA 40 kW (54 PS) KADETT E D 09/84-01/89

	<p>02-13016-01 </p> <p> 14498630, 14503756</p> <p>02-13016-01</p> <p> 14498630, 14503756, 4734</p> <p>02-13016-01</p> <p> 14503756</p> <p>02-13045-01</p> <p> 14498631→</p> <p>02-13045-01 </p> <p> 14498631, 14503757→</p> <p>02-13045-01 </p> <p> 14498631, 14503757→</p>	<p>08-13017-06</p> <p>16 06 719 14498630</p> <p>08-13017-06 </p> <p>16 06 719 14498630, 14503756</p> <p>08-13017-06</p> <p>16 06 719 14503756</p> <p>08-13017-05</p> <p>16 06 683 14498631→</p> <p>08-13017-05 </p> <p>16 06 683 14498631, 14503757→</p> <p>08-13017-05</p> <p>16 06 683 14503757→</p>		<p>61-25015-30</p> <p>607 995 81,5 Ø 1,4 mm</p> <p>61-25015-40</p> <p>607 996 81,5 Ø 1,5 mm</p> <p>61-25015-50</p> <p>607 997 81,5 Ø 1,6 mm</p>	<p>14-32038-01</p> <p>607 686 (10x)</p>	<p>71-13016-00</p> <p>638 646 14498630</p> <p>71-13016-00 </p> <p>638 646 14498630, 14503756</p> <p>71-13045-30</p> <p>638 192 14498631→</p> <p>71-13045-30 </p> <p>638 192 14498631, 14503757→</p> <p>71-13045-30</p> <p>638 192 14503757→</p>	<p>12-26545-01</p> <p>642 526 (8x)</p> <p>70-26545-00</p> <p>642 526</p>	<p>71-24988-20 </p> <p>850 616</p> <p>71-25798-20 </p> <p>850 608</p> <p>71-25596-00 </p> <p>854 929</p>	<p>71-13017-00</p> <p>652 586</p>	<p>81-21798-40 </p> <p>646 290 35x50 A SL RD FPM/ACM</p> <p>81-25517-00 </p> <p>614 817 86x104 A SL LD FPM 14498630, 14503756</p> <p>81-25517-00 </p> <p>614 817 86x104 A SL LD FPM 14503756</p> <p>81-38229-00 </p> <p>614 827 90x104 A SL LD 14498631→</p> <p>81-38229-00 </p> <p>614 827 90x104 A SL LD 14498631, 14503757→</p> <p>81-24909-10 N</p> <p>56 36 970 35x48 A SL RD MVQ</p>

OPEL/VAUXHALL

Ltr.	Engine	Power	Model	Year	Image 1	Image 2	Image 3	Image 4	Image 5	Image 6	Image 7	Image 8	Image 9	Image 10	Image 11	Image 12
1,6	16 LZ2	55 kW (75 PS)	ASTRA F VECTRA A VECTRA B	09/93-07/03												
									61-34215-00 608 808 82 Ø 1,3 mm 	14-32037-01 607 685 (10x) 	71-13045-30 638 192 	12-26546-01 642 527 (8x) 8x 70-26546-00 642 527 	71-27289-10 850 600 71-25513-10 850 645 	71-13054-10 652 599 	81-25516-10 646 265 31x50 A SL RD FPM 81-38229-00 614 827 90x104 A SL LD 81-24909-10 N 56 36 970 35x48 A SL RD MVQ 	
1,6	16 N 16 N (CIH)	44-50 kW (60-68 PS)	ASCONA A ASCONA B CAVALIER MANTA A MANTA B	09/70-08/81		02-23115-02 16 06 347 +642 530 (4x) 	08-12841-06 16 06 598 +614 815 		61-23115-20 607 477 +638 182 87 Ø 1,3 mm 		71-12944-00 607 664 	12-27431-02 642 452 (4x) +642 530 (4x) 4x 40-77344-00 AS 642 452 4x 70-27431-00 ES 642 530 	71-20654-10 850 619 71-19846-10 854 835 	10-12841-02 16 06 230 	81-19195-00 638 187 45x60 A SL RD ACM 81-20667-30 90 156 857 77x100 A SL LD FPM 	
1,6	16 N 16 SH	55-66 kW (75-90 PS)	ASCONA C ASTRA ASTRA II CAVALIER II KADETT D KADETT E	09/81-08/88		02-25075-03 16 06 670 +642 526 (8x) 	08-13017-04 16 06 678 		61-25075-30 607 992 81,5 Ø 1,3 mm 	14-32037-01 607 685 (10x) 	71-13016-00 638 646 	12-26545-01 642 526 (8x) 8x 70-26545-00 642 526 	71-26007-10 850 719 71-25513-10 850 645 71-25865-00 854 933 	71-13017-00 652 586 	81-25516-10 646 265 31x50 A SL RD FPM 81-25517-00 614 817 86x104 A SL LD FPM 81-24909-10 N 56 36 970 35x48 A SL RD MVQ 	

















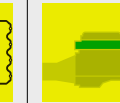
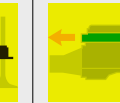
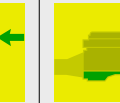
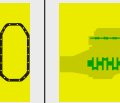





OPEL/VAUXHALL														
1,6	16 S	51-66 kW (69-90 PS)	ASCONA A ASCONA B ASTRA ASTRA II KADETT C MANTA A MANTA B	09/70-08/91	02-23120-02 16 06 348 +642 530 (4x) 	08-12841-06 16 06 598 +614 815 	61-23120-20 607 999 +638 182 87 Ø 1 mm 	71-12944-00 607 664 	12-27431-02 642 452 (4x) +642 530 (4x) 	71-20654-10 850 619 	10-12841-02 16 06 230 	81-19195-00 638 187 45x60 A SL RD ACM 		
					40-77344-00 AS 4x 642 452 	71-19846-10 854 835 	71-23862-10 854 841 	71-27431-00 ES 4x 642 530 	81-20667-30 90 156 857 77x100 A SL LD FPM 					
1,6	16 SV	60 kW (82 PS)	ASTRA II	01/89-12/91	02-27270-04 16 06 673 +642 527 (8x) 	08-12996-08 16 06 686 	61-27270-20 56 07 408 80,5 Ø 1,3 mm 	14-32102-01 607 242 (10x) 	71-13043-00 638 727 	12-26546-01 642 527 (8x) 	71-28182-10 850 522 	71-12996-10 2x 652 611 	81-27295-00 646 274 26x42 AB SL RD FPM 	
					71-24602-30 850 615 	70-26546-00 8x 642 527 	81-24908-10 614 203 80x98 A SL LD FPM 	81-24909-10 N 56 36 970 35x48 A SL RD MVQ 						
1,7	A 17 DT A 17 DTJ A 17 DTL A 17 DTR Z 17 DTJ	74-92 kW (100-125 PS)	ASTRA CDTI ASTRA J ASTRA J CDTI ASTRA V CDTI ASTRA VI CDTI MERIVA B CDTI ZAFIRA CDTI ZAFIRA II TD	02/07-01/17	02-38168-01 	08-38446-01 	04-10306-01 	61-37235-00 56 07 634 0,95 mm MLS 1	14-32290-01 56 07 637 (10x) 	71-38168-00 56 07 252 	12-31306-01 642 533 (16x) 	71-38148-00 58 50 163 	70-31414-10 	81-35144-00 614 804 40x52 A SL RD FPM
					61-37235-10 56 07 635 1 mm MLS 2	61-37235-20 56 07 636 1,05 mm MLS 3	71-38144-00 849 339 	70-31306-10 16x 642 533 	81-53299-00 614 825 87x100 A SL LD FPM 					
					81-28236-00 N 646 269 38x50 A SL RD FPM 									



OPEL/VAUXHALL















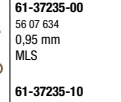
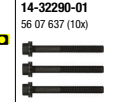
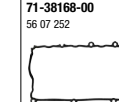
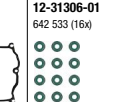
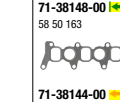
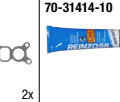





Ltr.														
1,7	A 17 DT A 17 DTL A 17 DTR Z 17 DT Z 17 DTJ Z 17 DTR	74-92 kW (100-125 PS)	09/03											
	ASTRA CDTI ASTRA H CDTI ASTRA S T V CDTI ASTRA VI CDTI CORSA D CDTI CORSA III CDTI MERIVA CDTI MERIVA II CDTI ZAFIRA CDTI			02-38168-01 	08-38446-01 	04-10302-01	61-37235-00 56 07 634 0,95 mm MLS 1	14-32290-01 56 07 637 (10x) 	71-38168-00 56 07 252 	12-31306-01 642 533 (16x) 16x	71-38148-00 58 50 163 71-38144-00 849 339 2x 	70-31414-10 	81-35144-00 K 614 804 40x52 A SL RD FPM 81-53299-00 K 614 825 87x100 A SL LD FPM 81-28236-00 N 646 269 38x50 A SL RD FPM 	
1,7	A 17 DTC A 17 DTE A 17 DTF A 17 DTI A 17 DTN A 17 DTS	74-96 kW (101-131 PS)	03/07				61-37235-00 56 07 634 0,95 mm MLS 1	14-32290-01 56 07 637 (10x) 	71-38168-00 56 07 252 	12-31306-01 642 533 (16x) 16x	71-40673-00 850 118 71-38144-00 849 339 2x 	70-31414-10 	81-35144-00 K 614 804 40x52 A SL RD FPM 81-53299-00 K 614 825 87x100 A SL LD FPM 81-28236-00 N 646 269 38x50 A SL RD FPM 	
	ASTRA CDTI ASTRA IV CDTI ASTRA J ASTRA J CDTI ASTRA VI CDTI ASTRA VI CDTI CORSA D CDTI CORSA III CDTI MERIVA B CDTI MERIVA II CDTI MOKKA CDTI			02-38168-01 	08-38446-01 	04-10302-01	61-37235-10 56 07 635 1 mm MLS 2	61-37235-20 56 07 636 1,05 mm MLS 3						

OPEL/VAUXHALL

Ltr.  1,7 A 17 DTJ 81 kW (110 PS) ASTRA H CDTI  1727137→ 02/07-05/14  1

										
	02-38168-01 614 804 40x52 A SL RD FPM	08-38446-01 614 804 40x52 A SL RD FPM	04-10302-01  61-37235-00 56 07 634 0,95 mm MLS 1  61-37235-10 56 07 635 1 mm MLS 2  04-10306-01  61-37235-20 56 07 636 1,05 mm MLS 3 	14-32290-01 56 07 637 (10x) 1  2  3 	71-38168-00 56 07 252	12-31306-01 642 533 (16x) 16x 70-31306-10 642 533	71-38148-00  58 50 163 71-38144-00  2x 849 339	70-31414-10 	81-35144-00  614 804 40x52 A SL RD FPM 81-53299-00  614 825 87x100 A SL LD FPM 81-28236-00  646 269 38x50 A SL RD FPM 81-28236-00  646 269 38x50 A SL RD FPM	

1,7 A 17 DTJ 81-92 kW (110-125 PS) ASTRA CDTI  1727137→ 01/04-05/14
A 17 DTR (110-125 PS) ASTRA H CDTI  1727137→
ASTRA V  1727137→
CDTI



























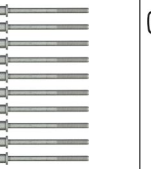
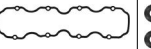
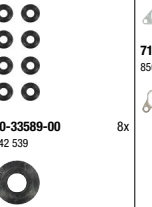







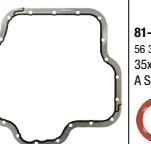













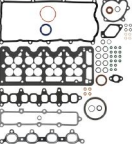
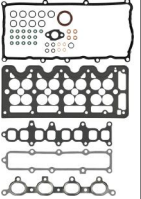

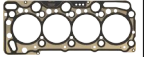

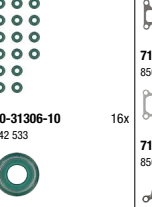











										
	02-38168-01 614 804 40x52 A SL RD FPM	08-38446-01 614 804 40x52 A SL RD FPM	04-10302-01  61-37235-00 56 07 634 0,95 mm MLS 1  61-37235-10 56 07 635 1 mm MLS 2  04-10306-01  61-37235-20 56 07 636 1,05 mm MLS 3 	14-32290-01 56 07 637 (10x) 1  2  3 	71-38168-00 56 07 252	12-31306-01 642 533 (16x) 16x 70-31306-10 642 533	71-38148-00  58 50 163 71-38144-00  2x 849 339	70-31414-10 	81-35144-00  614 804 40x52 A SL RD FPM 81-53299-00  614 825 87x100 A SL LD FPM 81-28236-00  646 269 38x50 A SL RD FPM	

OPEL/VAUXHALL

Ltr.														
1,7	A 17 DTJ A 17 DTR Z 17 DTJ	81-92 kW (110-125 PS)	01/09		<p>02-38168-01</p>	<p>08-38446-01</p>	<p>61-37235-00 56 07 634 0,95 mm MLS</p> <p>61-37235-10 56 07 635 1 mm MLS</p> <p>61-37235-20 56 07 636 1,05 mm MLS</p>	<p>14-32290-01 56 07 637 (10x)</p>	<p>71-38168-00 56 07 252</p>	<p>12-31306-01 642 533 (16x)</p> <p>70-31306-10 642 533</p> <p>16x</p>	<p>71-38148-00 </p> <p>58 50 163</p> <p>71-38144-00 2x</p> <p>849 339</p>	<p>70-31414-10</p>	<p>81-35144-00 </p> <p>614 804 40x52 A SL RD FPM</p> <p>81-53299-00 </p> <p>614 825 87x100 A SL LD FPM</p> <p>81-28236-00 </p> <p>646 269 38x50 A SL RD FPM</p>	
1,7	A 17 DTR	92 kW (125 PS)	01/08-10/15		<p>02-38168-01</p>	<p>08-38446-01</p>	<p>04-10302-01 </p>	<p>61-37235-00 56 07 634 0,95 mm MLS</p> <p>61-37235-10 56 07 635 1 mm MLS</p> <p>61-37235-20 56 07 636 1,05 mm MLS</p>	<p>14-32290-01 56 07 637 (10x)</p>	<p>71-38168-00 56 07 252</p>	<p>12-31306-01 642 533 (16x)</p> <p>70-31306-00 642 533</p> <p>16x</p>	<p>71-38148-00 </p> <p>58 50 163</p> <p>71-38144-00 2x</p> <p>849 339</p>	<p>70-31414-10</p>	<p>81-35144-00 </p> <p>614 804 40x52 A SL RD FPM</p> <p>81-53299-00 </p> <p>614 825 87x100 A SL LD FPM</p> <p>81-28236-00 </p> <p>646 269 38x50 A SL RD FPM</p>

OPEL/VAUXHALL															
1.7	X 17 D X 17 D (4EE1) X 17 DT X 17 DT (TC4EE1) 17 D 17 D (4EE1)	42-60 kW (57-82 PS)	COMBO COMBO D CORSA B D CORSA C D CORSA D CORSAVAN D VECTRA B	01/94											
					01-52717-01 	02-52717-01 			61-52775-00 608 805 80,5 Ø 1,4 mm MLS → 320552 61-52775-10 608 806 80,5 Ø 1,5 mm MLS → 320552 61-52775-20 608 804 80,5 Ø 1,6 mm MLS → 320552 	14-32160-01 607 939 (10x) 	71-52717-00 607 631 	12-53067-01 642 531 (8x) 	71-53003-00 58 50 621 71-53004-00 850 602 	71-53002-00 652 596 	81-53267-00 614 822 40x52 A SL RD NBR 81-53299-00 614 825 87x100 A SL LD FPM 81-53267-00 N 614 822 40x52 A SL RD NBR
1.7	X 17 DT X 17 TD X17TD 17 DT 17 DT (TC4EE1) 17 TD	60 kW (82 PS)	ASTRA F TD ASTRA F TDS ASTRA III TD CAVALIER III TD VECTRA VECTRA A TD VECTRA B TD	09/88-12/98											
					01-52717-01 	02-52717-01 	04-10147-01 	61-52775-00 608 805 80,5 Ø 1,4 mm MLS → 320552 61-52775-10 608 806 80,5 Ø 1,5 mm MLS → 320552 61-52775-20 608 804 80,5 Ø 1,6 mm MLS → 320552 	14-32160-01 607 939 (10x) 	71-52717-00 607 631 	12-53067-01 642 531 (8x) 	71-53003-00 58 50 621 71-53004-00 850 602 	71-53002-00 652 596 	81-53267-00 614 822 40x52 A SL RD NBR 81-53299-00 614 825 87x100 A SL LD FPM 81-53267-00 N 614 822 40x52 A SL RD NBR 	

OPEL/VAUXHALL

<p>Ltr. </p>	<p>1,7 X 17 DTL</p> <p>50 kW (68 PS)</p> <p>ASTRA F TD ASTRA G TD ASTRA III TD ASTRA IV TD</p> <p> 01/94-08/06</p>											
<p>1,7 X 17 DTL</p>	<p>02-33367-01</p> 	<p>08-33408-01 </p>  <p>08-33696-01 16 06 575 +614 840</p>	<p>61-33580-30 56 07 443 84 Ø 1,3 mm MLS</p> <p>61-33580-40 56 07 444 84 Ø 1,4 mm MLS</p> <p>61-33580-50 56 07 445 84 Ø 1,5 mm MLS</p> 	<p>14-32038-01 607 686 (10x)</p> 	<p>71-33367-00 638 733</p> 	<p>12-33589-01 642 539 (8x)</p>  <p>70-33589-00 642 539</p>	<p>71-24988-20 </p> <p>850 616</p>  <p>71-25798-20 </p> <p>850 608</p>  <p>8x</p>	<p>71-33408-00 </p> <p>652 602</p>  <p>71-33696-00 652 608</p>  <p>71-33697-00 </p> <p>652 609</p> 	<p>81-21798-40 </p> <p>646 290 35x50 A SL RD FPM/ACM</p>  <p>81-38229-00 </p> <p>614 827 90x104 A SL LD</p>  <p>81-24909-10 </p> <p>56 36 970 35x48 A SL RD MVQ</p> 	<p>81-35144-00 </p> <p>614 804 40x52 A SL RD FPM</p>  <p>81-53299-00 </p> <p>614 825 87x100 A SL LD FPM</p>  <p>81-28236-00 </p> <p>646 269 38x50 A SL RD FPM</p> 	<p>71-24909-10 </p> <p>56 36 970 35x48 A SL RD MVQ</p> 	
<p>1,7 Y 17 DT Y 17 DTL</p> <p>48-55 kW (65-75 PS)</p> <p>ASTRA G DTI ASTRA IV DTI ASTRAVAN IV DTI COMBO DI COMBO DTI COMBO II DI COMBO II DTI CORSA C D CORSA C DI CORSA C DTI CORSA II DI CORSAVAN II DI</p> <p>02/00</p>	<p>01-53146-01</p> 	<p>02-53146-01</p> 	<p>04-10035-01 </p> 	<p>61-53245-00 56 07 872 80 Ø 1,45 mm MLS</p> <p>61-53245-10 56 07 873 80 Ø 1,5 mm MLS</p> <p>61-53245-20 56 07 874 1,55 mm MLS</p> 	<p>14-32160-01 607 939 (10x)</p> 	<p>71-53146-00 607 492</p> 	<p>12-31306-01 642 533 (16x)</p>  <p>70-31306-10 642 533</p>  <p>16x</p>	<p>71-53143-00 </p> <p>850 675</p>  <p>71-53716-00  </p> <p>850 676</p>  <p>71-53144-00 </p> <p>850 677</p> 	<p>70-31414-10</p> 	<p>81-35144-00 </p> <p>614 804 40x52 A SL RD FPM</p>  <p>81-53299-00 </p> <p>614 825 87x100 A SL LD FPM</p>  <p>81-28236-00 </p> <p>646 269 38x50 A SL RD FPM</p> 	<p>81-35144-00 </p> <p>614 804 40x52 A SL RD FPM</p>  <p>81-53299-00 </p> <p>614 825 87x100 A SL LD FPM</p>  <p>81-28236-00 </p> <p>646 269 38x50 A SL RD FPM</p> 	

OPEL/VAUXHALL														
Ltr.														
1,7 Y 17 DT	55 kW (75 PS) CORSA II DTI CORSAVAN II DTI MERIVA CDTI MERIVA DTI	08/00-06/10	1	01-53146-01 	02-53146-01 			61-53245-00 56 07 872 80 Ø 1,45 mm MLS 1 	14-32160-01 607 939 (10x) 	71-53146-00 607 492 	12-31306-01 642 533 (16x) 	71-53143-00 850 675 71-53716-00 850 676 70-31306-10 16x 642 533 	70-31414-10 	81-35144-00 614 804 40x52 A SL RD FPM 81-53299-00 614 825 87x100 A SL LD FPM 81-28236-00 646 269 38x50 A SL RD FPM
1,7 Z 17 DTH	74 kW (100-101 PS) ASTRA H CDTI ASTRA V CDTI COMBO CDTI COMBO DTI COMBO II CDTI CORSA C CDTI CORSA II CDTI MERIVA CDTI	08/00		02-36081-01 	08-38447-01 	04-10072-01	61-53245-00 56 07 872 80 Ø 1,45 mm MLS 1 	14-32160-01 607 939 (10x) 	71-36081-00 56 07 815 	12-31306-01 642 533 (16x) 	71-35562-00 849 216 71-36303-00 2x 849 530 	70-31414-10 	81-35144-00 614 804 40x52 A SL RD FPM 81-53299-00 614 825 87x100 A SL LD FPM 81-28236-00 646 269 38x50 A SL RD FPM	

OPEL/VAUXHALL



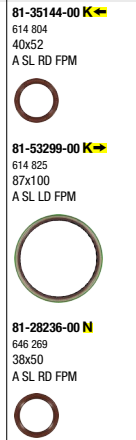
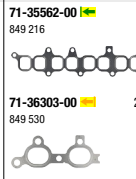
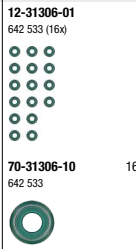
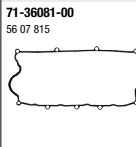
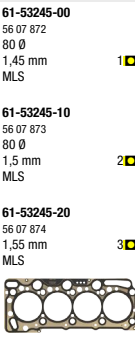
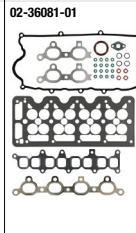



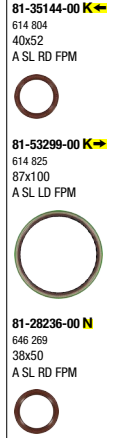
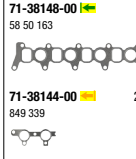
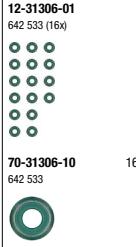
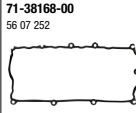
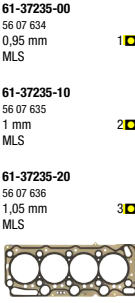
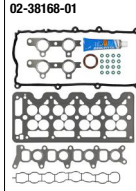









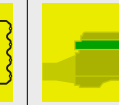
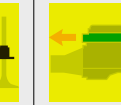
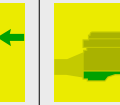





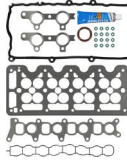



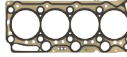

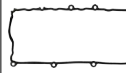

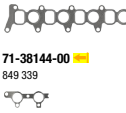











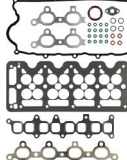



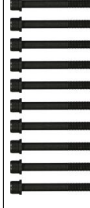

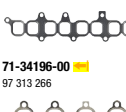

Ltr.  1,7 Z 17 DTH  74 kW (101 PS) ASTRA H CDTI ASTRAMAN V CDTI  03/04-11/11



1,7 Z 17 DTJ 81 kW (110 PS) ASTRA H CDTI 02/07-10/10



























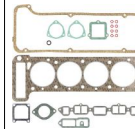
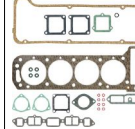
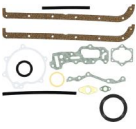

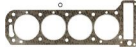



















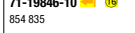











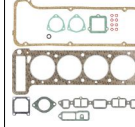
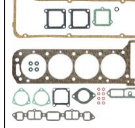
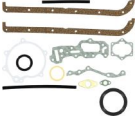
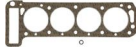



















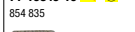

OPEL/VAUXHALL

OPEL/VAUXHALL														
Ltr. 														
1,7 Z 17 DTJ	81 kW (110 PS) ASTRA H CDTI	02/07-05/14		<p>02-38168-01</p> 	<p>08-38446-01</p> 	<p>04-10302-01 </p> 	<p>61-37235-00 56 07 634 0,95 mm MLS</p> <p>61-37235-10 56 07 635 1 mm MLS</p> <p>61-37235-20 56 07 636 1,05 mm MLS</p> 	<p>14-32290-01 56 07 637 (10x)</p> 	<p>71-38168-00 56 07 252</p> 	<p>12-31306-01 642 533 (16x)</p> <p>70-31306-10 642 533</p> 	<p>71-38148-00 </p> <p>58 50 163</p>  <p>71-38144-00 </p> <p>849 339</p> 	<p>70-31414-10</p> 	<p>81-35144-00 </p> <p>614 804 40x52 A SL RD FPM</p>  <p>81-53299-00 </p> <p>614 825 87x100 A SL LD FPM</p>  <p>81-28236-00 </p> <p>646 269 38x50 A SL RD FPM</p>  <p>81-28236-00 </p> <p>646 269 38x50 A SL RD FPM</p> 	
1,7 Z 17 DTL	59 kW (80 PS) ASTRA CDTI ASTRA G CDTI ASTRA H CDTI ASTRA IV CDTI	04/03-10/10		<p>02-36081-01</p> 	<p>08-38447-01</p> 	<p>04-10035-01 </p> 	<p>61-53245-00 56 07 872 80 Ø 1,45 mm MLS</p> <p>61-53245-10 56 07 873 80 Ø 1,5 mm MLS</p> <p>61-53245-20 56 07 874 1,55 mm MLS</p> 	<p>14-32160-01 607 939 (10x)</p> 	<p>71-36081-00 56 07 815</p> 	<p>12-31306-01 642 533 (16x)</p> <p>70-31306-10 642 533</p> 	<p>71-35562-00 </p> <p>849 216</p>  <p>71-34196-00 </p> <p>97 313 266</p> 	<p>70-31414-10</p> 	<p>81-35144-00 </p> <p>614 804 40x52 A SL RD FPM</p>  <p>81-53299-00 </p> <p>614 825 87x100 A SL LD FPM</p>  <p>81-28236-00 </p> <p>646 269 38x50 A SL RD FPM</p> 	

OPEL/VAUXHALL

OPEL/VAUXHALL																					
Ltr.																					
1,7 Z 17 DTL	59 kW (80 PS) ASTRA V CDTI ASTRAVAN V	01/04-05/09	1																		
				02-36081-01 56 07 872 80 Ø 1,45 mm MLS	08-38447-01 614 804 40x52 A SL RD FPM	61-53245-00 56 07 872 80 Ø 1,45 mm MLS	61-53245-10 56 07 873 80 Ø 1,5 mm MLS	61-53245-20 56 07 874 1,55 mm MLS	14-32160-01 607 939 (10x)	71-36081-00 56 07 815	12-31306-01 642 533 (16x)	71-35562-00 849 216	70-31414-10 	81-35144-00 K ↔ 614 804 40x52 A SL RD FPM							
1,7 17 D 17 DR	42-44 kW (57-60 PS) ASTRA F D ASTRA II D ASTRA III ASTRA III D ASTRAMAX CAVALIER III D KADETT E D VECTRA A D	08/88-01/99																			
				02-13045-01 607 464 84 Ø 1,3 mm ↔ 14555259	08-13017-05 16 06 683	61-28130-00 607 464 84 Ø ↔ 14555259	61-28130-10 607 472 84 Ø 1,4 mm ↔ 14555259	61-28130-20 607 466 84 Ø 1,5 mm ↔ 14555259	61-33580-30 56 07 443 84 Ø 1,3 mm MLS ↔ 14555260→	61-33580-40 56 07 444 84 Ø 1,4 mm MLS ↔ 14555260→	61-33580-50 56 07 445 84 Ø 1,5 mm MLS ↔ 14555260→	14-32038-01 607 686 (10x)	71-13045-30 638 192	12-26545-01 642 526 (8x)	71-24998-20 850 616	71-25798-20 850 608	71-25596-00 642 526	71-13017-00 652 586	81-21798-40 K ↔ 646 290 35x50 A SL RD FPM/ACM	81-38229-00 K ↔ 614 827 90x104 A SL LD	81-24909-10 N 56 36 970 35x48 A SL RD MVQ

OPEL/VAUXHALL

Ltr. 													
1,7 17 N	44-49 kW (60-67 PS) REKORD C REKORD D REKORD E	08/66-10/82	 	<p>02-22010-05 16 06 265 ➡ 17 N 251114</p> <p>02-23125-05 16 06 346 +642 530 (4x) ➡ 17 N 256659→</p>	<p>08-12841-06 16 06 598 +614 815</p> 		<p>61-22010-20 607 469 +638 182 95 0 0,75 mm ➡ 17 N 251114</p>  <p>61-23125-20 607 984 +638 182 95 0 0,75 mm ➡ 17 N 256659→</p> 		<p>71-12944-00 607 664 ➡ 17 N 251114</p> 	<p>12-27431-02 642 452 (4x) +642 530 (4x) ➡ 17 N 256659→</p>           <p>40-77344-00 8x 642 452 ➡ 17 N 251114</p>  <p>40-77344-00 AS 4x 642 452 ➡ 17 N 256659→</p>  <p>70-27431-00 ES 4x 642 530 ➡ 17 N 256659→</p>  	<p>71-20654-10    </p> <p>850 619</p>     <p>71-19846-10   </p> <p>854 835</p> 	<p>10-12841-02 16 06 230</p>  	<p>81-19195-00 K </p> <p>638 187 45x60 A SL RD ACM</p>  <p>81-20667-30 K </p> <p>90 156 857 77x100 A SL LD FPM</p> 
1,7 17 N	44-55 kW (60-75 PS) REKORD A REKORD B	03/63-12/66	 	<p>02-22010-05 16 06 265 ➡ 17 N 251114</p> <p>02-23125-05 16 06 346 +642 530 (4x) ➡ 17 N 256659→</p>	<p>08-12841-06 16 06 598 +614 815</p> 		<p>61-22010-20 607 469 +638 182 95 0 0,75 mm ➡ 17 N 251114</p>  <p>61-23125-20 607 984 +638 182 95 0 0,75 mm ➡ 17 N 256659→</p> 		<p>71-12944-00 607 664 ➡ 17 N 256659→ ➡ 17 N 251114</p> 	<p>12-27431-02 642 452 (4x) +642 530 (4x) ➡ 17 N 256659→</p>          <p>40-77344-00 AS 4/8x 642 452 ➡ 17 N 256659→ ➡ 17 N 251114</p>  <p>70-27431-00 ES 4x 642 530 ➡ 17 N 256659→</p>  	<p>71-20654-10    </p> <p>850 619</p>     <p>71-19846-10   </p> <p>854 835</p> 	<p>10-12841-02 16 06 230</p>  	<p>81-19195-00 K </p> <p>638 187 45x60 A SL RD ACM</p>  <p>81-20667-30 K </p> <p>90 156 857 77x100 A SL LD FPM</p> 

OPEL/VAUXHALL

Ltr. 1,7 17 S 55 kW (75 PS) KADETT B 08/67-08/71

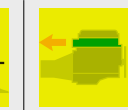

02-22010-05
16 06 265
➔ 17 S 649606

02-23125-05
16 06 346
+642 530 (4x)
➔ 17 S 662312➔

08-12841-06
16 06 598
+614 815

61-22010-20
607 469
+638 182
95 0
0,75 mm
➔ 17 S 649606

61-23125-20
607 984
+638 182
95 0
0,75 mm
➔ 17 S 662312➔

71-12944-00
607 664
➔ 17 S 662312➔
➔ 17 S 649606

12-27431-02
642 452 (4x)
+642 530 (4x)
➔ 17 S 662312➔

71-20654-10
850 619

71-19846-10
854 835

10-12841-02
16 06 230

81-19195-00
638 187
45x60
A SL RD ACM

81-20667-30
90 156 857
77x100
A SL LD FPM

1,7 17 S 55 kW (75 PS) OLYMPIA A 08/67-08/71

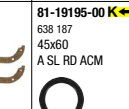
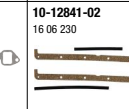
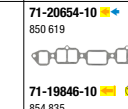
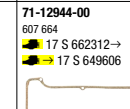
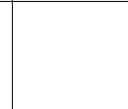
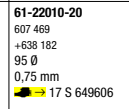
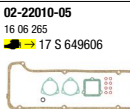

02-22010-05
16 06 265
➔ 17 S 649606

02-23125-05
16 06 346
+642 530 (4x)
➔ 17 S 662312➔

08-12841-06
16 06 598
+614 815

61-22010-20
607 469
+638 182
95 0
0,75 mm
➔ 17 S 649606

61-23125-20
607 984
+638 182
95 0
0,75 mm
➔ 17 S 662312➔

71-12944-00
607 664
➔ 17 S 662312➔
➔ 17 S 649606

12-27431-02
642 452 (4x)
+642 530 (4x)
➔ 17 S 662312➔

71-20654-10
850 619

























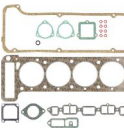
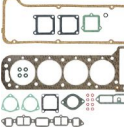

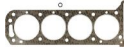















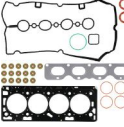



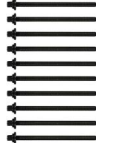
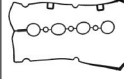

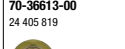

71-19846-10
854 835

10-12841-02
16 06 230

81-19195-00
638 187
45x60
A SL RD ACM

81-20667-30
90 156 857
77x100
A SL LD FPM













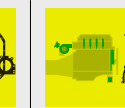

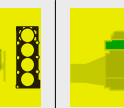

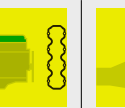
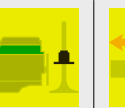
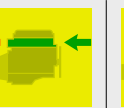

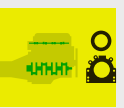
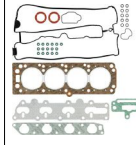



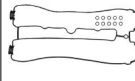

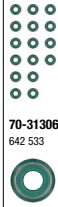













OPEL/VAUXHALL

<p>Ltr.  17 S</p>	<p> 55-61 kW (75-83 PS)</p>	<p> 04/64-02/75</p>											
<p>1,7 17 S</p>	<p>REKORD A REKORD B REKORD C REKORD D</p>	<p>04/64-02/75</p>	<p>02-22010-05 16 06 265 ➔ 17 S 649606</p>  <p>02-23125-05 16 06 346 +642 530 (4x) ➔ 17 S 662312➔</p> 	<p>08-12841-06 16 06 598 +614 815</p> 		<p>61-22010-20 607 469 +638 182 95 Ø 0,75 mm ➔ 17 S 649606</p>  <p>61-23125-20 607 984 +638 182 95 Ø 0,75 mm ➔ 17 S 662312➔</p> 		<p>71-12944-00 607 664 ➔ 17 S 649606</p> 	<p>12-27431-02 642 452 (4x) +642 530 (4x) ➔ 17 S 662312➔</p>  <p>40-77344-00 642 452 ➔ 17 S 649606</p>  <p>40-77344-00 AS 642 452 ➔ 17 S 662312➔</p>  <p>70-27431-00 ES 642 530 ➔ 17 S 662312➔</p> 	<p>71-20654-10  </p> <p>850 619</p>  <p>71-19846-10  </p> <p>854 835</p> 	<p>10-12841-02 16 06 230</p> 	<p>81-19195-00 K </p> <p>638 187 45x60 A SL RD ACM</p>  <p>81-20667-30 K </p> <p>90 156 857 77x100 A SL LD FPM</p> 	
<p>1,8 A 18 XEL A 18 XER B 18 XER Z 18 XER</p>	<p>85-103 kW (115-140 PS) ASTRA ASTRA H ASTRA J ASTRA V INSIGNIA MOKKA SIGNUM VECTRA C VECTRA II ZAFIRA ZAFIRA B ZAFIRA II ZAFIRA III ZAFIRA LPG</p>	<p>01/04</p>	<p>02-37240-01 16 06 537</p> 	<p>08-38431-01 16 06 536</p> 	<p>71-36609-00 </p> <p>24 405 911</p> 	<p>61-37240-00 56 07 895 82 Ø 0,65 mm MLS</p> 	<p>14-32103-01 90 412 701 (10x)</p> 	<p>71-38166-00 56 07 980</p> 	<p>12-36613-01 642 002 (16x)</p>  <p>70-36613-00 24 405 819</p> 	<p>11-38221-01 </p> <p>58 50 345</p>  <p>71-38158-00 </p> <p>849 533</p> 	<p>70-31414-10</p> 	<p>81-35147-00 K </p> <p>646 299 31,5x42 AB SL RD FPM</p>  <p>81-38236-00 K </p> <p>614 135 80x98 A LD PTFE ACM</p>  <p>81-24909-10 N  2x</p> <p>56 36 970 35x48 A SL RD MVQ</p> 	











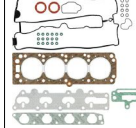

















OPEL/VAUXHALL																
1.8	C 18 NE C 18 NT	66-74 kW (90-100 PS)	ASCONA C ASTRA II CAVALIER II KADETT E		08/84-09/92											
Ltr.						02-27275-04 16 06 682 +642 527 (8x)	08-27293-02 16 06 663		61-27275-10 607 986 86,3 Ø 1,3 mm	14-32037-01 607 685 (10x)	71-13045-30 638 192	12-26546-01 642 527 (8x)	71-26510-10 850 601	71-27293-00 652 587	81-25516-10 646 265 31x50 A SL RD FPM	
																81-38229-00 614 827 90x104 A SL LD
															81-24909-10 N 56 36 970 35x48 A SL RD MVQ	
1.8	C 18 NZ E 18 NV E 18 NVR S 18 NV 18 NV 18 SV	60-74 kW (82-100 PS)	ASCONA C ASTRA F ASTRA III CARLTON III CAVALIER III KADETT CC KADETT E OMEGA A OMEGA B VECTRA A		01/85-07/99	02-27275-03 16 06 666 +642 527 (8x)	08-27293-02 16 06 663		61-27275-10 607 986 86,3 Ø 1,3 mm	14-32037-01 607 685 (10x)	71-13045-30 638 192	12-26546-01 642 527 (8x)	71-27289-10 850 600	71-27293-00 652 587	81-25516-10 646 265 31x50 A SL RD FPM	
																81-38229-00 614 827 90x104 A SL LD
															81-24909-10 N 56 36 970 35x48 A SL RD MVQ	
															81-27317-00 N 636 839 55x70,1 AB LD FPM	

OPEL/VAUXHALL

Ltr.  1.8 C 18 SEL  85 kW (116 PS) ASTRA F  11/94-09/98













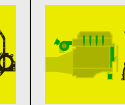
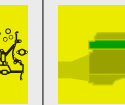
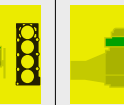

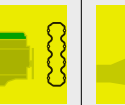
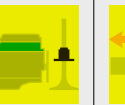
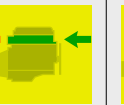

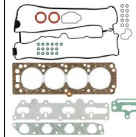



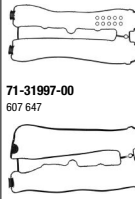







											
	<p>02-33000-02 16 06 914</p> 	<p>08-31965-02  16 06 787</p> 		<p>61-33000-10 608 809 83 Ø 1,3 mm</p> 	<p>14-32104-01 607 256 (10x)</p> 	<p>15-31997-01 607 647 +607 648 (10x)</p>  <p>71-31997-00 607 647</p> 	<p>12-31306-01 642 533 (16x)</p>  <p>70-31306-10 642 533</p> 	<p>71-31976-00  850 655</p>  <p>71-31971-00  850 656</p>  <p>71-25865-00   854 933</p> 	<p>71-31979-00  652 635</p>  <p>71-31978-00   652 636</p> 	<p>81-25516-10   646 265 31x50 A SL RD FPM</p>  <p>81-38229-00   614 827 90x104 A SL LD</p>  <p>81-24909-10   N 2x 56 36 970 35x48 A SL RD MVQ</p>  	

1.8 C 18 XE 85-92 kW ASTRA F
C 18 XEL (115-125 PS) ASTRA III 06/93-03/01











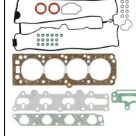

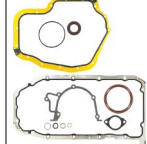

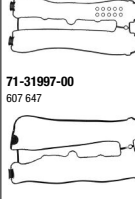
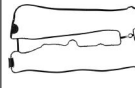









	<p>02-33000-02 16 06 914</p> 	<p>08-31965-01  16 06 834 +646 265</p> 		<p>61-33000-10 608 809 83 Ø 1,3 mm</p> 	<p>14-32104-01 607 256 (10x)</p> 	<p>15-31997-01 607 647 +607 648 (10x)</p>  <p>71-31997-00 607 647</p> 	<p>12-31306-01 642 533 (16x)</p>  <p>70-31306-10 642 533</p> 	<p>71-31976-00  850 655</p>  <p>71-31971-00  850 656</p>  <p>71-25865-00   854 933</p> 	<p>71-31965-00  652 274</p> 	<p>81-25516-10   646 265 31x50 A SL RD FPM</p>  <p>81-38229-00   614 827 90x104 A SL LD</p>  <p>81-24909-10   N 2x 56 36 970 35x48 A SL RD MVQ</p>  
--	---	---	--	---	---	---	--	---	---	---

OPEL/VAUXHALL



Ltr.  1.8 X 18 XE 85 kW (116 PS) ASTRA F ASTRA III  07/94-03/01

											
	<p>02-33000-02 16 06 914</p> 	<p>08-31965-01 16 06 834 +646 265</p> 		<p>61-33000-10 608 809 83 Ø 1,3 mm</p> 	<p>14-32104-01 607 256 (10x)</p> 	<p>15-31997-01 607 647 +607 648 (10x)</p>  <p>71-31997-00 607 647</p> 	<p>12-31306-01 642 533 (16x)</p>  <p>70-31306-10 642 533</p> 	<p>71-31976-00  850 655</p>  <p>71-31971-00  850 656</p>  <p>71-25865-00   854 933</p> 	<p>71-31965-00 652 274</p> 	<p>81-25516-10  646 265 31x50 A SL RD FPM</p>  <p>81-38229-00  614 827 90x104 A SL LD</p>  <p>81-24909-10  N 2x 56 36 970 35x48 A SL RD MVQ</p> 	

1.8 X 18 XE 85 kW (116 PS) VECTRA VECTRA B 09/95-09/00

	<p>02-33000-02 16 06 914</p> 	<p>08-31979-01  16 06 924 +646 265</p> 		<p>61-33000-10 608 809 83 Ø 1,3 mm</p> 	<p>14-32104-01 607 256 (10x)</p> 	<p>15-31997-01 607 647 +607 648 (10x)</p>  <p>71-31997-00 607 647</p> 	<p>12-31306-01 642 533 (16x)</p>  <p>70-31306-10 642 533</p> 	<p>71-31976-00  850 655</p>  <p>71-31971-00  850 656</p>  <p>71-25865-00   854 933</p> 	<p>71-31979-00  652 635</p>  <p>71-31978-00   652 636</p> 	<p>81-25516-10  646 265 31x50 A SL RD FPM</p>  <p>81-38229-00  614 827 90x104 A SL LD</p>  <p>81-24909-10  N 2x 56 36 970 35x48 A SL RD MVQ</p> 
--	---	---	--	---	---	--	---	---	---	--

OPEL/VAUXHALL

Ltr.  1.8 X 18 XE1 85 kW (115 PS) VECTRA  10/95-09/00 

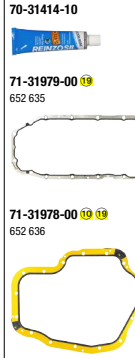
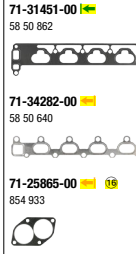
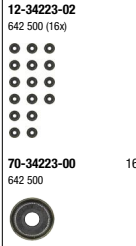
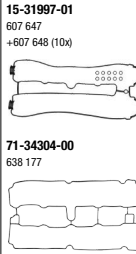
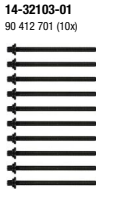
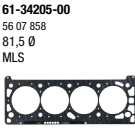
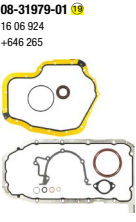
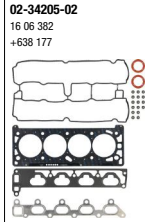
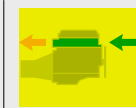

OPEL/VAUXHALL

Ltr.  1,8 X 18 XE1 85 kW (115-116 PS) ASTRA G ASTRA IV VECTRA ZAFIRA   11/96-08/05  2B999999, 2H999999, 21-28999999  2B999999, 2H999999, 21-28999999  2B999999, 2H999999, 21-28999999

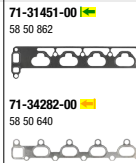
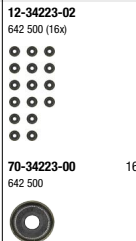
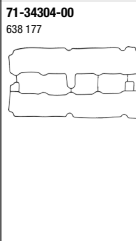
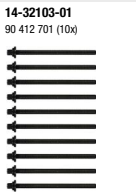
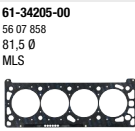
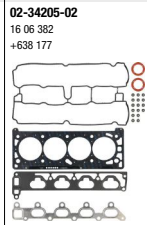
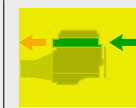

OPEL/VAUXHALL

Ltr. 1.8 X 18 XE1 85 kW (115-116 PS) ASTRA G ASTRA IV ZAFIRA 02/98-08/05

3B000001, 3H000001, 31-38999999→
3B000001, 3H000001, 31-38999999→
3B000001, 3H000001, 31-38999999→

























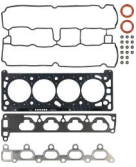

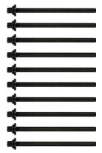
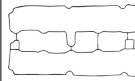











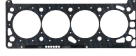
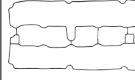



	<p>02-34205-02 16 06 382 +638 177</p>			<p>61-34205-00 56 07 858 81,5 Ø MLS</p>	<p>14-32103-01 90 412 701 (10x)</p>	<p>71-34304-00 638 177</p>	<p>12-34223-02 642 500 (16x)</p> <p>70-34223-00 642 500</p>	<p>71-31451-00 </p> <p>58 50 862</p> <p>71-34282-00 </p> <p>58 50 640</p>	<p>70-31414-10</p>	<p>81-35147-00 </p> <p>646 299 31,5x42 AB SL RD FPM</p> <p>81-24908-10 </p> <p>614 203 80x98 A SL LD FPM 20DR5879</p> <p>81-39433-00 </p> <p>56 14 844 80x98,39 A LD PTFE 20DR5880→</p> <p>81-24909-10 N 2x</p> <p>56 36 970 35x48 A SL RD MVQ</p>	

1.8 X 18 XE1 85 kW (116 PS) VECTRA 10/95-09/00

3B000001, 3H000001, 31-38999999→
3B000001, 3H000001, 31-38999999→
3B000001, 3H000001, 31-38999999→

	<p>02-34205-02 16 06 382 +638 177</p>			<p>61-34205-00 56 07 858 81,5 Ø MLS</p>	<p>14-32103-01 90 412 701 (10x)</p>	<p>71-34304-00 638 177</p>	<p>12-34223-02 642 500 (16x)</p> <p>70-34223-00 642 500</p>	<p>71-31451-00 </p> <p>58 50 862</p> <p>71-34282-00 </p> <p>58 50 640</p>		<p>81-15512-50 </p> <p>646 260 30x40 A SL RD FPM</p> <p>81-24908-10 </p> <p>614 203 80x98 A SL LD FPM</p> <p>81-24909-10 N 2x</p> <p>56 36 970 35x48 A SL RD MVQ</p>

OPEL/VAUXHALL

Ltr. 													
1,8 X 18 XE1 Z 18 XE	85-92 kW (115-125 PS) ASTRA IV ASTRA V MERIVA TIGRA VECTRA B VECTRA II	10/95-11/10		<p>02-34205-02 16 06 382 +638 177</p> 			<p>61-34205-00 56 07 858 81,5 Ø MLS</p> 	<p>14-32103-01 90 412 701 (10x)</p> 	<p>71-34304-00 638 177</p> 	<p>12-34223-02 642 500 (16x)</p>  <p>70-34223-00 642 500</p> 	<p>71-31451-00 </p> <p>58 50 862</p>  <p>71-34282-00 </p> <p>58 50 640</p>  <p>16x</p>	<p>70-31414-10</p> 	<p>81-15512-50 </p> <p>646 260 30x40 A SL RD FPM</p>  <p>81-24908-10 </p> <p>614 203 80x98 A SL LD FPM</p>  <p>81-24909-10 N 2x</p> <p>56 36 970 35x48 A SL RD MVQ</p> 
1,8 Z 18 XE	87 kW (118 PS) ASTRA IV	09/02-08/05					<p>61-34205-00 56 07 858 81,5 Ø MLS</p> 	<p>71-34304-00 638 177</p> 		<p>71-31451-00 </p> <p>58 50 862</p>  <p>71-34282-00 </p> <p>58 50 640</p> 		<p>81-15512-50 </p> <p>646 260 30x40 A SL RD FPM</p>  <p>81-24908-10 </p> <p>614 203 80x98 A SL LD FPM  20DR5879</p>  <p>81-39433-00 </p> <p>56 14 844 80x98,39 A LD PTFE  20DR5880→</p>  <p>81-24909-10 N 2x</p> <p>56 36 970 35x48 A SL RD MVQ</p> 	

OPEL/VAUXHALL

Ltr.  1.8 Z 18 XE

90-92 kW (122-125 PS)

ASTRA G
ASTRA IV
CORSA C
VECTRA C
VECTRA II
ZAFIRA
ZAFIRA

 2B999999,
2H999999, 21-28999999

 21-28999999

 2B999999,

2H999999, 21-28999999

 2B999999,

2H999999, 21-28999999

 2B999999,

2H999999, 21-28999999

 21-28999999

06/00-12/09 

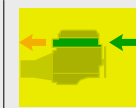

02-34205-02
16 06 382
+638 177

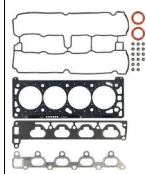

61-34205-00
56 07 858
81,5 Ø
MLS



14-32103-01
90 412 701 (10x)

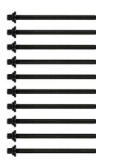

71-34304-00
638 177

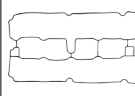

12-34223-02
642 500 (16x)





70-34223-00
642 500

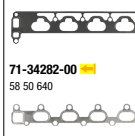

71-31451-00 

58 50 862



71-34282-00 

58 50 640



70-31414-10



81-15512-50 

646 260
30x40
A SL RD FPM

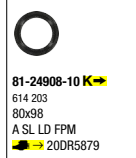

81-24908-10 

614 203
80x98
A SL LD FPM
 20DR5879



81-39433-00 

56 14 844
80x98,39
A LD PTFE
 20DR5880→



81-24909-10 **N**

56 36 970
35x48
A SL RD MVQ



2x

OPEL/VAUXHALL

Ltr.	Motor	Power	Models	Part Numbers	Dates	Image 1	Image 2	Image 3	Image 4	Image 5	Image 6	Image 7	Image 8	Image 9	Image 10	Image 11	Image 12	
1,8	Z 18 XE	90-92 kW (122-125 PS)	ASTRA G ASTRA H ASTRA IV CORSA C MERIVA SIGNUM TIGRA VECTRA C VECTRA II ZAFIRA ZAFIRA	<ul style="list-style-type: none"> 3B000001, 3H000001, 31-38999999→ 31-38999999→ 3B000001, 3H000001, 31-38999999→ 3B000001, 3H000001, 31-38999999→ 3B000001, 3H000001, 31-38999999→ 3B000001, 3H000001, 31-38999999→ 3B000001, 3H000001, 31-38999999→ 31-38999999→ 	06/00-12/10													<p>81-35147-00 K↔ 646 299 31,5x42 AB SL RD FPM</p> <p></p> <p>81-24908-10 K↔ 614 203 80x98 A SL LD FPM ↔ 20DR5879</p> <p></p> <p>81-39433-00 K↔ 56 14 844 80x98,39 A LD PTFE ↔ 20DR5880→</p> <p></p> <p>81-24909-10 N 2x 56 36 970 35x48 A SL RD MVQ</p> <p></p>
1,8	Z 18 XE	92 kW (125 PS)	ASTRA IV ASTRA IV	<ul style="list-style-type: none"> 2B999999, 2H999999, Z1-28999999 21-28999999 	02/98-08/04													<p>81-15512-50 K↔ 646 260 30x40 A SL RD FPM</p> <p></p> <p>81-39433-00 K↔ 56 14 844 80x98,39 A LD PTFE ↔ 20DR5880→</p> <p></p> <p>81-24909-10 N 2x 56 36 970 35x48 A SL RD MVQ</p> <p></p>

OPEL/VAUXHALL

Ltr.  1.8 Z 18 XE 92 kW (125 PS) ASTRA IV ASTRA IV  3B000001, 3H000001, 02/98-08/04  1 31-38000001→ 31-38999999→

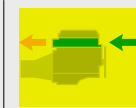

02-34205-02
16 06 382
+638 177

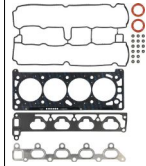

61-34205-00
56 07 858
81,5 Ø
MLS



14-32103-01
90 412 701 (10x)



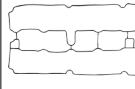

71-34304-00
638 177



12-34223-02
642 500 (16x)





71-31451-00 
58 50 862



70-31414-10



81-35147-00 
646 299
31,5x42
AB SL RD FPM



81-39433-00 
56 14 844
80x96,39
A LD PTFE
 20DR5880→



81-24909-10 **N** 2x
56 36 970
35x48
A SL RD MVQ



1.8 Z 18 XE 92 kW (125 PS) ASTRA IV CORSA II 08/00-09/06

02-34205-02
16 06 382
+638 177

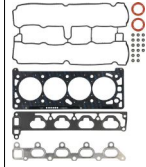

61-34205-00
56 07 858
81,5 Ø
MLS

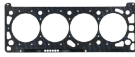

14-32103-01
90 412 701 (10x)



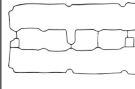

71-34304-00
638 177



12-34223-02
642 500 (16x)





71-31451-00 
58 50 862





70-31414-10

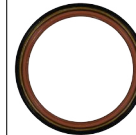

81-24908-10 
614 203
80x98
A SL LD FPM
 20DR5879





81-39433-00 
56 14 844
80x96,39
A LD PTFE
 20DR5880→



81-24909-10 **N** 2x
56 36 970
35x48
A SL RD MVQ



OPEL/VAUXHALL

Ltr.  1.8 Z 18 XE 92 kW (125 PS) VECTRA  09/00-07/03  1

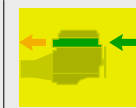

1.8 Z 18 XE 92 kW (125 PS) VECTRA 09/00-07/03

02-34205-02
16 06 382
+638 177

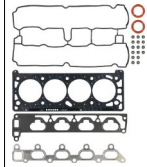

61-34205-00
56 07 858
81,5 Ø
MLS



14-32103-01
90 412 701 (10x)



71-34304-00
638 177

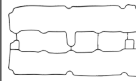

12-34223-02
642 500 (16x)



70-34223-00
642 500



71-31451-00 
58 50 862



71-34282-00 
58 50 640





16x

70-31414-10



81-15512-50 
646 260
30x40
A SL RD FPM



81-24908-10 
614 203
80x98
A SL LD FPM
 20DR5879

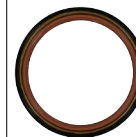

81-39433-00 
56 14 844
80x98,39
A LD PTFE
 20DR5880→



81-24908-10 
614 203
80x98
A SL LD FPM

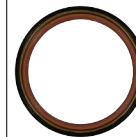





81-24909-10  **N** 2x
56 36 970
35x48
A SL RD MVQ

















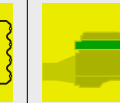
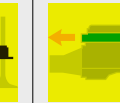
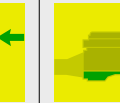
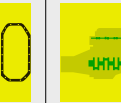
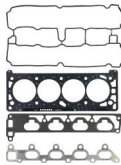

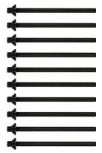
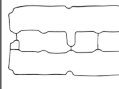
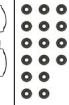









OPEL/VAUXHALL

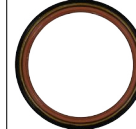























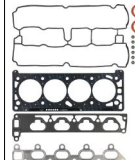

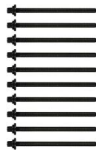
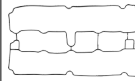











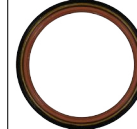





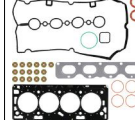



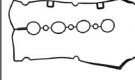
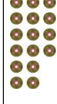

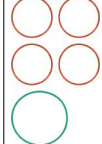
Ltr.  1.8 Z 18 XEL 79-85 kW (107-116 PS) ASTRA G CORSA C VECTRA B VECTRA C

 10/95-12/10

 2B999999, 2H999999, 21-28999999
 2B999999, 2H999999, 21-28999999
 2B999999, 2H999999, 21-28999999
 2B999999, 2H999999, 21-28999999

										
	<p>02-34205-02 16 06 382 +638 177</p> 			<p>61-34205-00 56 07 858 81,5 Ø MLS</p> 	<p>14-32103-01 90 412 701 (10x)</p> 	<p>71-34304-00 638 177</p> 	<p>12-34223-02 642 500 (16x)</p>  <p>70-34223-00 642 500</p> 	<p>71-31451-00 </p>  <p>71-34282-00 </p>  <p>16x</p>	<p>70-31414-10</p> 	<p>81-15512-50 </p>  <p>646 260 30x40 A SL RD FPM</p> <p>81-24908-10 </p>  <p>614 203 80x98 A SL LD FPM  20DR5879</p>  <p>81-39433-00 </p>  <p>56 14 844 80x98,39 A LD PTFE  20DR5880→</p>  <p>81-24909-10 N</p>  <p>56 36 970 35x48 A SL RD MVQ</p> 













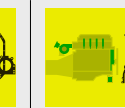

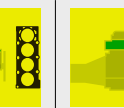

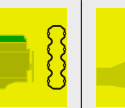
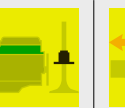
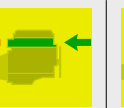

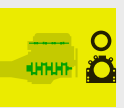
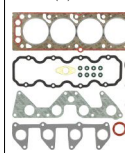

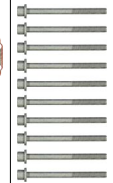

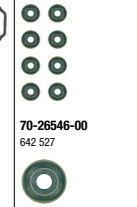

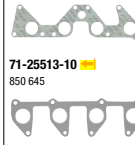

OPEL/VAUXHALL

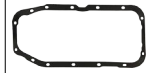
Ltr. 													
1,8 Z 18 XEL	79-85 kW (107-116 PS) ASTRA G CORSA C VECTRA B VECTRA C	10/95-12/10		<p>02-34205-02 16 06 382 +638 177</p>			<p>61-34205-00 56 07 858 81,5 Ø MLS</p> 	<p>14-32103-01 90 412 701 (10x)</p> 	<p>71-34304-00 638 177</p> 	<p>12-34223-02 642 500 (16x)</p>  <p>70-34223-00 642 500</p> 	<p>71-31451-00 </p> <p>58 50 862</p>  <p>71-34282-00 </p> <p>58 50 640</p>  <p>16x</p>	<p>70-31414-10</p> 	<p>81-35147-00 </p> <p>646 299 31,5x42 AB SL RD FPM</p>  <p>81-24908-10 </p> <p>614 203 80x98 A SL LD PFM  20DR5879</p>  <p>81-39433-00 </p> <p>56 14 844 80x98,39 A LD PTFE  20DR5880→</p>  <p>81-24909-10 N </p> <p>56 36 970 35x48 A SL RD MVQ</p> 
1,8 Z 18 XER	103 kW (140 PS) ASTRA H	01/12-05/14		<p>02-37240-01 16 06 537</p>	<p>08-38431-01 16 06 536</p> 		<p>61-37240-00 56 07 895 82 Ø 0,65 mm MLS</p> 	<p>14-32103-01 90 412 701 (10x)</p> 	<p>71-38166-00 56 07 980</p> 	<p>12-36613-01 642 002 (16x)</p>  <p>70-36613-00 24 405 819</p> 	<p>11-38221-01 </p> <p>58 50 345</p>  <p>71-38158-00 </p> <p>849 533</p> 	<p>70-31414-10</p> 	<p>81-35147-00 </p> <p>646 299 31,5x42 AB SL RD FPM</p>  <p>81-38236-00 </p> <p>614 135 80x98 A LD PTFE ACM</p>  <p>81-24909-10 N </p> <p>56 36 970 35x48 A SL RD MVQ</p> 











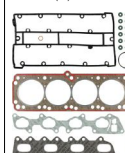

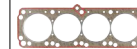



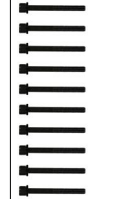

OPEL/VAUXHALL																		
1.8	18 E 18 N 18 S	55-85 kW (75-115 PS)	ASCONA C ASTRA II ASTRA V CARLTON II CAVALIER II KADETT D KADETT E MANTA B REKORD E	09/81-08/91		02-25080-02 16 06 669 +642 526 (8x)	08-13017-04 16 06 678			61-25080-20 607 991 86,3 Ø 1,3 mm	14-32037-01 607 685 (10x)	71-13016-00 638 646	12-26545-01 642 526 (8x)	71-26007-10 850 719	71-13017-00 652 586	81-25516-10 646 265 31x50 A SL RD FPM	81-25517-00 614 817 86x104 A SL LD FPM	81-24909-10 N 56 36 970 35x48 A SL RD MVQ
1.8	18 SE	82-85 kW (111-116 PS)	ASTRA F ASTRA II ASTRA III CAVALIER II KADETT E	09/81-02/98		02-25080-02 16 06 669 +642 526 (8x) 14360690	08-13017-04 16 06 678 14360690		61-25080-20 607 991 86,3 Ø 1,3 mm 14360690	14-32037-01 607 685 (10x)	71-13016-00 638 646 14360690	12-26545-01 642 526 (8x) 14360690	71-26007-10 850 719 14360690	71-13017-00 652 586 14360690	81-25516-10 646 265 31x50 A SL RD FPM	81-25517-00 614 817 86x104 A SL LD FPM 14360690	81-38229-00 614 827 90x104 A SL LD 14360691→	81-24909-10 N 56 36 970 35x48 A SL RD MVQ
						02-27275-04 16 06 682 +642 527 (8x) 14360691→	08-27293-02 16 06 663 14360691→		61-27275-10 607 986 86,3 Ø 1,3 mm 14360691→	71-13045-30 638 192 14360691→	12-26546-01 642 527 (8x) 14360691→	71-25513-10 850 645	71-25865-00 06 854 933	71-27293-00 652 587 14360691→	81-25516-10 646 265 31x50 A SL RD FPM	81-25517-00 614 817 86x104 A SL LD FPM 14360690	81-38229-00 614 827 90x104 A SL LD 14360691→	81-24909-10 N 56 36 970 35x48 A SL RD MVQ

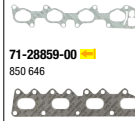
OPEL/VAUXHALL



























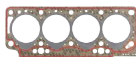
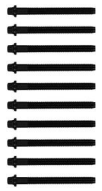
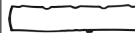





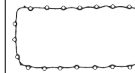













Ltr.  1,8 18 SEH  85 kW (115 PS) CARLTON III OMEGA A  09/86-03/94 **1**

											
	<p>02-27275-04 16 06 682 +642 527 (8x)</p> 	<p>08-27293-02 16 06 663</p> 		<p>61-27275-10 607 986 86,3 Ø 1,3 mm</p> 	<p>14-32037-01 607 685 (10x)</p> 	<p>71-13045-30 638 192</p> 	<p>12-26546-01 642 527 (8x)</p> 	<p>71-26510-10 </p> <p>642 527 (8x)</p>  <p>71-25513-10 </p> <p>850 645</p> <p>71-25865-00  </p> <p>854 933</p> 	<p>71-27293-00 652 587</p> 	<p>81-25516-10 </p> <p>646 265 31x50 A SL RD FPM</p>  <p>81-38229-00 </p> <p>614 827 90x104 A SL LD</p>  <p>81-24909-10 </p> <p>56 36 970 35x48 A SL RD MVQ</p>  <p>81-27317-00 </p> <p>636 839 55x70,1 AB LD FPM</p> 	

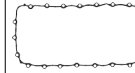





























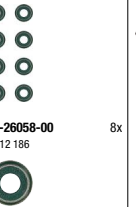



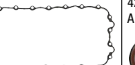















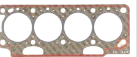





1,9 C 20 XE 110 kW (149 PS) ASTRA II 03/88-08/91

	<p>02-28235-01 16 06 687 +642 527 (16x) +636 841 (2x)</p> 	<p>08-13054-02 16 06 688</p> 		<p>61-28235-10 607 983 87,5 Ø 1,29 mm</p> 	<p>14-32040-01 607 248 (10x)  14137011</p>  <p>14-32104-01 607 256 (10x)  14137012→</p> 	<p>71-28233-00 607 643</p> 	<p>12-26546-01 642 527 (8x)</p> 	<p>71-28234-10 </p> <p>850 606</p>  <p>71-28859-00 </p> <p>850 646</p>	<p>71-13054-10 652 599</p> 	<p>81-28236-00 </p> <p>646 269 38x50 A SL RD FPM</p>  <p>81-38229-00 </p> <p>614 827 90x104 A SL LD</p>  <p>81-24909-10 </p> <p>56 36 970 35x48 A SL RD MVQ</p> 
--	--	--	--	--	---	---	---	---	---	--



























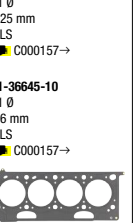











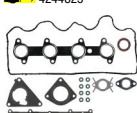
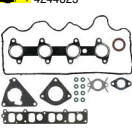
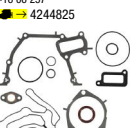





















PEL/VAUXHALL

<p>Ltr. </p>	<p></p>	<p></p>											
<p>1,9 F8Q 600 F8Q 606 19 DJ 19 DL</p>	<p>44 kW (60 PS) ARENA D</p>	<p>01/97-12/01</p>	<p>02-26391-07 44 05 802</p> 	<p>08-34414-02</p> 		<p>61-33685-00 44 01 560 81 Ø 1,4 mm</p> <p>61-33685-10 44 01 518 81 Ø 1,5 mm</p> <p>61-33685-20 44 01 561 81 Ø 1,6 mm</p> 	<p>14-32161-01 44 01 371 (10x)</p> 	<p>71-26391-00 44 01 504</p> 	<p>12-25837-01 44 01 804 (8x)</p>  <p>70-25837-00 44 01 804</p> 	<p>71-33647-00  </p> <p>44 02 601</p> 	<p>71-34414-00 44 02 981</p> 	<p>81-34413-00 K </p> <p>44 02 706 42x54 A SL RD FPM/ACM</p>  <p>81-34417-10 K </p> <p>44 047 963 85x105 A SL LD FPM</p>  <p>81-26389-30 N</p> <p>44 04 965 25x42 A SL RD FPM</p> 	
<p>1,9 F9Q 760 F9Q 762 F9Q 774</p>	<p>59-74 kW (80-101 PS) MOVANO DTI VIVARO DI VIVARO DTI</p>	<p>08/01</p>	<p>02-34409-01 44 02 544</p> 	<p>08-34414-02</p> 	<p>04-10034-01 </p> 	<p>61-36645-00 44 08 100 81 Ø 1,25 mm MLS</p> <p>61-36645-10 81 Ø 1,6 mm MLS</p> 	<p>14-32146-01 44 04 071 (10x)</p> 	<p>71-34409-00 44 08 006</p> 	<p>12-26058-02 44 12 186 (8x)</p>  <p>70-26058-00 44 12 186</p> 	<p>71-34411-00  </p> <p>44 02 641</p> 	<p>71-34414-00 44 02 981</p> 	<p>81-34413-00 K </p> <p>44 02 706 42x54 A SL RD FPM/ACM</p>  <p>81-34417-10 K </p> <p>44 047 963 85x105 A SL LD FPM</p>  <p>81-26389-30 N</p> <p>44 04 965 25x42 A SL RD FPM</p> 	























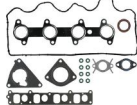







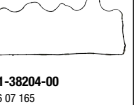



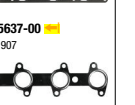





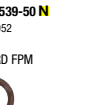

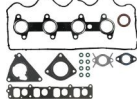
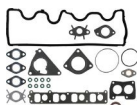







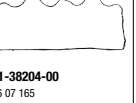

OPEL/VAUXHALL

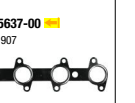
Ltr. 											
1,9 F9Q 760 F9Q 762 60-74 kW (82-101 PS) VIVARO DI VIVARO DTI 02/01-07/14 		02-34409-01 44 02 544 	08-34414-02 		61-36645-00 44 08 100 81 Ø 1,25 mm MLS 61-36645-10 81 Ø 1,6 mm MLS 	14-32146-01 44 04 071 (10x) 	71-34409-00 44 08 006 	12-26058-02 44 12 186 (8x) 	71-34411-00   44 02 641 	71-34414-00 44 02 981 	81-34413-00  44 02 706 42x54 A SL RD FPM/ACM  81-34417-10  44 04 963 85x105 A SL LD FPM  81-26389-30 N 44 04 965 25x42 A SL RD FPM 
1,9 F9Q 770 59 kW (80 PS) MOVANO DTI 09/00-10/01		02-34409-01 44 02 544 	08-34414-02 	04-10102-01  	61-34115-00 44 02 581 81 Ø 1,35 mm  C000156 2  61-34115-10 44 02 582 81 Ø 1,45 mm  C000156 1  61-34115-20 44 02 583 81 Ø 1,55 mm  C000156 3   61-36645-00 44 08 100 81 Ø 1,25 mm MLS  C000157 → 61-36645-10 81 Ø 1,6 mm MLS  C000157 → 	14-32146-01 44 04 071 (10x) 	71-34409-00 44 08 006 	12-26058-02 44 12 186 (8x) 	71-34411-00   44 02 641 	71-34414-00 44 02 981 	81-34413-00  44 02 706 42x54 A SL RD FPM/ACM  81-34417-10  44 04 963 85x105 A SL LD FPM  81-26389-30 N 44 04 965 25x42 A SL RD FPM 

OPEL/VAUXHALL



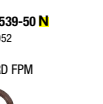





















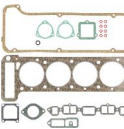
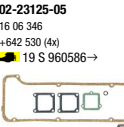
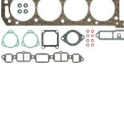

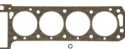
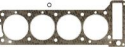























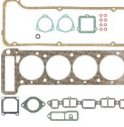
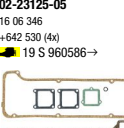
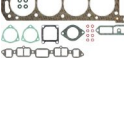
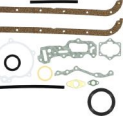

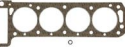















Ltr. 											
1,9 F9Q 772 60 kW (82 PS) MOVANO DTI 10/01		02-34409-01 44 02 544	08-34414-02 	04-10034-01  	61-36645-00 44 08 100 81 Ø 1,25 mm MLS 	14-32146-01 44 04 071 (10x)	71-34409-00 44 08 006	12-26058-02 44 12 186 (8x)	71-34411-00          44 02 641	71-34414-00 44 02 981	81-34413-00   44 02 706 42x54 A SL RD FPM/ACM
1,9 Z 19 DT Z 19 DTL 74-88 kW (100-120 PS) ASTRA H CDTI ASTRA V CDTI SIGNUM CDTI VECTRA C CDTI ZAFIRA CDTI 04/04-04/15		02-35638-03 16 06 256 	08-36316-01 16 06 253 +16 06 257 	04-10209-01  	61-35580-00 56 07 843 83 Ø 0,82 mm 61-35580-10 56 07 845 83 Ø 0,92 mm	14-35738-01 56 07 961 (10x)	71-35638-10 56 07 853 	12-25837-01 44 01 804 (8x)	71-36306-00          58 50 828	70-31414-10 	81-35682-00   56 46 262 31x41 AB SL RD FPM
		02-38204-02 16 06 329 	08-36278-01 16 06 336 	61-35580-20 56 07 847 83 Ø 1,02 mm	14-32321-01 607 754 (10x)	71-38204-00 56 07 165 	70-25837-00 44 01 804	71-35637-00          58 49 907	81-90027-00   614 965 93 Ø	81-17539-50   45 06 052 30x42 A SL RD FPM	

OPEL/VAUXHALL

























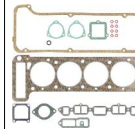
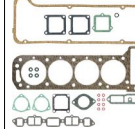
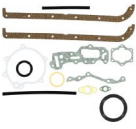

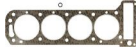























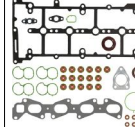











































<p>Ltr. </p>											
<p>1,9 Z 19 DT 88 kW (120 PS) ASTRA V CDTI 08/04-03/09</p>	<p>02-35638-03 16 06 256 → 4244825</p>  <p>02-38204-02 16 06 329 → 4244826→</p> 	<p>08-36316-01 16 06 253 +16 06 257 → 4244825</p>  <p>08-36278-01 16 06 336 → 4244826→</p> 	<p>04-10208-01 </p> 	<p>61-35580-00 56 07 843 83 Ø 0,82 mm</p> <p>61-35580-10 56 07 845 83 Ø 0,92 mm</p> <p>61-35580-20 56 07 847 83 Ø 1,02 mm</p> 	<p>14-35738-01 56 07 961 (10x) → 5685170</p>  <p>14-32321-01 607 754 (10x) → 5685171→</p> 	<p>71-35638-10 56 07 853 → 4244825</p>  <p>71-38204-00 56 07 165 → 4244826→</p> 	<p>12-25837-01 44 01 804 (8x)</p>  <p>70-25837-00 44 01 804</p> 	<p>71-36306-00 </p> <p>58 50 828</p>  <p>71-35637-00 </p> <p>58 49 907</p> 	<p>70-31414-10</p> 	<p>81-35882-00 </p> <p>56 46 262 31x41 AB SL RD FPM</p>  <p>81-90027-00 </p> <p>614 965 93 Ø</p>  <p>81-17539-50 N</p> <p>45 06 052 30x42 A SL RD FPM</p> 	
<p>1,9 Z 19 DT 88 kW (120 PS) ASTRA V CDTI ASTRAVAN CDTI SIGNUM CDTI VECTRA II CDTI ZAFIRA II CDTI 04/02-11/14</p>	<p>02-35638-03 16 06 256 → 4244825</p>  <p>02-38204-02 16 06 329 → 4244826→</p> 	<p>08-36316-01 16 06 253 +16 06 257 → 4244825</p>  <p>08-36278-01 16 06 336 → 4244826→</p> 	<p>04-10208-01 </p> 	<p>61-35580-00 56 07 843 83 Ø 0,82 mm</p> <p>61-35580-10 56 07 845 83 Ø 0,92 mm</p> <p>61-35580-20 56 07 847 83 Ø 1,02 mm</p> 	<p>14-35738-01 56 07 961 (10x) → 5685170</p>  <p>14-32321-01 607 754 (10x) → 5685171→</p> 	<p>71-35638-10 56 07 853 → 4244825</p>  <p>71-38204-00 56 07 165 → 4244826→</p> 	<p>12-25837-01 44 01 804 (8x)</p>  <p>70-25837-00 44 01 804</p> 	<p>71-36306-00 </p> <p>58 50 828</p>  <p>71-35637-00 </p> <p>58 49 907</p> 	<p>70-31414-10</p> 	<p>81-35882-00 </p> <p>56 46 262 31x41 AB SL RD FPM</p>  <p>81-90027-00 </p> <p>614 965 93 Ø</p>  <p>81-17539-50 N</p> <p>45 06 052 30x42 A SL RD FPM</p> 	

OPEL/VAUXHALL															
1,9	Z 19 DTH Z 19 DTJ	88-110 kW (120-150 PS)	ASTRA CDTI ASTRA H CDTI ASTRA V CDTI SIGNUM CDTI VECTRA C CDTI VECTRA II CDTI ZAFIRA CDTI ZAFIRA II CDTI	01/04-04/15	 02-36262-01 16 06 254 → 17180894	 08-36316-01 16 06 253 +16 06 257	 04-10208-01	 61-35855-00 56 07 875 83 Ø 0,82 mm MLS	 14-32332-01 56 07 692 (10x)	 71-36262-00 56 07 969 → 17180894	 12-36208-01 642 049 (16x) → 17180894	 71-36307-00 849 528	 70-31414-10	 81-35882-00 56 46 262 31x41 AB SL RD FPM	
					 02-41094-01 → 17180895→			 61-35855-10 56 07 876 83 Ø 0,92 mm MLS	 61-35855-20 56 07 877 83 Ø 1,02 mm MLS	 71-41094-00 56 07 273 → 17180895→	 12-38209-02 642 697 (16x) → 17180895→	 71-35658-00 849 529		 81-90027-00 614 965 93 Ø	
											 70-36208-00 642 049 → 17180894	 70-38209-00 642 697 → 17180895→	16x		 81-36229-00 56 36 817 30x45 AB SL RD FPM
1,9	19 E	77 kW (105 PS)	KADETT C MANTA A MANTA B	02/74-08/77	 02-23125-06 16 06 379 +642 530 (4x)	 08-12841-06 16 06 598 +614 815		 61-23125-20 607 984 +638 182 95 Ø 0,75 mm		 71-12944-00 607 664	 12-27431-02 642 452 (4x) +642 530 (4x)	 71-20654-10 850 619	 10-12841-02 16 06 230	 81-19195-00 638 187 45x60 A SL RD ACM	
											 40-77344-00 642 452	 70-27431-00 642 530	4x		 81-20667-30 90 156 857 77x100 A SL LD FPM
											 70-27431-00 642 530	 71-23862-10 854 841	4x		 81-20667-30 90 156 857 77x100 A SL LD FPM
1,9	19 N	55 kW (75 PS)	ASCONA A ASCONA B MANTA B REKORD B REKORD D REKORD E	09/65-10/82	 02-23125-05 16 06 346 +642 530 (4x)	 08-12841-06 16 06 598 +614 815		 61-23125-20 607 984 +638 182 95 Ø 0,75 mm		 71-12944-00 607 664	 12-27431-02 642 452 (4x) +642 530 (4x)	 71-20654-10 850 619	 10-12841-02 16 06 230	 81-19195-00 638 187 45x60 A SL RD ACM	
											 40-77344-00 642 452	 71-19846-10 854 835	4x		 81-20667-30 90 156 857 77x100 A SL LD FPM
											 70-27431-00 642 530	 71-23862-10 854 841	4x		 81-20667-30 90 156 857 77x100 A SL LD FPM























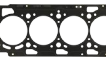





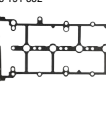

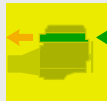













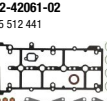



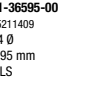



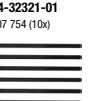

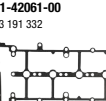

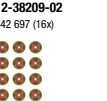
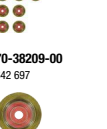





OPEL/VAUXHALL

Ltr. 													
1,9 19 S	65-66 kW (88-90 PS) ASCONA A ASCONA B GT KADETT B MANTA A MANTA B OLYMPIA A REKORD B REKORD C	08/65-08/81	  	02-22010-05 16 06 265 → 19 S 946010 02-23125-05 16 06 346 +642 530 (4x) → 19 S 960586→	08-12841-06 16 06 598 +614 815  		61-22010-20 607 469 +638 182 95 0 0,75 mm → 19 S 946010  61-23125-20 607 984 +638 182 95 0 0,75 mm → 19 S 960586→ 		71-12944-00 607 664 	12-27431-02 642 452 (4x) +642 530 (4x) → 19 S 960586→     40-77344-00 642 452 → 19 S 946010  40-77344-00 AS 642 452 → 19 S 960586→  70-27431-00 ES 642 530 → 19 S 960586→ 	71-20654-10    850 619  71-23862-10   854 841 → 19 S 960586→  71-19846-10   854 835 	10-12841-02 16 06 230  	81-19195-00 K  638 187 45x60 A SL RD ACM  81-20667-30 K  90 156 857 77x100 A SL LD FPM 
1,9 19 S	66 kW (90 PS) CAVALIER	10/75-03/78	  	02-22010-05 16 06 265 → 19 S 946010 02-23125-05 16 06 346 +642 530 (4x) → 19 S 960586→	08-12841-06 16 06 598 +614 815  		61-22010-20 607 469 +638 182 95 0 0,75 mm → 19 S 946010  61-23125-20 607 984 +638 182 95 0 0,75 mm → 19 S 960586→ 		71-12944-00 607 664 → 19 S 960586→ → 19 S 946010 	12-27431-02 642 452 (4x) +642 530 (4x) → 19 S 960586→     40-77344-00 642 452 → 19 S 946010  40-77344-00 AS 642 452 → 19 S 960586→  70-27431-00 ES 642 530 → 19 S 960586→ 	71-20654-10    850 619  71-23862-10   854 841 → 19 S 960586→  71-19846-10   854 835 	10-12841-02 16 06 230  	81-19195-00 K  638 187 45x60 A SL RD ACM  81-20667-30 K  90 156 857 77x100 A SL LD FPM 















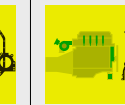
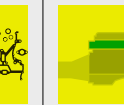
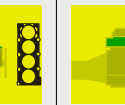

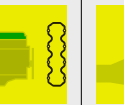
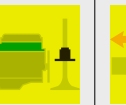
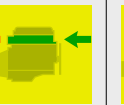

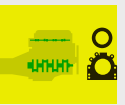



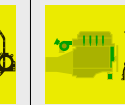
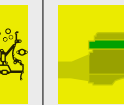
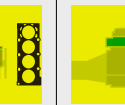

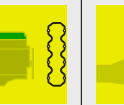
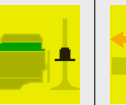
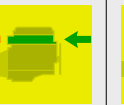
OPEL/VAUXHALL

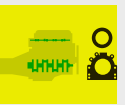
<p>Ltr.  19 SH</p> <p> 66-78 kW (90-106 PS) REKORD C REKORD D</p> <p> 08/67-08/77</p>											
<p>1,9 19 SH</p> <p>66-78 kW (90-106 PS) REKORD C REKORD D</p> <p>08/67-08/77</p>	<p>02-22010-05 16 06 265 ➔ 19 SH 43947</p>  <p>02-23125-05 16 06 346 +642 530 (4x) ➔ 19 SH 300001→</p> 	<p>08-12841-06 16 06 598 +614 815</p> 		<p>61-22010-20 607 469 +638 182 95 Ø 0,75 mm ➔ 19 SH 43947</p>  <p>61-23125-20 607 984 +638 182 95 Ø 0,75 mm ➔ 19 SH 300001→</p> 		<p>71-12944-00 607 664</p> 	<p>12-27431-02 642 452 (4x) +642 530 (4x) ➔ 19 SH 300001→</p>     <p>40-77344-00 8x 642 452 ➔ 19 SH 43947</p>  <p>40-77344-00 AS 4x 642 452 ➔ 19 SH 300001→</p>  <p>70-27431-00 ES 4x 642 530 ➔ 19 SH 300001→</p> 	<p>71-20654-10   850 619</p>     <p>71-19846-10   854 835</p> 	<p>10-12841-02 16 06 230</p>  	<p>81-19195-00 K  638 187 45x60 A SL RD ACM</p>  <p>81-20667-30 K  90 156 857 77x100 A SL LD FPM</p> 	
<p>2,0 A 20 DT A 20 DTE A 20 DTH A 20 DTL A 20 DTR</p> <p>81-143 kW (110-195 PS) ASTRA J T CDTI ASTRA VI ASTRA VI CDTI CASCADA CDTI INSIGNIA Biturbo CDTI INSIGNIA CDTI INSIGNIA CDTI Biturbo INSIGNIA S T CDTI Biturbo ZAFIRA C T CDTI ZAFIRA CDTI ZAFIRA III CDTI</p> <p>07/08</p>	<p>02-39354-01</p> 	<p>08-39648-01</p> 		<p>61-37665-00 55 574 904 84 Ø 0,95 mm MLS</p> <p>61-37665-10 55 574 905 1,05 mm MLS </p> <p>61-37665-20 55 574 906 1,15 mm MLS </p> 	<p>14-32332-01 56 07 692 (10x)</p> 	<p>71-42061-00 93 191 332</p> 	<p>12-38209-02 642 697 (16x)</p>                <p>70-38209-00 16x 642 697</p> 	<p>11-40692-01  850 336</p>                <p>71-39352-00  93 192 536</p>       	<p>70-31414-10</p> 	<p>81-35882-00 K  56 46 262 31x41 AB SL RD FPM</p>  <p>81-90027-00 K  614 965 93 Ø</p>  <p>81-36229-00 N 56 36 817 30x45 AB SL RD FPM</p>  <p>81-40269-00 N  55 574 601 30x50 AW SL RD FPM</p> 	

OPEL/VAUXHALL

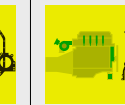
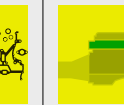
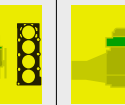
<p>Ltr.    1</p> <p>2,0 A 20 DTC A 20 DTH A 20 DTJ Y 20 DTJ Z 20 DTJ</p> <p>81-121 kW (110-165 PS)</p> <p>ASTRA CDTI ASTRA J ASTRA J CDTI ASTRA VI CDTI ASTRA VI CDTI CASCADA CDTI INSIGNIA CDTI ZAFIRA CDTI ZAFIRA III CDTI</p> <p>07/08</p>		 <p>02-39354-01</p> 	 <p>08-39648-01</p> 	 <p>04-10320-01 </p> 	 <p>61-37665-00 55 574 904 84 Ø 0,95 mm MLS</p> <p>61-37665-10 55 574 905 1,05 mm MLS</p> <p>61-37665-20 55 574 906 1,15 mm MLS</p>  <p>1 </p> <p>2 </p>	 <p>14-32332-01 56 07 692 (10x)</p> 	 <p>71-42061-00 93 191 332</p> 	 <p>12-38209-02 642 697 (16x)</p> <p>70-38209-00 642 697</p> <p>16x</p> 	 <p>11-40692-01 </p> <p>850 336</p>  <p>71-39352-00 </p> <p>93 192 536</p> 	 <p>70-31414-10</p> 	 <p>81-35882-00 </p> <p>56 46 262 31x41 AB SL RD FPM</p>  <p>81-90027-00 </p> <p>614 965 93 Ø</p>  <p>81-36229-00 N</p> <p>56 36 817 30x45 AB SL RD FPM</p>  <p>81-40269-00 N </p> <p>55 574 601 30x50 AW SL RD FPM</p> 
<p>2,0 A 20 FD</p> <p>99 kW (135 PS)</p> <p>COMBO CDTI</p> <p>11/11</p>		 <p>02-42061-02 95 512 441</p> 	 <p>08-36278-03 95 512 439</p> 		 <p>61-36595-00 55211409 84 Ø 0,95 mm MLS</p> <p>61-36595-10 55 211 410 84 Ø 1,05 mm MLS</p> <p>61-36595-20 55 211 411 84 Ø 1,15 mm MLS</p>  <p>0</p> <p>1 </p> <p>2 </p>	 <p>14-32321-01 607 754 (10x)</p> 	 <p>71-42061-00 93 191 332</p> 	 <p>12-38209-02 642 697 (16x)</p> <p>70-38209-00 642 697</p> <p>16x</p> 	 <p>11-40692-01 </p> <p>850 336</p>  <p>71-39352-00 </p> <p>93 192 536</p>  <p>71-42072-00 </p> 	 <p>70-31414-10</p> 	 <p>81-35882-00 </p> <p>56 46 262 31x41 AB SL RD FPM</p>  <p>81-90027-00 </p> <p>614 965 93 Ø</p>  <p>81-36229-00 N</p> <p>56 36 817 30x45 AB SL RD FPM</p> 

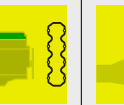
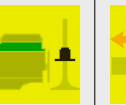
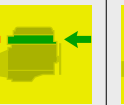
PEL/VAUXHALL

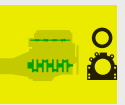
<p>Ltr. </p>	<p>2,0 A 20 NFT</p>	<p>162 kW (220 PS)</p>	<p>INSIGNIA Turbo</p>	<p>07/08-05/17</p>												
<p>2,0 A 20 NFT</p>	<p>162 kW (220 PS)</p>	<p>INSIGNIA INSIGNIA Turbo</p>	<p>07/08-05/17</p>													
<p>2,0 A 20 NFT</p>	<p>206 kW (280 PS)</p>	<p>ASTRA J ASTRA VI GTC</p>	<p>04/12</p>													

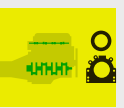
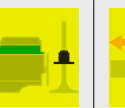
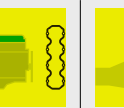
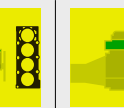
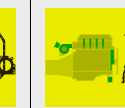

02-37265-01

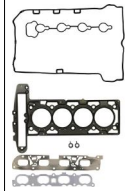

08-39572-01



61-37265-00

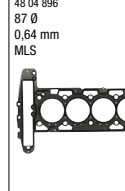

14-10018-01

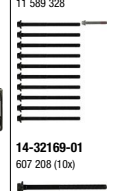

15-11037-01

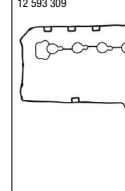

12-34264-01

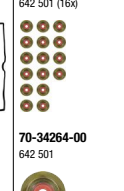

71-38154-00

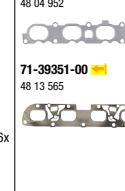

70-31414-10



81-33489-10

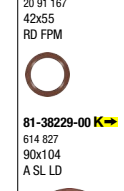

81-38229-00

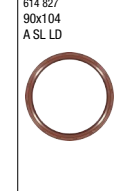

02-37265-01

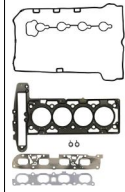

08-39572-01



61-37265-00

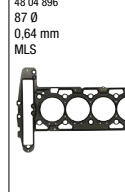

14-32169-01



15-11037-01

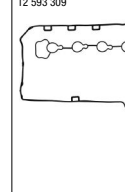

12-34264-01

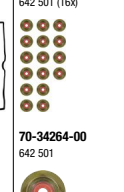

71-38154-00

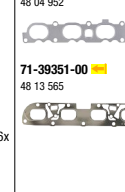

70-31414-10



81-33489-10

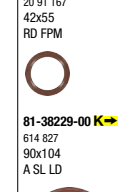

81-38229-00



02-37265-01

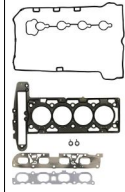

08-39572-01



61-37265-00

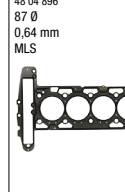

14-10018-01

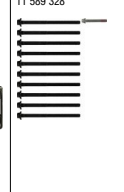

15-11037-01

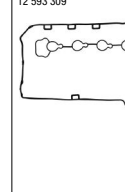

12-34264-01

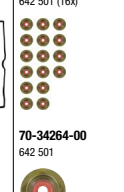

71-38154-00

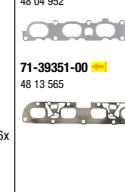

70-31414-10

















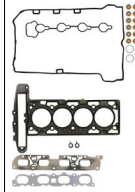







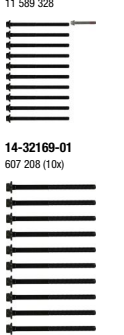

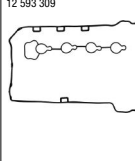

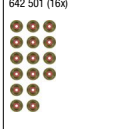



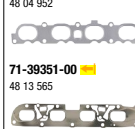









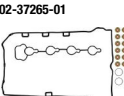







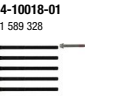

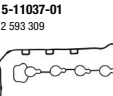
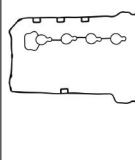
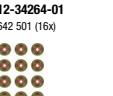
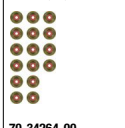













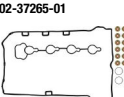







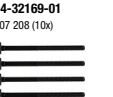
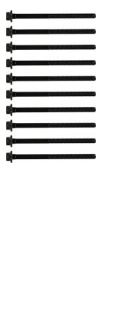
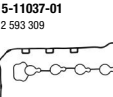
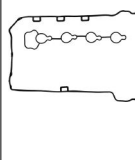

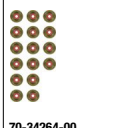

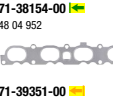

81-33489-10



81-38229-00



OPEL/VAUXHALL













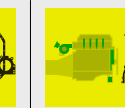

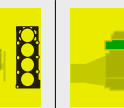

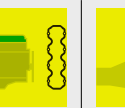
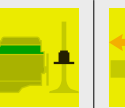
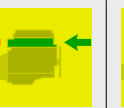

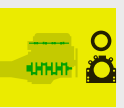
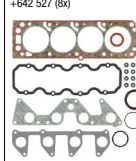

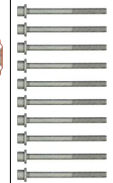









<p>Ltr.  A 20 NHT</p> <p> 162-184 kW (220-250 PS) INSIGNIA Turbo</p> <p> 07/08-05/17 [NEW]</p>		 <p>02-37265-01</p> 	 <p>08-39572-01</p> 	 <p>04-10378-01 </p> 	 <p>61-37265-00 48 04 896 87 Ø 0,64 mm MLS</p> 	 <p>14-10018-01 11 589 328</p> 	 <p>15-11037-01 12 593 309</p> 	 <p>12-34264-01 642 501 (16x)</p>  <p>70-34264-00 642 501</p>  <p>16x</p>	 <p>71-38154-00  48 04 952</p>  <p>71-39351-00  48 13 565</p> 	 <p>70-31414-10 </p>	 <p>81-33489-10  20 91 167 42x55 RD FPM</p>  <p>81-38229-00  614 827 90x104 A SL LD</p> 
<p>2,0 A 20 NHT B 20 NFT</p> <p>162-206 kW (220-280 PS) ASTRA J ASTRA VI GTC INSIGNIA CDTI INSIGNIA Turbo</p> <p>07/08 [NEW]</p>		 <p>02-37265-01</p> 	 <p>08-39572-01</p> 	 <p>04-10378-01 </p> 	 <p>61-37265-00 48 04 896 87 Ø 0,64 mm MLS</p> 	 <p>14-10018-01 11 589 328</p> 	 <p>15-11037-01 12 593 309</p> 	 <p>12-34264-01 642 501 (16x)</p>  <p>70-34264-00 642 501</p>  <p>16x</p>	 <p>71-38154-00  48 04 952</p>  <p>71-39351-00  48 13 565</p> 	 <p>70-31414-10 </p>	 <p>81-33489-10  20 91 167 42x55 RD FPM</p>  <p>81-38229-00  614 827 90x104 A SL LD</p> 
<p>2,0 A 20 NHT</p> <p>184 kW (250 PS) INSIGNIA INSIGNIA Turbo INSIGNIA Turbo</p> <p>07/11-05/17 [NEW]</p>		 <p>02-37265-01</p> 	 <p>08-39572-01</p> 	 <p>04-10378-01 </p> 	 <p>61-37265-00 48 04 896 87 Ø 0,64 mm MLS</p> 	 <p>14-32169-01 607 208 (10x)</p> 	 <p>15-11037-01 12 593 309</p> 	 <p>12-34264-01 642 501 (16x)</p>  <p>70-34264-00 642 501</p>  <p>16x</p>	 <p>71-38154-00  48 04 952</p>  <p>71-39351-00  48 13 565</p> 	 <p>70-31414-10 </p>	 <p>81-33489-10  20 91 167 42x55 RD FPM</p>  <p>81-38229-00  614 827 90x104 A SL LD</p> 

OPEL/VAUXHALL													
Ltr.													
2,0 B 20 DTH B 20 DTJ D 20 DTH D 20 DTJ	96-128 kW (130-174 PS) ANTARA CDTI CASCADA CDTI INSIGNIA B CDTI INSIGNIA CDTI ZAFIRA CDTI ZAFIRA III CDTI	10/11		02-10024-01 	08-10030-01 		61-10133-00 55 486 848 84,5 Ø 1,1 mm MLS 61-10133-10 55 486 849 84,5 Ø 1,2 mm MLS 61-10133-20 55 486 850 84,5 Ø 1,3 mm MLS	14-11654-01 55 580 108 (10X) 	71-11531-00 55 578 302 	12-11648-01 55 491 743 (16X) 	71-11532-00 55 580 111 71-42113-00 55 486 632 	70-31414-10 	81-10462-00 20 91 158 31x41 RD FPM 81-10455-00 55 485 582 93x172,5 Gummi 81-10539-00 N 55 580 121 24x45 RD FPM
2,0 B 20 NFT B 20 NHT D 20 NFT	184-191 kW (250-260 PS) INSIGNIA INSIGNIA CDTI INSIGNIA Turbo INSIGNIA Turbo	07/11 [NEW]		02-10311-02 	08-12870-01 	04-10378-01 	61-10311-00 12 629 404 88 Ø 1,1 mm MLS 	14-10029-01 11 610 687 (10X) 	15-10120-01 	12-10016-01 12 653 350 (8X) 70-13384-00 12 653 350 8x 70-38226-00 642 688 8x 	71-13377-00 12 655 276 71-13376-00 12 657 167 	70-31414-10 	81-10509-00 12 626 923 44,8x61 RD FPM 81-38229-00 614 827 90x104 A SL LD 81-10459-00 N 12 638 690 37x54 FPM











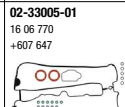
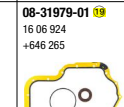
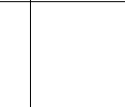
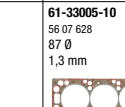
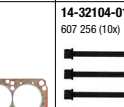
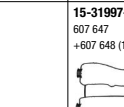
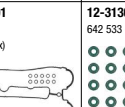
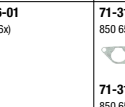
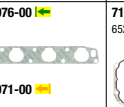

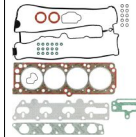

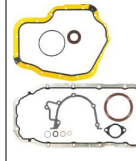

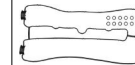









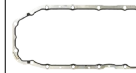

OPEL/VAUXHALL													
Ltr.													
2,0 C 20 LET	150 kW (204 PS) CALIBRA A Turbo CALIBRA Turbo CAVALIER III Turbo VECTRA A Turbo	08/91-07/97											
				02-34210-01 16 06 750 +636 841 (2x) 	08-13054-02 16 06 688 	61-34210-00 608 815 87,5 Ø 1,2 mm 	14-32040-01 607 248 (10x) 14-32104-01 607 256 (10x) 	71-28233-00 607 643 	12-26546-02 642 527 (16x) 70-26546-00 642 527 	71-28234-00 850 606 71-28859-00 850 646 	71-13054-10 2x 652 599 	81-28236-00 646 269 38x50 A SL RD FPM 81-38229-00 614 827 90x104 A SL LD 81-24909-10 2x 56 36 970 35x48 A SL RD MVQ 	
2,0 C 20 NE C 20 NEF C 20 NEJ C 20 SE C 20 SEH	73-95 kW (99-130 PS) ASCONA C ASTRA F ASTRA II ASTRA III CALIBRA CALIBRA A CARLTON II CARLTON III CAVALIER CAVALIER II CAVALIER III KADETT CC KADETT E OMEGA A REKORD E VECTRA A VECTRA B	10/78-04/02		02-26775-02 16 06 664 +642 527 (8x) 	08-27293-02 16 06 663 	61-26775-10 607 987 87,5 Ø 1,3 mm 	14-32037-01 607 685 (10x) 	71-13045-30 638 192 	12-26546-01 642 527 (8x) 70-26546-00 642 527 	71-26510-10 850 601 71-25513-10 850 645 71-25865-00 854 933 	71-27293-00 652 587 	81-25516-10 646 265 31x50 A SL RD FPM 81-38229-00 614 827 90x104 A SL LD 81-24909-10 56 36 970 35x48 A SL RD MVQ 81-27317-00 636 839 55x70,1 AB LD FPM 	

OPEL/VAUXHALL

Ltr.  2,0 C 20 NE  85 kW (115 PS) FRONTERA FRONTERA A  03/92-10/98 **1**























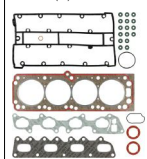

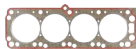

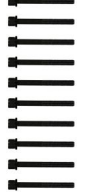



















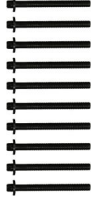

											
	<p>02-26775-02 16 06 664 +642 527 (8x)</p> 	<p>08-31965-02 16 06 787</p> 		<p>61-26775-10 607 987 87,5 Ø 1,3 mm</p> 	<p>14-32037-01 607 685 (10x)</p> 	<p>71-13045-30 638 192</p> 	<p>12-26546-01 642 527 (8x)</p>  <p>70-26546-00 642 527</p> 	<p>71-26510-10 </p> <p>646 265 850 601</p>  <p>71-25513-10 </p> <p>850 645</p>  <p>71-25865-00  </p> <p>854 933</p> 	<p>71-13054-10 652 599</p> 	<p>81-25516-10 </p> <p>646 265 31x50 A SL RD FPM</p>  <p>81-38229-00 </p> <p>614 827 90x104 A SL LD</p>  <p>81-24909-10 </p> <p>56 36 970 35x48 A SL RD MVQ</p>  <p>81-27317-00 </p> <p>636 839 55x70,1 AB LD FPM</p> 	

2,0 C 20 SEL 85-100 kW (116-136 PS) VECTRA B 09/95-07/03

											
	<p>02-33005-01 16 06 770 +607 647</p> 	<p>08-31979-01 </p> <p>16 06 924 +646 265</p> 		<p>61-33005-10 56 07 628 87 Ø 1,3 mm</p> 	<p>14-32104-01 607 256 (10x)</p> 	<p>15-31997-01 607 647 +607 648 (10x)</p>  <p>71-31997-00 607 647</p> 	<p>12-31306-01 642 533 (16x)</p>  <p>70-31306-10 642 533</p> 	<p>71-31976-10 </p> <p>850 655</p>  <p>71-31971-00 </p> <p>850 656</p>  <p>71-25865-00  </p> <p>854 933</p> 	<p>71-31979-00 </p> <p>652 635</p>  <p>71-31978-00  </p> <p>652 636</p> 	<p>81-25516-10 </p> <p>646 265 31x50 A SL RD FPM</p>  <p>81-38229-00 </p> <p>614 827 90x104 A SL LD</p>  <p>81-24909-10 </p> <p>56 36 970 35x48 A SL RD MVQ</p> 	

















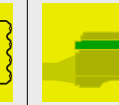
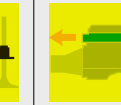
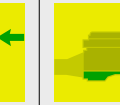







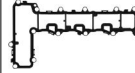











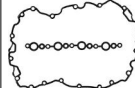









2x

OPEL/VAUXHALL

<p>Ltr. </p>		<p>1</p>											
<p>2,0 C 20 XE 20 XE 20 XEJ</p>	<p>110-115 kW (150-156 PS)</p>	<p>12/87-02/98</p>	<p>02-28235-01 16 06 687 +642 527 (16x) +636 841 (2x)</p> 	<p>08-13054-02 16 06 688</p> 		<p>61-28235-10 607 983 87,5 Ø 1,29 mm</p> 	<p>14-32040-01 607 248 (10x) → 14137011</p>  <p>14-32104-01 607 256 (10x) → 14137012→</p> 	<p>71-28233-00 607 643</p> 	<p>12-26546-01 642 527 (8x)</p>  <p>70-26546-00 642 527</p> 	<p>71-28234-00  1 850 606</p>  <p>71-28859-00  1 850 646</p> 	<p>71-13054-10 2x 652 599</p> 	<p>81-28236-00  1 646 269 38x50 A SL RD FPM</p>  <p>81-38229-00  1 614 827 90x104 A SL LD</p>  <p>81-24909-10 N 2x 56 36 970 35x48 A SL RD MVQ</p> 	
<p>2,0 D 20 DTH (DW10FC)</p>	<p>130 kW (177 PS)</p>	<p>10/17</p>	<p>02-12453-01</p> 	<p>08-12456-01</p> 	<p>04-10350-01  1</p> 	<p>61-10212-00 35 53 124 86 Ø 1,25 mm MLS</p>  <p>61-10212-10 36 48 401 86 Ø 1,3 mm MLS</p>  <p>61-10212-20 36 48 402 86 Ø 1,35 mm MLS</p>  <p>61-10212-30 36 48 403 86 Ø 1,4 mm MLS</p>  	<p>14-12457-01 35 52 936 (10x)</p> 	<p>71-12453-00 36 48 405</p> 	<p>12-38539-01 35 52 968 (16x)</p>  <p>70-38539-00 16x</p> 	<p>71-12455-00  1 35 53 035</p> 	<p>71-12456-00 36 48 409</p> 	<p>81-36557-00  1 39 166 040 42x62 A SL RD PTFE</p>  <p>81-36556-00  1 35 53 064 90x110 A SL LD PTFE</p> 	



























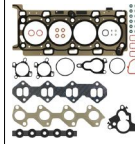



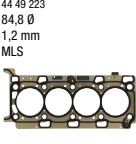

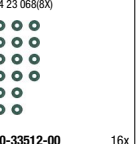
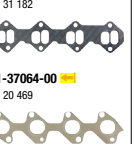









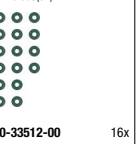
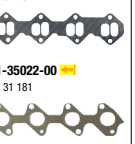



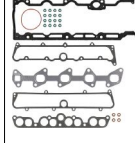

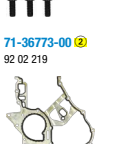

OPEL/VAUXHALL

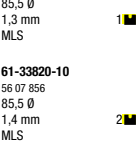
Ltr.	Motor	Power	Model	Year	Image 1	Image 2	Image 3	Image 4	Image 5	Image 6	Image 7	Image 8	Image 9	Image 10	Image 11
2,0	D 20 DTH (DW10FD) D 20 DTL (DW10FE) DW10FDDU340 DW10FDDU370	90-110 kW (122-150 PS)	VIVARO CDTI ZAFIRA	03/19											
					02-12453-01 	08-12456-01 	04-10350-01	61-10212-00 35 53 124 86 Ø 1,25 mm MLS 1 1 61-10212-10 36 48 401 86 Ø 1,3 mm MLS 2 2 61-10212-20 36 48 402 86 Ø 1,35 mm MLS 3 3 61-10212-30 36 48 403 86 Ø 1,4 mm MLS 4 4	14-12457-01 35 52 936 (10X) 	71-12453-00 36 48 405 	12-38539-01 35 52 968 (16X) 70-38539-00 16x 	71-12455-00 35 53 035 	70-31414-10 71-12456-00 36 48 409 	81-36557-00 39 166 040 42x62 A SL RD PTFE 81-36556-00 35 53 064 90x110 A SL LD PTFE 81-34144-00 35 52 931 27x47 A SL RD FPM 	
2,0	D 20 DTR	154 kW (209-210 PS)	INSIGNIA CDTI	03/17				61-10847-00 55489360 84,5 Ø 1,1 mm MLS 61-10847-10 55489361 84,5 Ø 1,2 mm MLS 	14-11654-01 55 580 108 (10X) 	71-11531-00 55 578 302 	12-11648-01 55 491 743 (16X) 	71-11532-00 55 580 111 71-12265-00 55588799 	70-31414-10 	81-10462-00 20 91 158 31x41 RD FPM 81-10455-00 55 485 582 93x172,5 Gummi 81-10539-00 55 580 121 24x45 RD FPM 	

OPEL/VAUXHALL															
Ltr. 															
2,0 D 20 DTR (DW10FDCU)	130 kW (177 PS)	VIVARO CDTI ZAFIRA	03/19						<p>61-10212-00 35 53 124 86 Ø 1,25 mm MLS</p> <p>61-10212-10 36 48 401 86 Ø 1,3 mm MLS</p> <p>61-10212-20 36 48 402 86 Ø 1,35 mm MLS</p> <p>61-10212-30 36 48 403 86 Ø 1,4 mm MLS</p> 	<p>14-12457-01 35 52 936 (10X)</p> 	<p>71-12453-00 36 48 405</p> 	<p>12-38539-01 35 52 968 (16X)</p> <p>70-38539-00 16x</p> 	<p>71-12455-00 </p> <p>35 53 035</p> 	<p>70-31414-10 </p>  <p>71-12456-00 36 48 409</p> 	<p>81-36557-00 K </p> <p>39 166 040 42x62 A SL RD PTFE</p>  <p>81-36556-00 K </p> <p>35 53 064 90x110 A SL LD PTFE</p>  <p>81-34144-00 N</p> <p>35 52 931 27x47 A SL RD FPM</p> 
2,0 D 20 DVH F 20 DVH F20DVH	128 kW (174 PS)	INSIGNIA INSIGNIA B INSIGNIA B CDTI	02/20 [NEW]						<p>61-11222-00 55 495 681 84 Ø 1,35 mm MLS</p> <p>61-11222-10 55 495 682 84 Ø 1,45 mm MLS</p> <p>61-11222-20 55 495 683 84 Ø 1,55 mm MLS</p>	<p>14-18424-02 55 490 324 (10X)</p>	<p>15-11219-01 55 511 791</p> 	<p>12-18427-02 55 484 799 (16X)</p> <p>70-18427-00 16x</p> 	<p>71-20916-00 </p> <p>55 495 727</p>  <p>71-13458-00 </p> <p>55 495 913</p>	<p>70-31414-10 </p> 	<p>81-10667-00 K </p> <p>55 495 914 Gummi/Metall</p>  <p>81-10668-00 K </p> <p>55 495 880 Gummi/Metall</p> 
2,0 F20SHL F20SHT	125-169 kW (170-230 PS)	INSIGNIA INSIGNIA B	04/20 [NEW]						<p>61-11221-00 55 495 594 84 Ø MLS</p>	<p>14-20892-01 55 488 687 (10X)</p>	<p>71-20889-00 55 488 236</p>	<p>12-20907-01 55 490 062 (8X)</p>	<p>71-20915-00 </p> <p>55 488 180</p>  <p>11-20920-01 </p> 	<p>70-31414-10 </p> 	<p>81-10665-00 K </p> <p>PTFE</p> <p>81-10666-00 K </p> <p>55 486 914 PTFE</p> 

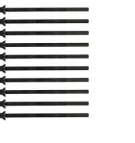
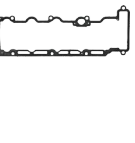
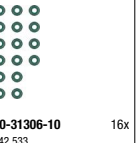
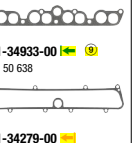
OPEL/VAUXHALL														
Ltr.				1										
2,0	F4R 720	88 kW (120 PS)	VIVARO	08/01-07/14										
					02-31655-01 44 09 999	08-34414-01 44 10 000		61-31655-00 84 Ø 0,65 mm MLS	14-32154-01 44 09 151	70-31414-10	12-34406-01 44 09 126 (16x)	71-33147-00 44 10 375	71-34414-00 44 02 981	81-34413-00 44 02 706 42x54 A SL RD FPM/ACM 81-23708-50 44 04 963 85x105 A SL LD FPM 81-34472-00 N 44 09 866 28x47 A SL RD FPM
											70-34406-00 44 09 126	71-33148-00 44 09 359		81-34472-00 N 44 09 866 28x47 A SL RD FPM
2,0	F4R 820	86 kW (117 PS)	VIVARO	08/06-07/14										
					02-31655-01 44 09 999	08-34414-04 44 31 983		61-31655-00 84 Ø 0,65 mm MLS	14-32154-01 44 09 151	70-31414-10	12-34406-01 44 09 126 (16x)	71-33513-00 44 10 375	70-31414-10	81-34413-00 44 02 706 42x54 A SL RD FPM/ACM 81-34417-10 44 04 963 85x105 A SL LD FPM 81-34472-00 N 44 09 866 28x47 A SL RD FPM
											71-31912-00 44 02 981	70-34406-00 44 09 126		81-34472-00 N 44 09 866 28x47 A SL RD FPM
2,0	H 20 E 20 E 20 EH	81-85 kW (110-115 PS)	ASCONA B CARLTON II KADETT C MANTA B MONZA A REKORD E SENATOR SENATOR A	08/77-08/88										
					02-26255-06 16 06 718 +642 530 (4x)	08-12841-06 16 06 598 +614 815		61-26255-10 607 971 +638 182 97 Ø 1 mm	14-32039-01 20 24 152 (5x) +20 24 153 (5x) 20E0339282→	71-12944-00 607 664	12-27431-02 642 452 (4x) +642 530 (4x)	71-20654-10 850 619	10-12841-02 16 06 230	81-19195-00 638 187 45x60 A SL RD ACM 81-20667-30 90 156 857 77x100 A SL LD FPM
											40-77344-00 AS 642 452	71-23862-10 854 841		70-27431-00 ES 642 530

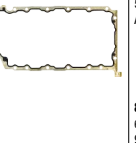
OPEL/VAUXHALL







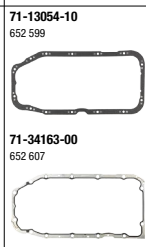
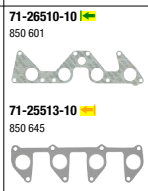
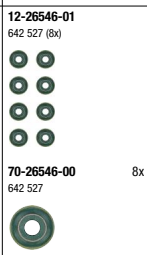
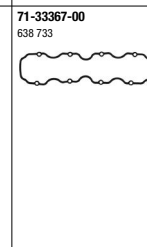
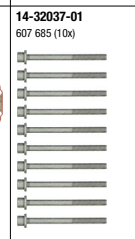
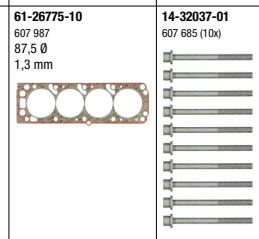
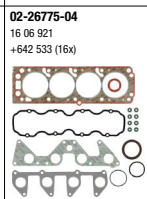
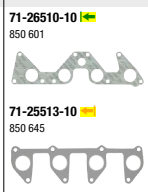
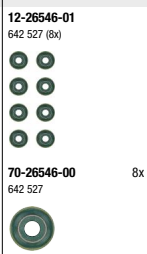
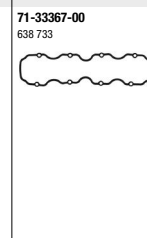
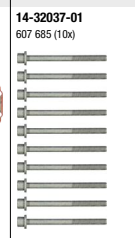
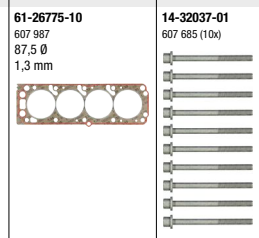

















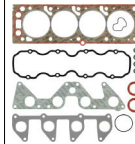

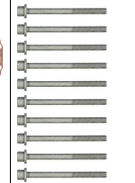

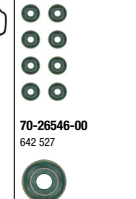



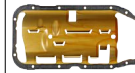







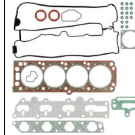
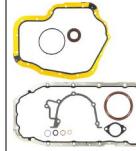
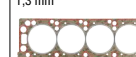











<p>Ltr.   </p> <p>2,0 LNF Z 20 NHH</p> <p>194 kW (264 PS) GT</p> <p>06/07</p>					 61-37265-00 48 04 896 87 Ø 0,64 mm MLS	 14-32169-01 607 208 (10x)		 12-34264-01 642 501 (16x)	 71-38154-00  48 04 952	 70-31414-10	 81-38229-00  614 827 90x104 A SL LD
<p>2,0 M9R 630 M9R 692</p> <p>66-84 kW (90-114 PS) VIVARO CDTI</p> <p>01/06-07/14</p>		 08-38518-01 93 168 364	 04-10288-01 	 61-37375-10 44 49 223 84,8 Ø 1,2 mm MLS		 70-31414-10	 12-33512-02 44 23 068(8X)	 71-35023-00  44 31 182	 70-31414-10	 81-38518-00  93 161 608 50x81 RD PTFE ACM	
<p>2,0 M9R 780 M9R 782 M9R 784 M9R 786 M9R 788</p> <p>66-84 kW (90-114 PS) VIVARO CDTI</p> <p>01/06-07/14</p>		 08-38518-01 93 168 364		 61-37375-10 44 49 223 84,8 Ø 1,2 mm MLS	 14-32231-01 44 04 240 (10x)	 15-38621-01 44 31 138	 12-33512-02 44 23 068(8X)	 71-35023-00  44 31 182	 70-31414-10	 81-38518-00  93 161 608 50x81 RD PTFE ACM	
<p>2,0 X 20 DTH X 20 DTL</p> <p>60-74 kW (82-101 PS) ASTRA G DI ASTRA IV DI OMEGA B DTI OMEGA DTI VECTRA B DI VECTRA B DTI VECTRA DI VECTRA DTI VECTRA DTI ZAFIRA DI</p> <p>08/95-08/06 (NEW)</p>		 08-34164-01 16 06 399	 04-10190-01   71-36773-00  92 02 219	 61-33820-00 5607421 85,5 Ø 1,3 mm MLS  61-33820-10 56 07 856 85,5 Ø 1,4 mm MLS  61-33820-20 56 07 630 85,5 Ø 1,5 mm MLS 	 14-32105-01 607 923 (10x)	 71-34277-00 56 07 442	 12-31306-01 642 533 (16x)	 71-34286-00  849 193	 71-34164-00 652 605	 81-35723-00  638 196 55x88 AB SL RD FPM	

OPEL/VAUXHALL





















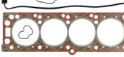









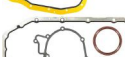



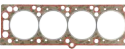

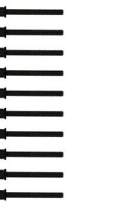

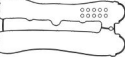
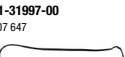



















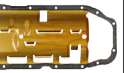

















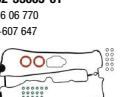
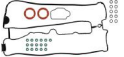









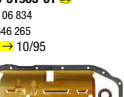









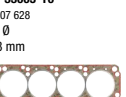
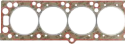
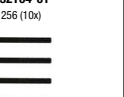

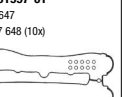



















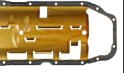





Ltr.	2,0 X 20 SE	85 kW (115 PS)	FRONTERA	03/92-10/98														
1	2,0 X 20 SE	85 kW (115 PS)	FRONTERA	03/92-10/98														
2,0 X 20 SE	85 kW (115 PS)	FRONTERA A	03/92-10/98															

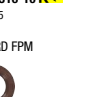

OPEL/VAUXHALL

Ltr. 	2,0 X 20 SE	85 kW (115-116 PS)	OMEGA OMEGA B	 03/94-09/99											
2,0 X 20 SE	85 kW (115-116 PS)	OMEGA OMEGA B	 03/94-09/99	<p>02-26775-03 16 06 823 +638 733 +642 527 (8x)</p> 	<p>08-31965-01 16 06 834 +646 265</p> 		<p>61-26775-10 607 987 87,5 Ø 1,3 mm</p> 	<p>14-32037-01 607 685 (10x)</p> 	<p>71-33367-00 638 733</p> 	<p>12-26546-01 642 527 (8x)</p> 	<p>71-26510-10 </p> <p>850 601</p> 	<p>71-25513-10 </p> <p>850 645</p> <p>8x </p>	<p>71-31965-00 652 274</p> 	<p>81-25516-10 </p> <p>646 265 31x50 A SL RD FPM</p>  <p>81-38229-00 </p> <p>614 827 90x104 A SL LD</p>  <p>81-24909-10 </p> <p>56 36 970 35x48 A SL RD MVQ</p> 	
2,0 X 20 XER	118 kW (160 PS)	ASTRA G	 11/99-09/02	<p>02-33005-03 16 06 098 +56 07 449</p> 	<p>08-31979-01 16 06 924 +646 265</p> 		<p>61-33005-10 56 07 628 87 Ø 1,3 mm</p> 	<p>14-32104-01 607 256 (10x)</p> 	<p>15-31997-01 607 647 +607 648 (10x)</p>  <p>71-31997-00 607 647</p> 	<p>12-31306-01 642 533 (16x)</p>  <p>70-31306-10 642 533</p> 	<p>71-31976-00 </p> <p>850 655</p>  <p>71-31971-00 </p> <p>850 656</p>  <p>71-25865-00  </p> <p>854 933</p> 	<p>71-31979-00 652 635</p>  <p>71-31978-00 </p> <p>652 636</p> 	<p>81-25516-10 </p> <p>646 265 31x50 A SL RD FPM</p>  <p>81-38229-00 </p> <p>614 827 90x104 A SL LD</p>  <p>81-24909-10 </p> <p>56 36 970 35x48 A SL RD MVQ</p> 		

























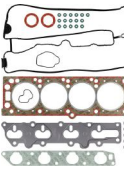





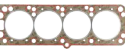



























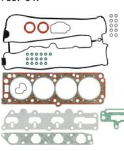







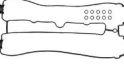













OPEL/VAUXHALL

<p>Ltr.  2,0 X 20 XEV</p> <p>100 kW (136 PS)</p> <p> ASTRA F ASTRA III OMEGA OMEGA B</p> <p> 1</p> <p>01/94-07/01</p>		 <p>02-33005-01 16 06 770 +607 647  01/98</p>   <p>02-33005-04 16 06 552  02/98→</p>   	 <p>08-31965-01   16 06 834 +646 265  10/95</p>   <p>08-31979-01  16 06 924 +646 265  11/95→</p>   		 <p>61-33005-10 56 07 628 87 Ø 1,3 mm</p> 	 <p>14-32104-01 607 256 (10x)</p> 	 <p>15-31997-01 607 647 +607 648 (10x)</p>  <p>71-31997-00 607 647</p> 	 <p>12-31306-01 642 533 (16x)</p>  <p>70-31306-10 642 533</p> 	 <p>71-31976-00   850 655</p>  <p>71-31971-00  850 656  01/98</p>  <p>71-34278-00  849 934  02/98→</p>  <p>71-25865-00   854 933</p> 	 <p>71-31965-00  652 274  10/95</p>  <p>71-31979-00  652 635  11/95→</p>  <p>71-31978-00   652 636  11/95→</p> 	 <p>81-25516-10   646 265 31x50 A SL RD FPM</p>  <p>81-38229-00  614 827 90x104 A SL LD</p>  <p>81-24909-10   2x 56 36 970 35x48 A SL RD MVQ</p> 
<p>2,0 X 20 XEV</p> <p>100 kW (136 PS)</p> <p> ASTRA F CALIBRA</p> <p>06/90-01/98</p>		 <p>02-33005-01 16 06 770 +607 647</p>   <p>08-31965-01   16 06 834 +646 265  10/95</p>   <p>08-31979-01  16 06 924 +646 265  11/95→</p>  	 <p>08-31965-01   16 06 834 +646 265  10/95</p>   <p>08-31979-01  16 06 924 +646 265  11/95→</p>  		 <p>61-33005-10 56 07 628 87 Ø 1,3 mm</p> 	 <p>14-32104-01 607 256 (10x)</p> 	 <p>15-31997-01 607 647 +607 648 (10x)</p>  <p>71-31997-00 607 647</p> 	 <p>12-31306-01 642 533 (16x)</p>  <p>70-31306-10 642 533</p> 	 <p>71-31976-00   850 655</p>  <p>71-31971-00  850 656</p>  <p>71-34278-00  849 934</p>  <p>71-25865-00   854 933</p> 	 <p>71-31965-00  652 274  10/95</p>  <p>71-31979-00  652 635  11/95→</p>  <p>71-31978-00   652 636  11/95→</p> 	 <p>81-25516-10   646 265 31x50 A SL RD FPM</p>  <p>81-38229-00  614 827 90x104 A SL LD</p>  <p>81-24909-10   2x 56 36 970 35x48 A SL RD MVQ</p> 

OPEL/VAUXHALL













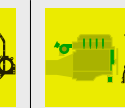

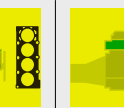

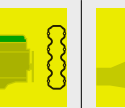
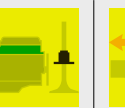
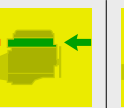

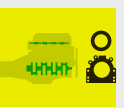
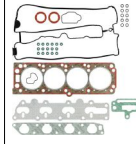
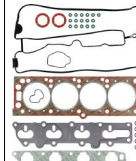





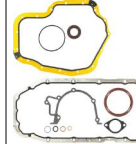

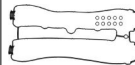













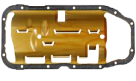





Ltr.	Engine	Power	Models	Year	Image 1	Image 2	Image 3	Image 4	Image 5	Image 6	Image 7	Image 8	Image 9	Image 10	Image 11	Image 12
2,0	X 20 XEV	100 kW (136 PS)	ASTRA G ASTRA IV OMEGA VECTRA	02/98-05/05												
						<p>02-33005-04 16 06 552</p>	<p>08-31979-01 </p> <p>16 06 924 +646 265</p>		<p>61-33005-10 56 07 628 87 Ø 1,3 mm</p>	<p>14-32104-01 607 256 (10x)</p>	<p>15-31997-01 607 647 +607 648 (10x)</p>	<p>12-31306-01 642 533 (16x)</p>	<p>71-31976-00 </p> <p>850 655</p>	<p>71-31979-00 </p> <p>652 635</p>	<p>81-25516-10 </p> <p>646 265 31x50 A SL RD FPM</p>	
											<p>71-34278-00 </p> <p>849 934</p>	<p>71-31978-00 </p> <p>652 636</p>	<p>81-38229-00 </p> <p>614 827 90x104 A SL LD</p>	<p>81-24909-10 </p> <p>56 36 970 35x48 A SL RD MVQ</p>	2x	
2,0	X 20 XEV	100 kW (136 PS)	ASTRA III	02/95-09/98												
						<p>02-33005-01 16 06 770 +607 647 </p>	<p>08-31965-01 </p> <p>16 06 834 +646 265 </p>		<p>61-33005-10 56 07 628 87 Ø 1,3 mm</p>	<p>14-32104-01 607 256 (10x)</p>	<p>15-31997-01 607 647 +607 648 (10x)</p>	<p>12-31306-01 642 533 (16x)</p>	<p>71-31976-00 </p> <p>850 655</p>	<p>71-31965-00 </p> <p>652 674 </p>	<p>81-25516-10 </p> <p>646 265 31x50 A SL RD FPM</p>	
						<p>02-33005-04 16 06 552 </p>	<p>08-31979-01 </p> <p>16 06 924 +646 265 </p>				<p>71-31971-00 </p> <p>850 656 </p>	<p>71-31979-00 </p> <p>652 635 </p>	<p>81-38229-00 </p> <p>614 827 90x104 A SL LD</p>	<p>81-24909-10 </p> <p>56 36 970 35x48 A SL RD MVQ</p>	2x	
											<p>71-34278-00 </p> <p>849 934 </p>	<p>71-31978-00 </p> <p>652 636 </p>	<p>81-38229-00 </p> <p>614 827 90x104 A SL LD</p>	<p>81-24909-10 </p> <p>56 36 970 35x48 A SL RD MVQ</p>	2x	

OPEL/VAUXHALL











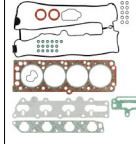



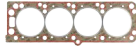

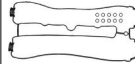













Ltr. 	2,0 X 20 XEV	100 kW (136 PS)	 CALIBRA A	 02/94-07/97																			
2,0 X 20 XEV	100 kW (136 PS)	CALIBRA A		02/94-07/97	<p>02-33005-04 16 06 552</p> 	<p>08-31965-01 </p> <p>16 06 834 +646 265  10/95</p> 	<p>08-31979-01 </p> <p>16 06 924 +646 265  11/95 →</p> 		<p>61-33005-10 56 07 628 87 Ø 1,3 mm</p> 	<p>14-32104-01 607 256 (10x)</p> 	<p>15-31997-01 607 647 +607 648 (10x)</p> 	<p>71-31997-00 607 647</p> 	<p>12-31306-01 642 533 (16x)</p> 	<p>70-31306-10 642 533</p> 	<p>71-31976-10 </p> <p>850 655</p> 	<p>71-31971-00 </p> <p>850 656</p> 	<p>71-25865-00  </p> <p>854 933</p> 	<p>71-31965-00 </p> <p>652 274  10/95</p> 	<p>71-31979-00 </p> <p>652 635  11/95 →</p> 	<p>71-31978-00  </p> <p>652 636  11/95 →</p> 	<p>81-25516-10 </p> <p>646 265 31x50 A SL RD FPM</p> 	<p>81-38229-00 </p> <p>614 827 90x104 A SL LD</p> 	<p>81-24909-10 </p> <p>56 36 970 35x48 A SL RD MVQ</p> 
2,0 X 20 XEV	100 kW (136 PS)	CAVALIER III		09/92-08/95	<p>02-33005-01 16 06 770 +607 647</p> 	<p>08-31965-01 </p> <p>16 06 834 +646 265</p> 	<p>08-31979-01 </p> <p>16 06 924 +646 265  11/95 →</p> 		<p>61-33005-10 56 07 628 87 Ø 1,3 mm</p> 	<p>14-32104-01 607 256 (10x)</p> 	<p>15-31997-01 607 647 +607 648 (10x)</p> 	<p>71-31997-00 607 647</p> 	<p>12-31306-01 642 533 (16x)</p> 	<p>70-31306-10 642 533</p> 	<p>71-31976-10 </p> <p>850 655</p> 	<p>71-31971-00 </p> <p>850 656</p> 	<p>71-25865-00  </p> <p>854 933</p> 	<p>71-31965-00 </p> <p>652 274</p> 	<p>71-31979-00  </p> <p>652 636</p> 	<p>71-31978-00  </p> <p>652 636</p> 	<p>81-25516-10 </p> <p>646 265 31x50 A SL RD FPM</p> 	<p>81-38229-00 </p> <p>614 827 90x104 A SL LD</p> 	<p>81-24909-10 </p> <p>56 36 970 35x48 A SL RD MVQ</p> 

OPEL/VAUXHALL

Ltr.  2,0 X 20 XEV  100 kW (136 PS) VECTRA  1 10/95-01/01













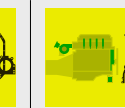

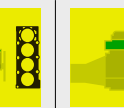

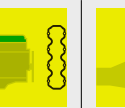
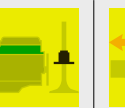
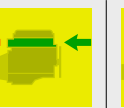

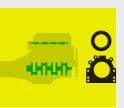
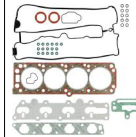



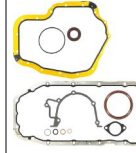



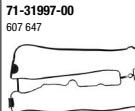











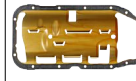

											
	<p>02-33005-01 16 06 770 +607 647 1 → 01/98</p>  <p>02-33005-04 16 06 552 1 → 01/98 →</p> 	<p>08-31965-01  16 06 834 +646 265 1 → 10/95</p>  <p>08-31979-01  16 06 924 +646 265 1 → 11/95 →</p>  <p>08-31979-01  16 06 924 +646 265</p> 		<p>61-33005-10 56 07 628 87 Ø 1,3 mm</p> 	<p>14-32104-01 607 256 (10x)</p> 	<p>15-31997-01 607 647 +607 648 (10x)</p>  <p>71-31997-00 607 647</p> 	<p>12-31306-01 642 533 (16x)</p>  <p>70-31306-10 642 533</p> 	<p>71-31976-00  850 655</p>  <p>71-31971-00  850 656 1 → 01/98</p>  <p>71-34278-00  849 934 1 → 01/98 →</p>  <p>71-25865-00   854 933</p> 	<p>71-31965-00  652 274 1 → 10/95</p>  <p>71-31979-00  652 635 1 → 11/95 →</p>  <p>71-31979-00  652 635</p>  <p>71-31978-00   652 636 1 → 11/95 →</p>  <p>71-31978-00   652 636</p> 	<p>81-25516-10  646 265 31x50 A SL RD FPM</p>  <p>81-38229-00  614 827 90x104 A SL LD</p>  <p>81-24909-10  N 2x 56 36 970 35x48 A SL RD MVQ</p> 	

2,0 X 20 XEV 100 kW (136 PS) VECTRA A 08/92-08/95











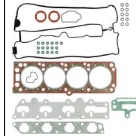

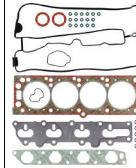

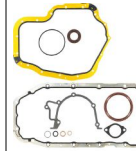

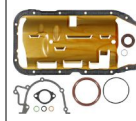
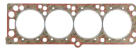





















	<p>02-33005-01 16 06 770 +607 647</p> 	<p>08-31965-01  16 06 834 +646 265</p>  <p>08-31979-01  16 06 924 +646 265</p> 		<p>61-33005-10 56 07 628 87 Ø 1,3 mm</p> 	<p>14-32104-01 607 256 (10x)</p> 	<p>15-31997-01 607 647 +607 648 (10x)</p>  <p>71-31997-00 607 647</p> 	<p>12-31306-01 642 533 (16x)</p>  <p>70-31306-10 642 533</p> 	<p>71-31976-00  850 655</p>  <p>71-31971-00  850 656</p>  <p>71-25865-00   854 933</p> 	<p>71-31965-00  652 274</p>  <p>71-31979-00  652 635</p>  <p>71-31978-00   652 636</p> 	<p>81-25516-10  646 265 31x50 A SL RD FPM</p>  <p>81-38229-00  614 827 90x104 A SL LD</p>  <p>81-24909-10  N 2x 56 36 970 35x48 A SL RD MVQ</p> 
--	--	---	--	---	---	--	---	---	---	--

OPEL/VAUXHALL























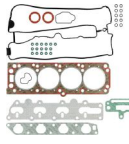
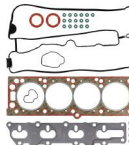



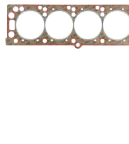
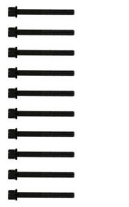





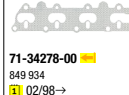

















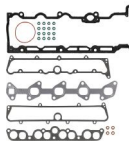



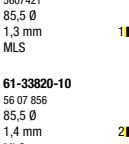
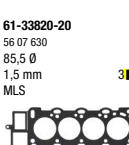
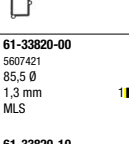

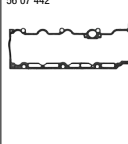

















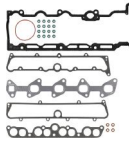





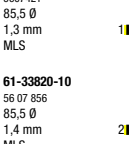
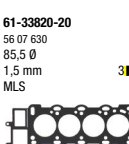

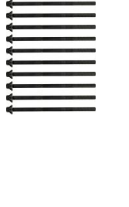
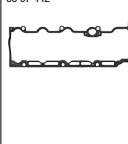
Ltr.  2,0 X 20 XEV  100 kW (136 PS) VECTRA A  06/94-11/95

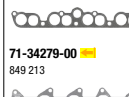
											
	<p>02-33005-01 16 06 770 +607 647</p> 	<p>08-31965-01  16 06 834 +646 265  10/95</p>  <p>08-31979-01  16 06 924 +646 265</p> 		<p>61-33005-10 56 07 628 87 Ø 1,3 mm</p> 	<p>14-32104-01 607 256 (10x)</p> 	<p>15-31997-01 607 647 +607 648 (10x)</p>  <p>71-31997-00 607 647</p> 	<p>12-31306-01 642 533 (16x)</p>  <p>70-31306-10 642 533</p> 	<p>71-31976-00  850 655</p>  <p>71-31971-00  850 656</p>  <p>71-25865-00   854 933</p> 	<p>71-31965-00  652 274  10/95</p>  <p>71-31979-00  652 635</p>  <p>71-31978-00   652 636</p> 	<p>81-25516-10  646 265 31x50 A SL RD FPM</p>  <p>81-38229-00  614 827 90x104 A SL LD</p>  <p>81-24909-10  2x 56 36 970 35x48 A SL RD MVQ</p> 	

























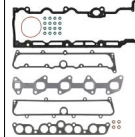









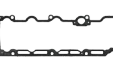













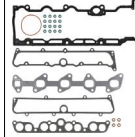

























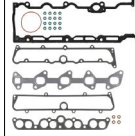











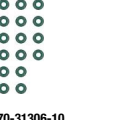

2,0 X 20 XEV 100 kW (136 PS) VECTRA B 09/95-06/00

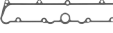
	<p>02-33005-01 16 06 770 +607 647  01/98</p>  <p>02-33005-04 16 06 552  02/98→</p> 	<p>08-31979-01  16 06 924 +646 265  11/95→</p>  <p>08-31965-01  16 06 834 +646 265</p> 		<p>61-33005-10 56 07 628 87 Ø 1,3 mm</p> 	<p>14-32104-01 607 256 (10x)</p> 	<p>15-31997-01 607 647 +607 648 (10x)</p>  <p>71-31997-00 607 647</p> 	<p>12-31306-01 642 533 (16x)</p>  <p>70-31306-10 642 533</p> 	<p>71-31976-00  850 655</p>  <p>71-31971-00  850 656  01/98</p>  <p>71-34278-00  849 934  02/98→</p>  <p>71-25865-00   854 933</p> 	<p>71-31979-00  652 635  11/95→</p>  <p>71-31965-00  652 274</p>  <p>71-31978-00   652 636  11/95→</p> 	<p>81-25516-10  646 265 31x50 A SL RD FPM</p>  <p>81-38229-00  614 827 90x104 A SL LD</p>  <p>81-24909-10  2x 56 36 970 35x48 A SL RD MVQ</p> 
--	--	---	--	---	---	--	---	---	--	---

















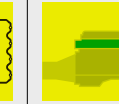
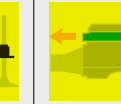
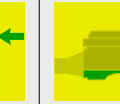









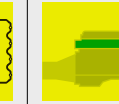
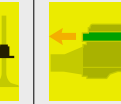
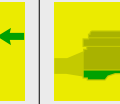

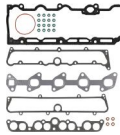

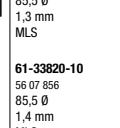
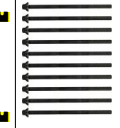
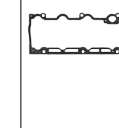
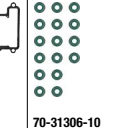
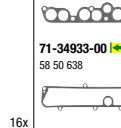
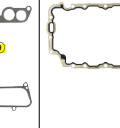







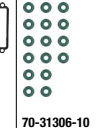



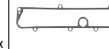







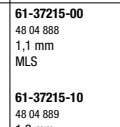
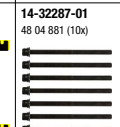
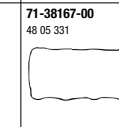
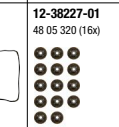
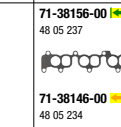

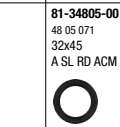





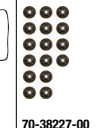











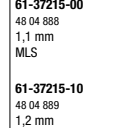
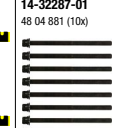
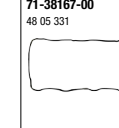
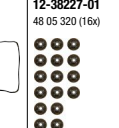
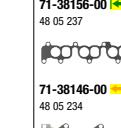
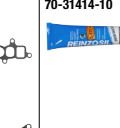
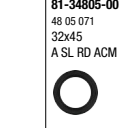



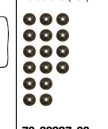

OPEL/VAUXHALL

Ltr. 											
2,0 X 20 XEV 100 kW (136 PS) VECTRA B 11/96-06/00	 02-33005-01 16 06 770 +607 647 1 → 01/98  02-33005-04 16 06 552 1 → 02/98 →	08-31979-01  16 06 924 +646 265  		61-33005-10 56 07 628 87 Ø 1,3 mm 	14-32104-01 607 256 (10x) 	15-31997-01 607 647 +607 648 (10x)  71-31997-00 607 647 	12-31306-01 642 533 (16x)  70-31306-10 642 533 16x	71-31976-00  850 655  71-31971-00  850 656 1 → 01/98  71-34278-00  849 934 1 → 02/98 →  71-25865-00  854 933 	71-31979-00  652 635  71-31978-00  652 636 	81-25516-10  646 265 31x50 A SL RD FPM  81-38229-00  614 827 90x104 A SL LD  81-24909-10  56 36 970 35x48 A SL RD MVQ 	
2,0 Y 20 DTH 74 kW (100-101 PS) ASTRA G DTI  2H999999, ASTRA IV DTI 22-28999999 ZAFIRA DTI  2H999999, 22-28999999  2H999999, 22-28999999	 02-34277-01	08-34164-01 16 06 399 	71-36773-00  92 02 219 	61-33820-00 5607421 85,5 Ø 1,3 mm MLS  61-33820-10 56 07 856 85,5 Ø 1,4 mm MLS  61-33820-20 56 07 630 85,5 Ø 1,5 mm MLS 	14-32105-01 607 923 (10x) 	71-34277-00 56 07 442 	12-31306-01 642 533 (16x)  70-31306-10 642 533 16x	71-34286-00  849 193  71-34933-00  58 50 638  71-34279-00  849 213 	71-34164-00 652 605 	81-35723-00  638 196 55x68 AB SL RD FPM  81-34301-00  614 855 99x114 A LD FPM/ACM 	
2,0 Y 20 DTH 74 kW (100-101 PS) ASTRA G DTI  2H999999, ASTRA G DTI 22999999, 25999999, ASTRA IV DTI 28999999 ASTRA IV DTI  3H000001, 32000001, ZAFIRA DTI 35000001, 38000001 → ZAFIRA DTI  2H999999, 22999999, 25999999, 28999999  3H000001, 32000001, 35000001, 38000001 →  2H999999, 22999999, 25999999, 28999999  3H000001, 32000001, 35000001, 38000001 →	 02-34277-01	08-34164-01 16 06 399 	04-10190-01   71-36773-00  92 02 219 	61-33820-00 5607421 85,5 Ø 1,3 mm MLS  61-33820-10 56 07 856 85,5 Ø 1,4 mm MLS  61-33820-20 56 07 630 85,5 Ø 1,5 mm MLS 	14-32105-01 607 923 (10x) 	71-34277-00 56 07 442 	12-31306-01 642 533 (16x)  70-31306-10 642 533 16x	71-34286-00  849 193  71-34279-00  849 213 	71-34164-00 652 605 	81-35723-00  638 196 55x68 AB SL RD FPM  81-34301-00  614 855 99x114 A LD FPM/ACM 	

OPEL/VAUXHALL

































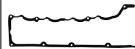

















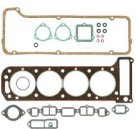
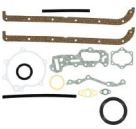









Ltr. 													
2,0 Y 20 DTH 74 kW (100-101 PS) ASTRA G DTI ASTRA IV DTI SIGNUM DTI VECTRA C DTI VECTRA II DTI ZAFIRA DTI 3H000001, 32-3800001→ 3H000001, 32-3800001→ 3H000001, 32-3800001→ 02/98-10/08 [NEW]				02-34277-01 	08-34164-01 16 06 399 	71-36773-00  92 02 219 	61-33820-00 5607421 85,5 Ø 1,3 mm MLS 1  61-33820-10 56 07 856 85,5 Ø 1,4 mm MLS 2  61-33820-20 56 07 630 85,5 Ø 1,5 mm MLS 3  	14-32105-01 607 923 (10x) 	71-34277-00 56 07 442 	12-31306-01 642 533 (16x)  70-31306-10 642 533 16x 	71-34286-00  849 193  71-35319-00  849 521  71-34279-00  849 213 	71-34164-00 652 605 	81-35723-00  638 196 55x68 AB SL RD FPM  81-34301-00  614 855 99x114 A LD FPM/ACM 
2,0 Y 20 DTH 74 kW (101 PS) ASTRA G DTI VECTRA B DTI VECTRA DTI VECTRA DTI 22-28999999 08/95-04/05 [NEW]				02-34277-01 	08-34164-01 16 06 399 	04-10190-01   71-36773-00  92 02 219 	61-33820-00 5607421 85,5 Ø 1,3 mm MLS 1  61-33820-10 56 07 856 85,5 Ø 1,4 mm MLS 2  61-33820-20 56 07 630 85,5 Ø 1,5 mm MLS 3  	14-32105-01 607 923 (10x) 	71-34277-00 56 07 442 	12-31306-01 642 533 (16x)  70-31306-10 642 533 16x 	71-34286-00  849 193  71-34933-00  58 50 638  71-34279-00  849 213 	71-34164-00 652 605 	81-35723-00  638 196 55x68 AB SL RD FPM  81-34301-00  614 855 99x114 A LD FPM/ACM 
2,0 Y 20 DTH 74 kW (101 PS) ASTRA G DTI 32-3800001→ 09/00-04/05 [NEW]				02-34277-01 	08-34164-01 16 06 399 	04-10190-01   71-36773-00  92 02 219 	61-33820-00 5607421 85,5 Ø 1,3 mm MLS 1  61-33820-10 56 07 856 85,5 Ø 1,4 mm MLS 2  61-33820-20 56 07 630 85,5 Ø 1,5 mm MLS 3  	14-32105-01 607 923 (10x) 	71-34277-00 56 07 442 	12-31306-01 642 533 (16x)  70-31306-10 642 533 16x 	71-34286-00  849 193  71-35319-00  849 521  71-34279-00  849 213 	71-34164-00 652 605 	81-35723-00  638 196 55x68 AB SL RD FPM  81-34301-00  614 855 99x114 A LD FPM/ACM 

OPEL/VAUXHALL

OPEL/VAUXHALL													
Ltr.													
2,0	Y 20 DTL	02/98-08/06											
	60 kW (82 PS) ASTRA G DI ASTRA IV DI ZAFIRA DI			02-34277-01	08-34164-01 16 06 399	04-10190-01 	61-33820-00 5607421 85,5 Ø 1,3 mm MLS  61-33820-10 56 07 856 85,5 Ø 1,4 mm MLS  61-33820-20 56 07 630 85,5 Ø 1,5 mm MLS 	14-32105-01 607 923 (10x) 	71-34277-00 56 07 442 	12-31306-01 642 533 (16x) 	71-34286-00  849 193  71-34933-00  58 50 638  71-34279-00  849 213 	71-34164-00 652 605 	81-35723-00  638 196 55x68 AB SL RD FPM  81-34301-00  614 855 99x114 A LD FPM/ACM 
2,0	Z 20 DM	08/06-04/15											
	93 kW (126 PS) ANTARA CDTI						61-37215-00 48 04 888 1,1 mm MLS  61-37215-10 48 04 889 1,2 mm MLS  61-37215-20 48 04 890 1,3 mm MLS 	14-32287-01 48 04 881 (10x) 	71-38167-00 48 05 331 	12-38227-01 48 05 320 (16x) 	71-38156-00  48 05 237  71-38146-00  48 05 234 	70-31414-10 	81-34805-00  48 05 071 32x45 A SL RD ACM  81-38231-00  48 07 977 98x114 A SL LD FPM  81-53441-00 N 48 05 326 36x50 A SL RD NBR 
2,0	Z 20 DM Z 20 DMH Z 20 S	07/06-04/15											
	93-110 kW (127-150 PS) ANTARA ANTARA CDTI		01-10005-01 93 744 254				61-37215-00 48 04 888 1,1 mm MLS  61-37215-10 48 04 889 1,2 mm MLS  61-37215-20 48 04 890 1,3 mm MLS 	14-32287-01 48 04 881 (10x) 	71-38167-00 48 05 331 	12-38227-01 48 05 320 (16x) 	71-38156-00  48 05 237  71-38146-00  48 05 234 	70-31414-10 	81-34805-00  48 05 071 32x45 A SL RD ACM  81-38231-00  48 07 977 98x114 A SL LD FPM  81-53441-00 N 48 05 326 36x50 A SL RD NBR 

























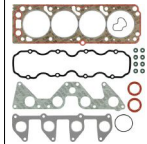

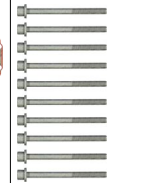

















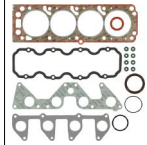

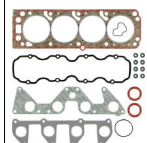





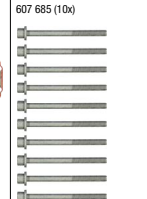



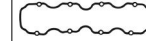
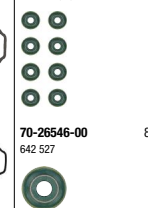



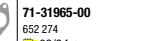

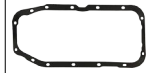
OPEL/VAUXHALL														
Ltr.														
2,0 Z 20 LEH	176-177 kW (240-241 PS)	01/04-11/14	ASTRA ASTRA H Turbo ASTRA V TURBO ZAFIRA ZAFIRA II											
				02-37245-01 16 06 282	08-31979-04 16 06 172	04-10007-01	61-37245-00 56 07 891 87,5 Ø MLS	14-32104-01 607 256 (10x)	15-31997-01 607 647 +607 648 (10x)	12-31306-01 642 533 (16x)	71-31976-00	71-31979-00 652 635	81-25516-10	81-25516-10
											71-35321-00	71-31978-00	81-38229-00	81-38229-00
											70-31306-00 642 533	652 636	614 827 90x104 A SL LD	81-24909-10
											16x		56 36 970 35x48 A SL RD MVQ	
2,0 Z 20 LEL Z 20 LER Z 20 LET	125-162 kW (170-220 PS)	09/00-11/14	ASTRA G Turbo ASTRA H Turbo ASTRA IV ASTRA IV Turbo ASTRA Turbo ASTRA TwinTop ASTRA V Turbo ASTRA V TURBO SPEEDSTER Turbo VX220 Cabriolet VX220 Turbo ZAFIRA ZAFIRA II ZAFIRA Turbo											
				02-34435-01 93 172 424	08-31979-04 16 06 172	04-10007-01	61-34435-00 93 180 271 87,5 Ø 1,2 mm MLS	14-32104-01 607 256 (10x)	15-31997-01 607 647 +607 648 (10x)	12-31306-01 642 533 (16x)	71-31976-00	71-31979-00 652 635	81-25516-10	81-25516-10
											71-35321-00	71-31978-00	81-38229-00	81-38229-00
											70-31306-10 642 533	652 636	614 827 90x104 A SL LD	81-24909-10
											16x		56 36 970 35x48 A SL RD MVQ	
2,0 Z 20 NET	129 kW (175 PS)	01/00-12/08	SIGNUM Turbo VECTRA C Turbo VECTRA II Turbo											
				02-36220-01 16 06 250 +56 07 811	08-38272-01 16 06 251	04-10166-01	61-36220-00 56 07 811 87,05 mm MLS	14-32169-01 607 208 (10x)	15-36236-01 56 07 942	12-34264-01 642 501 (16x)	71-36311-00	70-31414-10 	81-33489-10	81-33489-10
											71-36321-00		81-38229-00	81-38229-00
											70-34264-00 642 501	652 501	614 827 90x104 A SL LD	
											16x		20 91 167 42x55 RD FPM	

OPEL/VAUXHALL

Ltr. 													
2,0 20 D	40-43 kW (54-58 PS) ASCONA B D REKORD D D REKORD E D	08/74-10/82 		<p>02-23590-05 16 06 491 +642 521 (8x)  20 D 129252→</p>	<p>08-12841-07 16 06 720 +614 816  20 D 129252→</p> 		<p>61-23590-30 607 403 +638 182 87,7 Ø 1,4 mm</p> 		<p>71-23326-20 607 634</p> 	<p>12-27431-01 642 530 (8x)  20 D 129251</p>  <p>12-26044-01 642 521 (8x)  20 D 129252→</p>  <p>70-27431-00 642 530  20 D 129251</p>  <p>70-26044-00 642 521  20 D 129252→</p> 	<p>71-23428-10   </p> <p>850 605</p> 	<p>10-12841-02 16 06 230</p> 	<p>81-19195-00 </p> <p>638 187 45x60 A SL RD ACM</p>  <p>81-24077-00 </p> <p>614 816 81x100,1 AB SL LD FPM</p> 
2,0 20 N	66 kW (90 PS) ASCONA B MANTA B REKORD E	08/77-10/82		<p>02-26255-07 16 06 714 +642 530 (4x)</p> 	<p>08-12841-06 16 06 598 +614 815</p> 		<p>61-26255-10 607 971 +638 182 97 Ø 1 mm</p> 		<p>71-12944-00 607 664</p> 	<p>12-27431-02 642 452 (4x) +642 530 (4x)</p>  <p>40-77344-00 AS 642 452</p>  <p>70-27431-00 ES 642 530</p> 	<p>71-20654-10   </p> <p>850 619</p>  <p>71-23862-10   </p> <p>854 841</p> 	<p>10-12841-02 16 06 230</p> 	<p>81-19195-00 </p> <p>638 187 45x60 A SL RD ACM</p>  <p>81-20667-30 </p> <p>90 156 857 77x100 A SL LD FPM</p> 

OPEL/VAUXHALL														
Ltr.														
2,0 20 NEJ	82 kW (112 PS) VECTRA B	10/95-04/02	1											
					02-26775-05 16 06 916 +607 987 	08-31979-01 16 06 924 +646 265 		61-26775-10 607 987 87,5 Ø 1,3 mm 	14-32037-01 607 685 (10x) 	71-33367-00 638 733 	12-26546-01 642 527 (8x) 70-26546-00 642 527 	71-26510-10 850 601 71-25513-10 850 645 8x 71-25865-00 854 933 	71-31979-00 652 635 71-31978-00 652 636 	81-25516-10 646 265 31x50 A SL RD FPM 81-38229-00 614 827 90x104 A SL LD 81-24909-10 N 56 36 970 35x48 A SL RD MVQ
2,0 20 S	74-81 kW (100-110 PS) ASCONA B CARLTON II CAVALIER MANTA B REKORD D REKORD E	09/75-08/86			02-26255-08 16 06 710 +642 530 (4x) 	08-12841-06 16 06 598 +614 815 		61-26255-10 607 971 +638 182 97 Ø 1 mm 		71-12944-00 607 664 	12-27431-02 642 452 (4x) +642 530 (4x) 40-77344-00 AS 642 452 4x 70-27431-00 ES 642 530 4x	71-20654-10 850 619 71-23862-10 854 841 	10-12841-02 16 06 230 	81-19195-00 638 187 45x60 A SL RD ACM 81-20667-30 90 156 857 77x100 A SL LD FPM





















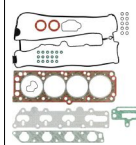

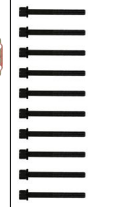

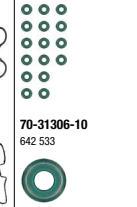











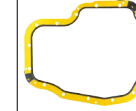







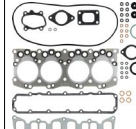



OPEL/VAUXHALL

Ltr. 	2,0 20 SE	85 kW (115-116 PS)	OMEGA OMEGA B	 03/94-12/00											
2,0 20 SE	85 kW (115-116 PS)	OMEGA OMEGA B	 03/94-12/00	<p>02-26775-03 16 06 823 +638 733 +642 527 (8x)</p> 	<p>08-31965-01 16 06 834 +646 265</p> 		<p>61-26775-10 607 987 87,5 Ø 1,3 mm</p> 	<p>14-32037-01 607 685 (10x)</p> 	<p>71-33367-00 638 733</p> 	<p>12-26546-01 642 527 (8x)</p> 	<p>71-26510-10 </p> <p>646 265 850 601</p> 	<p>71-25513-10 </p> <p>850 645</p> 	<p>71-31965-00 652 274</p> 	<p>81-25516-10 </p> <p>646 265 31x50 A SL RD FPM</p>  <p>81-38229-00 </p> <p>614 827 90x104 A SL LD</p>  <p>81-24909-10 </p> <p>56 36 970 35x48 A SL RD MVQ</p>  <p>81-27317-00 </p> <p>636 839 55x70,1 AB LD FPM</p> 	
2,0 20 SE	90 kW (122 PS)	CARLTON III OMEGA A	 09/86-03/94	<p>02-26775-02 16 06 664 +642 527 (8x)  02/94</p>  <p>02-26775-03 16 06 823 +638 733 +642 527 (8x)  03/94→</p> 	<p>08-27293-02 16 06 663  02/94</p>  <p>08-31965-01 16 06 834 +646 265  03/94→</p> 		<p>61-26775-10 607 987 87,5 Ø 1,3 mm</p> 	<p>14-32037-01 607 685 (10x)</p> 	<p>71-13045-30 638 192  02/94</p>  <p>71-33367-00 638 733  03/94→</p> 	<p>12-26546-01 642 527 (8x)</p> 	<p>71-26510-10 </p> <p>646 265 850 601</p> 	<p>71-25513-10 </p> <p>850 645</p> 	<p>71-27293-00 652 587  02/94</p>  <p>71-31965-00 652 274  03/94→</p> 	<p>81-25516-10 </p> <p>646 265 31x50 A SL RD FPM</p>  <p>81-38229-00 </p> <p>614 827 90x104 A SL LD</p>  <p>81-24909-10 </p> <p>56 36 970 35x48 A SL RD MVQ</p>  <p>81-27317-00 </p> <p>636 839 55x70,1 AB LD FPM</p> 	

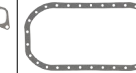
OPEL/VAUXHALL															
Ltr.															
2,0	4ZC1	60 kW (82 PS)	MIDI	06/88-08/97	01-52395-01 	02-52395-01 			61-52395-00 89,5 Ø 		15-52393-01 	12-52733-01 	71-52397-00 71-52398-00 	71-52396-00 	81-53268-00 56 36 816 40x56 A SL LD MVQ 81-53077-00 614 839 95x118 A SL LD FPM 81-53226-00 N 30x45 A SL OD MVQ
2,1	21 D	44 kW (60 PS)	REKORD D D REKORD E D	09/72-07/78		02-22910-03 16 06 490 +642 530 (8x) 	08-12841-07 16 06 720 +638 182 +614 816 	61-22910-30 607 404 +638 182 89,2 Ø 1,4 mm 		71-23326-20 607 634 	12-27431-01 642 530 (8x) 	71-23428-10 850 805 71-19846-10 854 835 	10-12841-02 16 06 230 	81-19195-00 638 167 45x60 A SL RD ACM 81-24077-00 614 816 81x100,1 AB SL LD FPM 	
2,2	A 22 DM A 22 DMH	120-135 kW (163-184 PS)	ANTARA ANTARA CDTI	12/10	02-40664-01 	08-41122-01 		61-37870-00 48 18 004 87 Ø 1,05 mm MLS 61-37870-10 48 18 005 87 Ø 1,15 mm MLS 61-37870-20 48 18 006 87 Ø 1,25 mm MLS 	14-32340-01 	15-40664-01 48 02 216 	12-38209-02 642 697 (16x) 	71-54213-00 71-40666-00 48 03 754 	70-31414-10 	81-40697-00 48 18 276 50x65 A SL RD PTFE 81-40698-00 48 18 010 98x114 A SL LD PTFE 	

OPEL/VAUXHALL

Ltr.  2.2 C 22 SEL 102 kW (139 PS) VECTRA B  07/00-07/02  1

										
<p>2.2 C 22 SEL 102 kW (139 PS) VECTRA B 07/00-07/02</p>	<p>02-33005-01 16 06 770 +607 647</p> 	<p>08-31965-02 16 06 787</p> 		<p>61-33005-10 56 07 628 87 Ø 1,3 mm</p> 	<p>14-32104-01 607 256 (10x)</p> 	<p>15-31997-01 607 647 +607 648 (10x)</p>  <p>71-31997-00 607 647</p> 	<p>12-31306-01 642 533 (16x)</p>  <p>70-31306-10 642 533</p> 	<p>71-31976-00  </p> <p>850 655</p>  <p>71-31971-00 </p> <p>850 656</p>  <p>16x 71-25865-00  </p> <p>854 933</p> 	<p>71-34163-00 652 607</p>  <p>71-31978-00 </p> <p>652 636</p> 	<p>81-25516-10 </p> <p>646 265 31x50 A SL RD FPM</p>  <p>81-38229-00 </p> <p>614 827 90x104 A SL LD</p>  <p>81-24909-10 </p> <p>56 36 970 35x48 A SL RD MVQ</p>  <p>2x</p>
<p>2.2 C 223 C223 39-54 kW (53-73 PS)</p>	<p>01-52405-01</p> 	<p>02-52405-01</p> 		<p>61-52405-00 89 Ø MLS</p> 		<p>71-52323-00</p> 	<p>12-52834-01 642 543 (8x)</p>  <p>70-52834-00 642 543</p> 	<p>71-52401-00  </p> 	<p>71-52403-00</p> 	<p>81-53298-00 </p> <p>65x84 A SL RD NBR</p>  <p>81-53327-00 </p> <p>82x105 A SL LD MVQ</p>  <p>81-53276-00 </p> <p>42x55 A SL RD FPM</p> 

PEL/VAUXHALL

PEL/VAUXHALL														
Ltr.														
2,2	G9T 720	66 kW (90 PS)	MOVANO DTI	09/00										
					<p>02-37682-01 44 33 416</p>	<p>08-33642-03 44 33 417</p>	<p>04-10124-01 </p>	<p>61-36520-00 88 0 1,24 mm MLS 010209→</p>	<p>14-32231-01 44 04 240 (10x)</p>	<p>15-37682-01 45 06 060</p>	<p>12-31306-01 642 533 (16x)</p>	<p>11-37824-01 </p> <p>45 06 108</p>	<p>71-33642-00 45 06 182</p>	<p>81-36842-00 </p> <p>44 03 530 60x75 A SL RD FPM/ACM</p> <p>81-36843-00 </p> <p>44 03 528 70x85 A SL RD FPM/ACM</p> <p>81-33646-00 </p> <p>45 06 016 93x108 A SL LD FPM</p> <p>81-17539-50 2x</p> <p>45 06 052 30x42 A SL RD FPM</p>
2,2	G9T 722 G9T 750	66 kW (90 PS)	MOVANO DTI	09/00										
					<p>02-37682-01 44 33 416</p>	<p>08-33642-03 44 33 417</p>		<p>61-36520-00 88 0 1,24 mm MLS 010209→</p>	<p>14-32231-01 44 04 240 (10x)</p>	<p>15-37682-01 45 06 060</p>	<p>12-31306-01 642 533 (16x)</p>	<p>11-37824-01 </p> <p>45 06 108</p>	<p>71-33642-00 45 06 182</p>	<p>81-36842-00 </p> <p>44 03 530 60x75 A SL RD FPM/ACM</p> <p>81-36843-00 </p> <p>44 03 528 70x85 A SL RD FPM/ACM</p> <p>81-33646-00 </p> <p>45 06 016 93x108 A SL LD FPM</p> <p>81-17539-50 2x</p> <p>45 06 052 30x42 A SL RD FPM</p>

OPEL/VAUXHALL

Ltr.	Motor	Power (kW/PS)	Model	Year Range	Image 1	Image 2	Image 3	Image 4	Image 5	Image 6	Image 7	Image 8	Image 9	Image 10	Image 11	Image 12
2.2	X 22 DTH	85 kW (116 PS)	SINTRA DTI	07/97-04/99												
					1	02-34277-01				61-33820-00 5607421 85,5 Ø 1,3 mm MLS	14-32105-01 607 923 (10x)	71-34277-00 56 07 442	12-31306-01 642 533 (16x)	71-34286-00 849 193	71-34164-00 652 605	81-35723-00 K 638 196 55x68 AB SL RD FPM
										61-33820-10 56 07 856 85,5 Ø 1,4 mm MLS				71-34933-00 58 50 638		81-34301-00 K 614 855 99x114 A LD FPM/ACM
										61-33820-20 56 07 630 85,5 Ø 1,5 mm MLS			70-31306-10 642 533	71-34279-00 849 213		
2.2	X 22 DTH Y 22 DTH	85-88 kW (116-120 PS)	FRONTERA B DTI FRONTERA II DTI	09/98-09/04						61-33820-00 5607421 85,5 Ø 1,3 mm MLS	14-32105-01 607 923 (10x)	71-34277-00 56 07 442	12-31306-01 642 533 (16x)	71-34286-00 849 193	71-35062-10 91 28 894	81-35723-00 K 638 196 55x68 AB SL RD FPM
										61-33820-10 56 07 856 85,5 Ø 1,4 mm MLS				71-34933-00 58 50 638	71-35063-10 652 576	81-34301-00 K 614 855 99x114 A LD FPM/ACM
										61-33820-20 56 07 630 85,5 Ø 1,5 mm MLS			70-31306-10 642 533	71-34279-00 849 213		
2.2	X 22 SE Y 22 SE	100 kW (136 PS)	FRONTERA B FRONTERA II	10/98-10/04						61-33005-10 56 07 628 87 Ø 1,3 mm	14-32104-01 607 256 (10x)	71-31997-00 607 647	12-31306-01 642 533 (16x)	71-31976-00 850 655	71-34163-00 652 607	81-25516-10 K 646 265 31x50 A SL RD FPM
														71-34278-00 849 934		81-38229-00 K 614 827 90x104 A SL LD
													70-31306-10 642 533			81-24909-10 N 56 36 970 35x48 A SL RD MVQ























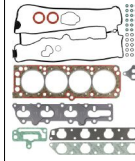

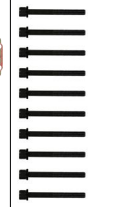















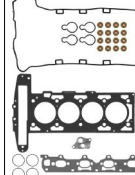

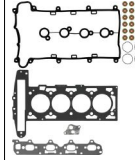

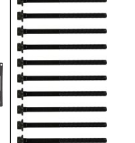



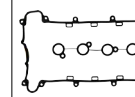



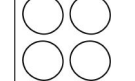







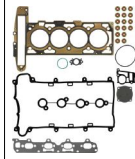
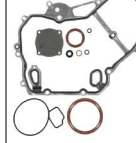
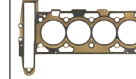

OPEL/VAUXHALL

Ltr.	Motor	Power (PS)	Model	Year	Image 1	Image 2	Image 3	Image 4	Image 5	Image 6	Image 7	Image 8	Image 9	Image 10	Image 11	Image 12
2.2	X 22 XE	100 kW (136 PS)	FRONTERA FRONTERA A	03/95-10/98												
						<p>02-33005-02 16 06 919 +642 533 (16x)</p>	<p>08-31965-02 16 06 787</p>		<p>61-33005-10 56 07 628 87 Ø 1,3 mm</p>	<p>14-32104-01 607 256 (10x)</p>	<p>15-31997-01 607 647 +607 648 (10x)</p> <p>71-31997-00 607 647</p>	<p>12-31306-01 642 533 (16x)</p> <p>70-31306-10 642 533</p>	<p>71-31976-00 </p> <p>850 655</p> <p>71-31971-00 </p> <p>850 656</p>	<p>71-13054-10 652 599</p> <p>71-34163-00 652 607</p>	<p>81-25516-10 </p> <p>646 265 31x50 A SL RD FPM</p> <p>81-38229-00 </p> <p>614 827 90x104 A SL LD</p> <p>81-24909-10 </p> <p>56 36 970 35x48 A SL RD MVQ</p>	
2.2	X 22 XE	104 kW (141 PS)	SINTRA	11/96-04/99												
						<p>02-33515-01 16 06 983 +642 533 (16x)</p>	<p>08-31979-02 16 06 994</p>		<p>61-33005-10 56 07 628 87 Ø 1,3 mm</p>	<p>14-32104-01 607 256 (10x)</p>	<p>15-31997-01 607 647 +607 648 (10x)</p> <p>71-31997-00 607 647</p>	<p>12-31306-01 642 533 (16x)</p> <p>70-31306-10 642 533</p>	<p>71-31976-00 </p> <p>850 655</p> <p>71-31971-00 </p> <p>850 656</p>	<p>71-31979-00 652 635</p>	<p>81-25516-10 </p> <p>646 265 31x50 A SL RD FPM</p> <p>81-38229-00 </p> <p>614 827 90x104 A SL LD</p> <p>81-24909-10 </p> <p>56 36 970 35x48 A SL RD MVQ</p>	
2.2	Y 22 DTH Y 22 DTR	81-92 kW (110-125 PS)	OMEGA B DTI OMEGA DTI VECTRA DTI	08/95-07/03												
						<p>02-34277-01</p> <p>61-33820-10 56 07 856 85,5 Ø 1,4 mm MLS</p> <p>61-33820-20 56 07 630 85,5 Ø 1,5 mm MLS</p>	<p>08-34164-01 16 06 399</p>	<p>04-10191-01 </p>	<p>14-32105-01 607 923 (10x)</p>	<p>71-34277-00 56 07 442</p>	<p>12-31306-01 642 533 (16x)</p> <p>70-31306-10 642 533</p>	<p>71-34286-00 </p> <p>849 193</p> <p>71-34933-00 </p> <p>58 50 638</p> <p>71-34279-00 </p> <p>849 213</p>	<p>71-34164-00 652 605</p>	<p>81-35723-00 </p> <p>638 196 55x68 AB SL RD FPM</p> <p>81-34301-00 </p> <p>614 855 99x114 A LD FPM/ACM</p>		

OPEL/VAUXHALL

Ltr.	Y 22 DTH	85-88 kW (116-120 PS)	FRONTERA II DTI	10/98-10/04												
2.2	Y 22 DTH	85-88 kW (116-120 PS)	FRONTERA II DTI	10/98-10/04		02-34277-01 	08-35062-01 16 06 057 	04-10191-01 	61-33820-00 5607421 85,5 Ø 1,3 mm MLS 1	14-32105-01 607 923 (10x) 	71-34277-00 56 07 442 	12-31306-01 642 533 (16x) 	71-34286-00 849 193 	71-35062-10 91 28 894 	81-35723-00 638 196 55x68 AB SL RD FPM 	
									61-33820-10 56 07 856 85,5 Ø 1,4 mm MLS 2			70-31306-10 642 533 	71-34933-00 58 50 638 	71-35063-10 652 576 	81-34301-00 614 855 99x114 A LD FPM/ACM 	
									61-33820-20 56 07 630 85,5 Ø 1,5 mm MLS 3							
2.2	Y 22 DTR	86-92 kW (117-125 PS)	ASTRA G DTI SIGNUM DTI VECTRA C DTI VECTRA II DTI	04/02-10/08	<td> <td> <td> <td> <td> <td> <td> <td> <td> </td></td></td></td></td></td></td></td></td>	<td> <td> <td> <td> <td> <td> <td> <td> </td></td></td></td></td></td></td></td>	<td> <td> <td> <td> <td> <td> <td> </td></td></td></td></td></td></td>	<td> <td> <td> <td> <td> <td> </td></td></td></td></td></td>	<td> <td> <td> <td> <td> </td></td></td></td></td>	<td> <td> <td> <td> </td></td></td></td>	<td> <td> <td> </td></td></td>	<td> <td> </td></td>	<td> </td>			
2.2	Y 22 DTR	86-92 kW (117-125 PS)	ASTRA G DTI SIGNUM DTI VECTRA C DTI VECTRA II DTI	04/02-10/08		02-34277-01 	08-34164-01 16 06 399 	04-10191-01 	61-33820-00 5607421 85,5 Ø 1,3 mm MLS 1	14-32105-01 607 923 (10x) 	71-34277-00 56 07 442 	12-31306-01 642 533 (16x) 	71-34286-00 849 193 	71-34164-00 652 605 	81-35723-00 638 196 55x68 AB SL RD FPM 	
									61-33820-10 56 07 856 85,5 Ø 1,4 mm MLS 2				70-31306-10 642 533 	71-35319-00 849 521 		81-34301-00 614 855 99x114 A LD FPM/ACM
									61-33820-20 56 07 630 85,5 Ø 1,5 mm MLS 3							
2.2	Y 22 DTR	86-92 kW (117-125 PS)	VECTRA B DTI ZAFIRA DTI	09/00-06/05	<td> <td> <td> <td> <td> <td> <td> <td> <td> </td></td></td></td></td></td></td></td></td>	<td> <td> <td> <td> <td> <td> <td> <td> </td></td></td></td></td></td></td></td>	<td> <td> <td> <td> <td> <td> <td> </td></td></td></td></td></td></td>	<td> <td> <td> <td> <td> <td> </td></td></td></td></td></td>	<td> <td> <td> <td> <td> </td></td></td></td></td>	<td> <td> <td> <td> </td></td></td></td>	<td> <td> <td> </td></td></td>	<td> <td> </td></td>	<td> </td>			
2.2	Y 22 DTR	86-92 kW (117-125 PS)	VECTRA B DTI ZAFIRA DTI	09/00-06/05		02-34277-01 	08-34164-01 16 06 399 	04-10191-01 	61-33820-00 5607421 85,5 Ø 1,3 mm MLS 1	14-32105-01 607 923 (10x) 	71-34277-00 56 07 442 	12-31306-01 642 533 (16x) 	71-34286-00 849 193 	71-34164-00 652 605 	81-35723-00 638 196 55x68 AB SL RD FPM 	
									61-33820-10 56 07 856 85,5 Ø 1,4 mm MLS 2				70-31306-10 642 533 	71-34933-00 58 50 638 03/02 		81-34301-00 614 855 99x114 A LD FPM/ACM
									61-33820-20 56 07 630 85,5 Ø 1,5 mm MLS 3							

OPEL/VAUXHALL

<p>Ltr. </p>	<p>2.2 Y 22 XE Z 22 XE</p>	<p>106 kW (144 PS) OMEGA OMEGA B</p>	<p> 01/94-07/03</p>											
<p>2.2 Z 22 SE</p>	<p>108 kW (147 PS)</p>	<p>ASTRA G ASTRA IV SPEEDSTER VECTRA VECTRA B VECTRA C VECTRA II VX220 ZAFIRA</p>	<p>08/95-12/08</p>	<p>02-33005-05 16 06 076</p> 	<p>08-31979-03 16 06 077</p> 		<p>61-33005-10 56 07 628 87 Ø 1,3 mm</p> 	<p>14-32104-01 607 256 (10x)</p> 	<p>15-31997-01 607 647 +607 648 (10x)</p>  <p>71-31997-00 607 647</p> 	<p>12-31306-01 642 533 (16x)</p>  <p>70-31306-10 642 533</p> 	<p>71-34273-00  850 669</p>  <p>71-34278-00  849 934</p> 	<p>71-31979-00 652 635</p> 	<p>81-25516-10  646 265 31x50 A SL RD FPM</p>  <p>81-38229-00  614 827 90x104 A SL LD</p>  <p>81-24909-10  2x 56 36 970 35x48 A SL RD MVQ</p> 	
<p>2.2 Z 22 SE</p>	<p>108 kW (147 PS)</p>	<p>ASTRA G ASTRA IV SPEEDSTER VECTRA VECTRA B VECTRA C VECTRA II VX220 ZAFIRA</p>	<p>08/95-12/08</p>	<p>02-34330-01  16 06 078</p>  <p>02-34330-02  16 06 266</p> 	<p>08-38272-01 16 06 251</p> 		<p>61-34330-00 56 07 474 87 Ø 0,5 mm MLS</p> 	<p>14-32169-01 607 208 (10x)</p> 	<p>15-34276-01  56 07 180</p>  <p>71-36218-00  56 07 512</p> 	<p>12-34264-01 642 501 (16x)</p>  <p>70-34264-00 642 501</p> 	<p>11-34269-01  850 516</p>  <p>71-34287-00  58 50 649</p> 	<p>70-31414-10</p> 	<p>81-34489-10  20 91 167 42x55 RD FPM</p>  <p>81-38229-00  614 827 90x104 A SL LD</p> 	
<p>2.2 Z 22 YH</p>	<p>110-114 kW (150-155 PS)</p>	<p>SIGNUM VECTRA C VECTRA II ZAFIRA ZAFIRA II</p>	<p>01/02-11/14</p>	<p>02-36215-01 16 06 239 +56 07 814</p> 	<p>08-38272-01 16 06 251</p> 		<p>61-36215-00 56 07 814 MLS</p> 	<p>14-32169-01 607 208 (10x)</p> 	<p>71-36218-00 56 07 512</p> 	<p>12-34264-01 642 501 (16x)</p>  <p>70-34264-00 642 501</p> 	<p>71-34287-00  58 50 649</p> 	<p>70-31414-10</p> 	<p>81-34489-10  20 91 167 42x55 RD FPM</p>  <p>81-38229-00  614 827 90x104 A SL LD</p> 	

OPEL/VAUXHALL														
2.2	22 E	85 kW (115 PS)	CARLTON II MONZA A REKORD E SENATOR SENATOR A	11/84-08/87										
Ltr.					02-26255-05 16 06 717 +642 530 (8x)	08-12841-06 16 06 598 +614 815	61-26255-10 607 971 +638 182 97 Ø 1 mm	14-32039-01 20 24 152 (5x) +20 24 153 (5x)	71-12944-00 607 664	12-27431-01 642 530 (8x)	71-26364-10 850 660	10-12841-02 16 06 230	81-19195-00 K↔ 638 187 45x60 A SL RD ACM 81-20667-30 K↔ 90 156 857 77x100 A SL LD FPM	
2.2	23 TD 23 YDT	63-66 kW (86-90 PS)	CARLTON III TD SENATOR	11/84-08/88										
					02-23326-04 607 400 +638 182 93,2 Ø 1,4 mm	08-12841-07 16 06 720 +614 816	61-24430-00 607 400 +638 182 93,2 Ø 1,4 mm	14-32042-02 607 238 (10x)	71-23326-20 607 634	12-27236-01 642 528 (8x)	71-27237-10 850 609	10-12841-02 16 06 230	81-19195-00 K↔ 638 187 45x60 A SL RD ACM 81-24077-00 K↔ 614 816 81x100,1 AB SL LD FPM	
					61-24430-10 607 420 +638 182 93,2 Ø 1,5 mm		61-24430-20 607 402 +638 182 93,2 Ø 1,6 mm			70-27236-00 642 528				
2.2	4HB (DW12RUD) 4HH (DW12RUC) 4HK (DW12RUE)	88-121 kW (120-165 PS)	MOVANO MOVANO D	12/21										
					02-12453-01 35 53 124 86 Ø 1,25 mm MLS	08-12456-01	04-10350-01 35 52 936 (10x)	61-10212-00 35 53 124 86 Ø 1,25 mm MLS	14-12457-01 35 52 936 (10x)	71-12453-00 36 48 405	12-38539-01 35 52 968 (16x)	71-12455-00 35 53 035	70-31414-10 36 48 409	81-36557-00 K↔ 39 166 040 42x62 A SL RD PTFE 81-36556-00 K↔ 35 53 064 90x110 A SL LD PTFE 81-34144-00 N 35 52 931 27x47 A SL RD FPM
							61-10212-10 36 48 401 86 Ø 1,3 mm MLS	61-10212-20 36 48 402 86 Ø 1,35 mm MLS	61-10212-30 36 48 403 86 Ø 1,4 mm MLS		70-38539-00 16x			

OPEL/VAUXHALL														
2,3	M9T 670 M9T 672 M9T 676 M9T 678 M9T 680 M9T 686 M9T 690 M9T 692 M9T 694 M9T 696 M9T 698 M9T 878 M9T 880 M9T 890 M9T 892	74-110 kW (101-150 PS)	MOVANO B CDTI MOVANO CDTI MOVANO II CDTI	05/10										
Ltr.					02-42140-01 93 168 363 +95 516 098 	08-38518-01 93 168 364 	04-10288-01 	61-42140-10 95 516 098 85,8 Ø 1,15 mm MLS 	14-32231-01 44 04 240 (10x) 	15-42163-01 93 168 260 	12-33512-02 44 23 068(8X) 	71-35023-00 44 31 182 71-37064-00 44 20 469 	70-31414-10 	81-38518-00 93 161 608 50x81 RD PTFE ACM 81-10477-00 44 18 253 Gummi
2,3	M9T 670 M9T 696 M9T 870 M9T 876 M9T 896 M9T 898	74-110 kW (101-150 PS)	MOVANO B CDTI MOVANO CDTI MOVANO II CDTI	05/10	02-42140-01 93 168 363 +95 516 098 	08-38518-01 93 168 364 		61-42140-10 95 516 098 85,8 Ø 1,15 mm MLS 	14-32231-01 44 04 240 (10x) 	15-42163-01 93 168 260 	12-33512-02 44 23 068(8X) 	71-35023-00 44 31 182 71-37064-00 44 20 469 	70-31414-10 	81-38518-00 93 161 608 50x81 RD PTFE ACM 81-10477-00 44 18 253 Gummi
2,3	M9T 700 M9T 702	100-120 kW (136-163 PS)	MOVANO B CDTI MOVANO CDTI	05/14	02-10046-01 44 23 750 		04-10372-01 95 518 953 	61-10134-00 44 23 599 86 Ø 2,1 mm MLS ⇒ 07/15 61-10268-00 95 524 192 86 Ø 1,15 mm MLS 08/15 → 	14-32231-01 44 04 240 (10x) 	15-10053-01 44 23 661 	12-33512-02 44 23 068(8X) 	71-13274-00 95524170 71-13040-00 44 23 625 	70-31414-10 	81-38518-00 93 161 608 50x81 RD PTFE ACM 81-10477-00 44 18 253 Gummi

OPEL/VAUXHALL

OPEL/VAUXHALL														
2,3	M9T 702	100-120 kW (136-163 PS)	MOVANO B CDTI	05/14		<p>02-10046-01 44 23 750</p>	<p>04-10372-01 </p> <p>95 518 953</p>	<p>61-10134-00 44 23 599 86 Ø 2,1 mm MLS ⇒ 07/15</p> <p>61-10268-00 95 524 192 86 Ø 1,15 mm MLS 08/15→</p>	<p>14-32231-01 44 04 240 (10x)</p>	<p>15-10053-01 44 23 661</p>	<p>12-33512-02 44 23 068(8X)</p>	<p>71-13040-00 </p> <p>44 23 625</p>	<p>70-31414-10</p>	<p>81-38518-00 </p> <p>93 161 608 50x81 RD PTFE ACM</p> <p>81-10477-00 </p> <p>44 18 253 Gummi</p>
2,3	M9T 702	120 kW (163 PS)	MOVANO CDTI	05/14		<p>02-10046-01 44 23 750</p>	<p>04-10372-01 </p> <p>95 518 953</p>	<p>61-10134-00 44 23 599 86 Ø 2,1 mm MLS ⇒ 07/15</p> <p>61-10268-00 95 524 192 86 Ø 1,15 mm MLS 08/15→</p>	<p>14-32231-01 44 04 240 (10x)</p>	<p>15-10053-01 44 23 661</p>	<p>12-33512-02 44 23 068(8X)</p>	<p>71-13274-00 </p> <p>95524170</p> <p>71-13040-00 </p> <p>44 23 625</p>	<p>70-31414-10</p>	<p>81-38518-00 </p> <p>93 161 608 50x81 RD PTFE ACM</p> <p>81-10477-00 </p> <p>44 18 253 Gummi</p>
2,3	M9T 704 M9T 708	96-120 kW (131-163 PS)	MOVANO B CDTI MOVANO CDTI	05/10		<p>02-10046-01 44 23 750</p>	<p>61-10268-00 95 524 192 86 Ø 1,15 mm MLS</p>	<p>14-32231-01 44 04 240 (10x)</p>	<p>15-10053-01 44 23 661</p>	<p>12-33512-02 44 23 068(8X)</p> <p>70-33512-00 642 542</p>	<p>71-10144-00 </p> <p>95520940</p> <p>71-13040-00 </p> <p>44 23 625</p> <p>16x</p>	<p>70-31414-10</p>	<p>81-38518-00 </p> <p>93 161 608 50x81 RD PTFE ACM</p> <p>81-10477-00 </p> <p>44 18 253 Gummi</p>	

OPEL/VAUXHALL														
2,3	M9T 706 M9T 716	100-132 kW (136-179 PS)	MOVANO B CDTI MOVANO CDTI MOVANO II CDTI	05/10										
Ltr.														
2,3	M9T 710	96-120 kW (131-163 PS)	MOVANO B CDTI MOVANO CDTI	05/10										
2,3	23 D	48-52 kW (65-71 PS)	CARLTON CARLTON II D REKORD E D	08/78-08/86										

02-10046-01
44 23 750

04-10372-01

95 518 953

61-10268-00
95 524 192
86 Ø
1,15 mm
MLS

14-32231-01
44 04 240 (10x)

15-10053-01
44 23 661

12-33512-02
44 23 068(8x)

70-33512-00
642 542

71-10144-00

95520940

70-31414-10

81-38518-00

93 161 608
50x81
RD PTFE ACM

81-10477-00

44 18 253
Gummi

02-24430-03
16 06 462
+642 530 (8x)
 105317

08-12841-07
16 06 720
+614 816

61-24430-00
607 400
+638 182
93,2 Ø
1,4 mm

61-24430-10
607 420
+638 182
93,2 Ø
1,5 mm

61-24430-20
607 402
+638 182
93,2 Ø
1,6 mm

14-32042-02
607 238 (10x)

71-23326-20
607 634

12-27431-01
642 530 (8x)
 105317

12-26044-01
642 521 (8x)
 105318→

70-27431-00
642 530
 105317

70-26044-00
642 521
 105318→

71-23428-10

850 605

10-12841-02
16 06 230

81-19195-00

638 187
45x60
A SL RD ACM

81-24077-00

614 816
81x100,1
AB SL LD FPM























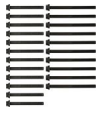
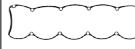

















OPEL/VAUXHALL														
2.3	23 DTR 23 TD 23 YDT	63-74 kW (86-100 PS)	CARLTON III TD FRONTERA A TD FRONTERA TD OMEGA A TD REKORD E TD SENATOR A TD	06/84-10/98										
Ltr.					02-23326-04 16 06 720 +614 816	08-12841-07 16 06 720 +614 816		61-24430-00 607 400 +638 182 93,2 Ø 1,4 mm	14-32042-02 607 238 (10x)	71-23326-20 607 634	12-27236-01 642 528 (8x)	71-27237-10	10-12841-02 16 06 230	81-19195-00 K 638 187 45x60 A SL RD ACM
								61-24430-10 607 420 +638 182 93,2 Ø 1,5 mm			70-27236-00 642 528	8x		81-24077-00 K 614 816 81x100,1 AB SL LD FPM
								61-24430-20 607 402 +638 182 93,2 Ø 1,6 mm						
2.3	23 YD	54 kW (73 PS)	CARLTON III D OMEGA A D	09/86-03/94				61-24430-00 607 400 +638 182 93,2 Ø 1,4 mm	14-32042-02 607 238 (10x)	71-23326-20 607 634	12-26044-01 642 521 (8x)	71-23428-10	10-12841-02 16 06 230	81-19195-00 K 638 187 45x60 A SL RD ACM
								61-24430-10 607 420 +638 182 93,2 Ø 1,5 mm			70-26044-00 642 521	8x		81-24077-00 K 614 816 81x100,1 AB SL LD FPM
								61-24430-20 607 402 +638 182 93,2 Ø 1,6 mm						
2.4	A 24 XE	123 kW (167 PS)	ANTARA	12/10				61-37900-00 48 02 776 90 Ø MLS	14-10018-01 11 589 328	15-40822-01 48 05 044	12-34264-01 642 501 (16x)	11-77639-01	70-31414-10 	81-33489-10 K 20 91 167 42x55 RD FPM
											70-34264-00 642 501	16x	71-54222-00	81-38229-00 K 614 827 90x104 A SL LD
												71-39351-00		

OPEL/VAUXHALL																
2,4	A 24 XF	123 kW (167 PS)	ANTARA	12/10		02-37900-01 	08-39572-01 	61-37900-00 48 02 776 90 Ø MLS 	14-32169-01 607 208 (10x) 	15-40822-01 48 05 044 	12-34264-01 642 501 (16x) 	11-77639-01 24 455 112 (4x) 	70-31414-10 	81-33489-10 20 91 167 42x55 RD FPM 		
											70-34264-00 642 501 	16x 71-54222-00 12 575 851 	71-39351-00 48 13 565 		81-38229-00 614 827 90x104 A SL LD 	
2,4	C 24 NE	92 kW (125 PS)	FRONTERA FRONTERA A OMEGA A	09/88-10/98		02-28185-01 16 06 713 +642 530 (8x) 	08-28123-01 16 06 712 +614 815 	61-26255-10 607 971 +638 182 97 Ø 1 mm 	14-32039-01 20 24 152 (5x) +20 24 153 (5x) 	71-28229-00 607 972 	12-27431-01 642 530 (8x) 	71-28228-10 850 611 	71-28123-00 652 601 	81-19195-10 638 187 45x60 A SL RD ACM 		
												8x 70-27431-00 642 530 	71-27409-00 854 948 		81-20667-30 90 156 857 77x100 A SL LD FPM 	
2,4	Z 24 SED Z 24 XE Z 24 XED	100-104 kW (136-141 PS)	ANTARA ANTARA LPG	07/06		01-31965-01 	02-31965-01 48 03 328 	08-31965-02 16 06 787 	61-10132-00 48 07 965 48 03 328 MLS 	14-32104-01 607 256 (10x) 	15-31997-01 607 647 +607 648 (10x) 	12-31306-12 642 533 (16x) 	71-38242-00 48 05 207 	70-31414-10 	81-25516-10 646 265 31x50 A SL RD FPM 	
												71-31997-00 607 647 	70-31306-00 642 533 	71-38159-00 48 05 206 		81-38229-00 614 827 90x104 A SL LD
																81-24909-10 56 36 970 35x48 A SL RD MVQ

OPEL/VAUXHALL													
2,5	C 25 XE	125 kW (170 PS)	CALIBRA CALIBRA A CAVALIER III V6 VECTRA A	08/88-07/97									
Ltr.					02-34230-01 608 632	08-34159-01 16 06 836	61-34230-00 608 632 83 Ø	14-32104-02 607 256 (16x)	15-34268-02 607 642	12-31306-11 642 533 (12x)	71-34237-00 58 50 607	71-34159-00 652 665	81-28236-00 646 269 38x50 A SL RD FPM
											71-34239-00 850 670		81-38229-00 614 827 90x104 A SL LD
										70-31306-10 642 533			
													81-24909-10 N 56 36 970 35x48 A SL RD MVQ
2,5	G9U 630 G9U 632 G9U 650 G9U 724 G9U 730 G9U 750	74-107 kW (101-146 PS)	MOVANO CDTI MOVANO DTI VIVARI CDTI VIVARO CDTI VIVARO D VIVARO DTI	10/01									
					02-37682-01 44 33 416	08-33642-03 44 33 417	61-36540-00 44 17 145 90 Ø 1,2 mm MLS	14-32231-01 44 04 240 (10x)	15-37682-01 45 06 060	12-31306-01 642 533 (16x)	11-37824-01 45 06 108	71-33642-00 45 06 182	81-36842-00 44 03 530 60x75 A SL RD FPM/ACM
							61-36540-10 90 Ø 1,5 mm MLS			70-31306-00 642 533	71-37871-00 44 31 934		81-36843-00 44 03 528 70x85 A SL RD FPM/ACM
													81-33646-00 45 06 016 93x108 A SL LD FPM
													81-17539-50 N 45 06 052 30x42 A SL RD FPM

OPEL/VAUXHALL														
Ltr.														
2,5	G9U 720 G9U 724 G9U 750 G9U 754	73-84 kW (99-115 PS)	MOVANO CDTI MOVANO DTI	01/01										
					02-37682-01 44 33 416 	08-33642-03 44 33 417 	04-10013-01 	61-36540-00 44 17 145 90 Ø 1,2 mm MLS 61-36540-10 90 Ø 1,5 mm MLS 	14-32231-01 44 04 240 (10x) 	15-37682-01 45 06 060 	12-31306-01 642 533 (16x) 70-31306-00 642 533 	11-37824-01 45 06 108 71-37871-00 44 31 934 	71-33642-00 45 06 182 	81-36842-00 44 03 530 60x75 A SL RD FPM/ACM 81-36843-00 44 03 528 70x85 A SL RD FPM/ACM 81-33646-00 45 06 016 93x108 A SL LD FPM 81-17539-50 2x 45 06 052 30x42 A SL RD FPM
2,5	H 25 E 25 NE	100-103 kW (136-140 PS)	MONZA A SENATOR A SENATOR B	05/81-09/93				61-28120-00 607 994 +638 182 90,8 Ø 1,1 mm 	14-32039-02 20 24 152 (7x) +20 24 153 (7x) 	71-27334-00 607 628 	12-27431-04 642 530 (12x) 70-27431-00 642 530 	10-12842-02 16 06 184 	81-19195-00 638 187 45x60 A SL RD ACM 81-20667-30 90 156 857 77x100 A SL LD FPM 	

OPEL/VAUXHALL

Ltr.	S8U 758	55 kW (75 PS)	ARENA D	03/98-08/01	1											
																
2,5	S8U 758	55 kW (75 PS)	ARENA D	03/98-08/01	1		02-31733-01 	08-31749-03 		61-33610-00 44 03 135 95,2 Ø 1,65 mm 61-33610-10 44 03 136 95,2 Ø 1,7 mm 61-33610-20 44 03 137 95,2 Ø 1,8 mm 	14-32096-01 44 00 178 (10x) +44 00 179 (12x) 	71-31733-00 44 04 657 	12-34914-05 44 03 139 (8x) 	71-33621-00  4x 44 03 007  71-33654-00  4x 45 00 797 	71-34049-10 44 05 674 	81-33623-00  K 44 03 049 70x90 A SL RD FPM  81-33858-00  K 100x118 AB SL LD MVQ  81-33627-00 N 44 01 858 55x70 A SL RD FPM 
2,5	S8U 770	59 kW (80 PS)	MOVANO D	07/98-08/02			02-33951-07 45 02 790 		61-33610-00 44 03 135 95,2 Ø 1,65 mm 61-33610-10 44 03 136 95,2 Ø 1,7 mm 61-33610-20 44 03 137 95,2 Ø 1,8 mm 	14-32096-01 44 00 178 (10x) +44 00 179 (12x) 	71-33951-10 44 03 515 	12-34914-05 44 03 139 (8x) 	71-33621-00  4x 44 03 007  71-33654-00  4x 45 00 797 	71-34049-10 44 05 674 	81-10173-00  K FPM  81-33623-00  K 44 03 049 70x90 A SL RD FPM  81-90042-00  K 9 109 925 FPM  81-33627-00 N 44 01 858 55x70 A SL RD FPM 	

OPEL/VAUXHALL

OPEL/VAUXHALL														
Ltr.														
2,5	S8U 772	59 kW (80 PS)	MOVANO D	07/98-08/02										
				1		<p>02-33951-07 45 02 790</p>								
						<p>61-33610-00 44 03 135 95,2 Ø 1,65 mm</p> <p>61-33610-10 44 03 136 95,2 Ø 1,7 mm</p> <p>61-33610-20 44 03 137 95,2 Ø 1,8 mm</p>								
							<p>14-32096-01 44 00 178 (10x) +44 00 179 (12x)</p>							
								<p>71-33951-10 44 03 515</p>						
									<p>12-34914-05 44 03 139 (8x)</p>					
										<p>71-33621-00 4x 44 03 007</p>				
											<p>71-33654-00 4x 45 00 797</p>			
												<p>71-34049-10 44 05 674</p>		
												<p>81-33623-00 </p> <p>44 03 049 70x90 A.SL.RD.FPM → 2728901</p>		
												<p>81-10173-00 </p> <p>FPM 2728902→</p>		
												<p>81-90042-00 </p> <p>9 109 925 FPM</p>		
												<p>81-33627-00 N</p> <p>44 01 858 55x70 A.SL.RD.FPM</p>		
2,5	S8U 780 S8U 782 25 DG 25 DM	55 kW (75 PS)	ARENA D	01/97-12/01										
						<p>61-33610-00 44 03 135 95,2 Ø 1,65 mm</p> <p>61-33610-10 44 03 136 95,2 Ø 1,7 mm</p> <p>61-33610-20 44 03 137 95,2 Ø 1,8 mm</p>								
							<p>14-32096-01 44 00 178 (10x) +44 00 179 (12x)</p>							
								<p>71-33951-10 44 03 515</p>						
									<p>12-34914-05 44 03 139 (8x)</p>					
										<p>71-33621-00 4x 44 03 007</p>				
											<p>71-33654-00 4x 45 00 797</p>			
												<p>71-34049-10 44 05 674</p>		
												<p>81-33623-00 </p> <p>44 03 049 70x90 A.SL.RD.FPM → 2728901</p>		
												<p>81-33627-00 N</p> <p>44 01 858 55x70 A.SL.RD.FPM</p>		

OPEL/VAUXHALL

OPEL/VAUXHALL													
Ltr.			1										
2,5 U 25 DT U 25 TD X 25 DT X 25 TD	96 kW (130-131 PS) OMEGA B TD OMEGA TD	04/94-07/03		08-31298-02 16 06 767 	04-10014-01	61-31335-10 56 07 407 80 Ø 1,87 mm 	14-32004-01 607 967 (14x) 	71-31344-00 56 07 428 	12-31306-08 642 533 (12x) 	71-29398-10 850 666 71-29396-00 850 665 71-29399-00 58 50 614	6x 71-31298-00 652 600	81-17404-50 638 269 48x65 AB SL RD FPM 81-20745-00 614 802 90x110 AB SL LD PTFE (Polytetrafluorethylen)/ACM (Polyacryl-Kautschuk)	
2,5 X 25 TD	96 kW (131 PS) OMEGA TD	04/94-07/01		08-31298-02 16 06 767 		61-31335-10 56 07 407 80 Ø 1,87 mm 	14-32004-01 607 967 (14x) 	71-31344-00 56 07 428 	12-31306-08 642 533 (12x) 	71-29398-10 850 666 71-29396-00 850 665 71-29399-00 58 50 614	6x 71-31298-00 652 600	81-17404-50 638 269 48x65 AB SL RD FPM 81-20745-00 614 802 90x110 AB SL LD PTFE (Polytetrafluorethylen)/ACM (Polyacryl-Kautschuk)	
2,5 X 25 XE	125 kW (170 PS) CALIBRA 8077708	04/93-07/97		08-34159-01 16 06 836 		61-34230-00 2x 608 632 83 Ø 	14-32104-02 607 256 (16x) 		12-31306-11 2x 642 533 (12x) 		71-34159-00 652 665 	81-28236-00 646 269 38x50 A SL RD FPM 81-38229-00 614 827 90x104 A SL LD 81-24909-10 56 36 970 35x48 A SL RD MVQ 4x	

OPEL/VAUXHALL

Ltr. 2,5 X 25 XE
 125 kW (170 PS) CALIBRA A 8077708
 04/93-07/97 1

	02-34230-01 608 632 83 Ø	08-34159-01 16 06 836		61-34230-00 608 632 83 Ø	14-32104-02 607 256 (16x)	15-34268-02 607 642	12-31306-11 642 533 (12x)	71-34237-00 58 50 607	71-34159-00 652 665	81-28236-00 646 269 38x50 A SL RD FPM	81-38229-00 614 827 90x104 A SL LD	81-24909-10 N 56 36 970 35x48 A SL RD MVQ

2,5 X 25 XE
 125 kW (170 PS) OMEGA B 8300418
 03/94-09/00

	02-34230-02 608 632 83 Ø	08-33422-01 16 06 020		61-34230-00 608 632 83 Ø	14-32104-02 607 256 (16x)	15-34268-02 607 642	12-31306-11 642 533 (12x)	71-34241-00 849 510	71-33421-00 652 612	81-28236-00 646 269 38x50 A SL RD FPM	81-38229-00 614 827 90x104 A SL LD	81-24909-10 N 56 36 970 35x48 A SL RD MVQ

OPEL/VAUXHALL



Ltr.  2,5 X 25 XE
 125 kW (170 PS) OMEGA V6  8300418  03/94-09/00

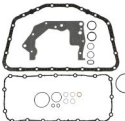

08-33422-01
16 06 020

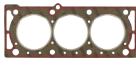

61-34230-00 2x
608 632
83 Ø

14-32104-02
607 256 (16x)



12-31306-11 2x
642 533 (12x)



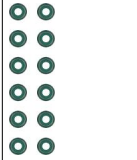

70-31306-10 24x
642 533



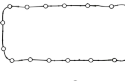

71-33421-00
652 612



71-33422-00 
652 634



81-28236-00 
646 269
38x50
A SL RD FPM



81-38229-00 
614 827
90x104
A SL LD





81-24909-10 **N** 4x
56 36 970
35x48
A SL RD MVQ

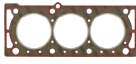

2,5 X 25 XE
 125 kW (170 PS) OMEGA V6  8300418 Omega 03/94-09/00

61-34230-00 2x
608 632
83 Ø

14-32104-02
607 256 (16x)





12-31306-11 2x
642 533 (12x)

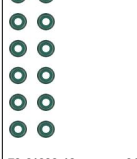

70-31306-10 24x
642 533



71-33422-00 
652 634



81-28236-00 
646 269
38x50
A SL RD FPM



81-38229-00 
614 827
90x104
A SL LD



81-24909-10 **N** 4x
56 36 970
35x48
A SL RD MVQ



OPEL/VAUXHALL

Ltr. 2,5 X 25 XE
 125 kW (170 PS) CALIBRA 8077709→
 04/93-07/97

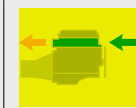

2,5 X 25 XE
 125 kW (170 PS) CALIBRA A 8077709→
 04/93-07/97

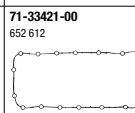
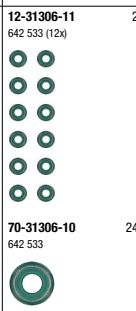
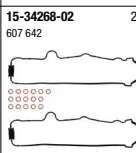
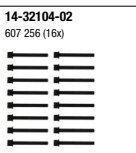
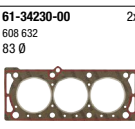
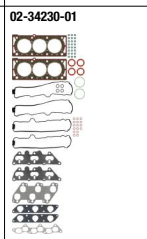

08-33421-01
 16 06 893

61-34230-00 2x
 608 632
 83 Ø

14-32104-02
 607 256 (16x)

12-31306-11 2x
 642 533 (12x)

70-31306-10 24x
 642 533

71-33421-00
 652 612

81-28236-00 K →
 646 269
 38x50
 A SL RD FPM

81-38229-00 K →
 614 827
 90x104
 A SL LD

81-24909-10 N 4x
 56 36 970
 35x48
 A SL RD MVQ

08-33421-01
 16 06 893

61-34230-00 2x
 608 632
 83 Ø

14-32104-02
 607 256 (16x)

15-34268-02 2x
 607 642

12-31306-11 2x
 642 533 (12x)

70-31306-10 24x
 642 533

71-34237-00 → 2x
 58 50 607

71-34247-00 → ②
 850 663

71-34239-00 → 2x
 850 670

71-33421-00
 652 612

81-28236-00 K →
 646 269
 38x50
 A SL RD FPM

81-38229-00 K →
 614 827
 90x104
 A SL LD

81-24909-10 N 4x
 56 36 970
 35x48
 A SL RD MVQ

OPEL/VAUXHALL





































Ltr. 2,5 X 25 XE 125 kW (170 PS) OMEGA B 8300419→ 03/94-09/00 1

		02-34230-02 608 632 83 Ø	08-34896-01 16 06 074		61-34230-00 608 632 83 Ø	14-32104-02 607 256 (16x)	15-34268-02 607 642	12-31306-11 642 533 (12x)	71-34241-00 2x 642 533 (12x)	71-34242-00 3x 849 509	71-34239-00 2x 850 670	70-31414-10 642 533	81-28236-00 K→ 646 269 38x50 A SL RD FPM	81-38229-00 K→ 614 827 90x104 A SL LD	81-24909-10 N 4x 56 36 970 35x48 A SL RD MVQ	

























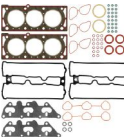

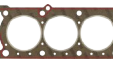















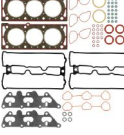

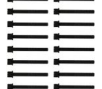















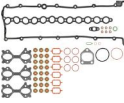

2,5 X 25 XE 125 kW (170 PS) OMEGA V6 8300419→ 03/94-09/00

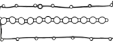
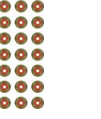
			08-34896-01 16 06 074		61-34230-00 608 632 83 Ø	14-32104-02 607 256 (16x)		12-31306-11 642 533 (12x)				70-31414-10 642 533	81-28236-00 K→ 646 269 38x50 A SL RD FPM	81-38229-00 K→ 614 827 90x104 A SL LD	81-24909-10 N 4x 56 36 970 35x48 A SL RD MVQ	

















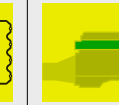
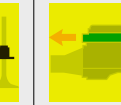
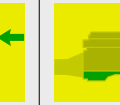











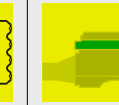
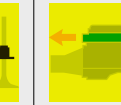
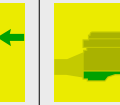























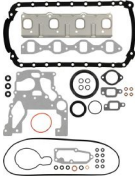











OPEL/VAUXHALL

Ltr. 													
2,5 X 25 XE	125-144 kW VECTRA B (170-196 PS)	09/95-09/00		02-34230-03 	08-33421-01 16 06 893 		61-34230-00 2x 608 632 83 Ø 	14-32104-02 607 256 (16x) 	71-34261-00 2x 607 653 	12-31306-11 2x 642 533 (12x) 	71-34241-00 2x 849 510 	71-33421-00 652 612 	81-28236-00 K↔ 646 269 38x50 A SL RD FPM 
2,5 X 25 XE	125-144 kW VECTRA B (170-196 PS)	09/95-09/00		02-34230-03 	08-34896-01 16 06 074 		61-34230-00 2x 608 632 83 Ø 	14-32104-02 607 256 (16x) 	71-34261-00 2x 607 653 	12-31306-11 2x 642 533 (12x) 	71-34241-00 2x 849 510 	70-31414-10 	81-28236-00 K↔ 646 269 38x50 A SL RD FPM 













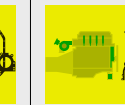
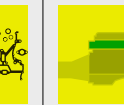
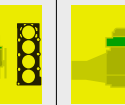

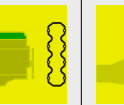
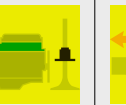
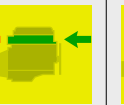

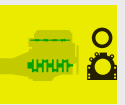



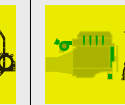



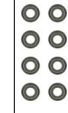









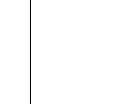
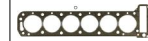
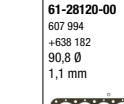







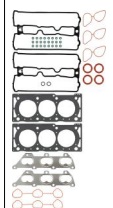

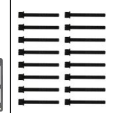
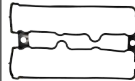



OPEL/VAUXHALL

<p>Ltr. </p>														
<p>2,5 X 25 XE</p>	<p>143 kW (194 PS)</p>	<p>VECTRA</p>	<p> 8446108</p>	<p>03/98-07/00</p>	<p>02-34230-03 608 632 83 Ø</p> 	<p>08-33421-01 16 06 893</p> 	<p>61-34230-00 2x 608 632 83 Ø</p> 	<p>14-32104-02 607 256 (16x)</p> 	<p>12-31306-11 2x 642 533 (12x)</p> 	<p>71-34241-00  2x 849 510</p> <p>71-34242-00   3x 849 509</p> <p>71-34239-00  2x 850 670</p> 	<p>71-33421-00 652 612</p> 	<p>81-28236-00  K </p> <p>646 269 38x50 A SL RD FPM</p> 	<p>81-38229-00  K </p> <p>614 827 90x104 A SL LD</p> 	<p>81-24909-10 N 4x</p> <p>56 36 970 35x48 A SL RD MVQ</p> 
<p>2,5 X 25 XE</p>	<p>143 kW (194 PS)</p>	<p>VECTRA</p>	<p> 8446109 →</p>	<p>03/98-07/00</p>	<p>02-34230-03</p> 	<p>08-34896-01 16 06 074</p> 	<p>61-34230-00 2x 608 632 83 Ø</p> 	<p>14-32104-02 607 256 (16x)</p> 	<p>12-31306-11 2x 642 533 (12x)</p> 	<p>71-34241-00  2x 849 510</p> <p>71-34242-00   3x 849 509</p> <p>71-34239-00  2x 850 670</p> 	<p>70-31414-10</p> 	<p>81-28236-00  K </p> <p>646 269 38x50 A SL RD FPM</p> 	<p>81-38229-00  K </p> <p>614 827 90x104 A SL LD</p> 	<p>81-24909-10 N 4x</p> <p>56 36 970 35x48 A SL RD MVQ</p> 
<p>2,5 Y 25 DT</p>	<p>110 kW (150 PS)</p>	<p>OMEGA B DTI</p>	<p>09/01-07/03</p>		<p>02-35176-01</p> 	<p>04-10029-01 </p> 	<p>61-35005-00 56 07 470 80 Ø 1,45 mm MLS</p> <p>61-35005-10 56 07 471 80 Ø 1,55 mm MLS</p> <p>61-35005-20 56 07 472 80 Ø 1,65 mm MLS</p> 	<p>14-32004-01 607 967 (14x)</p> 	<p>71-37402-00 56 07 473</p> 	<p>12-35172-02 642 544 (24x)</p> 	<p>71-33109-10  6x 58 50 788</p> <p>71-33027-00  3x 849 198</p> 	<p>70-35172-00 24x 642 544</p> 	<p>81-20745-00  K </p> <p>614 802 90x110 AB SL LD PTFE (Polytetrafluorethylen)/ACM (Polyacryl-Kautschuk)</p> 	

OPEL/VAUXHALL																
2,5	25 DT	96 kW (130-131 PS)	OMEGA B TD	04/94-07/03		02-31296-02 16 06 765 	08-31298-02 16 06 767 	04-10014-01 	61-31335-10 56 07 407 80 Ø 1,87 mm	14-32004-01 607 967 (14x) 	71-31296-00 56 07 405 	12-31306-08 642 533 (12x) 	71-29398-10 850 666 6x 71-29396-00 850 665 4x 71-29399-00 58 50 614 	71-31298-00 652 600 	81-17404-50 638 269 48x65 AB SL RD FPM 	81-20745-40 614 838 90x110 A SL LD FPM
2,5	25 E	96-110 kW (130-150 PS)	COMMODORE A COMMODORE C MONZA A SENATOR SENATOR A SENATOR II	08/69-10/90	02-28120-02 16 06 547 +642 530 (12x) 35130	08-12842-03 16 06 665 +614 815 35130		61-28120-00 607 994 +638 182 90,8 Ø 1,1 mm	14-32039-02 20 24 152 (7x) +20 24 153 (7x) 35131 →	71-12907-10 607 666 45754 71-27334-00 607 628 45755 →	12-27431-04 642 530 (12x) 	71-24663-20 850 658 35130	10-12842-02 16 06 184 	81-19195-00 638 187 45x60 A SL RD ACM 	81-20667-30 90 156 857 77x100 A SL LD FPM 	
2,5	25 H	96 kW (130-131 PS)	COMMODORE A COMMODORE B	08/67-08/75				61-28120-00 607 994 +638 182 90,8 Ø 1,1 mm 		71-12907-10 607 666 	40-77344-00 12x 642 452 	71-20661-20 850 698 35130 71-23910-00 854 837	10-12842-02 16 06 184 	81-19195-00 638 187 45x60 A SL RD ACM 	81-20667-30 90 156 857 77x100 A SL LD FPM 	
2,5	25 S	85 kW (115-116 PS)	COMMODORE A COMMODORE B COMMODORE C SENATOR SENATOR A VICEROY	08/67-12/82	02-28120-01 16 06 284 +642 530 (6x) 113625 →	08-12842-03 16 06 665 +614 815 		61-28120-00 607 994 +638 182 90,8 Ø 1,1 mm 		71-12945-00 607 667 	12-27431-03 642 452 (6x) +642 530 (6x) 	71-20661-20 850 698 35130 71-23910-00 854 837	10-12842-02 16 06 184 	81-19195-00 638 187 45x60 A SL RD ACM 	81-20667-30 90 156 857 77x100 A SL LD FPM 	
					02-28120-03 16 06 577 +642 530 (6x) 248869 →						40-77344-00 AS 6x 642 452 	70-27431-00 ES 6x 642 530 				

OPEL/VAUXHALL															
Ltr. 															
2,5 25 TDS 25TD	85 kW (115 PS) FRONTERA A TDS	09/96-10/98													
							61-35410-00 98,5 Ø 1,42 mm		71-10224-00 	12-34914-05 44 03 139 (8x)    	71-35481-00  4x 			81-10392-00  52x68 PTFE	81-35099-00  110x130 A SL LD FPM
							61-35410-10 60605899 98,5 Ø 1,52 mm								
							61-35410-20 60605898 98,5 Ø 1,62 mm 								
2,5 25TDS (VM41B)	85 kW (115 PS) FRONTERA TDS	11/91-10/98				04-10148-01 	61-35410-00 98,5 Ø 1,42 mm		71-10224-00 	12-34914-05 44 03 139 (8x)    	71-35481-00  4x 			81-10392-00  52x68 PTFE	81-35099-00  110x130 A SL LD FPM
							61-35410-10 60605899 98,5 Ø 1,52 mm								
							61-35410-20 60605898 98,5 Ø 1,62 mm 								
2,5 4 JA1 4JA1	56-74 kW (76-101 PS) CAMPO D	08/91	01-52675-01 	02-52675-01 			61-52675-00 56 07 415 94 Ø 1,6 mm MLS 		15-52414-02 56 07 441 	12-52834-01 642 543 (8x)      70-52834-00 642 543 	71-52962-00  8x 850 518  71-52963-00  8x  71-52964-00  8x 850 625 	71-52413-00 	81-53426-00  56 36 816 50x68 A SL RD FPM	81-53077-00  614 839 95x118 A SL LD FPM	
							61-52675-10 56 07 416 94 Ø 1,65 mm MLS 								
							61-52675-20 56 07 417 94 Ø 1,7 mm MLS 								
															
														81-53268-00  56 36 816 40x66 A SL LD MVQ	

OPEL/VAUXHALL

Ltr.	4JA1-TC	74 kW (101 PS)	CAMPO DTI	07/01-12/01														
2,5	4JA1-TC	74 kW (101 PS)	CAMPO DTI	07/01-12/01					<p>61-52675-00 56 07 415 94 Ø 1,6 mm MLS</p> <p>61-52675-10 56 07 416 94 Ø 1,65 mm MLS</p> <p>61-52675-20 56 07 417 94 Ø 1,7 mm MLS</p> 	<p>14-32145-01 607 327 (18x)</p> 		<p>12-52834-01 642 543 (8x)</p> 	<p>71-53973-00 </p> 		<p>81-53426-00 </p> <p>56 36 816 50x68 A SL RD FPM</p> 	<p>81-53077-00 </p> <p>614 839 95x118 A SL LD FPM</p> 		
2,6	C 26 NE	110 kW (150 PS)	CARLTON III OMEGA A SENATOR B SENATOR II	09/90-03/94					<p>61-28120-00 607 994 +638 182 90,8 Ø 1,1 mm</p> 		<p>71-27334-00 607 628</p> 	<p>12-27431-04 642 530 (12x)</p> 	<p>10-12842-02 16 06 184</p> 	<p>81-19195-00 </p> <p>636 187 45x60 A SL RD ACM</p> 	<p>81-20667-30 </p> <p>90 156 857 77x100 A SL LD FPM</p> 			
2,6	Y 26 SE	125 kW (170 PS)	VECTRA B VECTRA V6	09/00-07/03		<p>02-34225-01</p> 	<p>08-34896-01 16 06 074</p> 	<p>61-34225-00 2x 56 07 465 84 Ø 0,6 mm MLS</p> 	<p>14-32104-02 607 256 (16x)</p> 	<p>71-34261-00 2x 607 653</p> 	<p>12-31306-11 2x 642 533 (12x)</p> 	<p>71-34241-00  2x 849 510</p> 	<p>71-34242-00   3x 849 509</p> 	<p>71-34271-00 2x 849 848</p> 	<p>70-31414-10</p> 	<p>81-28236-00 </p> <p>646 269 38x50 A SL RD FPM</p> 	<p>81-38229-00 </p> <p>614 827 90x104 A SL LD</p> 	<p>81-24909-10  4x</p> <p>56 36 970 35x48 A SL RD MVQ</p> 





















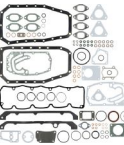

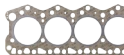











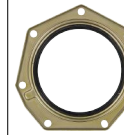



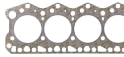



OPEL/VAUXHALL

OPEL/VAUXHALL															
Ltr.															
2,6	Y 26 SE	132 kW (180 PS)	OMEGA B		21999999	09/00-07/03	08-34896-01 16 06 074		61-34225-00 2x 56 07 465 84 Ø 0,6 mm MLS	14-32104-02 607 256 (16x)	15-34268-02 2x 607 642	12-31306-11 2x 642 533 (12x)	71-34241-00 2x 849 510	70-31414-10	81-28236-00 K → 646 269 38x50 A SL RD FPM
															81-38229-00 K → 614 827 90x104 A SL LD
															81-24909-10 N 4x 56 36 970 35x48 A SL RD MVQ
2,6	Y 26 SE	132 kW (180 PS)	OMEGA V6		21999999	08/00-07/03	08-34896-01 16 06 074		61-34225-00 2x 56 07 465 84 Ø 0,6 mm MLS	14-32104-02 607 256 (16x)	15-34268-02 2x 607 642	12-31306-11 2x 642 533 (12x)	71-34241-00 2x 849 510	70-31414-10	81-28236-00 K → 646 269 38x50 A SL RD FPM
															81-38229-00 K → 614 827 90x104 A SL LD
															81-24909-10 N 4x 56 36 970 35x48 A SL RD MVQ

OPEL/VAUXHALL

Ltr.		132 kW (180 PS)		OMEGA B	31000001→	09/00-07/03																
2,6	Y 26 SE	132 kW (180 PS)	OMEGA B	31000001→	09/00-07/03				08-34896-01 16 06 074 			61-34225-00 2x 56 07 465 84 Ø 0,6 mm MLS 	14-32104-02 607 256 (16x) 	15-38269-01 2x 56 07 833 	12-31306-11 2x 642 533 (12x) 	71-34241-00 2x 849 510 	70-31414-10 	81-28236-00 K↔ 646 269 38x50 A SL RD FPM 				
															81-38229-00 K↔ 614 827 90x104 A SL LD 				81-24909-10 N 4x 56 36 970 35x48 A SL RD MVQ 			
2,6	Y 26 SE	132 kW (180 PS)	OMEGA V6	31000001→	08/00-07/03				08-34896-01 16 06 074 			61-34225-00 2x 56 07 465 84 Ø 0,6 mm MLS 	14-32104-02 607 256 (16x) 	15-38269-01 2x 56 07 833 	12-31306-11 2x 642 533 (12x) 	71-34241-00 2x 849 510 	70-31414-10 	81-28236-00 K↔ 646 269 38x50 A SL RD FPM 				
																				81-38229-00 K↔ 614 827 90x104 A SL LD 		81-24909-10 N 4x 56 36 970 35x48 A SL RD MVQ
2,8	A 28 NER A 28 NET B 28 NER	191-239 kW (260-325 PS)	INSIGNIA Turbo INSIGNIA V6		07/08-05/17							61-37220-00 R 48 07 957 MLS 	14-32293-01 2x 56 07 748 (8x) 	71-40707-00 L 12641261 	12-38226-01 2x 642 688 (12x) 	71-38239-00 2x 58 49 911 	70-31414-10 	81-38237-00 K↔ 646 973 50x70 AB SL RD PTFE 				
												61-37225-00 L 48 07 956 MLS 		71-40708-00 R 48 19 405 	70-38226-00 24x 642 688 				81-90046-00 K↔ 173x228 A SL LD LD PTFE 			

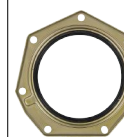
OPEL/VAUXHALL

Ltr.	S9W 700	84 kW (114 PS)	MOVANO DTI	MOVANO TDI	07/98-10/01	1				
										
<p>01-33951-10</p> 	<p>02-33951-10</p> 			<p>61-33950-00 45 00 883 1,3 mm</p> <p>61-33950-10 45 00 884 1,4 mm</p> <p>61-33950-20 45 00 885 1,5 mm</p> 	<p>14-32096-01 44 00 178 (10x) +44 00 179 (12x)</p> 	<p>71-33951-10 44 03 515</p> 	<p>12-34914-05 44 03 139 (8x)</p>  <p>70-34914-00 44 03 139</p> 	<p>71-33621-00  4x 44 03 007</p> <p>71-33654-00  4x 45 00 797</p> 	<p>71-33944-10 45 00 839</p> 	<p>81-35914-00 K  44 03 190 50x70 RD Silikon</p>  <p>81-90042-00 K  9 109 925 FPM</p>  <p>81-33627-00 N 44 01 858 55x70 A SL RD FPM</p> 
			<p>04-10047-01 </p> 	<p>61-33950-00 45 00 883 1,3 mm</p> <p>61-33950-10 45 00 884 1,4 mm</p> <p>61-33950-20 45 00 885 1,5 mm</p> 	<p>14-32096-01 44 00 178 (10x) +44 00 179 (12x)</p> 	<p>71-33951-10 44 03 515</p> 	<p>12-34914-05 44 03 139 (8x)</p>  <p>70-34914-00 44 03 139</p> 	<p>71-33621-00  4x 44 03 007</p> <p>71-33654-00  4x 45 00 797</p> 	<p>71-33944-10 45 00 839</p> 	<p>81-35914-00 K  44 03 190 50x70 RD Silikon</p>  <p>81-90042-00 K  9 109 925 FPM</p>  <p>81-33627-00 N 44 01 858 55x70 A SL RD FPM</p> 

OPEL/VAUXHALL														
Ltr.														
2,8	Z 28 NEL Z 28 NET	169-206 kW (230-280 PS)	SIGNUM Turbo SIGNUM V6 Turbo VECTRA C Turbo VECTRA II Turbo	07/05-05/09										
					02-37220-01 R 16 06 538 02-37225-01 L 16 06 540 			61-37220-00 R 48 07 957 MLS 61-37225-00 L 48 07 956 MLS 	14-32293-01 56 07 748 (6x) 	71-38171-00 R 642 970 71-38172-00 L 642 969 	12-38226-01 642 688 (12x) 70-38226-00 642 688 	71-38222-00 I → 58 50 845 → 61999999 71-38223-00 I → 58 50 188 → 71000001 → 71-38174-00 I → 2x 58 50 840 71-38239-00 → 2x 58 49 911 	70-31414-10 	81-38237-00 K → 646 973 50x70 AB SL RD PTFE 81-90046-00 K → 173x228 A SL LD LD PTFE
2,8	28 E 28 EC	118-121 kW (160-165 PS)	ADMIRAL B COMMODORE B DIPLOMAT B	03/69-08/78						71-12907-10 607 666 	12-27431-03 642 452 (6x) +642 530 (6x) 40-77344-00 AS 6x 642 452 70-27431-00 ES 6x 642 530 	71-23910-00 → 854 837 	10-12842-02 16 06 184 	81-19195-00 K → 638 187 45x60 A SL RD ACM 81-20667-30 K → 90 156 857 77x100 A SL LD FPM
2,8	28 H	103-107 kW (140-146 PS)	ADMIRAL B KAPITÁN B MONZA A ROYALE SENATOR SENATOR A	08/68-08/87	02-28120-01 16 06 284 +642 530 (6x) → 102080 	08-12842-03 16 06 665 +614 815 → 102080 		71-12945-00 607 667 	12-27431-03 642 452 (6x) +642 530 (6x) → 102080 12-27431-04 642 530 (12x) → 102081 → 	71-20661-20 → 850 698 71-23910-00 → 854 837 	10-12842-02 16 06 184 	81-19195-00 K → 638 187 45x60 A SL RD ACM 81-20667-30 K → 90 156 857 77x100 A SL LD FPM 		

OPEL/VAUXHALL															
Ltr.															
2,8 28 HC 28 HL	103-114 kW (140-155 PS)	ADMIRAL A COMMODORE A COMMODORE B DIPLOMAT B	10/67-08/78												
2,8 28 S	92-97 kW (125-132 PS)	ADMIRAL A ADMIRAL B KAPITÄN A KAPITÄN B	03/64-01/78		02-28120-01 16 06 284 +642 530 (6x)	08-12842-03 16 06 665 +614 815				71-12907-10 607 666	71-12945-00 607 667	12-27431-03 642 452 (6x) +642 530 (6x)	71-20661-20 850 698	10-12842-02 16 06 184	81-19195-00 638 187 45x60 A SL RD ACM
											40-77344-00 AS 642 452 6x	70-27431-00 ES 642 530 6x	71-20661-20 850 698	10-12842-02 16 06 184	81-20667-30 90 156 857 77x100 A SL LD FPM
2,8 28 TDI 28 TDI (4JB1-T) 28TD	83 kW (113 PS)	FRONTERA A TD FRONTERA TD	01/95-08/98	01-52414-01	02-52414-01		04-10003-01	61-52675-00 56 07 415 94 Ø 1,6 mm MLS	14-32145-01 607 327 (18x)	15-52414-02 56 07 441	12-52834-01 642 543 (8x)	71-52962-00 850 518	10-52968-01 652 603 +652 606 +652 637	81-53351-00 95x118 AB SL LD MVQ	
								61-52675-10 56 07 416 94 Ø 1,65 mm MLS			70-52834-00 642 543 8x	71-52963-00 850 625	71-52964-00 850 625	81-53268-00 N 56 36 816 40x56 A SL LD MVQ	
								61-52675-20 56 07 417 94 Ø 1,7 mm MLS							

OPEL/VAUXHALL

Ltr. 2,9 30 E 132 kW (180 PS) ROYALE 02/78-12/86 **1**

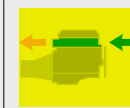
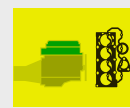

2,9 30 E 132 kW (180 PS) ROYALE 02/78-12/86

02-24675-09
16 06 466
+642 530 (6x)
➔ 30 E 31333

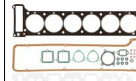

02-24675-10
16 06 466
+642 530 (12x)
➔ 30 E 31334➔
➔ 30 E 85748

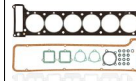

02-24675-11
16 06 609
+642 530 (12x)
➔ 30 E 85749➔

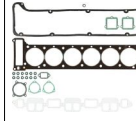

08-12842-03
16 06 665
+614 815



61-24675-20
607 982
+638 182
97 Ø
1,1 mm



14-32039-02
20 24 152 (7x)
+20 24 153 (7x)
➔ 30 E 31334➔

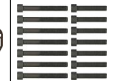

71-12907-10
607 666
➔ 30 E 85748



71-27334-00
607 628
➔ 30 E 85749➔



12-27431-03
642 452 (6x)
+642 530 (6x)
➔ 30 E 31333



12-27431-04
642 530 (12x)
➔ 30 E 31334➔



40-77344-00 AS 6x
642 452
➔ 30 E 31333



70-27431-00 ES 6x
642 530
➔ 30 E 31333



70-27431-00 12x
642 530
➔ 30 E 31334➔



71-24663-20
850 658



10-12842-02
16 06 184



81-19195-00 K
638 187
45x60
A SL RD ACM



81-20667-30 K
90 156 857
77x100
A SL LD FPM



3,0 A 30 XF 183-190 kW ANTARA (249-258 PS) 11/10

61-37220-00 R
48 07 957
MLS

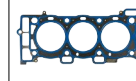

61-37225-00 L
48 07 956
MLS

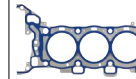

14-32293-01 2x
56 07 748 (6x)

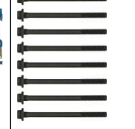

71-40676-00 L
48 02 231



71-40708-00 R
48 19 405



12-38226-01 2x
642 688 (12x)

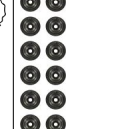

70-38226-00 24x
642 688



71-40688-00 2x
20 893 953



70-31414-10

OPEL/VAUXHALL													
3,0 A 30 XH	183-190 kW (249-258 PS)	ANTARA	11/10										
Ltr.													
61-37220-00 R 48 07 957 MLS	61-37225-00 L 48 07 956 MLS	14-32293-01 56 07 748 (8x)	71-40676-00 L 48 02 231	12-38226-01 642 688 (12x)	71-40688-00 20 893 953	70-31414-10	81-40709-00 K↔ 40x70 A SL RD FPM	81-10397-00 K↔ 12 620 955 99x115 LD FPM					
3,0 C 30 LE	115 kW (156 PS)	MONZA A OMEGA A SENATOR SENATOR A SENATOR B	09/85-03/94										
61-24675-20 607 982 +638 182 97 Ø 1,1 mm	14-32039-02 20 24 152 (7x) +20 24 153 (7x)	71-27334-00 607 628	12-27431-04 642 530 (12x)	70-27431-00 642 530	10-12842-02 16 06 184	81-19195-00 K↔ 638 187 45x60 A SL RD ACM	81-20667-30 K↔ 90 156 857 77x100 A SL LD FPM						
3,0 C 30 NE 30 NE	130-135 kW (177-183 PS)	CARLTON III OMEGA A SENATOR B SENATOR II	03/87-03/94										
61-24675-20 607 982 +638 182 97 Ø 1,1 mm	14-32039-02 20 24 152 (7x) +20 24 153 (7x)	71-27334-00 607 628	12-27431-04 642 530 (12x)	70-27431-00 642 530	71-28231-10 850 614	10-12842-02 16 06 184	81-19195-00 K↔ 638 187 45x60 A SL RD ACM	81-20667-30 K↔ 90 156 857 77x100 A SL LD FPM					
3,0 C 30 SE C 30 SEJ	147-150 kW (200-204 PS)	CARLTON III OMEGA A SENATOR B SENATOR II	09/88-04/94										
61-27560-00 607 973 1,3 mm	71-34291-00 607 632	12-26546-03 642 527 (24x)	71-34272-00 850 644	71-34283-00 850 637	71-34289-00 652 598	81-24077-00 K↔ 614 816 81x100,1 AB SL LD FPM							

OPEL/VAUXHALL

Ltr.  3,0 X 30 XE 148 kW (201 PS) SINTRA  11/96-04/99



3,0 X 30 XE 148 kW (201 PS) SINTRA 11/96-04/99

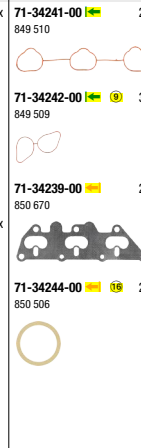
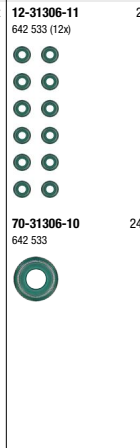
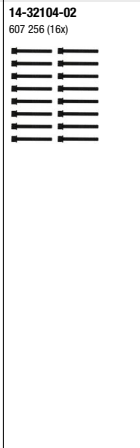
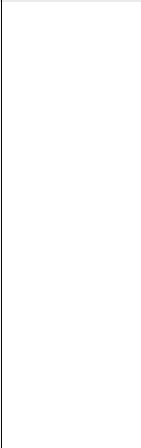
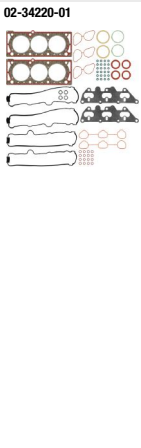

02-34220-01
16 06 893
8300418

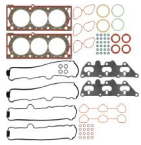

08-33421-01
16 06 893
8300418



08-34896-01
16 06 074
8300419→



08-33421-01
16 06 893
8300418



08-34896-01
16 06 074
8300419→



61-34220-00 2x
608 633
87 Ø



14-32104-02
607 256 (16x)



15-34268-02 2x
607 642



12-31306-11 2x
642 533 (12x)



70-31306-10 24x
642 533



71-34241-00 2x
849 510



71-34242-00 3x
849 509



71-34239-00 2x
850 670



71-34244-00 2x
850 506



71-33421-00
652 612
8300418



70-31414-10
8300419→



71-34244-00 2x
850 506



81-28236-00 K→
646 269
38x50
A SL RD FPM



81-38229-00 K→
614 827
90x104
A SL LD



81-24909-10 N 4x
56 36 970
35x48
A SL RD MVQ



3,0 X 30 XE 155 kW (211 PS) OMEGA B OMEGA V6 04/94-02/01

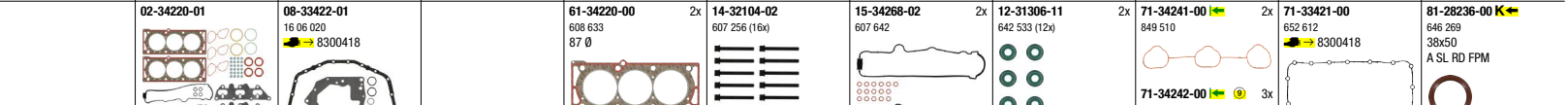

3,0 X 30 XE 155 kW (211 PS) OMEGA B OMEGA V6 04/94-02/01

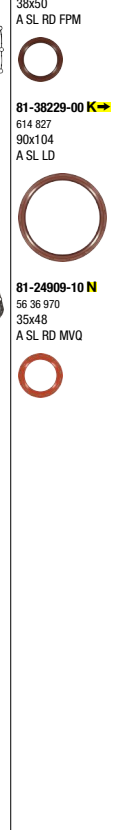
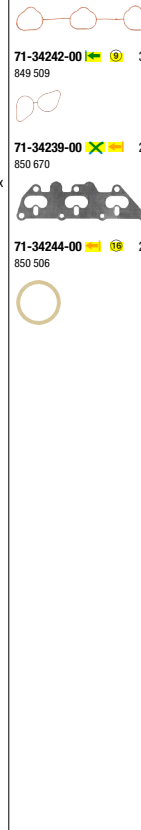
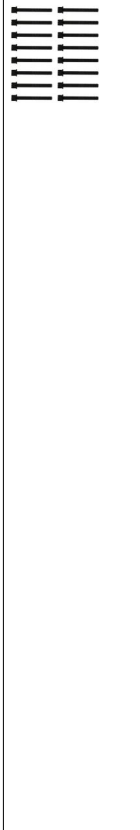
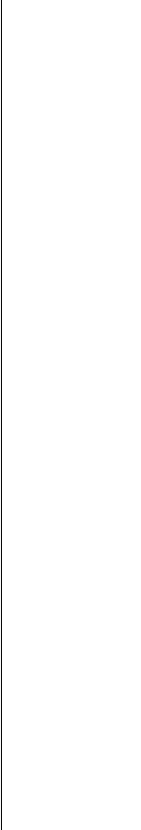

02-34220-01
16 06 820
8300418



08-33422-01
16 06 820
8300418



08-34896-01
16 06 074
8300419→



08-33422-01
16 06 820
8300418



08-34896-01
16 06 074
8300419→



61-34220-00 2x
608 633
87 Ø



14-32104-02
607 256 (16x)



15-34268-02 2x
607 642



12-31306-11 2x
642 533 (12x)



70-31306-10 24x
642 533



71-34241-00 2x
849 510



71-34242-00 3x
849 509



71-34239-00 2x
850 670



71-34244-00 2x
850 506



71-33421-00
652 612
8300418



70-31414-10
8300419→



71-34244-00 2x
850 506



81-28236-00 K→
646 269
38x50
A SL RD FPM



81-38229-00 K→
614 827
90x104
A SL LD

















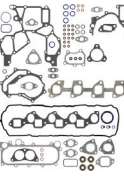

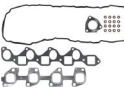













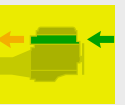











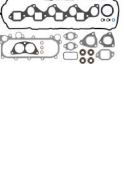
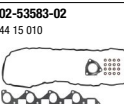



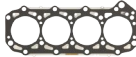

81-24909-10 N 4x
56 36 970
35x48
A SL RD MVQ



PEL/VAUXHALL

Ltr.											
<p>3,0 Y 30 DT</p> <p>130 kW (177 PS)</p> <p>SIGNUM CDTI VECTRA C CDTI VECTRA II V6 CDTI VECTRA II V6 CDTI</p> <p>02/03-05/08</p> <p>1</p>	<p></p>	<p>02-36216-01 2x</p> <p></p>			<p>61-36185-00 R 56 07 819 1 MLS</p> <p>61-36185-10 R 56 07 820 2 MLS</p> <p>61-36185-20 R 56 07 821 3 MLS</p> <p></p> <p>61-36190-00 L 56 07 822 1 MLS</p> <p>61-36190-10 L 56 07 823 2 MLS</p> <p>61-36190-20 L 56 07 824 3 MLS</p> <p></p>	<p>14-32288-01 56 07 948 (8x) +56 07 949 (8x)</p> <p></p>	<p>71-36216-00 2x 56 07 825</p> <p></p>	<p>12-36206-01 2x 642 535 (12x)</p> <p></p> <p>70-36206-00 24x 642 535</p> <p></p>	<p>71-36309-00 L 2x 58 50 688</p> <p></p> <p>71-36314-00 2x 849 524</p> <p></p>		<p>81-36231-00 K 614 903 50x68 A SL RD FPM</p> <p></p> <p>81-53077-00 K 614 839 95x118 A SL LD FPM</p> <p></p> <p>81-36971-00 N 56 36 410 37x50 A SL LD ACM</p> <p></p>
<p>3,0 Z 30 DT</p> <p>135 kW (184 PS)</p> <p>SIGNUM CDTI SIGNUM V6 CDTI VECTRA C CDTI VECTRA II CDTI</p> <p>07/05-12/08</p>					<p>61-36185-00 R 56 07 819 1 MLS</p> <p>61-36185-10 R 56 07 820 2 MLS</p> <p>61-36185-20 R 56 07 821 3 MLS</p> <p></p> <p>61-36190-00 L 56 07 822 1 MLS</p> <p>61-36190-10 L 56 07 823 2 MLS</p> <p>61-36190-20 L 56 07 824 3 MLS</p> <p></p>	<p>14-32291-01 56 07 982 (8x) +56 07 983 (8x)</p> <p></p>	<p>71-36216-00 2x 56 07 825</p> <p></p>	<p>12-38224-01 2x 642 971 (12x)</p> <p></p> <p>70-38224-00 24x 642 971</p> <p></p>	<p>71-38147-00 L 2x 58 50 479</p> <p></p> <p>71-38161-00 2x 849 942</p> <p></p>		<p>81-36231-00 K 614 903 50x68 A SL RD FPM</p> <p></p> <p>81-53077-00 K 614 839 95x118 A SL LD FPM</p> <p></p>

OPEL/VAUXHALL

















































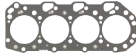



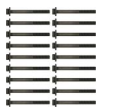

<p>Ltr.   </p> <p>3,0 ZD3 200 ZD3 202</p> <p>100 kW (136 PS) MOVANO DTI</p> <p>10/03</p>	 <p>01-53583-03 44 15 009</p> 	 <p>02-53583-02 44 15 010</p> 		 <p>04-10192-01 </p> 	 <p>61-53530-00 44 15 051 97 Ø 0,65 mm MLS 1 </p> <p>61-53530-10 44 15 052 97 Ø 0,7 mm MLS 2 </p> 		 <p>71-53583-00 44 15 227</p> 	 <p>12-52748-01 44 16 537 (16x)</p>  <p>70-53957-00 16x</p> 	 <p>71-53586-00 </p> <p>44 15 282</p>  <p>71-38512-00 </p> <p>44 19 191</p> 		 <p>81-53584-00 </p> <p>44 15 083 52x66 FPM</p>  <p>81-90044-00 </p> <p>44 15 044</p> 
<p>3,0 ZD3 202</p> <p>100 kW (136 PS) MOVANO DTI</p> <p>10/03</p>	 <p>01-53583-03 44 15 009</p> 	 <p>02-53583-02 44 15 010</p> 			<p>61-53530-00 44 15 051 97 Ø 0,65 mm MLS 1 </p> <p>61-53530-10 44 15 052 97 Ø 0,7 mm MLS 2 </p> 		<p>71-53583-00 44 15 227</p> 	<p>12-52748-01 44 16 537 (16x)</p>  <p>70-53957-00 16x</p> 	<p>71-53586-00 </p> <p>44 15 282</p>  <p>71-38512-00 </p> <p>44 19 191</p> 		<p>81-53584-00 </p> <p>44 15 083 52x66 FPM</p>  <p>81-90044-00 </p> <p>44 15 044</p> 

OPEL/VAUXHALL

Ltr. 3,0 30 E
 132 kW (180 PS)
 MONZA A
 ROYALE
 SENATOR
 SENATOR A
 02/78-12/86 1

	<p>02-24675-09 16 06 466 +642 530 (6x) → 30 E 31333</p> <p></p> <p>02-24675-10 16 06 466 +642 530 (12x) 30 E 31334 → → 30 E 85748</p> <p></p> <p>02-24675-11 16 06 609 +642 530 (12x) 30 E 85749 →</p> <p></p>	<p>08-12842-03 16 06 665 +614 815</p> <p></p>		<p>61-24675-20 607 982 +638 182 97 Ø 1,1 mm</p> <p></p>	<p>14-32039-02 20 24 152 (7x) +20 24 153 (7x) 30 E 31334 →</p> <p></p>	<p>71-12907-10 607 666 → 30 E 85748</p> <p></p> <p>71-27334-00 607 628 30 E 85749 →</p> <p></p>	<p>12-27431-03 642 452 (6x) +642 530 (6x) → 30 E 31333</p> <p></p> <p>12-27431-04 642 530 (12x) 30 E 31334 →</p> <p></p> <p>40-77344-00 AS 6x 642 452 → 30 E 31333</p> <p></p> <p>70-27431-00 ES 6x 642 530 → 30 E 31333</p> <p></p> <p>70-27431-00 12x 642 530 30 E 31334 →</p> <p></p>	<p>71-24663-20 </p> <p>850 658</p> <p></p>	<p>10-12842-02 16 06 184</p> <p></p>	<p>81-19195-00 K </p> <p>638 187 45x60 A SL RD ACM</p> <p></p> <p>81-20667-30 K </p> <p>90 156 857 77x100 A SL LD FPM</p> <p></p>		

OPEL/VAUXHALL

Ltr. 													
3,0 30 H	110 kW (150 PS)	04/78-07/82					<p>61-24675-20 607 982 +638 182 97 Ø 1,1 mm</p> 		<p>71-12907-10 607 666</p> 	<p>12-27431-03 642 452 (6x) +642 530 (6x) 30 H 8631</p>  <p>6x</p> <p>12-27431-04 642 530 (12x) 30 H 8632→</p>  <p>6x</p> <p>40-77344-00 AS 642 452 30 H 8631</p>  <p>6x</p> <p>70-27431-00 ES 642 530 30 H 8631</p>  <p>12x</p> <p>70-27431-00 642 530 30 H 8632→</p> 	<p>71-20661-20  </p> <p>850 698</p> 	<p>10-12842-02 16 06 184</p> 	<p>81-19195-00 K </p> <p>638 187 45x60 A SL RD ACM</p>  <p>81-20667-30 K </p> <p>90 156 857 77x100 A SL LD FPM</p> 
3,0 4 JX1	117 kW (159 PS)	07/98-08/99	<p>01-53448-01</p> 	<p>02-53448-01</p> 		<p>04-10119-01 </p> 	<p>61-53365-00 56 07 457 96,5 Ø 1,35 mm</p> <p>61-53365-10 56 07 831 96,5 Ø 1,4 mm</p> <p>61-53365-20 56 07 812 96,5 Ø 1,45 mm</p>  <p>1 </p> <p>2 </p> <p>3 </p>	<p>14-32006-01 56 07 451 (18x)</p> 	<p>71-53448-00 56 07 455</p> 	<p>12-53449-01 642 459 (16x)</p> 	<p>71-53441-00 </p> <p>58 50 868</p>  <p>71-53452-00 </p> <p>58 50 870</p>  <p>4x</p>	<p>81-53426-00 K </p> <p>56 36 816 50x68 A SL RD FPM</p>  <p>81-53077-00 K </p> <p>614 839 95x118 A SL LD FPM</p>  <p>81-53221-00 N</p> <p>28x47 A SL RD MVQ</p> 	



OPEL/VAUXHALL															
Ltr.															
3,1	4 JG2TC	84 kW (114 PS)	MONTEREY A TD MONTEREY TD	09/91-07/98	01-52414-01 	02-52414-01 		04-10003-01 	61-53020-00 607 637 96,5 Ø 1,4 mm MLS 61-53020-10 608 629 96,5 Ø 1,45 mm MLS 61-53020-20 608 630 96,5 Ø 1,5 mm MLS 	14-32145-01 607 327 (18x) 	15-52414-02 56 07 441 	12-52834-01 642 543 (8x) 70-52834-00 642 543 	71-52962-00 850 518 71-52963-00 71-52964-00 850 625 	10-52968-01 652 603 +652 606 +652 637 	81-53351-00 95x118 AB SL LD MVQ 81-53268-00 56 36 816 40x56 A SL LD MVQ
3,2	Y 32 SE	160 kW (218 PS)	OMEGA B OMEGA V6	02/01-07/03		02-34430-01 	08-34896-01 16 06 074 		61-34430-00 2x 56 07 466 88,5 Ø 0,6 mm MLS 	14-32104-02 607 256 (16x) 	15-34268-02 2x 607 642 	12-31306-08 2x 642 533 (12x) 70-31306-00 642 533 	71-34241-00 849 510 71-34242-00 849 509 71-34271-00 849 848 71-34244-00 850 506 	70-31414-10 	81-28236-00 646 269 38x50 A SL RD FPM 81-38229-00 614 827 90x104 A SL LD 81-24909-10 56 36 970 35x48 A SL RD MVQ
3,2	Y 32 SE	160 kW (218 PS)	OMEGA B OMEGA V6	02/01-07/03		02-34430-01 	08-34896-01 16 06 074 		61-34430-00 2x 56 07 466 88,5 Ø 0,6 mm MLS 	14-32104-02 607 256 (16x) 	15-38269-01 2x 56 07 833 	12-31306-08 2x 642 533 (12x) 70-31306-00 642 533 	71-34241-00 849 510 71-34242-00 849 509 71-34271-00 849 848 71-34244-00 850 506 	70-31414-10 	81-28236-00 646 269 38x50 A SL RD FPM 81-38229-00 614 827 90x104 A SL LD 81-24909-10 56 36 970 35x48 A SL RD MVQ



OPEL/VAUXHALL																
3,2	Z 32 SE	155 kW (211 PS)	SIGNUM SIGNUM V6 VECTRA C VECTRA II V6	 21-2899999 2199999 21-2899999 2199999	08/02-07/08			 08-34896-01 16 06 074		 61-34430-00 2x 56 07 466 88,5 Ø 0,6 mm MLS	 14-32104-02 607 256 (16x)	 15-34268-02 2x 607 642	 12-31306-11 2x 642 533 (12x)	 71-34271-00 2x 849 848	 70-31414-10	 81-28236-00 K ← 646 269 38x50 A SL RD FPM 81-38229-00 K → 614 827 90x104 A SL LD 81-24909-10 N 4x 56 36 970 35x48 A SL RD MVQ
3,2	Z 32 SE	155 kW (211 PS)	SIGNUM SIGNUM V6 VECTRA C VECTRA II V6	 31-38000001→ 31000001→ 31-38000001→ 31000001→	08/02-07/08			 02-34430-02 2x 16 06 280	 08-34896-01 16 06 074	 61-34430-00 2x 56 07 466 88,5 Ø 0,6 mm MLS	 14-32104-02 607 256 (16x)	 15-38269-01 2x 56 07 833	 12-31306-11 2x 642 533 (12x)	 71-34271-00 2x 849 848	 70-31414-10	 81-28236-00 K ← 646 269 38x50 A SL RD FPM 81-38229-00 K → 614 827 90x104 A SL LD 81-24909-10 N 4x 56 36 970 35x48 A SL RD MVQ
3,2	Z 32 SEE 10 HM	167-169 kW (227-230 PS)	ANTARA		07/06					 61-37220-00 R 48 07 957 MLS	 14-32293-01 2x 56 07 748 (8x)	 71-38171-00 R 642 970	 12-38226-01 2x 642 688 (12x)	 71-38222-00 L ← 58 50 845		 81-38237-00 K ← 646 973 50x70 AB SL RD PTFE 81-90046-00 K → 173x228 A SL LD LD PTFE
								 61-37225-00 L 48 07 956 MLS		 71-38172-00 L 642 969	 70-38226-00 24x 642 688	 71-38174-00 L → 58 50 840	 70-31306-10 24x 642 533			





PEL/VAUXHALL

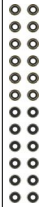

Ltr.  3.2 6VD1 6VD1 (DOHC) 130-151 kW (177-205 PS) FRONTERA II 10/98



61-36195-00 R
56 07 476
MLS

61-36200-00 L
56 07 477
MLS

12-36204-01
642 458 (12x)
+642 435 (12x)

70-36204-00 12x
642 458

70-36206-00 12x
642 535



71-36319-00  2x
850 524

71-36317-00  2x
58 50 871



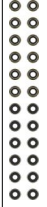

81-36227-00 K 
614 832
95x118
B SL LD FPM



3.5 6VE1 158 kW (215 PS) MONTEREY B MONTEREY II V6 07/98-08/99

61-36195-00 R
56 07 476
MLS

61-36200-00 L
56 07 477
MLS

12-36204-01
642 458 (12x)
+642 435 (12x)

70-36204-00 12x
642 458

70-36206-00 12x
642 535

71-36319-00  2x
850 524

71-36317-00  2x
58 50 871

81-36227-00 K 
614 832
95x118
B SL LD FPM

Haftungsausschluss

(für Katalog)

Alle Angaben in unserem Katalog wurden von uns sorgfältig geprüft, sind jedoch unverbindlich. Ersatzansprüche wegen Katalogangaben werden von uns nicht anerkannt. Der Käufer ist selbst verpflichtet, zu prüfen, ob unsere Teile für seine Zwecke geeignet sind. In allen Zweifelsfällen sollte Rücksprache mit unserem technischen Kundendienst erfolgen **Tel. +49 731 7046 999**.

Technische Weiterentwicklungen oder Änderungen bleiben vorbehalten, soweit damit keine Nachteile für den Kunden verbunden sind.

Angaben, Namens- und Markenzeichen, Beschreibungen, Nummern von Fahrzeugnummern und Herstellerzeichen, Original-Ersatzteilnummern der Fahrzeug- und Motorenhersteller u. a. sind ausschließlich für interne Zwecke gedacht. Solche Kennzeichnungen dürfen Fahrzeugbesitzern gegenüber nicht verwendet werden.

Wir weisen ausdrücklich darauf hin, dass alle von uns gelieferten Teile von geschultem Fachpersonal einzubauen sind. Reinz haftet für Fehler in diesem Katalog nur, wenn diese für den Kunden nicht offenbar erkennbar sind sowie nur bei Vorsatz und grober Fahrlässigkeit von Reinz, eines Vertreters oder eines Erfüllungsgehilfen. Dieser Haftungsausschluss gilt nicht im Rahmen

des Anwendungsbereichs des Produkthaftungsgesetzes und nicht bei Verletzung von Körper, Leben und Gesundheit, sowie bei der Verletzung von sog. Kardinalpflichten. Darüber hinaus ist unsere Haftung für Schäden, insbesondere für Personen-, Sach- oder Vermögensschäden, die unmittelbar oder mittelbar im Zusammenhang mit der Nutzung dieses Kataloges auftreten, sowie für nicht voraussehbare Schäden ausgeschlossen.

Reinz ist Inhaber aller Schutzrechte an den in diesem Katalog gespeicherten Daten. Kopie, Nachdruck, ganze oder teilweise Übernahme der Inhalte und Vervielfältigung, auch auszugsweise, ist nur mit unserer vorheriger schriftlicher Zustimmung sowie mit unserem Urheberrechtsvermerk zulässig.

Für Bestellungen, welche ab dem Erscheinungsdatum eines neuen Katalogs getätigt werden, sind alleine die Angaben des neuen Katalogs maßgeblich. Auf Angaben im Vorkatalog kann bei Neubestellungen nicht mehr zurückgegriffen werden.

Sofern Sie noch Fragen haben, bitten wir Sie, sich mit uns in Verbindung zu setzen.

VictorReinz.com/AGB

Exclusion of Liability

(for catalog)

All details in our catalog have been thoroughly checked by us but are however not binding. Right to damages on account of catalog details will not be recognized. The purchaser is obliged to check if our parts are suitable for their use. In all doubtful cases, the purchaser should consult our technical customer service under **+49 731 7046 999**.

We reserve the right to further technical developments or changes as long as no disadvantage for the customer results.

Details, name and trademarks, descriptions, numbers from vehicle numbers and manufacturer symbols, original vehicle replacement part numbers and engine manufacturer etc. are solely for internal use. Such labels must not be used with vehicle owners.

We specifically point out that all parts supplied by us must be assembled by trained specialists.

Reinz is liable for mistakes in this catalog only when they are not clearly recognizable for the customer, as well as by intent or gross negligence on the part of Reinz, its representative or vicarious agent. This exclusion of liability does not apply within the framework of the field of

application of the product liability laws and not by bodily harm, life and health, as well as by violation of cardinal duties. In addition, our liability for damages, especially personal, property or financial damages that occur directly or indirectly as a result of the use of this catalog, as well as non-foreseeable damages are excluded.

Reinz is the owner of all patent rights on the data stored in this catalog. Copies, reprints, whole or partial takeover of the contents and duplication even in excerpts are only permissible with our prior written approval, as well as with our copyright note.

For orders placed after the publication date of a new catalog, only the details in the new catalog are binding and no fall back to details in the previous catalog is possible.

In case you have further questions, do not hesitate to contact us.

VictorReinz.com/AGB

VictorReinz.com

reinz.info@dana.com

Technical Hotline +49 (0)731 7046-9 99

REINZ-Dichtungs-GmbH

Reinzstrasse 3-7
89233 Neu-Ulm
Germany
+49 (0)731 7046-0

VICTOR REINZ[®]

