

**VICTOR REINZ®**

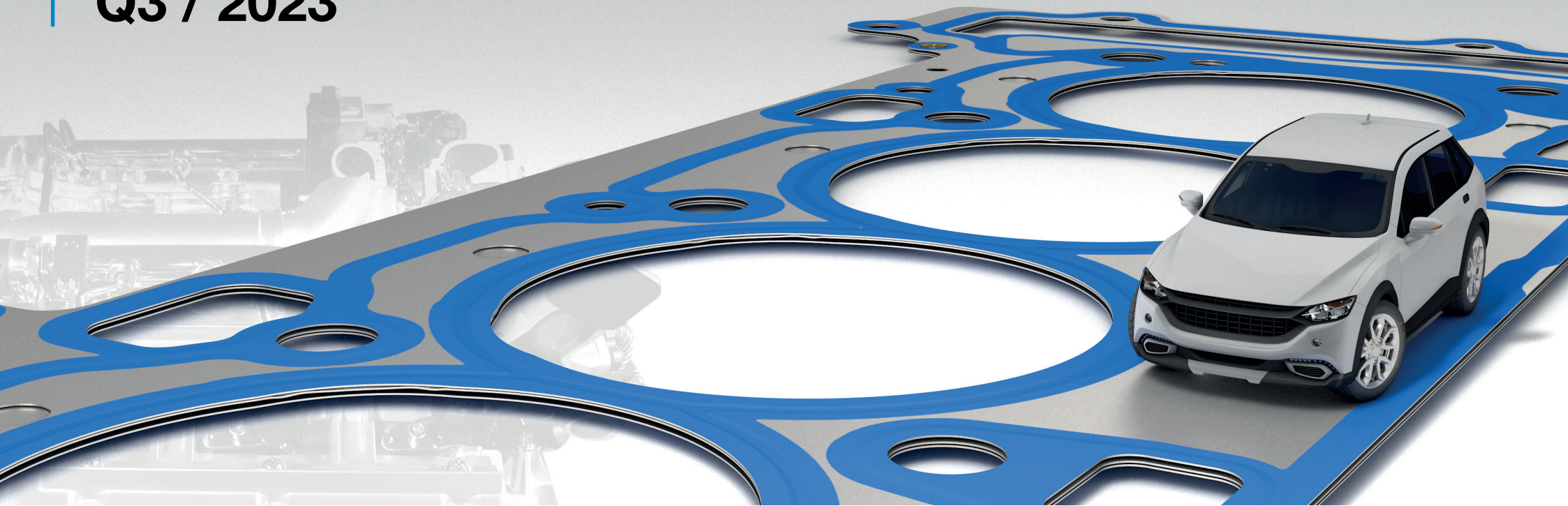

**PEUGEOT  
Q3 / 2023**



**[VictorReinz.com/online-catalog](https://VictorReinz.com/online-catalog)**

# Victor Reinz®

at a Glance



## Online Catalog

[VictorReinz.com/online-catalog](https://VictorReinz.com/online-catalog)



## Newsletter

[VictorReinz.com/EN/News/Newsletter.aspx?region](https://VictorReinz.com/EN/News/Newsletter.aspx?region)



## Youtube

[www.youtube.com/user/VictorReinzSealingEN](https://www.youtube.com/user/VictorReinzSealingEN)



## Catalog News

[VictorReinz.com/news](https://VictorReinz.com/news)



## Technical Service Information

[VictorReinz.com/tsi](https://VictorReinz.com/tsi)



## Facebook

[www.facebook.com/VictorReinzParts](https://www.facebook.com/VictorReinzParts)



## Just seal it!

[VictorReinz.com/jsi](https://VictorReinz.com/jsi)



## Technical Datasheet

[VictorReinz.com/jsi-datasheet](https://VictorReinz.com/jsi-datasheet)



## LinkedIn

[www.linkedin.com/showcase/victor-reinz-emea](https://www.linkedin.com/showcase/victor-reinz-emea)



## Safety Datasheet

[VictorReinz.com/jsi-datasheet](https://VictorReinz.com/jsi-datasheet)



## Homepage

[VictorReinz.com](https://VictorReinz.com)

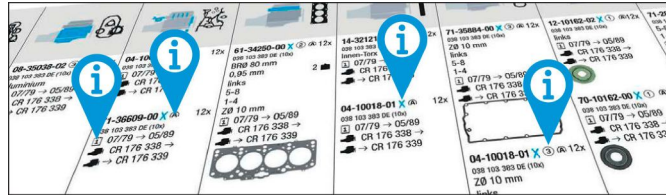

[VictorReinz.com/catalog-info](https://www.victorreinz.com/catalog-info)

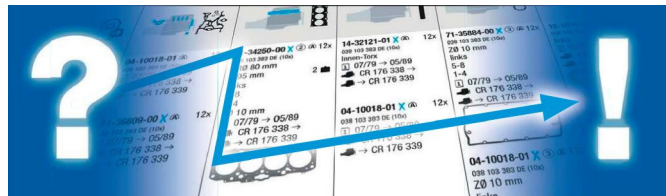

[VictorReinz.com/catalog-how-to-use](https://www.victorreinz.com/catalog-how-to-use)

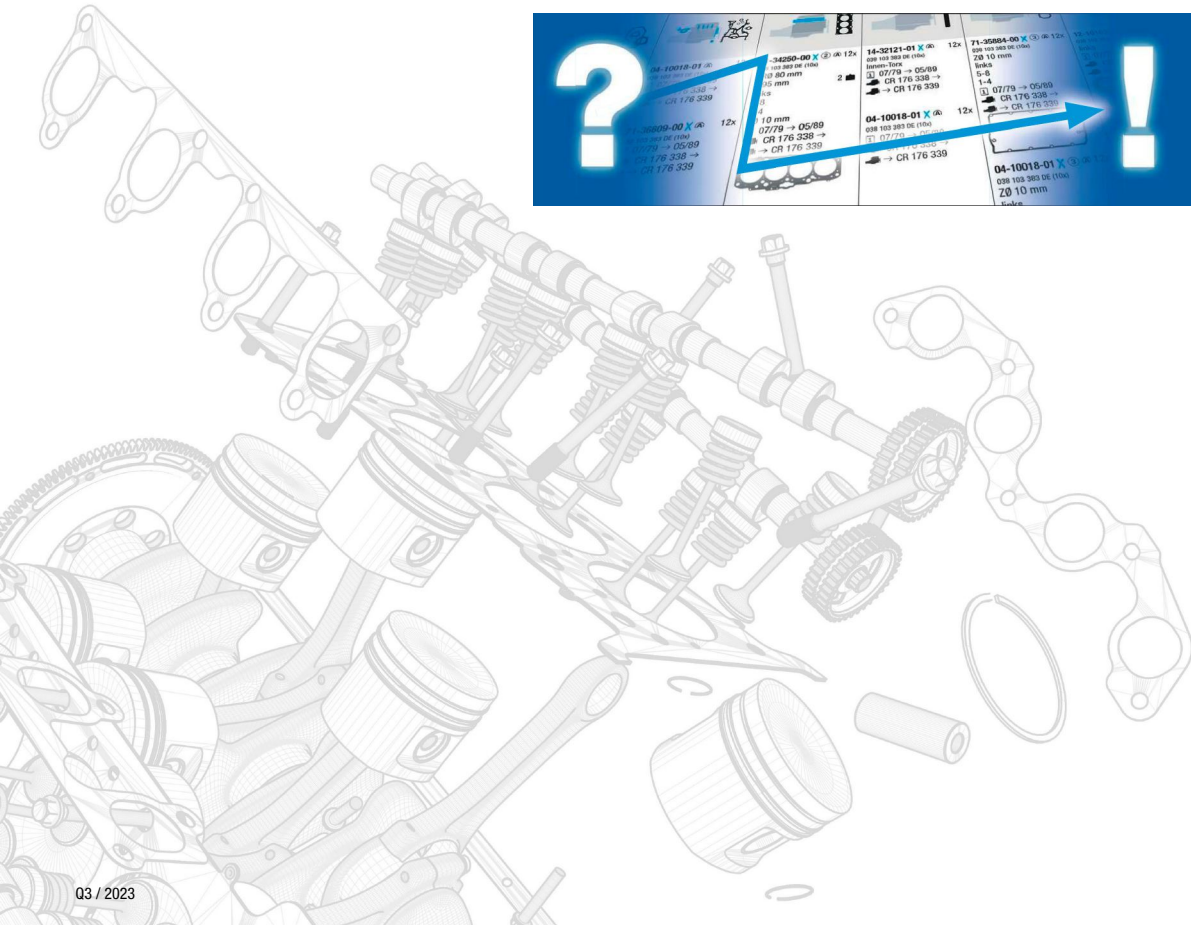

# PEUGEOT



<b>0-9</b>	
1580 SPI (222A2)	38
161 (XUD7)	52
42 D	61
4A92	39
4B11	90
4HA (DW12RUE)	95
4HG (P22DTE)	95
4HG (PUMA C)	95
4HH (DW12RUC)	95
4HH (P22DTE)	95
4HH (PUMA C)	95
4HJ (DW12RUD)	95
4HJ (P22DTE)	95
4HJ (PUMA C)	95
4HK (DW12ME5)	92
4HK (DW12MTED4)	92
4HK (DW12RUE)	95
4HL (DW12C)	92
4HN (DW12MTED4)	92
4HP (DW12BTED4)	92
4HR (DW12BTED4)	92
4HS (DW12BTED4)	92
4HU (P22DTE)	95
4HV (P22DTE)	95
4HW (DW12ATED4)	96
4HW (DW12TED4)	96
4HZ (DW12TED4)	96
5FA (EP6CDT)	39
5FD (EP6DTS)	39
5FE (EP6CDTM)	40
5FE (EP6CDTMD)	40
5FG (EP6CDTR)	40
5FH (EP6C)	40
5FK (EP6CB)	40
5FM (EP6CDTM)	40
5FN (EP6CDT)	41
5FR (EP6DT)	39
5FS (EP6C M)	32
5FS (EP6C)	32
5FT (EP6DT)	39
5FU (EP6CDTX)	32
5FV (EP6CDT)	39
5FW (EP6)	40-41
5FX (EP6DT)	39, 41



5FY (EP6DTS)	39
5GB (EP6FADTXHPA)	30
5GB (EP6FADTXHPR)	30
5GF (EP6FADTXD)	30
5GG (EP6FADTX)	30
5GL (EP6FDTMD)	42
5GM (EP6FDTX)	42
5GN (EP6FDTR)	42
5GP (EP6FDTR)	42
5GQ (EP6FADTXHPD)	30
5GR (EP6FDTX)	43
5GT (EP6FDTX)	42
5GV (EP6FDTM)	42
5GX (EP6FDTMD)	42
5GY (EP6FDTM)	43
5GZ (EP6FDT)	43-44
6HZ (4N13)	57
8140.43	105
8140.43 (F28DT)	105
8140.43N	105
8140.43S	105
8140.43S (F28DTCR)	105
8140.63 (F28D)	106
8140.67	103
8FN (EP3C)	19
8FP (EP3C)	19
8FR (EP3)	19
8FR (EP3C)	19
8FS (EP3)	19
8HP (DV4C)	25
8HR (DV4C)	25
8HS (DV4TED)	25
8HT (DV4TD)	25
9HC (DV6C)	44
9HD (DV6C UE6)	45
9HD (DV6C)	45
9HD (DV6CTED)	45
9HF (DV6DTED)	44
9HF (DV6DU)	44
9HG (DV6C M)	45
9HH (DV6DUM)	44
9HJ (DV6DTEDM)	44
9HK (DV6ETEDM)	45
9HL (DV6C)	46
9HM (DV6UC)	44



9HN (DV6ETED)	44
9HP (DV6DTED)	44
9HR (DV6C)	47
9HS (DV6TED4BU)	48
9HT (DV6BUTED4)	30
9HU (DV6UTED4)	31
9HV (DV6TED4)	30
9HV (DV6TED4B)	30
9HV (DV6TED4BU)	30
9HW (DV6BTED4)	49
9HX (DV6AUTED4)	30
<b>A</b>	
AHH (DW10FC)	68
AHJ (DW10FE)	68
AHK (DW10FE)	68
AHM (DW10FUE)	69
AHN (DW10FUD)	69
AHP (DW10FUC)	69
AHR (DW10FD)	68
AHS (DW10FD)	68
AHV (DW10FD)	68
AHW (DW10FC)	68
AHX (DW10FCD)	68
AHX (DW10FD)	68
AHY (DW10CE)	70
AHZ (DW10CD)	70
<b>B</b>	
BHS (DV6FDU)	29
BHV (DV6FDU)	29
BHW (DV6FE)	29
BHX (DV6FC)	29
BHX (DV6FCU)	29
BHY (DV6FD)	29
BHZ (DV6FC)	29
<b>C</b>	
CFA (384F)	6
CFB (1KR)	6
CRD93	98
CRD93L	98
CRD93LS	99



<b>D</b>	
D2H (XU92C)	60
D4D	7
D5A (XU92C)	60
D8A (XUD9TE)	61
DFV (XU9J2)	58
DGX (EP6FADTXHPE)	30
DGY (EP6FADTXHPD)	30
DJ5 (T9A)	100
DJ5T (T8A)	101
DJ5TED (THX)	101
DJZ (XUD9)	58
DK5ATE (THY)	100
DT17BTED4 (UHZ)	103
DT17TED4	103
DT20C	106
DV4TD (8HX)	18
DV4TD (8HZ)	18
DV6ATED4 (9HX)	30
DV6BTED4 (9HT)	31
DV6TED4 (9HY)	30
DV6TED4 (9HZ)	30
DW10ATED (RHS)	70
DW10ATED (RHZ)	70
DW10ATED4 (RHM)	71
DW10ATED4 (RHT)	71
DW10ATED4 (RHW)	71
DW10BTED (RHX)	71
DW10BTED4 (RHR)	72
DW10CTED4 (RHH)	70
DW10TD (RHY)	70
DW10UTD (RHW)	72
DW10UTED4 (RHK)	73
DW12BTED4 (4HT)	92
DW12TED4 (4HX)	93
DW12UTED (4HY)	93
DW8 (WJZ)	59
DW8B (WJY)	59
<b>E</b>	
E1	8
EC5F	31
EGX (EP6FADTR)	32
EHS (DW10FDDU370)	68
EHT (DW10FDDU340)	68

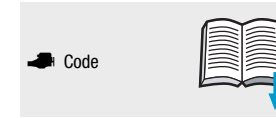

EHY (DW10FCC)	68
EHZ (DW10FC)	74
EHZ (DW10FDCU)	68
EN 55	102
EP3	19
EP3C	19
EP6	32
EP6CDTX	32
ES9A (XFV)	107
ES9J4 (XFZ)	107
ES9J4S (XFJ)	108
ET 70	102
ET3J4 (KFU)	19
EW10 (RFH)	74
EW10A (RFJ)	74
EW10D (RLZ)	75
EW10J4 (RFN)	75
EW10J4S (RFK)	76
EW12J4 (3FY)	94
EW12J4 (3FZ)	94
EW7A (6FY)	50
EW7J4 (6FZ)	50
<b>F</b>	
F1	13
F1AE0481T	96
F1CE0481D (F30DT)	109
F1CE0481D (F30DTE)	108
F1CE0481D (F30DTE)	108
F1CE3481E (F30DTE)	109
F1CE3481N (F30DTE)	109
FHY (F13DTE6)	16
FHZ (F13DTE5)	16
<b>G</b>	
G1A	16
GCR (EP6FADTX)	32
GFR (EP6FADTXD)	32
GGR (EP6FADTX)	32
<b>H</b>	
HDY (TU1M+)	9
HDZ (TU1M+)	9
HFX (TU1A)	10
HFY (TU1JP)	10

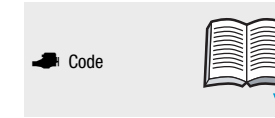

HMH (EB2FAD)	14
HMJ (EB2FAM)	14
HMM (EB2FAD)	14
HMP (EB2FB)	14
HMR (EB2FA)	14
HMT (EB2D)	14
HMX (EB2)	14
HMY (EB2M)	14
HMZ (EB2)	14
HMZ (EB2F)	14
HNJ (EB2ADTXM)	14
HNK (EB2ADT)	14
HNK (EB2ADTD)	14
HNL (EB2ADTSM)	14
HNM (EB2ADTM)	14
HNN (EB2ADTX)	14
HNP (EB2ADT)	14
HNR (EB2ADTXM)	14
HNS (EB2ADTS)	14
HNT (EB2ADTS)	14
HNV (EB2DTM)	15
HNW (EB2DTSM)	15
HNX (EB2DTS)	15
HNY (EB2DTS)	15
HNZ (EB2DT)	15
<b>K</b>	
KF5	51
KF6	51
KFT (TU3A)	20
KFT (TU3AE5)	20
KFW (TU3A)	21
KFZ (TU3FJ2/Z)	21
<b>L</b>	
L6A (XU7JP)	51
<b>N</b>	
NFJ (EC5F)	31
NFP (EC5)	31, 33
NFP (EC5F)	31
NFR (TU5JP4B)	33
NFT (TU5JP)	34



<b>R</b>	
R6A (XU10J2)	79
RFM (EW10J4)	76
RFR (EW10J4)	75
RGX (XU10J2CTE)	77
RHA (DW10CTED4)	70
RHC (DW10CTED4)	70
RHD (DW10CB)	70
RHD (DW10CTED4)	70
RHE (DW10CTED4)	70
RHF (DW10BTED4)	77
RHL (DW10BTED4)	72
RHR (DW10CB)	70
RHV (DW10TD)	72
RHZ (DW10BTED)	78
RHZ (DW10BTED+)	72
RHZ (DW10CTED)	79
<b>S</b>	
SFY (4B12-MMC)	97
SFZ (4B12-MMC)	97
<b>T</b>	
TU1 (H1B)	9, 11
TU1AE5	11
TU1JP (HFJ)	10
TU1JP (HFZ)	10
TU1M (HDY)	9
TU1M (HDZ)	9, 11
TU24	17
TU2J2	17
TU32	23
TU3A (K1D)	23
TU3A (KFV)	22
TU3CP (KAY)	23
TU3JP (KFV)	21
TU3JP (KFW)	21
TU3JP (KFX)	21
TU3M (KDY)	23
TU3M (KDZ)	23
TU3MC (KDX)	23
TU3S (K2B)	23
TU5J2 (NFW)	34
TU5J2 (NFY)	34
TU5J4 (NFX)	35

# PEUGEOT



**Code**

TU5JP (NFZ) .....	34
TU5JP4 (N6A) .....	33
TU5JP4 (NFU) .....	35
TU9 .....	7
TU9M (CDY) .....	7
TU9M (CDZ) .....	7
TUD3 (K9Y) .....	22
TUD5 (VJX) .....	26
TUD5 (VJY) .....	26

**U**

UHZ (DT17TED4) .....	103
----------------------	-----

**V**

VJZ (TUD5) .....	26
------------------	----

**X**

XB5 .....	26
XB5P .....	26
XC5P .....	35
XC6 .....	35
XC7P .....	36
XD2 ( 134) .....	97
XD2P94 .....	97
XD2PX94 .....	97
XD2S .....	97
XD2S (147) .....	97
XD3 (155) .....	102
XD3P .....	102
XD3T .....	103
XD3T (152A) .....	103
XD3TE .....	103
XD3TE (152B) .....	103
XD4X88 .....	61
XD4x90 .....	91
XDP 4.90 .....	91
XDP88 .....	61
XDP90 .....	91
XDIX90 .....	91
XID (149) .....	27
XK .....	11
XK4 .....	11
XK5 .....	12
XL3 .....	17
XL3S .....	17



**Code**

XL4D .....	18, 23
XL5 .....	18
XL5 (118) .....	18
XL5S .....	18
XLD .....	15
XM .....	51
XM7 .....	51
XM7P .....	51
XN1 .....	80-81
XN1 (106) .....	80
XN1A (106E) .....	80
XN1P .....	81
XN1T .....	81
XN1T (170) .....	81-82
XN1T (170B) .....	82
XN1TA .....	82
XN1TA (170C) .....	82
XN2 (107) .....	82
XR5 (142) .....	27
XR5A (142) .....	27
XR5S (117) .....	27
XU102C (R5A) .....	90
XU10J2 (RFU) .....	83
XU10J2 (RFW) .....	83
XU10J2 (RFX) .....	84
XU10J2TE (RGX) .....	84
XU10J2TE (RGY) .....	84
XU10J2U (RFL) .....	83
XU10J2Z (RFZ) .....	85
XU10J4 (RFT) .....	85
XU10J4R (RFV) .....	86-88
XU10J4RS (RFS) .....	89
XU10J4TE/Z (RGZ) .....	85
XU10J4Z (RFY) .....	85
XU10MZ .....	89
XU51C (B1A) .....	36-37
XU51C (B1D) .....	37
XU51C (B1E) .....	36-37
XU52C/K (B2A) .....	36
XU5CP (BAZ) .....	36-37
XU5J (180A) .....	36-37
XU5J (180Z) .....	36-37
XU5J (B6B) .....	37
XU5JP (BFZ) .....	37
XU5M (BDY) .....	36



**Code**

XU5M (BDZ) .....	36
XU5S (171) .....	36-38
XU7JB (LFX) .....	53
XU7JP (LFW) .....	53
XU7JP (LFZ) .....	51, 54-55
XU7JP4 (LFY) .....	56
XU92C (D2A) .....	60
XU92C (D2C) .....	60, 65
XU9J1 (DFZ) .....	60, 65
XU9J2 (D6A) .....	58
XU9J4 (D6C) .....	67
XU9J4Z (DFW) .....	67
XU9JA (D6B) .....	60, 65-66
XU9JAZ (DKZ) .....	60
XU9M (DDZ) .....	60
XU9S (159) .....	65, 68
XU9S (D2B) .....	65
XUD11A (P9A) .....	91
XUD11ATE (PHZ) .....	92
XUD11BTE (P8C) .....	92
XUD7 (161A) .....	52
XUD7 (A9A) .....	52
XUD7T .....	52
XUD7TE (A8A) .....	52
XUD7TE (A8B) .....	52
XUD7TE (AJZ) .....	52
XUD9 .....	58
XUD9 (162) .....	58
XUD9 (D9A) .....	62
XUD9 (DJZ) .....	58
XUD9A (D9B) .....	63
XUD9A (DJY) .....	63
XUD9AU (D8C) .....	63
XUD9BSD (D8V) .....	61
XUD9TE .....	61
XUD9TE (D8B) .....	64
XUD9TE (DHX) .....	61, 64
XUD9TE (DHY) .....	61
XUD9UTF (D8C) .....	61
XV3 (108) .....	6
XV5 (108) .....	6
XV8 (108C) .....	8
XW3 (109) .....	12
XW3S .....	12
XW3S (121) .....	12



**Code**

XW7 (109F) .....	13
XW7 (109N) .....	13
XY6B (150) .....	24
XY7 (150D) .....	24
XY7 (150G) .....	24
XY8 (150B) .....	24
XY8 (150H) .....	24
XZ5 (129) .....	15



















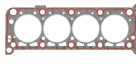











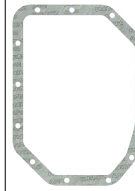









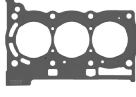

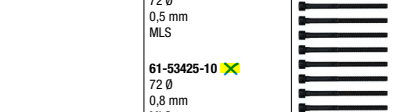
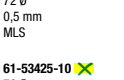

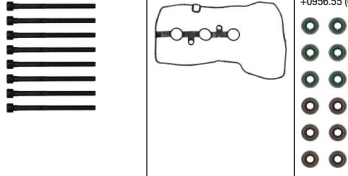
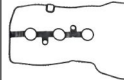



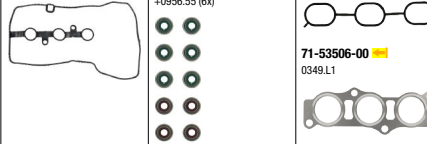
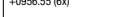

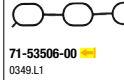







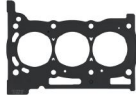

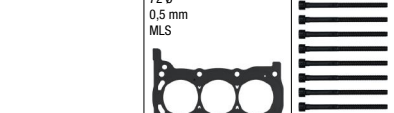



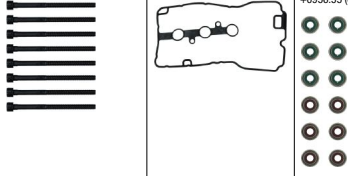

**Y**

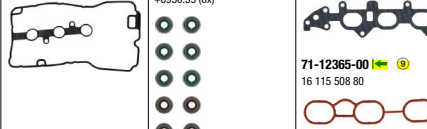
Y2/K .....	24, 28
YHR (DV5RUCd) .....	27
YHS (DV5RCE) .....	27
YHT (DV5RCF) .....	27
YHV (DV5RUC) .....	27
YHW (DV5RE) .....	28
YHX (DV5RC) .....	27
YHY (DV5RD) .....	28
YHZ (DV5RC) .....	27

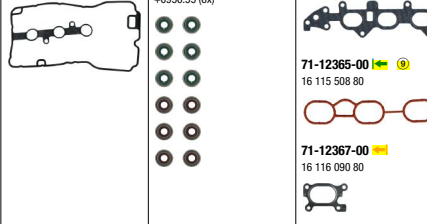
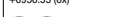
**Z**













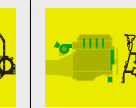

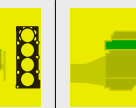

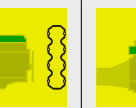
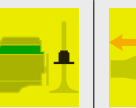
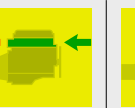

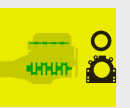
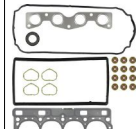
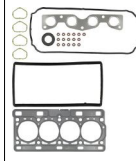

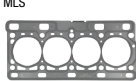
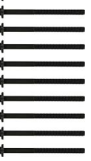

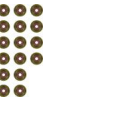
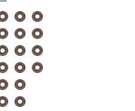

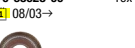



ZDJ (851) .....	94
ZDJL (851B) .....	94
ZDJL (851X) .....	94
ZEJ (829) .....	90
ZM (112) .....	104
ZMJ (140) .....	104
ZMZ (EB0) .....	8
ZN3J (154X) .....	104
ZPJ (UFZ) .....	109
ZPJ4 (UKZ) .....	110

PEUGEOT











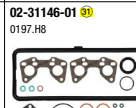
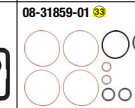
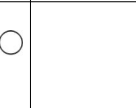
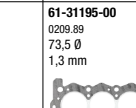
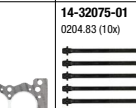
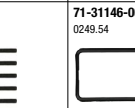
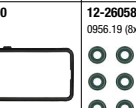
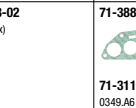

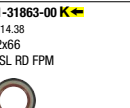







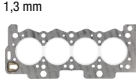









<p>Ltr.   </p> <p>0,9 XV3 (108) XV5 (108)</p> <p>33-34 kW (45-46 PS)</p> <p>104</p> <p>10/72-10/83</p>		 <p>02-22970-02 0198.58</p>	 <p>08-23542-01 0197.76</p> 		 <p>61-22970-10 0203.84 74 Ø 1,2 mm</p> 		 <p>71-23307-00 0249.39</p> 	 <p>12-25837-01 0956.22 (8x)</p> 	 <p>71-25149-10  0348.54</p>  <p>71-23308-20  0349.C4</p> <p>8x </p>	 <p>71-23542-30 0304.46</p> 	 <p>81-21798-30  0236.14 35x50 A SL WD ACM</p>  <p>81-23578-30  0514.14 78x100 A LD MVQ</p> 
<p>1,0 CFA (384F) CFB (1KR)</p> <p>50 kW (68 PS)</p> <p>107</p> <p>06/05-05/14</p>	 <p>01-53425-04 16 135 167 80</p>	 <p>02-53425-04 16 134 970 80</p>	 <p>61-53425-00 0209.EC 72 Ø 0,5 mm MLS</p> <p>61-53425-10  72 Ø 0,8 mm MLS</p> 	 <p>14-32366-01 6822.JC (8x)</p> 	 <p>71-53503-00 0249.C9</p> 	 <p>12-53507-01 0956.54 (6x) +0956.55 (6x)</p> 	 <p>71-53504-00  16 089 478 80</p>  <p>71-53506-00  0349.L1</p> 	 <p>70-31414-10</p> 	 <p>81-53508-30  0321.97 38x50 A SL RD FPM/ACM</p>  <p>81-53509-00  16 128 780 80 74x89 A SL LD MVQ</p> 		
<p>1,0 CFB (1KR)</p> <p>51 kW (69 PS)</p> <p>108</p> <p>05/14</p>	 <p>01-10200-01 16 132 965 80</p>	 <p>02-10200-01 16 115 537 80</p>	 <p>61-10200-00 16 115 414 80 72 Ø 0,5 mm MLS</p> 	 <p>14-32366-01 6822.JC (8x)</p> 	 <p>71-13091-00 16 115 421 80</p> 	 <p>12-53507-01 0956.54 (6x) +0956.55 (6x)</p> 	 <p>71-12366-00  16 115 509 80</p>  <p>71-12365-00  16 115 508 80</p>  <p>71-12367-00  16 116 090 80</p> 	 <p>70-31414-10</p> 	 <p>81-53508-30  0321.97 38x50 A SL RD FPM/ACM</p>  <p>81-53509-00  16 128 780 80 74x89 A SL LD MVQ</p> 		

PEUGEOT

Ltr.  1,0 D4D 52 kW (71 PS) 206 16V 06/01-12/05

											
	<p><b>02-33740-01</b> 1 07/03</p>  <p><b>02-33740-02</b> 1 08/03→</p> 	<p><b>08-33366-02</b> 1 07/03</p>  <p><b>08-34461-01</b> 1 08/03→</p> 		<p><b>61-33740-00</b> 70 Ø MLS</p> 	<p><b>14-32232-01</b></p> 	<p><b>71-33371-00</b></p> 	<p><b>12-35241-01</b> 1 07/03</p>  <p><b>12-38628-01</b> 1 08/03→</p>  <p><b>70-35241-00</b> 1 07/03</p>  <p><b>70-38628-00</b> 1 08/03→</p> 	<p><b>11-35242-01</b> </p>  <p><b>71-38626-00</b> </p> 	<p><b>70-31414-10</b></p> 	<p><b>81-33360-00 K</b> </p> <p>32x44 A SL RD FPM 1 07/03</p>  <p><b>81-34461-00 K</b> </p> <p>32x44 A SL RD PTFE ACM 1 08/03→</p>  <p><b>81-33365-00 K</b> </p> <p>70x86 A SL LD FPM 1 07/03</p>  <p><b>81-34462-00 K</b> </p> <p>70x86 A SL LD PTFE ACM 1 08/03→</p>  <p><b>81-35239-00 N</b></p> <p>28x47 A SL RD FPM/ACM</p> 	

1,0 TU9 TU9M (CDY) TU9M (CDZ) 32-37 kW (44-50 PS) 106 205 08/87-03/01

											
	<p><b>02-31146-01</b> </p> <p>0197.H8</p>  <p><b>02-31195-01</b> 0197.H6 +0209.89</p> 	<p><b>08-31859-01</b> </p>  <p><b>08-33674-01</b> </p> 		<p><b>61-31195-00</b> 0209.89 73.5 Ø 1,3 mm</p> 	<p><b>14-32075-01</b> 0204.83 (10x)</p> 	<p><b>71-31146-00</b> 0249.54</p> 	<p><b>12-26058-02</b> 0956.19 (8x)</p>  <p><b>70-26058-00</b> 0956.19</p> 	<p><b>71-38817-00</b> </p> <p>0349.A6</p>  <p><b>71-31147-00</b> </p> <p>0349.A6</p>  <p><b>71-31862-00</b>  </p> <p>1709.10</p> 	<p><b>70-31414-10</b></p>  <p><b>71-33674-00</b> </p> 	<p><b>81-31863-00 K</b> </p> <p>0514.38 42x66 A SL RD FPM</p>  <p><b>81-23708-50 K</b> </p> <p>0514.74 85x105 A SL LD FPM</p>  <p><b>81-26244-10 N</b></p> <p>0236.21 36x50 A RD ACM</p>  	

PEUGEOT														
Ltr.														
1,0	XV8 (108C)	32-33 kW (44-45 PS)	104 205	02/83-06/88										
					02-22970-02 0198.58	08-23542-01 0197.76		61-22970-10 0203.84 74 Ø 1,2 mm		71-23307-00 0249.39	12-25837-01 0956.22 (8x)	71-25149-10 0348.54	71-23542-30 0304.46	81-21798-30 0236.14 35x50 A SL WD ACM  81-23578-00 0514.14 78x100 A LD MVQ
1,0	ZMZ (EBO)	50 kW (68 PS)	208	03/12-12/19		02-37750-01	08-10153-01	61-37750-00 96 761 487 80 72,5 Ø 0,7 mm MLS	14-10026-01 1608378180	15-11549-01 96 778 553 80	12-12155-01 16 112 897 80	11-11551-01 16 087 337 80	70-31414-10 	81-41219-00 16 140 859 80 61x75 A SL RD PTFE (Polytetrafluorethylen)/ACM (Polyacryl-Kautschuk)  81-10461-00 16 111 874 80
1,1	E1	40 kW (54 PS)	205 309	10/85-07/89						71-12902-00 0249.53	12-25837-01 0956.22 (8x)	71-24161-01 0348.80	71-21718-00 0304.32	













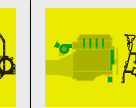

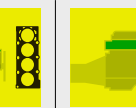

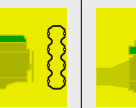
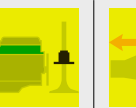
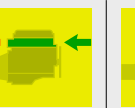

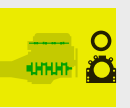
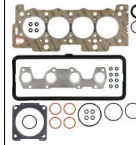
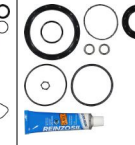

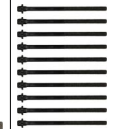





PEUGEOT











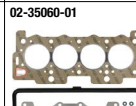
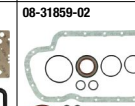
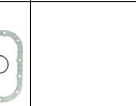
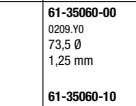
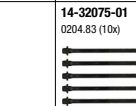
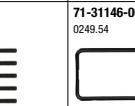
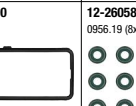
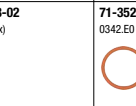
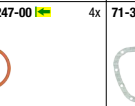
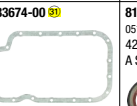
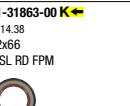
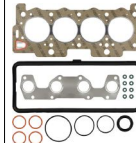
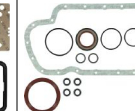

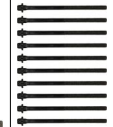









Ltr.	Motor	Power	Model	Year	Image 1	Image 2	Image 3	Image 4	Image 5	Image 6	Image 7	Image 8	Image 9	Image 10	Image 11	
1,1	HDY (TU1M+) TU1 (H1B) TU1M (HDY) TU1M (HDZ)	40-44 kW (54-60 PS)	PARTNER 106 205 306	10/87-09/05												
						<p><b>02-31146-01</b> </p> <p>0197.H8</p> <p><b>02-31200-01</b> </p> <p>0197.H8 +0209.CJ</p>	<p><b>08-33674-01</b> </p>		<p><b>61-33715-00</b></p> <p>0209.CJ 76 Ø 1,3 mm</p> <p><b>61-33715-10</b></p> <p>0209.CK 76 Ø 1,5 mm</p>	<p><b>14-32075-01</b></p> <p>0204.83 (10x)</p>	<p><b>71-31146-00</b></p> <p>0249.54</p>	<p><b>12-26058-02</b></p> <p>0956.19 (8x)</p> <p><b>70-26058-00</b></p> <p>0956.19</p>	<p><b>71-38817-00</b> </p> <p>0349.A6</p> <p><b>71-31147-00</b> </p> <p>0349.A6</p> <p><b>71-31862-00</b> </p> <p>1709.10</p>	<p>2x</p> <p>2x</p> <p>8x</p>	<p><b>71-33674-00</b> </p>	<p><b>81-31863-00</b> </p> <p>0514.38 42x66 A SL RD FPM</p> <p><b>81-23708-50</b> </p> <p>0514.74 85x105 A SL LD FPM</p> <p><b>81-26244-10</b> <b>N</b></p> <p>0236.21 36x50 A RD ACM</p>
1,1	HDZ (TU1M+)	42-44 kW (57-60 PS)	106	04/96-07/04												
						<p><b>02-31146-02</b> </p> <p>0197.J0</p> <p><b>02-31200-01</b> </p> <p>0197.H8 +0209.CJ</p>	<p><b>08-33674-01</b> </p>		<p><b>61-33715-00</b></p> <p>0209.CJ 76 Ø 1,3 mm</p> <p><b>61-33715-10</b></p> <p>0209.CK 76 Ø 1,5 mm</p>	<p><b>14-32075-01</b></p> <p>0204.83 (10x)</p>	<p><b>71-31146-00</b></p> <p>0249.54</p>	<p><b>12-26058-02</b></p> <p>0956.19 (8x)</p> <p><b>70-26058-00</b></p> <p>0956.19</p>	<p><b>71-38817-00</b> </p> <p>0349.A6</p> <p><b>71-31147-00</b> </p> <p>0349.A6</p> <p><b>71-31862-00</b> </p> <p>1709.10</p>	<p>2x</p> <p>2x</p> <p>8x</p>	<p><b>71-33674-00</b> </p>	<p><b>81-31863-00</b> </p> <p>0514.38 42x66 A SL RD FPM</p> <p><b>81-23708-50</b> </p> <p>0514.74 85x105 A SL LD FPM</p> <p><b>81-26244-10</b> <b>N</b></p> <p>0236.21 36x50 A RD ACM</p>

PEUGEOT

























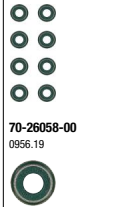





















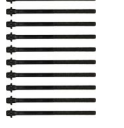

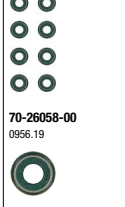









Ltr.  1,1 HFX (TU1A) 44 kW (60 PS) 206 01/09-06/13

											
	<p><b>02-35060-02</b></p> 	<p><b>08-38532-02</b></p> 		<p><b>61-35060-00</b> 0209.Y0 73,5 Ø 1,25 mm</p> <p><b>61-35060-10</b> 0209.Y1 73,5 Ø 1,5 mm</p> 	<p><b>14-32075-01</b> 0204.83 (10x)</p> 	<p><b>71-31146-00</b> 0249.54</p> 	<p><b>12-26058-02</b> 0956.19 (8x)</p> <p><b>70-26058-00</b> 0956.19</p> 	<p><b>71-35247-00</b>  </p> <p>0342.E0</p>  <p><b>71-35068-00</b> </p> <p>0349.K1</p> <p>8x </p>	<p><b>70-31414-10</b></p> 	<p><b>81-38533-00</b> </p> <p>0514.A3 42x66 A SL RD PTFE (Polytetrafluorethylen)/ACM (Polyacryl-Kautschuk)</p>  <p><b>81-38532-00</b> </p> <p>0514.A2 85x105 A SL LD PTFE (Polytetrafluorethylen)/ACM (Polyacryl-Kautschuk)</p>  <p><b>81-39633-00</b> <b>N</b></p> <p>0807.32 36x50 A SL RD PTFE ACM</p> 	



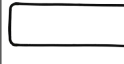
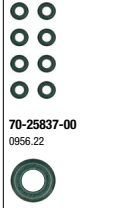



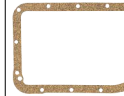







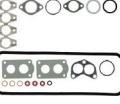
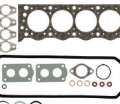









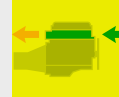











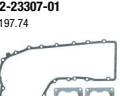

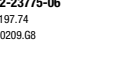

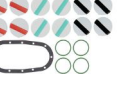





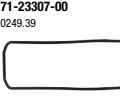

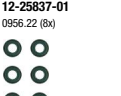







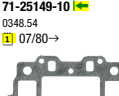
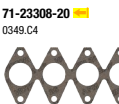

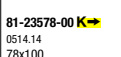



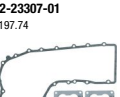







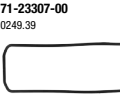

1,1 HFY (TU1.JP) 40-44 kW (54-60 PS) PARTNER 05/96-06/13  
TU1.JP (HFZ) 106  
206  
206 SW

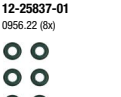
											
	<p><b>02-35060-01</b></p> 	<p><b>08-31859-02</b></p> 		<p><b>61-35060-00</b> 0209.Y0 73,5 Ø 1,25 mm</p> <p><b>61-35060-10</b> 0209.Y1 73,5 Ø 1,5 mm</p> 	<p><b>14-32075-01</b> 0204.83 (10x)</p> 	<p><b>71-31146-00</b> 0249.54</p> 	<p><b>12-26058-02</b> 0956.19 (8x)</p> <p><b>70-26058-00</b> 0956.19</p> 	<p><b>71-35247-00</b>  </p> <p>0342.E0</p>  <p><b>71-33774-00</b>  </p> <p>0349.J6</p> <p>8x </p> <p><b>71-35068-00</b> </p> <p>0349.K1</p>  <p><b>71-36469-00</b>  </p> <p>1709.25</p> 	<p><b>71-33674-00</b> </p> 	<p><b>81-31863-00</b> </p> <p>0514.38 42x66 A SL RD FPM</p>  <p><b>81-23708-50</b> </p> <p>0514.74 85x105 A SL LD FPM</p>  <p><b>81-34403-00</b> <b>N</b></p> <p>0236.44 36x50 A SL FPM</p> 	

PEUGEOT

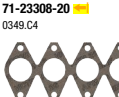
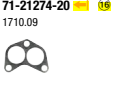
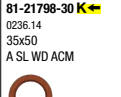
<p>Ltr.  <b>1</b></p> <p>1,1 TU1 (H1B) TU1M (HDZ)</p> <p>40-44 kW (54-60 PS)</p> <p>205 309 405</p> <p>08/87-09/98</p>		<p><b>02-31146-01</b> </p> <p>0197.H8</p>  <p><b>02-31200-01</b> </p> <p>0197.H8 +0209.CJ</p> 	<p><b>08-31859-01</b> </p>  <p><b>08-33674-01</b> </p> 		<p><b>61-33715-00</b></p> <p>0209.CJ 76 Ø 1,3 mm</p> <p><b>61-33715-10</b></p> <p>0209.CK 76 Ø 1,5 mm</p> 	<p><b>14-32075-01</b></p> <p>0204.83 (10x)</p> 	<p><b>71-31146-00</b></p> <p>0249.54</p> 	<p><b>12-26058-02</b></p> <p>0956.19 (8x)</p>  <p><b>70-26058-00</b></p> <p>0956.19</p> 	<p><b>71-38817-00</b> </p> <p>2x</p>  <p><b>71-31147-00</b> </p> <p>0349.A6</p>  <p><b>71-31862-00</b>  </p> <p>1709.10</p> 	<p><b>70-31414-10</b></p>  <p><b>71-33674-00</b> </p> 	<p><b>81-31863-00</b> </p> <p>0514.38 42x66 A SL RD FPM</p>  <p><b>81-23708-50</b> </p> <p>0514.74 85x105 A SL LD FPM</p>  <p><b>81-26244-10</b> </p> <p>0236.21 36x50 A RD ACM</p> 
<p>1,1 TU1AE5</p> <p>44 kW (60 PS)</p>		<p><b>02-35060-02</b></p> 	<p><b>08-38532-02</b></p> 		<p><b>61-35060-00</b></p> <p>0209.Y0 73,5 Ø 1,25 mm</p> <p><b>61-35060-10</b></p> <p>0209.Y1 73,5 Ø 1,5 mm</p> 	<p><b>14-32075-01</b></p> <p>0204.83 (10x)</p> 	<p><b>71-31146-00</b></p> <p>0249.54</p> 	<p><b>12-26058-02</b></p> <p>0956.19 (8x)</p>  <p><b>70-26058-00</b></p> <p>0956.19</p> 	<p><b>71-35247-00</b> </p> <p>0342.E0</p>  <p><b>71-35068-00</b> </p> <p>0349.K1</p>  <p><b>71-42093-00</b>  </p> <p>1709.33</p> 	<p><b>70-31414-10</b></p> 	<p><b>81-38532-00</b> </p> <p>0514.A3 42x66 A SL RD PTFE (Polytetrafluorethylen)/ACM (Polyacryl-Kautschuk)</p>  <p><b>81-38532-00</b> </p> <p>0514.A2 85x105 A SL LD PTFE (Polytetrafluorethylen)/ACM (Polyacryl-Kautschuk)</p>  <p><b>81-39633-00</b> </p> <p>0807.32 36x50 A SL RD PTFE ACM</p> 
<p>1,1 XK XK4</p> <p>39-40 kW (53-55 PS)</p> <p>204</p> <p>10/65-10/77</p>							<p><b>71-20601-00</b></p> <p>0249.21</p> 	<p><b>12-25837-01</b></p> <p>0956.22 (8x)</p>  <p><b>70-25837-00</b></p> <p>0956.22</p> 	<p><b>71-24251-20</b> </p> <p>0349.23</p> 	<p><b>71-12951-00</b></p> <p>0304.09</p> 	

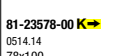
PEUGEOT

<p>Ltr.  XK5</p> <p>43 kW (58 PS)</p> <p>204 304 305</p> <p> 09/75-12/88</p>		 <p><b>02-20601-01</b> 0197.92</p>  <p><b>02-23785-05</b> 0197.92 +0209.G7</p> 			 <p><b>61-23775-40</b> 0209.83 80,5 Ø 1,3 mm</p> 	 <p><b>14-32081-01</b> 0204.36 (10x)</p>	 <p><b>71-20601-00</b> 0249.21</p> 	 <p><b>12-25837-01</b> 0956.22 (8x)</p>  <p><b>70-25837-00</b> 0956.22</p> 	 <p><b>71-24251-20</b>  0349.23</p>  <p><b>40-00996-00</b>  1710.11</p>  <p>8x</p>	 <p><b>71-12951-00</b> 0304.09</p> 	 <p><b>81-21649-00</b>  2074.07 40x49,6 A OD MVQ</p>  <p><b>81-21651-00</b>  2109.06 60,5x78 A RD MVQ</p> 
<p>1,1 XW3 (109)</p> <p>42 kW (57 PS)</p> <p>104</p> <p>07/76-06/83</p>		 <p><b>02-23307-01</b> 0197.74</p>  <p><b>02-23775-06</b> 0197.74 +0209.G8</p> 	 <p><b>08-23542-01</b> 0197.76</p> 		 <p><b>61-23775-20</b> 0209.G8 76 Ø 1,2 mm 16 mm</p> 	 <p><b>71-23307-00</b> 0249.39</p> 	 <p><b>12-25837-01</b> 0956.22 (8x)</p>  <p><b>70-25837-00</b> 0956.22</p> 	 <p><b>71-25149-10</b>  0348.54  07/80→</p>  <p><b>71-23308-20</b>  0349.C4</p>  <p><b>71-21274-20</b>  1710.09  06/80</p>  <p>8x</p>	 <p><b>71-23542-30</b> 0304.46</p> 	 <p><b>81-21798-30</b>  0236.14 35x50 A SL WD ACM</p>  <p><b>81-23578-00</b>  0514.14 78x100 A LD MVQ</p> 	
<p>1,1 XW3S XW3S (121)</p> <p>48-49 kW (66-67 PS)</p> <p>104</p> <p>09/73-06/80</p>		 <p><b>02-23307-01</b> 0197.74</p>  <p><b>02-23775-06</b> 0197.74 +0209.G8</p> 	 <p><b>08-23542-01</b> 0197.76</p> 		 <p><b>61-23775-20</b> 0209.G8 76 Ø 1,2 mm 16 mm</p> 	 <p><b>71-23307-00</b> 0249.39</p> 	 <p><b>12-25837-01</b> 0956.22 (8x)</p>  <p><b>70-25837-00</b> 0956.22</p> 	 <p><b>71-23308-20</b>  0349.C4</p>  <p><b>71-21274-20</b>  1710.09</p>  <p>8x</p>	 <p><b>71-23542-30</b> 0304.46</p> 	 <p><b>81-21798-30</b>  0236.14 35x50 A SL WD ACM</p>  <p><b>81-23578-00</b>  0514.14 78x100 A LD MVQ</p> 	

PEUGEOT

Ltr.  1,1 XW7 (109F) 36-37 kW (49-50 PS) 104 08/79-10/90  
 XW7 (109N) 205

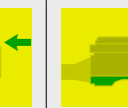
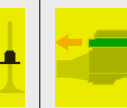
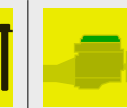
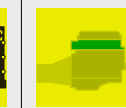

02-23307-01  
0197.74

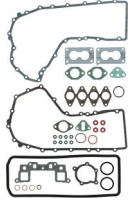

02-23775-06  
0197.74  
+0209.G8

02-27265-02  
0197.75  
+0209.A6

08-23542-01  
0197.76



61-23775-20  
0209.G8  
76 Ø  
1,2 mm  
16 mm



61-27265-10  
0209.A6  
76 Ø  
1,3 mm  
14 mm



71-23307-00  
0249.39

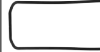



12-25837-01  
0956.22 (8x)



70-25837-00  
0956.22



71-25149-10   
0348.54





71-23308-20   
0349.C4

8x



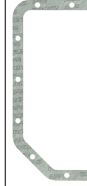

71-23542-30  
0304.46



81-21798-30   
0236.14  
35x50  
A SL WD ACM



81-23578-00   
0514.14  
78x100  
A LD MVQ



1,1 XW7 (109N) 36 kW (49 PS) 205 02/83-07/87

02-23307-01  
0197.74



02-23775-06  
0197.74  
+0209.G8

02-27265-02  
0197.75  
+0209.A6

08-23542-01  
0197.76



61-23775-20  
0209.G8  
76 Ø  
1,2 mm  
16 mm



61-27265-10  
0209.A6  
76 Ø  
1,3 mm  
14 mm



71-23307-00  
0249.39





12-25837-01  
0956.22 (8x)



70-25837-00  
0956.22







71-25149-10   
0348.54







71-23308-20   
0349.C4

8x



71-26243-10    
1710.41  
 10/85





71-21274-20    
1710.09  
 11/85→



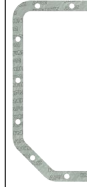

71-23542-30  
0304.46



81-21798-30   
0236.14  
35x50  
A SL WD ACM



81-23578-00   
0514.14  
78x100  
A LD MVQ



1,2 F1 47 kW (64 PS) 205 01/87-12/90

71-12902-00  
0249.53





12-25837-01  
0956.22 (8x)



70-25837-00  
0956.22



71-80769-00   
0349.E2































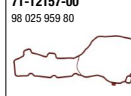
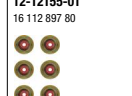

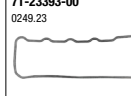

71-21718-00  
0304.32

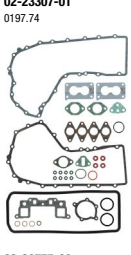

PEUGEOT

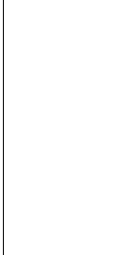
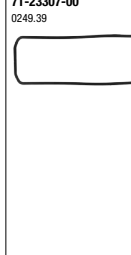
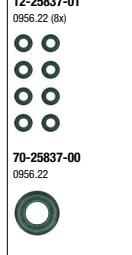

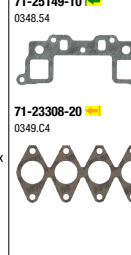
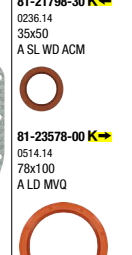









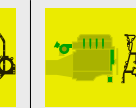

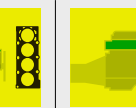
Ltr.	Motor	Power	Year	Ref. No.	Image 1	Image 2	Image 3	Image 4	Image 5	Image 6	Image 7	Image 8	Image 9	Image 10	Image 11	Image 12
1.2	HMH (EB2FAD) HMJ (EB2FAM) HMM (EB2FAD) HMR (EB2FA)	50-61 kW (68-83 PS)	2008 208 301	06/15												
						02-10002-04	08-10155-01		61-10002-00 98 107 491 80 76,3 Ø 0,7 mm MLS	14-10026-01 1608378180	15-11183-01	12-12155-01 16 112 897 80	11-11551-01 16 087 337 80	70-31414-10 	81-41219-00 16 140 859 80 61x75 A SL RD PTFE (Polytetrafluorethylen)/ACM (Polyacryl-Kautschuk)	
													71-11552-00 96 880 312 80		81-10461-00 16 111 874 80	
1.2	HMP (EB2FB) HMT (EB2D) HMX (EB2) HMY (EB2M) HMZ (EB2) HMZ (EB2F)	50-66 kW (68-90 PS)	108 2008 208 301 308	03/12					61-37745-00 96 761 486 80 76,3 Ø 0,7 mm MLS	14-10026-01 1608378180	15-11549-01 96 778 553 80	12-12155-01 16 112 897 80	11-11551-01 16 087 337 80	70-31414-10 	81-41219-00 16 140 859 80 61x75 A SL RD PTFE (Polytetrafluorethylen)/ACM (Polyacryl-Kautschuk)	
						02-37745-01	08-10461-01						71-11552-00 96 880 312 80		81-10461-00 16 111 874 80	
1.2	HNJ (EB2ADTXM) HNK (EB2ADT) HNL (EB2ADTSM) HNM (EB2ADTM) HNN (EB2ADTX) HNP (EB2ADT) HNR (EB2ADTXM) HNS (EB2ADTS) HNT (EB2ADTS)	74-114 kW (101-155 PS)	PARTNER HDI RIFTER RIFTER HDI 2008 208 3008 308 408 5008 508	01/13					61-10813-00 76 Ø MLS	14-10026-01 1608378180	70-31414-10 71-18240-00	12-12155-01 16 112 897 80	71-12156-00 98 039 185 80	70-31414-10 	81-41219-00 16 140 859 80 61x75 A SL RD PTFE (Polytetrafluorethylen)/ACM (Polyacryl-Kautschuk)	
						02-10813-02	08-10157-01						71-18242-00 		81-10461-00 16 111 874 80	

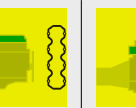
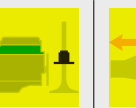
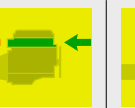
PEUGEOT

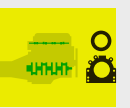









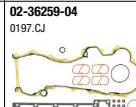
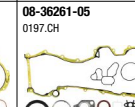

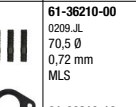
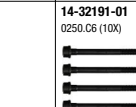
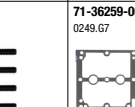
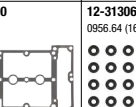
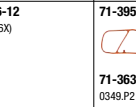
<p>Ltr. </p> <p>1.2 HNV (EB2DTM) HNW (EB2DTSM) HNX (EB2DTS) HNY (EB2DTS) HNZ (EB2DT)</p> <p>81-96 kW (110-131 PS)</p> <p>PARTNER TEPEE PARTNER THP 2008 208 3008 308 5008</p> <p>01/13 </p>											
<p>1.2 HNZ (EB2DT)</p> <p>81 kW (110 PS)</p> <p>PARTNER TEPEE 2008 208 308</p> <p>01/13</p>											
<p>1.2 XLD</p> <p>29 kW (39 PS)</p> <p>204 D</p> <p>05/68-05/73</p>											
<p>1.2 XZ5 (129)</p> <p>42 kW (57 PS)</p> <p>104</p> <p>08/79-06/83</p>	 <p>02-23307-01 0197.74</p> <p>02-23775-06 0197.74 +0209.68</p>	 <p>08-23542-01 0197.76</p>		 <p>61-23775-20 0209.68 76 Ø 1.2 mm 16 mm</p>		 <p>71-23307-00 0249.39</p>	 <p>12-25837-01 0956.22 (8x)</p> <p>70-25837-00 0956.22</p>	 <p>71-25149-10  0348.54</p> <p>71-23308-20  0349.C4</p> <p>8x</p>	 <p>71-23542-30 0304.46</p>	 <p>81-21798-30  0235.14 35x50 A SL WD ACM</p> <p>81-23578-00  0514.14 78x100 A LD MVQ</p>	

PEUGEOT





Ltr.  1,3 FHY (F13DTE6) 59 kW (80 PS) BIPPER HDI BIPPER TEPEE HDI 80 12/15 

											
	02-36259-04 0197.CJ	08-36261-05 0197.CH		61-36210-00 0209.JL 70,5 Ø 0,72 mm MLS  61-36210-10 0209.JC 70,5 Ø 0,82 mm MLS  61-36210-20 0209.JE 70,5 Ø 0,92 mm MLS	14-32191-01 0250.C6 (10X)	71-36259-00 0249.G7	12-31306-12 0956.64 (16X)	71-39538-00  4x  71-36322-00  0349.P2	70-31306-00 0956.64 16x	70-31414-10 	81-36233-00  0321.A1 40x52 AB SL RD FPM/ACM  81-36232-00  0127.55 78x100 A SL LD PTFE

1,3 FHZ (F13DTE5) 55 kW (75 PS) BIPPER HDI BIPPER TEPEE HDI 10/10

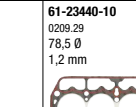
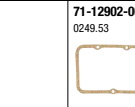
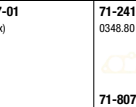
											
	02-36259-04 0197.CJ	08-36261-05 0197.CH	04-10324-02 	61-36210-00 0209.JL 70,5 Ø 0,72 mm MLS  61-36210-10 0209.JC 70,5 Ø 0,82 mm MLS  61-36210-20 0209.JE 70,5 Ø 0,92 mm MLS	14-32191-01 0250.C6 (10X)	71-36259-00 0249.G7	12-31306-12 0956.64 (16X)	71-39538-00  4x  71-36322-00  0349.P2	70-31306-00 0956.64 16x	70-31414-10 	81-36233-00  0321.A1 40x52 AB SL RD FPM/ACM  81-36232-00  0127.55 78x100 A SL LD PTFE































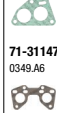

1,3 G1A 47 kW (62-64 PS) 205 309 02/84-07/92

										
				61-23440-10 0209.29 78,5 Ø 1,2 mm		71-12902-00 0249.53	12-25837-01 0956.22 (8x)	71-24161-00  8x 0348.80	71-80769-00  0349.E2	71-21718-00 0304.32















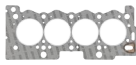





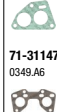



PEUGEOT







Ltr.  1,3 TU2J2 72 kW (98 PS) 106 10/93-04/96 

										
	<p><b>02-31146-01</b> </p> <p>0197.H8</p> 	<p><b>08-33674-01</b> </p> 			<p><b>14-32075-01</b></p> <p>0204.83 (10x)</p> 	<p><b>71-31146-00</b></p> <p>0249.54</p> 	<p><b>12-26058-02</b></p> <p>0956.19 (8x)</p>  <p><b>70-26058-00</b></p> <p>0956.19</p> 	<p><b>71-38817-00</b> </p> <p>0349.A6</p>  <p><b>71-31147-00</b> </p> <p>0349.A6</p> 	<p><b>71-33674-00</b> </p> 	<p><b>81-31863-00</b> </p> <p>0514.38</p> <p>42x66</p> <p>A SL RD FPM</p>  <p><b>81-23708-40</b> </p> <p>0514.74</p> <p>85x105</p> <p>A SL LD FPM</p>  <p><b>81-23708-50</b> </p> <p>0514.74</p> <p>85x105</p> <p>A SL LD FPM</p>  <p><b>81-26244-10</b> </p> <p>0236.21</p> <p>36x50</p> <p>A RD ACM</p> 

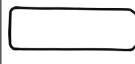





















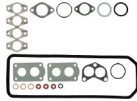
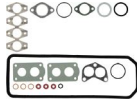
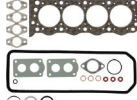

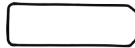







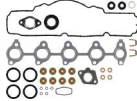
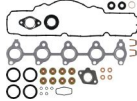





1,3 TU24 74 kW (101 PS) 205 10/87-10/90

	<p><b>02-31146-01</b> </p> <p>0197.H8</p> 	<p><b>08-33674-01</b> </p> 	<p><b>61-33715-00</b></p> <p>0209.CJ</p> <p>76 Ø</p> <p>1,3 mm</p>	<p><b>61-33715-10</b></p> <p>0209.CK</p> <p>76 Ø</p> <p>1,5 mm</p> 	<p><b>14-32075-01</b></p> <p>0204.83 (10x)</p> 	<p><b>71-31146-00</b></p> <p>0249.54</p> 	<p><b>12-26058-02</b></p> <p>0956.19 (8x)</p>  <p><b>70-26058-00</b></p> <p>0956.19</p> 	<p><b>71-38817-00</b> </p> <p>0349.A6</p>  <p><b>71-31147-00</b> </p> <p>0349.A6</p>  <p><b>71-31862-00</b> </p> <p>1709.10</p> 	<p><b>71-33674-00</b> </p> 	<p><b>81-31863-00</b> </p> <p>0514.38</p> <p>42x66</p> <p>A SL RD FPM</p>  <p><b>81-23708-50</b> </p> <p>0514.74</p> <p>85x105</p> <p>A SL LD FPM</p>  <p><b>81-26244-10</b> </p> <p>0236.21</p> <p>36x50</p> <p>A RD ACM</p> 
--	--	--	--	---	--	--	---	--	---	--





















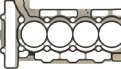



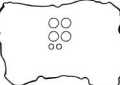
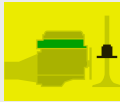

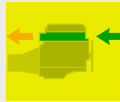











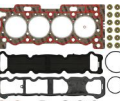

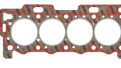
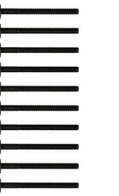











1,3 XL3 XL3S 48-55 kW (65-75 PS) 304 10/69-07/76

						<p><b>71-20601-00</b></p> <p>0249.21</p> 		<p><b>71-24251-20</b> </p> <p>0349.23</p>  <p><b>40-00996-00</b> </p> <p>1710.11</p> 	<p><b>71-12951-00</b></p> <p>0304.09</p> 	
--	--	--	--	--	--	--	--	---	--	--



PEUGEOT

<p>Ltr.  1,3 XL4D 33 kW (45 PS) 204 D 01/73-10/77</p>											
<p>1,3 XL5 XL5 (118) XL5S 44-55 kW (60-75 PS) 304 305 09/70-08/86</p>		<p>02-20601-01 0197.92</p>  <p>02-23785-05 0197.92 +0209.G7</p> 			<p>61-23785-40 0209.B3 80,5 Ø 1,3 mm</p> 	<p>14-32081-01 0204.36 (10x)</p>	<p>71-20601-00 0249.21</p> 	<p>12-25837-01 0956.22 (6x)</p>  <p>71-24251-20 0349.Z3</p>  <p>40-00996-00 1710.11</p>  <p>70-25837-00 0956.22</p> 	<p>71-12951-00 0304.09</p> 	<p>81-21649-00 K↔ 2074.07 40x49,6 A OD MVQ</p>  <p>81-21651-00 K↔ 2109.06 60,5x78 A RD MVQ</p> 	
<p>1,4 DV4TD (8HX) DV4TD (8HZ) 50-52 kW (68-70 PS) 1007 HDI 206 HDI 206 SW HDI 207 HDI 307 HDI 09/01</p>		<p>02-35542-01</p> 	<p>08-36869-01</p> 	<p>04-10081-01 03</p> 	<p>61-35430-00 0209.AC 75 Ø 1,25 mm MLS</p> <p>2</p> <p>61-35430-10 0209.AE 75 Ø 1,3 mm MLS</p> <p>3</p> <p>61-35430-20 0209.AF 75 Ø 1,35 mm MLS</p> <p>1</p> <p>61-35430-30 0209.AG 75 Ø 1,4 mm MLS</p> <p>4</p> <p>61-35430-40 0209.AH 75 Ø 1,45 mm MLS</p> <p>5</p> 	<p>14-32206-01 0204.A2 (10x)</p> 	<p>15-35542-01 0249.F8 +0348.T8 (4x) +0348.S8 (2x)</p>  <p>71-35542-00 0249.F8</p> 	<p>12-35548-01 0956.50 (6x)</p>  <p>71-35487-00 0349.J8</p>  <p>70-35548-00 0956.50</p> 	<p>40-76246-00 4x 0348.T8</p>  <p>71-35487-00 0349.J8</p>  <p>8x</p>	<p>70-31414-10</p> 	<p>81-35554-00 K↔ 0127.42 40x55 A SL RD PTFE ACM</p>  <p>81-35553-00 K↔ 0127.43 85x105 A SL LD PTFE ACM</p>  <p>81-35552-00 N 0807.30 27x47 A SL RD PTFE ACM</p> 

PEUGEOT

<p>Ltr.  </p> <p>1,4 EP3 EP3C 8FN (EP3C) 8FP (EP3C) 8FR (EP3) 8FR (EP3C) 8FS (EP3)</p> <p>70-72 kW (95-98 PS)</p> <p>207 16V 208 308 16V</p> <p>06/07-12/19</p>		 <p>02-38005-01</p>  <p>02-38005-02</p>  <p>02-38005-03</p> 			 <p>61-38005-00 0209.EW 78 Ø 0,9 mm MLS</p> <p>61-38005-10  78 Ø 1,2 mm MLS</p> 	 <p>14-32347-01 0204.C1</p> 	 <p>15-37633-01 0249.F4</p> 	 <p>12-37621-01 0956.60</p>  <p>70-37621-00</p> 	 <p>11-37632-01  0348.T4</p>  <p>16x 71-41213-00  1723.CH</p> 	 <p>70-31414-10</p> 	 <p>81-41219-00  16 140 859 80 61x75 A SL RD PTFE (Polytetrafluorethylen)/ACM (Polyacryl-Kautschuk)</p>  <p>81-38532-00  0514.A2 85x105 A SL LD PTFE (Polytetrafluorethylen)/ACM (Polyacryl-Kautschuk)</p> 
<p>1,4 ET3J4 (KFU)</p> <p>65 kW (88 PS)</p> <p>1007 16V 206 SW 16V 206 16V 207 307 SW 16V 307 16V</p> <p>10/03</p>		<p>02-36505-01</p> 	<p>08-38533-01</p> 		<p>61-36505-00 0209.FL 76 Ø 1,4 mm</p> 	<p>14-32343-01 0204.A5 (10x)</p> 	<p>71-36953-00  0249.C5</p>  <p>71-36954-00  0249.C4</p> 	<p>12-38538-01 0956.52 (16x)</p>  <p>70-38538-00 0956.52</p> 	<p>11-36956-01  0348.S1</p>  <p>16x 71-35067-00  0349.L3</p>  <p>71-39639-00  1709.29</p> 	<p>70-31414-10</p> 	<p>81-38533-00  0514.A3 42x66 A SL RD PTFE (Polytetrafluorethylen)/ACM (Polyacryl-Kautschuk)</p>  <p>81-23708-50  0514.74 85x105 A SL LD FPM</p>  <p>81-39633-00  0807.32 36x50 A SL RD PTFE ACM</p>  <p>81-39634-00  0807.33 24x50 A SL RD PTFE (Polytetrafluorethylen)/ACM (Polyacryl-Kautschuk)</p> 

**PEUGEOT**

Ltr.  1,4 KFT (TU3A) 54 kW (73 PS) 207  04/06-10/13  1

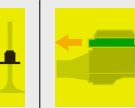
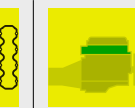
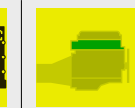

02-31146-03







02-33715-02





08-38532-02











61-33715-00  
0209.CJ  
76 0  
1,3 mm

61-33715-10  
0209.CK  
76 0  
1,5 mm



14-32075-01  
0204.83 (10x)



71-31146-00  
0249.54



12-26058-02  
0956.19 (8x)

























71-35247-00  4x  
0342.E0



71-35068-00   
0349.K1



71-42093-00    
1709.33



70-31414-10



81-38533-00   
0514.A3  
42x66  
A SL RD PTFE  
(Polytetrafluorethylen)/ACM  
(Polyacryl-Kautschuk)



81-38532-00   
0514.A2  
85x105  
A SL LD PTFE  
(Polytetrafluorethylen)/ACM  
(Polyacryl-Kautschuk)



1,4 KFT (TU3AE5) 54 kW (73 PS) BIPPER BIPPER TEPPE 206 207 04/06

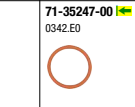
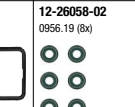
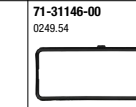
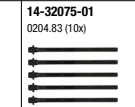
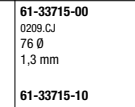
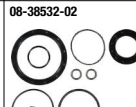

02-31146-03







02-33715-02





08-38532-02



















61-33715-00  
0209.CJ  
76 0  
1,3 mm

61-33715-10  
0209.CK  
76 0  
1,5 mm



14-32075-01  
0204.83 (10x)



71-31146-00  
0249.54



12-26058-02  
0956.19 (8x)

















71-35247-00  4x  
0342.E0



71-35068-00   
0349.K1



71-42093-00    
1709.33



70-31414-10



81-38533-00   
0514.A3  
42x66  
A SL RD PTFE  
(Polytetrafluorethylen)/ACM  
(Polyacryl-Kautschuk)



81-38532-00   
0514.A2  
85x105  
A SL LD PTFE  
(Polytetrafluorethylen)/ACM  
(Polyacryl-Kautschuk)























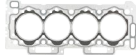





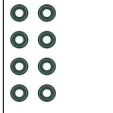















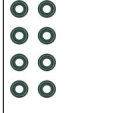

81-39633-00 **N**  
0807.32  
36x50  
A SL RD PTFE ACM



















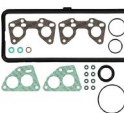











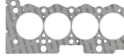



















PEUGEOT

Ltr.	Icon	Power	Model	Year	Image 1	Image 2	Image 3	Image 4	Image 5	Image 6	Image 7	Image 8	Image 9	Image 10	Image 11	Image 12
1,4		KFW (TU3A) TU3JP (KFW) TU3JP (KFX)	48-60 kW (65-82 PS) HOGGAR PARTNER PARTNER COMBISPACE 1007 106 205 206 206 SW 207 306 307	07/88												
					<p><b>02-31146-01</b> </p> <p>0197.H8</p> <p><b>02-31200-01</b> </p> <p>0197.H8 +0209.CJ</p>	<p><b>08-33674-01</b> </p>		<p><b>61-33715-00</b></p> <p>0209.CJ 76 Ø 1,3 mm</p> <p><b>61-33715-10</b></p> <p>0209.CK 76 Ø 1,5 mm</p>	<p><b>14-32075-01</b></p> <p>0204.83 (10x)</p>	<p><b>71-31146-00</b></p> <p>0249.54</p>	<p><b>12-26058-02</b></p> <p>0956.19 (8x)</p> <p><b>70-26058-00</b></p> <p>0956.19</p>	<p><b>71-35247-00</b> </p> <p>0342.E0</p> <p><b>71-31147-00</b> </p> <p>0349.A6</p> <p>4x</p> <p><b>71-33774-00</b> </p> <p>0349.J6</p> <p><b>71-35068-00</b> </p> <p>0349.K1</p>	<p><b>71-33674-00</b> </p>	<p><b>81-31863-00</b> </p> <p>0514.38 42x66 A SL RD FPM</p> <p><b>81-23708-50</b> </p> <p>0514.74 85x105 A SL LD FPM</p> <p><b>81-26244-10</b> </p> <p>0236.21 36x50 A RD ACM</p>		
1,4		KFZ (TU3FJ2Z)	69 kW (94 PS) 106	09/91-11/94		<p><b>02-28910-01</b></p> <p>0197.J0 +0209.D6</p>		<p><b>61-28910-00</b></p> <p>0209.D6 77 Ø 1,2 mm</p> <p><b>61-28910-10</b></p> <p>0209.C1 77 Ø 1,4 mm</p>	<p><b>14-32075-01</b></p> <p>0204.83 (10x)</p>	<p><b>71-31146-00</b></p> <p>0249.54</p>	<p><b>12-26058-02</b></p> <p>0956.19 (8x)</p> <p><b>70-26058-00</b></p> <p>0956.19</p>	<p><b>71-31147-00</b> </p> <p>0349.A6</p> <p>2x</p>	<p><b>70-31414-10</b></p>	<p><b>81-31863-00</b> </p> <p>0514.38 42x66 A SL RD FPM</p> <p><b>81-23708-50</b> </p> <p>0514.74 85x105 A SL LD FPM</p> <p><b>81-26244-10</b> </p> <p>0236.21 36x50 A RD ACM</p>		

PEUGEOT

<p>Ltr.  1,4 TUD3 (K9Y) 37 kW (50 PS) 106 106 D 08/91-04/96 </p>		 <p><b>02-31117-01</b> 0197.K3</p>  	 <p><b>08-31859-01</b> </p> 		 <p><b>61-31190-00</b> 0209.E9 76 Ø 1,8 mm</p> <p><b>61-31190-10</b> 0209.N4 76 Ø 1,95 mm MLS</p> 	 <p><b>14-32076-01</b> 0204.84 (10x)</p> 	 <p><b>71-31117-00</b> 0249.76</p> 	 <p><b>12-26058-02</b> 0956.19 (8x)</p>  <p><b>70-26058-00</b> 0956.19</p> 	 <p><b>71-31119-00</b>  0349.E4</p> 	 <p><b>71-33674-00</b> </p> 	 <p><b>81-31863-00</b>  0514.38 42x66 A SL RD FPM</p>  <p><b>81-23708-40</b>  85x105 A SL LD FPM</p>  <p><b>81-23708-50</b>  0514.74 85x105 A SL LD FPM</p>  <p><b>81-34403-00</b> <b>N</b> 0236.44 36x50 A SL FPM</p> 
<p>1,4 TU3A (KFV) 54-60 kW (73-82 PS) BIPPER BIPPER TEPEE 1007 206 206 SW 207 207 LPG 07/02</p>					<p><b>61-33715-00</b> 0209.CJ 76 Ø 1,3 mm</p> <p><b>61-33715-10</b> 0209.CK 76 Ø 1,5 mm</p> 	<p><b>14-32075-01</b> 0204.83 (10x)</p> 	<p><b>71-31146-00</b> 0249.54</p> 	<p><b>12-26058-02</b> 0956.19 (8x)</p>  <p><b>70-26058-00</b> 0956.19</p> 	<p><b>71-35247-00</b>  0342.E0</p>  <p><b>71-35068-00</b>  0349.K1</p> 	<p><b>70-31414-10</b></p> 	<p><b>81-38533-00</b>  0514.A3 42x66 A SL RD PTFE (Polytetrafluorethylen)/ACM (Polyacryl-Kautschuk)</p>  <p><b>81-38532-00</b>  0514.A2 85x105 A SL LD PTFE (Polytetrafluorethylen)/ACM (Polyacryl-Kautschuk)</p> 

PEUGEOT

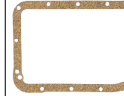
<p>Ltr.  1,4</p> <p>TU3A (K1D) TU3CP (KAY) TU3M (KDZ) TU3MC (KDX) TU3S (K2B) TU32</p> <p>44-62 kW (60-84 PS)</p> <p>PARTNER 106 205 306 309 405</p> <p>06/87-12/15</p> <p> 1</p>		 <p><b>02-31146-01</b>  0197.H8</p>  <p><b>02-31146-02</b>  0197.J0</p>  <p><b>02-31200-01</b>  0197.H8 +0209.CJ</p>  <p><b>02-33710-01</b>  0197.J0 +0209.A9</p> 	 <p><b>08-31859-01</b> </p>  <p><b>08-33674-01</b> </p> 		 <p><b>61-33710-00</b> 0209.A9 76,3 Ø 1,2 mm</p> <p><b>61-33710-10</b> 0209.92 76 Ø 1,5 mm</p>  <p><b>61-33715-00</b> 0209.CJ 76 Ø 1,3 mm</p> <p><b>61-33715-10</b> 0209.CK 76 Ø 1,5 mm</p> 	 <p><b>14-32075-01</b> 0204.83 (10x)</p> 	 <p><b>71-31146-00</b> 0249.54</p> 	 <p><b>12-26058-02</b> 0956.19 (8x)</p>  <p><b>70-26058-00</b> 0956.19</p> 	 <p><b>71-35247-00</b>  4x 0342.E0</p>  <p><b>71-31147-00</b>  2x 0349.A6</p>  <p><b>71-31862-00</b>   16 1709.10</p> 	 <p><b>70-31414-10</b></p>  <p><b>71-33674-00</b> </p> 	 <p><b>81-31863-00</b>  0514.38 42x66 A SL RD FPM</p>  <p><b>81-23708-50</b>  0514.74 85x105 A SL LD FPM</p>  <p><b>81-26244-10</b>  0236.21 36x50 A RD ACM</p> 
<p>1,4 XL4D</p> <p>33 kW (45 PS)</p> <p>204 D 304 D</p> <p>09/73-10/79</p>							<p><b>71-23393-00</b> 0249.23</p> 	<p><b>40-00996-00</b>   16 1710.11</p> 	<p><b>71-12951-00</b> 0304.09</p> 		

PEUGEOT

Ltr.	Icon	Power	Capacity	Code	Icon	Part No.	Dimensions	Icon	Part No.	Dimensions	Icon	Part No.	Dimensions	Icon	Part No.	Dimensions	Icon	Part No.	Dimensions																					
1,4		XY6B (150) XY7 (150D) XY7 (150G) XY8 (150B) XY8 (150H)	44-59 kW (60-80 PS)	104 205 405		08/79-05/89			<b>02-23307-02</b> 0197.75			<b>08-23542-01</b> 0197.76			<b>61-23775-20</b> 0209.G8 76 Ø 1,2 mm 16 mm			<b>71-23307-00</b> 0249.39			<b>12-25837-01</b> 0956.22 (8x)			<b>71-25149-10</b> 0348.54			<b>71-23542-30</b> 0304.46			<b>81-21798-30</b> 0236.14 35x50 A SL WD ACM			<b>81-23578-00</b> 0514.14 78x100 A LD MVQ							
										<b>02-23775-05</b> 0197.19																														
											<b>02-27265-02</b> 0197.75 +0209.A6																													
1,4	Y2/K		63 kW (86 PS)	205		06/87-12/89									<b>61-23440-10</b> 0209.29 78,5 Ø 1,2 mm				<b>71-12902-00</b> 0249.53			<b>12-25837-01</b> 0956.22 (8x)			<b>71-24161-00</b> 0348.80			<b>71-21718-00</b> 0304.32												

















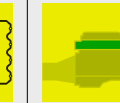
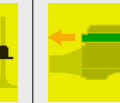
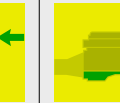
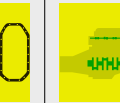











PEUGEOT











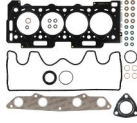

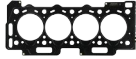

Ltr.	Engine	Power	Model	Year	Image 1	Image 2	Image 3	Image 4	Image 5	Image 6	Image 7	Image 8	Image 9	Image 10	Image 11	Image 12
1,4	8HP (DV4C) 8HR (DV4C)	50 kW (68 PS)	2008 HDI 206 HDI 207 HDI 208 HDI	02/06												
								<p><b>04-10340-01</b> </p> <p>0209.HH 74,7 Ø 1,25 mm MLS</p> <p><b>61-37945-00</b> 0209.HH 74,7 Ø 1,25 mm MLS</p> <p><b>61-37945-10</b> 0209.HJ 74,7 Ø 1,3 mm MLS</p> <p><b>61-37945-20</b> 0209.HK 74,7 Ø 1,35 mm MLS</p> <p><b>61-37945-30</b> 0209.HL 74,7 Ø 1,4 mm MLS</p> <p><b>61-37945-40</b> 0209.HN 74,7 Ø 1,45 mm MLS</p>	<p><b>14-32336-01</b> 0205.57 (10x)</p>	<p><b>71-40903-00</b> 0249.G2</p>	<p><b>12-35548-01</b> 0956.50 (8x)</p> <p><b>70-35548-00</b> 0956.50</p> <p>8x</p>	<p><b>71-39037-00</b> </p> <p>98 106 973 80</p>	<p><b>70-31414-10</b></p>	<p><b>81-35554-00</b> </p> <p>0127.42 40x55 A SL RD PTFE ACM</p> <p><b>81-35553-00</b> </p> <p>0127.43 85x105 A SL LD PTFE ACM</p> <p><b>81-35552-00</b> <b>N</b></p> <p>0807.30 27x47 A SL RD PTFE ACM</p>		
1,4	8HS (DV4TED) 8HT (DV4TD)	40-50 kW (54-68 PS)	BIPPER HDI BIPPER TEEPEE HDI 107 HDI	06/05				<p><b>04-10081-01</b> </p> <p>0209.AC 75 Ø 1,25 mm MLS</p> <p><b>61-35430-10</b> 0209.AE 75 Ø 1,3 mm MLS</p> <p><b>61-35430-20</b> 0209.AF 75 Ø 1,35 mm MLS</p> <p><b>61-35430-30</b> 0209.AG 75 Ø 1,4 mm MLS</p> <p><b>61-35430-40</b> 0209.AH 75 Ø 1,45 mm MLS</p>	<p><b>14-32206-01</b> 0204.A2 (10x)</p>	<p><b>15-35542-01</b> 0249.F8 +0348.T8 (4x) +0348.S8 (2x)</p> <p><b>71-35542-00</b> 0249.F8</p>	<p><b>12-35548-01</b> 0956.50 (8x)</p> <p><b>70-35548-00</b> 0956.50</p> <p>8x</p>	<p><b>40-76246-00</b> </p> <p>0348.T8</p> <p><b>71-35487-00</b> </p> <p>0349.J8</p>	<p><b>70-31414-10</b></p>	<p><b>81-35554-00</b> </p> <p>0127.42 40x55 A SL RD PTFE ACM</p> <p><b>81-35553-00</b> </p> <p>0127.43 85x105 A SL LD PTFE ACM</p> <p><b>81-35552-00</b> <b>N</b></p> <p>0807.30 27x47 A SL RD PTFE ACM</p>		

PEUGEOT





Ltr.  1,5 TUD5 (VJX) 40-43 kW (54-58 PS) 106 D 06/94-07/04  1

										
	<p><b>02-33645-01</b> 0197.V1 +0209.T8</p> 	<p><b>08-33659-01</b> 0197.V0</p> 		<p><b>61-33645-00</b> 0209.T8 78,2 Ø 1,6 mm MLS</p> 	<p><b>14-32163-01</b> 0204.85 (10x)</p> 	<p><b>71-33661-00</b> 0249.93</p> 	<p><b>12-26058-02</b> 0956.19 (8x)</p>  <p><b>70-26058-00</b> 0956.19</p> 	<p><b>71-31119-00</b>  0349.E4</p>  <p><b>71-31118-00</b>  1710.58</p>  <p>8x</p>	<p><b>70-31414-10</b></p> 	<p><b>81-31863-00 K</b>  0514.38 42x66 A SL RD FPM</p>  <p><b>81-23708-40 K</b>  85x105 A SL LD FPM</p>  <p><b>81-23708-50 K</b>  0514.74 85x105 A SL LD FPM</p>  <p><b>81-34403-00 N</b> 0236.44 36x50 A SL FPM</p> 























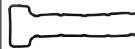





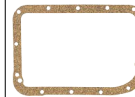





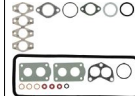
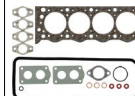

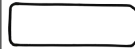

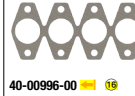

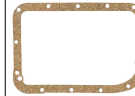

















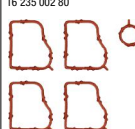

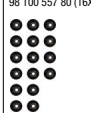

1,5 VJZ (TUD5) 42-43 kW (57-58 PS) 106 D 06/94-07/04

	<p><b>02-33645-01</b> 0197.V1 +0209.T8</p> 	<p><b>08-33659-01</b> 0197.V0</p> 		<p><b>61-33645-00</b> 0209.T8 78,2 Ø 1,6 mm MLS</p> 	<p><b>14-32163-01</b> 0204.85 (10x)</p> 	<p><b>71-33661-00</b> 0249.93</p> 	<p><b>12-26058-02</b> 0956.19 (8x)</p>  <p><b>70-26058-00</b> 0956.19</p> 	<p><b>71-31119-00</b>  0349.E4</p>  <p>8x</p>	<p><b>70-31414-10</b></p> 	<p><b>81-31863-00 K</b>  0514.38 42x66 A SL RD FPM</p>  <p><b>81-23708-50 K</b>  0514.74 85x105 A SL LD FPM</p>  <p><b>81-26244-10 N</b> 0236.21 36x50 A RD ACM</p> 
--	--	--	--	---	---	---	--	---	---	---















































1,5 XB5 39-61 kW (53-83 PS) J7 08/68

						<p><b>71-19231-00</b> 0249.14</p> 		<p><b>71-17538-10</b>  0349.03</p>  <p>4x</p>	<p><b>71-12921-20</b> 0304.44</p> 	
--	--	--	--	--	--	---	--	---	---	--

PEUGEOT

















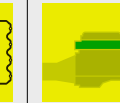
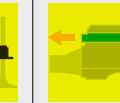
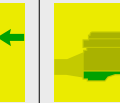
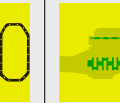





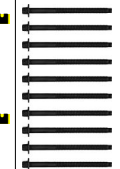

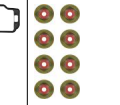

<p>Ltr. </p> <p>1,5 XID (149)</p> <p>36 kW (49 PS)</p> <p>304 305 D</p> <p>10/69-09/82 </p>	 <p>01-25352-02</p>	 <p>02-25352-02</p>			 <p>61-24460-40 0203.98 82 Ø 1,7 mm </p> <p>61-24460-50 0203.99 82 Ø 1,75 mm </p> 	 <p>14-32081-01 0204.36 (10x)</p>	 <p>71-25352-00 0249.41</p> 		 <p>71-25371-10  4x 0349.82</p> 	 <p>71-12951-00 0304.09</p> 	 <p>81-17857-40  K↔ 0514.24 45x62 A SL LD FPM</p>  <p>81-21651-00  K↔ 2109.06 60,5x78 A RD MVQ</p> 
<p>1,5 XR5 (142) XR5A (142) XR5S (117)</p> <p>50-65 kW (68-88 PS)</p> <p>305</p> <p>11/79-07/90</p>	<p>02-20601-01 0197.92</p>  <p>02-23785-05 0197.92 +0209.67</p> 	<p>61-23785-40 0209.83 80,5 Ø 1,3 mm</p> 			<p>14-32081-01 0204.36 (10x)</p>	<p>71-20601-00 0249.21</p> 	<p>12-25837-01 0956.22 (8x)</p> 	<p>71-24251-20  8x 0349.23</p>  <p>40-00996-00  06 1710.11</p> 	<p>71-12951-00 0304.09</p> 	<p>81-21649-00  K↔ 2074.07 40x49,6 A OD MVQ</p>  <p>81-21651-00  K↔ 2109.06 60,5x78 A RD MVQ</p> 	
<p>1,5 YHR (DV5RUCd) YHS (DV5RCE) YHT (DV5RCF) YHV (DV5RUC) YHX (DV5RC) YHZ (DV5RC)</p> <p>75-96 kW (102-131 PS)</p> <p>EXPERT HDI PARTNER HDI RIFTER HDI TRAVELLER HDI 2008 2008 HDI 120 2008 HDI 130 208 HDI 3008 HDI 308 308 HDI 5008 HDI 508 HDI</p> <p>06/17 </p>	<p>02-10750-02</p>  	<p>08-10147-01</p> 	<p>04-10380-01 </p> 	<p>61-10750-00 98 244 936 80 76,3 Ø 1,25 mm MLS </p> <p>61-10750-10 98 244 937 80 76,3 Ø 1,3 mm MLS </p> <p>61-10750-20 98 244 938 80 76,3 Ø 1,35 mm MLS </p> <p>61-10750-30 98 244 939 80 76,3 Ø 1,4 mm MLS </p> <p>61-10750-40 98 244 940 80 76,3 Ø 1,45 mm MLS </p> 	<p>14-32336-01 0205.57 (10x)</p> 	<p>15-11035-01 </p> <p>16 235 002 80</p>  <p>70-31414-10 </p> 	<p>12-17500-01 98 100 557 80 (16x)</p>  <p>70-17500-00 98 100 557 80</p> 	<p>71-17331-00 </p> <p>98 137 567 80</p>  <p>71-10654-00  16x 98 162 672 80</p> 	<p>70-31414-10</p> 	<p>81-10652-00  K↔ 98 209 610 80 38x55 A SL RD PTFE</p>  <p>81-38532-00  K↔ 0514.A2 85x105 A SL LD PTFE (Polytetrafluorethylen)/ACM (Polyacryl-Kautschuk)</p>  <p>81-10678-00  N 98 239 200 80 24,7x47 A SL RD PTFE</p> 	

PEUGEOT

<p>Ltr. </p>	<p>1,5 YHW (DV5RE) YHY (DV5RD)</p> <p>55-75 kW (75-102 PS)</p> <p>PARTNER HDI RIFTER HDI 2008 HDI 100 208 HDI 301 HDI 100 308 HDI</p> <p>04/18</p>											
<p>1,5</p>	<p>02-10750-02</p> 	<p>08-10147-01</p> 			<p>61-10750-00 98 244 936 80 76,3 Ø 1,25 mm MLS</p> <p>2 </p> <p>61-10750-10 98 244 937 80 76,3 Ø 1,3 mm MLS</p> <p>3 </p> <p>61-10750-20 98 244 938 80 76,3 Ø 1,35 mm MLS</p> <p>1 </p> <p>61-10750-30 98 244 939 80 76,3 Ø 1,4 mm MLS</p> <p>4 </p> <p>61-10750-40 98 244 940 80 76,3 Ø 1,45 mm MLS</p> <p>5 </p> 	<p>14-32336-01 0205.57 (10x)</p> 	<p>15-11035-01 </p> <p>16 235 002 80</p>  <p>70-31414-10 </p> 	<p>12-17500-01 98 100 557 80 (16x)</p>  <p>70-17500-00 98 100 557 80</p> 	<p>71-17331-00 </p> <p>98 137 567 80</p>  <p>71-10654-00 </p> <p>98 162 672 80</p> 	<p>70-31414-10</p> 	<p>81-10552-00 </p> <p>98 209 610 80 38x55 A SL RD PTFE</p>  <p>81-38532-00 </p> <p>0514.A2 85x105 A SL LD PTFE (Polytetrafluorethylen)/ACM (Polyacryl-Kautschuk)</p>  <p>81-10578-00 </p> <p>98 239 200 80 24,7x47 A SL RD PTFE</p> 	
<p>1,5 Y2/K</p>	<p>63 kW (86 PS)</p> <p>205 309</p>				<p>61-23440-10 0209.29 78,5 Ø 1,2 mm</p> 		<p>71-12902-00 0249.53</p> 	<p>12-25837-01 0956.22 (8x)</p>  <p>70-25837-00 0956.22</p> 	<p>71-24161-00 </p> <p>0348.80</p>  <p>71-80769-00 </p> <p>0349.E2</p> 	<p>71-21718-00 0304.32</p> 		



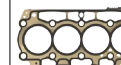















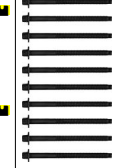

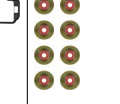

PEUGEOT

Ltr.  1,6 BHS (DV6FDU) 70 kW (95 PS) EXPERT HDI TRAVELLER HDI 95 04/16 **[NEW]**

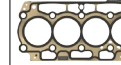

										
			04-10383-01 	61-10039-00 0209.JN 76 Ø 1,25 mm MLS	14-32336-01 0205.57 (10x)	71-40903-00 0249.G2	12-35548-01 0956.50 (8x)	71-39037-00  98 106 973 80	70-31414-10 	81-34454-10  16 089 406 80 40x55 A SL RD PTFE
				61-10039-10 0209.JP 76 Ø 1,3 mm MLS						
				61-10039-20 0209.JQ 76 Ø 1,35 mm MLS			70-35548-00 0956.50	8x		
				61-10039-30 0209.JR 76 Ø 1,4 mm MLS						
				61-10039-40 0209.JS 76 Ø 1,45 mm MLS						
										

1,6 BHV (DV6FDU) 55-88 kW (75-120 PS) EXPERT HDI 06/08 **[NEW]**  
 BHW (DV6FE)  
 BHX (DV6FC)  
 BHX (DV6FCU)  
 BHY (DV6FD)  
 BHZ (DV6FC)

EXPERT HDI 115  
 EXPERT HDI 95  
 PARTNER  
 PARTNER HDI  
 PARTNER HDI 100  
 PARTNER HDI 120  
 PARTNER HDI 75  
 PARTNER TEPEE HDI  
 RIFTER HDI  
 TRAVELLER HDI 115  
 TRAVELLER HDI 95  
 2008 HDI  
 2008 HDI 100  
 2008 HDI 120  
 2008 HDI 75  
 208 HDI  
 208 HDI 100  
 208 HDI 120  
 208 HDI 75  
 3008 HDI  
 3008 HDI 115  
 3008 HDI 120  
 301 HDI 100  
 308 HDI  
 308 HDI 100  
 308 HDI 115  
 308 HDI 120  
 5008  
 5008 HDI  
 5008 HDI 120  
 508 HDI  
 508 HDI 120

			04-10383-01 	61-10039-00 0209.JN 76 Ø 1,25 mm MLS	14-32336-01 0205.57 (10x)	71-40903-00 0249.G2	12-35548-01 0956.50 (8x)	71-39037-00  98 106 973 80	70-31414-10 	81-35554-00  0127.42 40x55 A SL RD PTFE ACM
				61-10039-10 0209.JP 76 Ø 1,3 mm MLS						
				61-10039-20 0209.JQ 76 Ø 1,35 mm MLS			70-35548-00 0956.50	8x		
				61-10039-30 0209.JR 76 Ø 1,4 mm MLS						
				61-10039-40 0209.JS 76 Ø 1,45 mm MLS						
										

PEUGEOT

Ltr.    1

1,6 DGX (EP6FADTXHPE) 133-265 kW (181-360 PS) 3008 01/18  
 DGY (EP6FADTXHPD) 308  
 5GB (EP6FADTXHPA) 408  
 5GB (EP6FADTXHPR) 5008  
 5GF (EP6FADTXD) 508  
 5GG (EP6FADTX) 508  
 5GQ (EP6FADTXHPD)

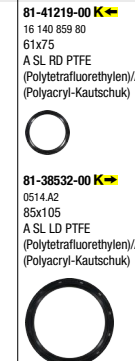
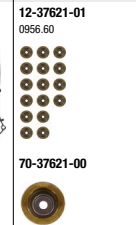
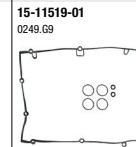
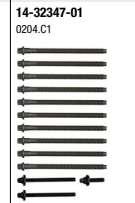
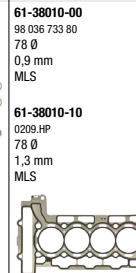
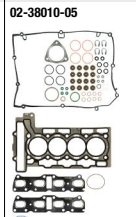
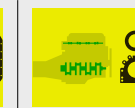
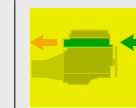



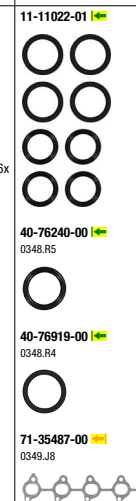
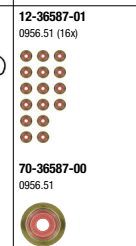
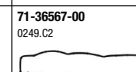
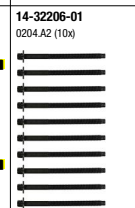
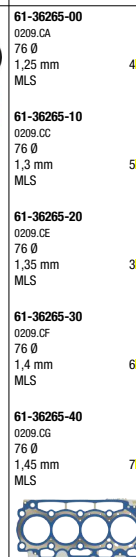
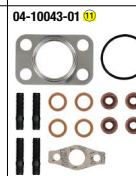
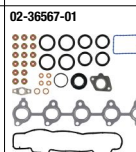







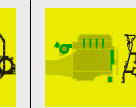

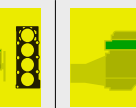

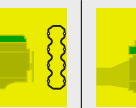
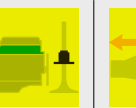
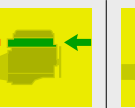

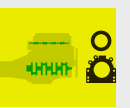
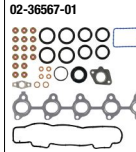

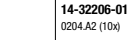

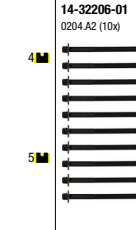
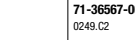
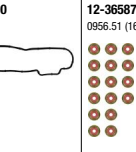

1,6 DV6ATED4 (9HX) 55-82 kW (75-111 PS) EXPRESS TD 11/03  
 DV6TED4 (9HY) PARTNER HDI  
 DV6TED4 (9HZ) PARTNER HDI 16V  
 9HT (DV6BUTED4) PARTNER TEPEE HDI  
 9HV (DV6TED4) PARTNER TEPEE HDI 16V  
 9HV (DV6TED4B) 1007 HDI  
 9HV (DV6TED4BU) 206 CC HDI FAP 110  
 9HX (DV6AUTED4) 206 HDI FAP 110  
 206 SW HDI FAP 110  
 207 CC HDI  
 207 HDI  
 3008 HDI  
 307 HDI  
 307 HDI 110 FAP  
 307 HDI 90  
 307 SW HDI 110 FAP  
 308 HDI  
 407 HDI  
 407 HDI 110 FAP  
 407 SW HDI 110 FAP  
 408 HDI  
 5008 HDI

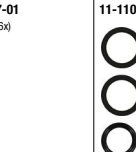
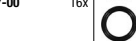











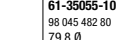
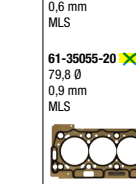

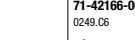
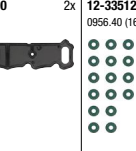
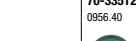
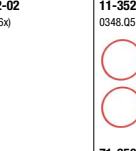
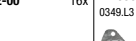
PEUGEOT

Ltr.  1,6 DV6BTE4 (9HT) 9HU (DV6UTED4) 55-66 kW (75-90 PS) EXPERT HDI 90 16V EXPERT TEPEE HDI 90 16V PARTNER HDI 01/07 

											
	02-36567-01 		04-10043-01 	61-36265-00 0209.CA 76 Ø 1,25 mm MLS 4  61-36265-10 0209.CC 76 Ø 1,3 mm MLS 5  61-36265-20 0209.CE 76 Ø 1,35 mm MLS 3  61-36265-30 0209.CF 76 Ø 1,4 mm MLS 6  61-36265-40 0209.CG 76 Ø 1,45 mm MLS 7 	14-32206-01 0204.A2 (10x) 	71-36567-00 0249.C2 	12-36587-01 0956.S1 (16x)  70-36587-00 0956.S1 	11-11022-01  40-76240-00  4x 0348.R5 40-76919-00  4x 0348.R4 71-35487-00  0349.J8	70-31414-10 	81-35554-00  K 0127.42 40x55 A SL RD PTFE ACM 81-35553-00  K 0127.43 85x105 A SL LD PTFE ACM 	

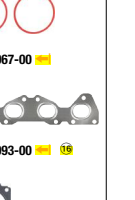
1,6 EC5F 85-90 kW (115-122 PS) PARTNER 16V RIFTER 2008 01/12  
NFJ (EC5F)  
NFP (EC5)  
NFP (EC5F)  
207  
208  
301  
308  
408

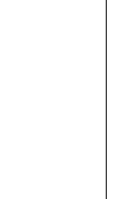















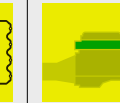
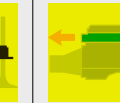
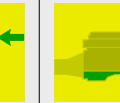
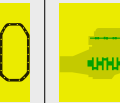



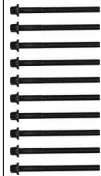



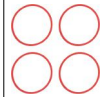

	02-35055-04 	08-38532-02 		61-35055-10 98 045 482 80 79,8 Ø 0,6 mm MLS 61-35055-20  X 79,8 Ø 0,9 mm MLS 	14-32139-04 0204.C4 (10X) 	71-42166-00 0249.C6 	12-33512-02 0956.40 (16x)  70-33512-00 0956.40 	11-35246-01  0348.O5 71-35067-00  0349.L3 71-42093-00  1709.33 	70-31414-10 	81-38533-00  K 0514.A3 42x66 A SL RD PTFE (Polytetrafluorethylen)/ACM (Polyacryl-Kautschuk) 81-38532-00  K 0514.A2 85x105 A SL LD PTFE (Polytetrafluorethylen)/ACM (Polyacryl-Kautschuk)  81-38531-00  N 0807.34 38x50 A SL RD PTFE (Polytetrafluorethylen)/ACM (Polyacryl-Kautschuk) 81-38657-00  N 0236.74 39x50 A SL RD PTFE (Polytetrafluorethylen)/ACM (Polyacryl-Kautschuk) 
--	--	--	--	--	---	---	--	---	--	--

PEUGEOT															
1,6	EGX (EP6FADTR) GCR (EP6FADTX) GFR (EP6FADTXD) GGR (EP6FADTX)	133-193 kW (181-263 PS)	308 508	01/18		<p><b>02-38010-05</b></p>	<p><b>08-10148-01</b></p>	<p><b>61-38010-00</b> 98 036 733 80 78 Ø 0,9 mm MLS</p> <p><b>61-38010-10</b> 0209.HP 78 Ø 1,3 mm MLS</p>	<p><b>14-32347-01</b> 0204.C1</p>	<p><b>15-11519-01</b> 0249.G9</p>	<p><b>12-37621-01</b> 0956.60</p> <p><b>70-37621-00</b></p>	<p><b>11-37616-01</b> </p> <p>0348.S9</p>	<p><b>70-31414-10</b></p>	<p><b>81-41219-00</b> </p> <p>16 140 859 80 61x75 A SL RD PTFE (Polytetrafluorethylen)/ACM (Polyacryl-Kautschuk)</p> <p><b>81-38532-00</b> </p> <p>0514.A2 85x105 A SL LD PTFE (Polytetrafluorethylen)/ACM (Polyacryl-Kautschuk)</p>	
1,6	EP6 5FS (EP6C) 5FS (EP6C M)	81-88 kW (110-120 PS)	PARTNER PARTNER TEPEE 2008 207 207 CC 16V 207 16V 208 3008 308 16V 408 5008 16V 508	02/07		<p><b>02-38005-01</b></p> <p><b>02-38005-02</b></p> <p><b>02-38005-03</b></p>	<p><b>61-38005-00</b> 0209.EW 78 Ø 0,9 mm MLS</p> <p><b>61-38005-10</b> </p> <p>78 Ø 1,2 mm MLS</p>	<p><b>14-32347-01</b> 0204.C1</p>	<p><b>15-37633-01</b> 0249.F4</p>	<p><b>12-37621-01</b> 0956.60</p> <p><b>70-37621-00</b></p>	<p><b>11-37632-01</b> </p> <p>0348.T4</p> <p><b>71-41213-00</b> </p> <p>1723.CH</p>	<p><b>70-31414-10</b></p>	<p><b>81-41219-00</b> </p> <p>16 140 859 80 61x75 A SL RD PTFE (Polytetrafluorethylen)/ACM (Polyacryl-Kautschuk)</p> <p><b>81-38532-00</b> </p> <p>0514.A2 85x105 A SL LD PTFE (Polytetrafluorethylen)/ACM (Polyacryl-Kautschuk)</p>		
1,6	EP6CDTX 5FU (EP6CDTX)	147-150 kW (200-204 PS)	RCZ 16V 208 GTI 308 CC 308 GTI	06/10-12/19		<p><b>02-11519-01</b></p> <p><b>02-38010-03</b></p>	<p><b>08-11542-01</b></p>	<p><b>04-10230-01</b> </p>	<p><b>61-38010-00</b> 98 036 733 80 78 Ø 0,9 mm MLS</p> <p><b>61-38010-10</b> </p> <p>0209.HP 78 Ø 1,3 mm MLS</p>	<p><b>14-32347-01</b> 0204.C1</p>	<p><b>15-11519-01</b> 0249.G9</p>	<p><b>12-37621-01</b> 0956.60</p> <p><b>70-37621-00</b></p>	<p><b>11-37616-01</b> </p> <p>0348.S9</p> <p><b>71-41214-00</b> </p> <p>V7 616 895 80</p> <p><b>71-11545-00</b> </p> <p>1709.45</p>	<p><b>70-31414-10</b></p>	<p><b>81-41219-00</b> </p> <p>16 140 859 80 61x75 A SL RD PTFE (Polytetrafluorethylen)/ACM (Polyacryl-Kautschuk)</p> <p><b>81-38532-00</b> </p> <p>0514.A2 85x105 A SL LD PTFE (Polytetrafluorethylen)/ACM (Polyacryl-Kautschuk)</p>











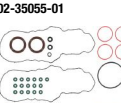

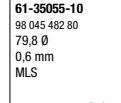
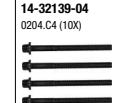

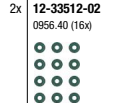
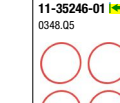
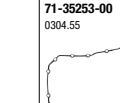
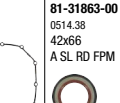
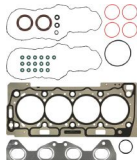



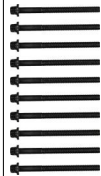



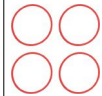



PEUGEOT



Ltr.  1,6 NFP (EC5) 85 kW (115 PS) 308  05/15-06/21





























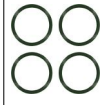

										
		<p><b>08-38532-02</b></p> 		<p><b>61-35055-10</b> 98 045 482 80 79,8 Ø 0,6 mm MLS</p> <p><b>61-35055-20</b>  79,8 Ø 0,9 mm MLS</p> 	<p><b>14-32139-04</b> 0204.C4 (10X)</p> 	<p><b>71-42166-00</b> 2x 0249.C6</p> 	<p><b>12-33512-02</b> 0956.40 (16x)</p>  <p><b>70-33512-00</b> 0956.40</p> 	<p><b>11-35246-01</b>  0348.05</p>  <p><b>71-35067-00</b>  0349.L3</p>  <p><b>71-42093-00</b>   1709.33</p> 	<p><b>70-31414-10</b></p> 	<p><b>81-38533-00</b>  0514.A3 42x66 A SL RD PTFE (Polytetrafluorethylen)/ACM (Polyacryl-Kautschuk)</p>  <p><b>81-38532-00</b>  0514.A2 85x105 A SL LD PTFE (Polytetrafluorethylen)/ACM (Polyacryl-Kautschuk)</p>  <p><b>81-38531-00</b> <b>N</b> 0807.34 38x50 A SL RD PTFE (Polytetrafluorethylen)/ACM (Polyacryl-Kautschuk)</p>  <p><b>81-38657-00</b> <b>N</b> 0236.74 39x50 A SL RD PTFE (Polytetrafluorethylen)/ACM (Polyacryl-Kautschuk)</p> 

1,6 NFR (TU5JP4B) 66-83 kW (90-113 PS) PARTNER PARTNER TEPEE 07/06 207 307











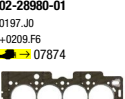

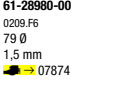
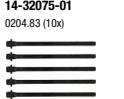
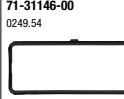
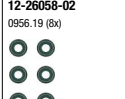





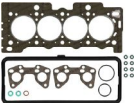



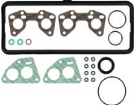

















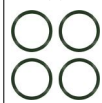











										
	<p><b>02-35055-01</b></p> 	<p><b>08-35253-01</b></p> 		<p><b>61-35055-10</b> 98 045 482 80 79,8 Ø 0,6 mm MLS</p> <p><b>61-35055-20</b>  79,8 Ø 0,9 mm MLS</p> 	<p><b>14-32139-04</b> 0204.C4 (10X)</p> 	<p><b>71-35251-00</b> 2x 0249.A9</p> 	<p><b>12-33512-02</b> 0956.40 (16x)</p>  <p><b>70-33512-00</b> 0956.40</p> 	<p><b>11-35246-01</b>  0348.05</p>  <p><b>71-35067-00</b>  0349.L3</p>  <p><b>71-36469-00</b>   1709.25</p> 	<p><b>71-35253-00</b> 0304.55</p> 	<p><b>81-31863-00</b>  0514.38 42x66 A SL RD FPM</p>  <p><b>81-23708-50</b>  0514.74 85x105 A SL LD FPM</p>  <p><b>81-34146-00</b> <b>N</b> 2x 0807.24 38x50 A SL RD FPM</p> 

PEUGEOT

Ltr.  1,6 NFT (TU5JP) 72 kW (98 PS) 306  10/00-04/02 

										
				<p><b>61-31595-00</b> 0209.W8 79,7 Ø 1,37 mm MLS</p> <p><b>61-31595-10</b>  0209.W9 79,7 Ø 1,57 mm MLS</p> 	<p><b>14-32075-01</b> 0204.83 (10x)</p> 	<p><b>71-31146-00</b> 0249.54</p> 	<p><b>12-26058-02</b> 0956.19 (8x)</p>  <p><b>70-26058-00</b> 0956.19</p> 	<p><b>11-38519-01</b>  0348.P3 (4x)</p>  <p><b>71-35068-00</b>  0349.K1</p>  <p><b>71-36469-00</b>   1709.25</p> 	<p><b>70-31414-10</b></p> 	<p><b>81-38533-00</b>  0514.A3 42x66 A SL RD PTFE (Polytetrafluorethylen)/ACM (Polyacryl-Kautschuk)</p>  <p><b>81-38532-00</b>  0514.A2 85x105 A SL LD PTFE (Polytetrafluorethylen)/ACM (Polyacryl-Kautschuk)</p>  <p><b>81-34403-00</b> <b>N</b> 0236.44 36x50 A SL FPM</p> 

























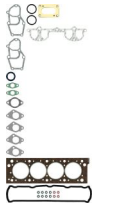
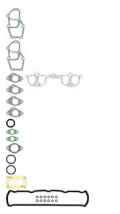

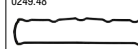
1,6 TU5JP (NFZ) 65-76 kW (88-103 PS) 106 05/93-10/03  
TU5J2 (NFW) 206  
TU5J2 (NFY) 306

										
	<p><b>02-28980-01</b> 0197.J0 +0209.F6   07874</p>  <p><b>02-31595-01</b> 0197.J0 +0209.W8   07875→</p>  <p><b>02-31146-02</b>  0197.J0</p> 	<p><b>08-31859-01</b> </p> 		<p><b>61-28980-00</b> 0209.F6 79 Ø 1,5 mm   07874</p> <p><b>61-28980-10</b> 0209.F7 79 Ø 1,7 mm   07874</p>  <p><b>61-31595-00</b> 0209.W8 79,7 Ø 1,37 mm MLS   07875→</p> <p><b>61-31595-10</b> 0209.W9 79,7 Ø 1,57 mm MLS   07875→</p> 	<p><b>14-32075-01</b> 0204.83 (10x)</p> 	<p><b>71-31146-00</b> 0249.54</p> 	<p><b>12-26058-02</b> 0956.19 (8x)</p>  <p><b>70-26058-00</b> 0956.19</p> 	<p><b>11-38519-01</b>  0348.P3 (4x)</p>  <p><b>71-35249-00</b>  0348.E5   07874</p>  <p><b>71-35248-00</b>  0348.P3   07875→</p>  <p><b>71-31147-00</b>  0349.A6</p>  <p><b>71-35068-00</b>  0349.K1</p>  <p><b>71-36469-00</b>   1709.25</p> 	<p><b>70-31414-10</b></p> 	<p><b>81-31863-00</b>  0514.38 42x66 A SL RD FPM</p>  <p><b>81-23708-50</b>  0514.74 85x105 A SL LD FPM</p>  <p><b>81-26244-10</b> <b>N</b> 0236.21 36x50 A RD ACM</p> 

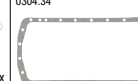

PEUGEOT

Ltr.	Motor	Power	Model	Year	Image 1	Image 2	Image 3	Image 4	Image 5	Image 6	Image 7	Image 8	Image 9	Image 10	Image 11			
1,6	TU5JP4 (NFU)	78-85 kW (106-115 PS)	HOGGAR PARTNER PARTNER COMBISPACE PARTNER TEPEE PARTNER 16V 1007 16V 206 206 CC 16V 206 SW 206 SW 16V 206 16V 207 207 16V 307 307 CC 16V 307 SW 16V 307 16V 308 405	08/92														
						02-35055-01 	08-35253-01 			61-35055-10 98 045 482 80 79,8 Ø 0,6 mm MLS  61-35055-20 79,8 Ø 0,9 mm MLS 	14-32139-04 0204.C4 (10X) 	71-35251-00 0249.A9 2336722  71-42166-00 0249.C6 2336723→ 	12-33512-02 0956.40 (16x) 	11-35246-01 0348.05 	71-35253-00 0304.55 	81-31863-00 0514.38 42x66 A SL RD FPM  81-23708-50 0514.74 85x105 A SL LD FPM  81-34146-00 0807.24 38x50 A SL RD FPM		
1,6	TU5JP4 (NFU)	79 kW (107 PS)	206	06/01-04/09						61-35055-20 79,8 Ø 0,9 mm MLS 								
1,6	TU5J4 (NFU)	87-88 kW (118-120 PS)	106	05/96-07/04		02-31850-01 	08-31859-01 			61-31850-00 0209.Z0 79,7 Ø 1,37 mm MLS 6  61-31850-10 0209.W3 79,7 Ø 1,57 mm MLS 7  61-31850-20 0209.Z1 79,7 Ø 1,77 mm MLS 8 	14-32139-04 0204.C4 (10X) 	70-31414-10 	12-33512-02 0956.40 (16x) 	71-34449-00 0348.L0  71-84609-00 0348.L1  71-34451-00 0349.F9 	70-31414-10 	81-31863-00 0514.38 42x66 A SL RD FPM  81-23708-50 0514.74 85x105 A SL LD FPM  81-34146-00 0807.24 38x50 A SL RD FPM		
1,6	XC5P XC6	48-60 kW (65-82 PS)	J7 J7 Bus 404 404 GT	04/63-03/80														
													71-19231-00 0249.14 		71-17538-10 0349.03 	71-12921-20 0304.44 		

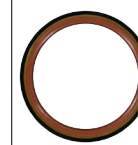
PEUGEOT

<p>Ltr.  1,6 XC7P 44-46 kW (60-63 PS) J7 J7 Bus J9 504  08/68-06/87</p>											
<p>1,6 XU5CP (BAZ) 53-76 kW (72-103 PS) 205 01/87-09/98                  XU5J (180A) 205 GTI                  XU5J (180Z) 309                  XU5M (BDY) 405                  XU5M (BDZ)                  XU5S (171)                  XU51C (B1A)                  XU51C (B1E)                  XU52C/K (B2A)</p>	<p><b>02-25415-03</b> 0197.H6 +0209.E1</p>  <p><b>02-25415-08</b> 0197.H6 +0209.L3</p>  <p><b>02-26237-01</b> 0197.H6</p> 	<p><b>08-25918-05</b></p> 		<p><b>61-25415-30</b> 0209.E1 84 Ø 1,3 mm</p> <p><b>61-25415-40</b> 0209.L3 84 Ø 1,5 mm</p> 	<p><b>14-32079-01</b> 0204.57 (10x)</p>	<p><b>71-26237-00</b> 0249.46</p> 	<p><b>71-19231-00</b> 0249.14</p> 	<p><b>12-23062-01</b> 0956.30 (8x)</p>  <p><b>70-23062-00</b> 0956.05</p> 	<p><b>71-17538-10</b> 4x 0349.03</p>  <p><b>71-31379-10</b> 4x 0348.76</p>  <p><b>71-26236-10</b> 4x 0349.70</p>  <p><b>71-27178-10</b> 16 1710.39</p> 	<p><b>71-25918-30</b> 0304.34</p> 	<p><b>81-25926-10</b> K↔ 0326.12 42x62 A RD FPM</p>  <p><b>81-34456-00</b> K↔ 0127.28 90x110 A SL LD FPM</p> 

PEUGEOT

Ltr.   

1,6 XU5CP (BAZ) 53-77 kW (72-105 PS) 205 10/82-10/90  
 XU5J (B6B) 205 GTI  
 XU5J (180A) 305  
 XU5J (180Z) 309  
 XU5S (171)  
 XU51C (B1A)  
 XU51C (B1D)  
 XU51C (B1E)

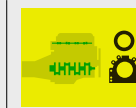
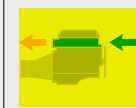

**02-25415-03**  
 0197.H6  
 +0209.E1  



**02-25415-08**  
 0197.H6  
 +0209.L3  

**02-26237-01**  
 0197.H6  



**61-25415-30**  
 0209.E1  
 84 Ø  
 1,3 mm

**61-25415-40**  
 0209.L3  
 84 Ø  
 1,5 mm





**14-32078-01**  
 0204.89 (10x)  



**14-32079-01**  
 0204.57 (10x)  



**71-26237-00**  
 0249.48  



**12-25837-01**  
 0956.22 (8x)  

**70-25837-00**  
 0956.22  

**71-31379-10**    
 0348.76  

**71-26236-10**  4x  
 0348.70  

**71-27178-10**    
 1710.39  

**71-25918-30**  
 0304.34  

**81-25926-10**   
 0326.12  
 42x62  
 A RD FPM  



**81-34456-00**   
 0127.28  
 90x110  
 A SL LD FPM  

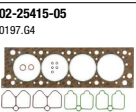

1,6 XU5JP (BFZ) 65-68 kW (88-92 PS) 405 08/92-05/04  
 406





**61-25415-30**  
 0209.E1  
 84 Ø  
 1,3 mm

**61-25415-40**  
 0209.L3  
 84 Ø  
 1,5 mm









**14-32078-01**  
 0204.89 (10x)  





**71-33664-00**  
 0249.71  



**12-25837-01**  
 0956.22 (8x)  

**70-25837-00**  
 0956.22  

**71-33663-00**   2x  
 0348.F6  



**71-33738-00**   2x  
 0348.E6  

**71-35364-00**    
 1723.63  

**71-25918-30**  
 0304.34  

























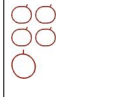













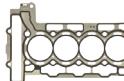
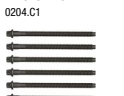

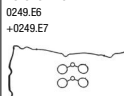

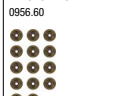





















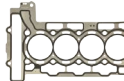
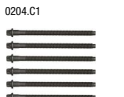

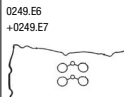





**81-25926-10**   
 0326.12  
 42x62  
 A RD FPM  

**81-34456-00**   
 0127.28  
 90x110  
 A SL LD FPM  

**81-26244-10**   
 0236.21  
 36x50  
 A RD ACM  

PEUGEOT													
Ltr.													
1,6 XU5S (171)	71 kW (97 PS)	305	10/82-06/84		<b>02-25415-03</b> 0209.H6 +0209.E1 	<b>08-25918-05</b> 	<b>61-25415-30</b> 0209.E1 84 Ø 1,3 mm  <b>61-25415-40</b> 0209.L3 84 Ø 1,5 mm 	<b>14-32078-01</b> 0204.89 (10x) 	<b>71-26237-00</b> 0249.48 	<b>12-25837-01</b> 0956.22 (8x) 	<b>71-31379-10</b> 0348.76 	<b>71-25918-30</b> 0304.34 	<b>81-25826-10</b> 0326.12 42x62 A RD FPM   <b>81-34456-00</b> 0127.28 90x110 A SL LD FPM 
1,6 1580 SPI (222A2)	58 kW (79 PS)	EXPERT	02/96-09/00		<b>01-31755-03</b> 	<b>02-31755-06</b> 0197.V3 	<b>61-31755-00</b> 0209.P9 87 Ø 1,8 mm 	<b>71-31729-00</b>   <b>71-31732-00</b> 	<b>12-25837-01</b> 0956.22 (8x) 	<b>71-35716-00</b> 	<b>71-31742-00</b> 0304.49 	<b>81-35883-00</b> 30x52 AB SL RD FPM 	













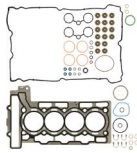



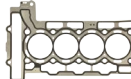

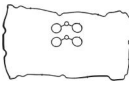
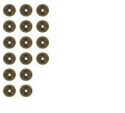













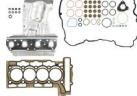



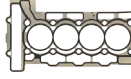

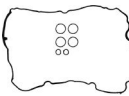



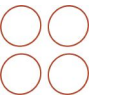









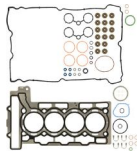
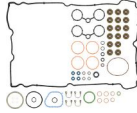



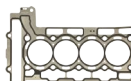

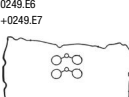





PEUGEOT

<p>Ltr.  1.6 4A92 86 kW (117 PS) 4008 05/12</p>	 <b>01-34240-02</b> 16 076 039 80 				 <b>61-34240-00</b> 16 075 925 80 76 Ø 	 <b>14-10276-01</b> 16 075 990 80 (10x) 	 <b>71-10223-00</b> 16 075 921 80 	 <b>12-10031-01</b> 16 081 662 80 (16x)  <b>70-10031-00</b> 16 081 662 80 16x 	 <b>11-10030-01</b>  16 075 918 80 (4X)  <b>71-10222-00</b>  16 075 911 80 	 <b>70-31414-10</b> 	 <b>81-39028-00</b>  16 075 932 80 29x48 A RD  <b>81-10389-00</b>  16 078 540 80 LD FPM 
<p>1.6 5FA (EP6CDT) 92 kW (125 PS) 308 09/13-06/21</p>				 <b>04-10230-01</b>  	 <b>61-38010-00</b> 98 036 733 80 78 Ø 0,9 mm MLS <b>61-38010-10</b> 0209.HP 78 Ø 1,3 mm MLS 	 <b>14-32347-01</b> 0204.C1 	 <b>15-37614-01</b> 0249.E6 +0249.E7 	 <b>12-37621-01</b> 0956.60  <b>70-37621-00</b> 16x 	 <b>11-37616-01</b>  0348.S9  <b>71-12290-00</b>  96 781 882 80 	 <b>70-31414-10</b> 	 <b>81-41219-00</b>  16 140 859 80 61x75 A SL RD PTFE (Polytetrafluorethylen)/ACM (Polyacryl-Kautschuk)  <b>81-38532-00</b>  0514.A2 85x105 A SL LD PTFE (Polytetrafluorethylen)/ACM (Polyacryl-Kautschuk) 
<p>1.6 5FD (EP6DTS) 103-152 kW (140-207 PS) RCZ 16V 02/06                  5FR (EP6DT) 207                  5FT (EP6DT) 207 CC Turbo 16V                  5FV (EP6CDT) 207 CC 16V                  5FX (EP6DT) 207 TURBO                  5FY (EP6DTS) 207 16V                  208                  3008 THP                  308                  308 CC 16V                  308 16V                  5008                  5008 16V                  508</p>	 <b>02-38010-01</b>  <b>02-38010-02</b> 			 <b>04-10230-01</b>  	 <b>61-38010-00</b> 98 036 733 80 78 Ø 0,9 mm MLS <b>61-38010-10</b>  0209.HP 78 Ø 1,3 mm MLS 	 <b>14-32347-01</b> 0204.C1 	 <b>15-37614-01</b> 0249.E6 +0249.E7 	 <b>12-37621-01</b> 0956.60  <b>70-37621-00</b> 16x 	 <b>11-37616-01</b>  0348.S9  <b>71-41214-00</b>  V7 616 895 80 	 <b>70-31414-10</b> 	 <b>81-41219-00</b>  16 140 859 80 61x75 A SL RD PTFE (Polytetrafluorethylen)/ACM (Polyacryl-Kautschuk)  <b>81-38532-00</b>  0514.A2 85x105 A SL LD PTFE (Polytetrafluorethylen)/ACM (Polyacryl-Kautschuk) 























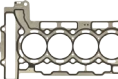



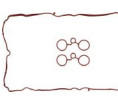

















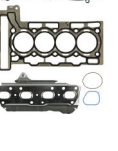



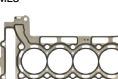

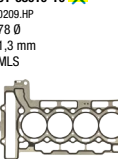

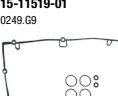



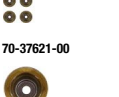













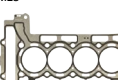

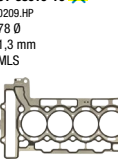
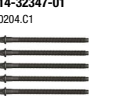
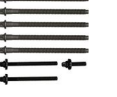
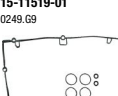

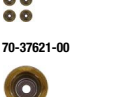

PEUGEOT														
1,6	5FE (EP6CDTM) 5FE (EP6CDTMD) 5FM (EP6CDTM)	110-127 kW (150-173 PS)	RCZ RCZ 16V 208 3008 THP 308 408 THP 508	06/09										
Ltr.														
1,6	5FG (EP6CDTR)	199 kW (270 PS)	RCZ	06/13-12/15										
1,6	5FH (EP6C) 5FK (EP6CB) 5FW (EP6)	72-88 kW (98-120 PS)	PARTNER PARTNER TEEPE 207 308 16V 508	03/07										



PEUGEOT













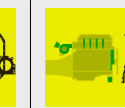

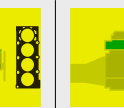

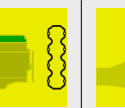
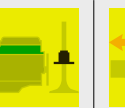
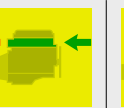

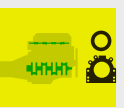
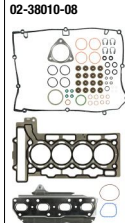

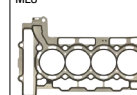
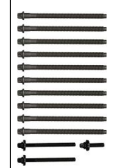
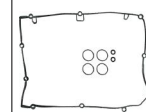

<p>Ltr.  1,6 5FN (EP6CDT) 110 kW (150 PS) 508 11/10-12/18 </p>		<p><b>02-38010-01</b></p>  <p><b>02-38010-02</b></p> 	<p><b>08-11542-01</b></p> 		<p><b>61-38010-00</b> 98 036 733 80 78 Ø 0,9 mm MLS</p> <p><b>61-38010-10</b> </p> <p>0209.HP 78 Ø 1,3 mm MLS</p> 	<p><b>14-32347-01</b> 0204.C1</p> 	<p><b>15-37614-01</b> 0249.E6 +0249.E7</p> 	<p><b>12-37621-01</b> 0956.60</p>  <p><b>70-37621-00</b></p> 	<p><b>11-37616-01</b> </p> <p>0348.S9</p>  <p><b>71-41214-00</b>  </p> <p>V7 616 895 80</p> 	<p><b>70-31414-10</b></p> 	<p><b>81-41219-00</b> </p> <p>16 140 859 80 61x75 A SL RD PTFE (Polytetrafluorethylen)/ACM (Polyacryl-Kautschuk)</p>  <p><b>81-38532-00</b> </p> <p>0514.A2 85x105 A SL LD PTFE (Polytetrafluorethylen)/ACM (Polyacryl-Kautschuk)</p> 
<p>1,6 5FW (EP6) 88 kW (120 PS) 207 CC 16V 207 16V 3008 5008 16V 02/07-03/17</p>		<p><b>02-38005-01</b></p>  <p><b>02-38005-02</b></p>  <p><b>02-38005-03</b></p> 	<p><b>08-11542-01</b></p> 		<p><b>61-38005-00</b> 0209.EW 78 Ø 0,9 mm MLS</p> <p><b>61-38005-10</b> </p> <p>78 Ø 1,2 mm MLS</p> 	<p><b>14-32347-01</b> 0204.C1</p> 	<p><b>15-37633-01</b> 0249.F4</p> 	<p><b>12-37621-01</b> 0956.60</p>  <p><b>70-37621-00</b></p> 	<p><b>11-37632-01</b> </p> <p>0348.T4</p>  <p><b>71-41213-00</b>  </p> <p>1723.CH</p> 	<p><b>70-31414-10</b></p> 	<p><b>81-41219-00</b> </p> <p>16 140 859 80 61x75 A SL RD PTFE (Polytetrafluorethylen)/ACM (Polyacryl-Kautschuk)</p>  <p><b>81-38532-00</b> </p> <p>0514.A2 85x105 A SL LD PTFE (Polytetrafluorethylen)/ACM (Polyacryl-Kautschuk)</p> 
<p>1,6 5FX (EP6DT) 110 kW (150 PS) 3008 THP 06/09-08/16</p>		<p><b>02-38010-01</b></p>  <p><b>02-38010-02</b></p> 	<p><b>04-10230-01</b> </p> 		<p><b>61-38010-00</b> 98 036 733 80 78 Ø 0,9 mm MLS</p> <p><b>61-38010-10</b> </p> <p>0209.HP 78 Ø 1,3 mm MLS</p> 	<p><b>14-32347-01</b> 0204.C1</p> 	<p><b>15-37614-01</b> 0249.E6 +0249.E7</p> 	<p><b>12-37621-01</b> 0956.60</p>  <p><b>70-37621-00</b></p> 	<p><b>11-37616-01</b> </p> <p>0348.S9</p>  <p><b>71-37628-00</b>   </p> <p>0348.S7</p> <p><b>71-41214-00</b>  </p> <p>V7 616 895 80</p> 	<p><b>70-31414-10</b></p> 	<p><b>81-41219-00</b> </p> <p>16 140 859 80 61x75 A SL RD PTFE (Polytetrafluorethylen)/ACM (Polyacryl-Kautschuk)</p>  <p><b>81-38532-00</b> </p> <p>0514.A2 85x105 A SL LD PTFE (Polytetrafluorethylen)/ACM (Polyacryl-Kautschuk)</p> 

PEUGEOT











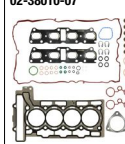

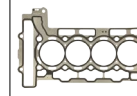
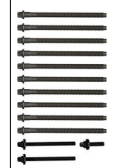
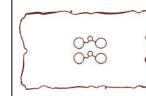
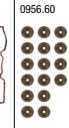

<p>Ltr.   </p> <p>1,6 5GL (EP6FDTMD) 5GX (EP6FDTMD)</p> <p>100-112 kW (136-152 PS)</p> <p>3008 THP 308 5008 508 THP</p> <p>09/13</p>		 <p>02-38010-06</p> 	 <p>08-10148-01</p> 	 <p>04-10230-01 </p> 	 <p>61-38010-00 98 036 733 80 78 Ø 0,9 mm MLS</p> <p>61-38010-10 0209.HP 78 Ø 1,3 mm MLS</p> 	 <p>14-32347-01 0204.C1</p> 	 <p>15-12291-01 98 052 642 80</p> 	 <p>12-37621-01 0956.60</p>  <p>70-37621-00</p> 	 <p>11-37616-01 </p> <p>0348.S9</p>  <p>71-12290-00 </p> <p>96 781 882 80</p> 	 <p>70-31414-10</p> 	 <p>81-41219-00 </p> <p>16 140 859 80 61x75 A SL RD PTFE (Polytetrafluorethylen)/ACM (Polyacryl-Kautschuk)</p>  <p>81-38532-00 </p> <p>0514.A2 85x105 A SL LD PTFE (Polytetrafluorethylen)/ACM (Polyacryl-Kautschuk)</p> 
<p>1,6 5GM (EP6FDTX) 5GT (EP6FDTX)</p> <p>151-155 kW (205-211 PS)</p> <p>308</p> <p>06/14</p>		 <p>02-38010-08</p> 	 <p>08-10148-01</p> 	 <p>61-38010-00 98 036 733 80 78 Ø 0,9 mm MLS</p> <p>61-38010-10 </p> <p>0209.HP 78 Ø 1,3 mm MLS</p> 	 <p>14-32347-01 0204.C1</p> 	 <p>15-11519-01 0249.G9</p> 	 <p>12-37621-01 0956.60</p>  <p>70-37621-00</p> 	 <p>11-37616-01 </p> <p>0348.S9</p>  <p>71-12290-00 </p> <p>96 781 882 80</p> 	 <p>70-31414-10</p> 	 <p>81-41219-00 </p> <p>16 140 859 80 61x75 A SL RD PTFE (Polytetrafluorethylen)/ACM (Polyacryl-Kautschuk)</p>  <p>81-38532-00 </p> <p>0514.A2 85x105 A SL LD PTFE (Polytetrafluorethylen)/ACM (Polyacryl-Kautschuk)</p> 	
<p>1,6 5GN (EP6FDTR) 5GP (EP6FDTR)</p> <p>184-200 kW (250-272 PS)</p> <p>308 GTI</p> <p>06/15-06/21</p>				 <p>61-38010-00 98 036 733 80 78 Ø 0,9 mm MLS</p> <p>61-38010-10 </p> <p>0209.HP 78 Ø 1,3 mm MLS</p> 	 <p>14-32347-01 0204.C1</p> 	 <p>15-11519-01 0249.G9</p> 	 <p>12-37621-01 0956.60</p>  <p>70-37621-00</p> 	 <p>11-37616-01 </p> <p>0348.S9</p>  <p>71-12286-00 </p> <p>98 124 032 80</p> 	 <p>70-31414-10</p> 	 <p>81-41219-00 </p> <p>16 140 859 80 61x75 A SL RD PTFE (Polytetrafluorethylen)/ACM (Polyacryl-Kautschuk)</p>  <p>81-38532-00 </p> <p>0514.A2 85x105 A SL LD PTFE (Polytetrafluorethylen)/ACM (Polyacryl-Kautschuk)</p> 	

PEUGEOT















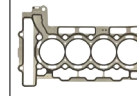
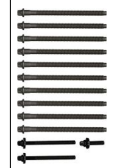
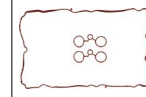
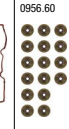

Ltr.  1,6 5GR (EP6FDTX) 153 kW (208 PS) 208  10/14-12/19 

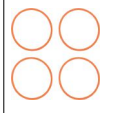
											
	02-38010-08 	08-10148-01 		61-38010-00 98 036 733 80 78 Ø 0,9 mm MLS  61-38010-10 0209.HP 78 Ø 1,3 mm MLS 	14-32347-01 0204.C1 	15-11519-01 0249.G9 	12-37621-01 0956.60   70-37621-00 	11-37616-01  0348.S9   71-12290-00  96 781 882 80 	70-31414-10 	81-41219-00  16 140 859 80 61x75 A SL RD PTFE (Polytetrafluorethylen)/ACM (Polyacryl-Kautschuk)   81-38532-00  0514.A2 85x105 A SL LD PTFE (Polytetrafluorethylen)/ACM (Polyacryl-Kautschuk) 	

1,6 5GV (EP6FDTM) 121-127 kW (165-173 PS) 2008 09/09  
3008  
308  
408  
5008 THP  
508  
508 THP













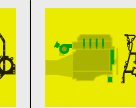

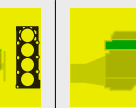

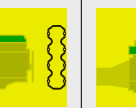
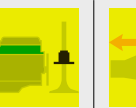
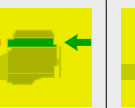

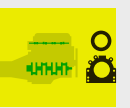

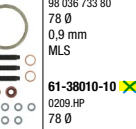
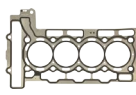

	02-38010-07 	08-10148-01 	04-10230-01  	61-38010-00 98 036 733 80 78 Ø 0,9 mm MLS  61-38010-10 0209.HP 78 Ø 1,3 mm MLS 	14-32347-01 0204.C1 	15-12291-01 98 052 642 80 	12-37621-01 0956.60   70-37621-00 	11-37616-01  0348.S9   11-17489-01  	70-31414-10 	81-41219-00  16 140 859 80 61x75 A SL RD PTFE (Polytetrafluorethylen)/ACM (Polyacryl-Kautschuk)   81-38532-00  0514.A2 85x105 A SL LD PTFE (Polytetrafluorethylen)/ACM (Polyacryl-Kautschuk) 
---	--	--	--	---	---	---	---	---	--	---

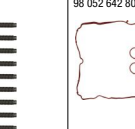
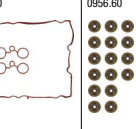
1,6 5GZ (EP6FDT) 120-121 kW (163-165 PS) 2008 09/11  
208  
3008  
3008 T  
5008  
508

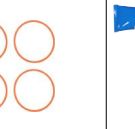

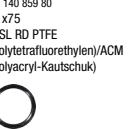

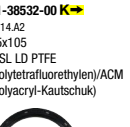









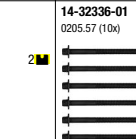
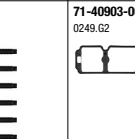
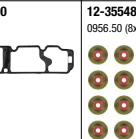
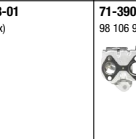
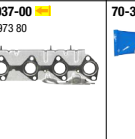

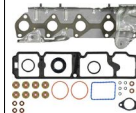

	02-38010-04 	08-10148-01 	04-10230-01  	61-38010-00 98 036 733 80 78 Ø 0,9 mm MLS  61-38010-10  0209.HP 78 Ø 1,3 mm MLS 	14-32347-01 0204.C1 	15-12291-01 98 052 642 80 	12-37621-01 0956.60   70-37621-00 	11-37616-01  0348.S9   71-41214-00  V7 616 895 80 	70-31414-10 	81-41219-00  16 140 859 80 61x75 A SL RD PTFE (Polytetrafluorethylen)/ACM (Polyacryl-Kautschuk)   81-38532-00  0514.A2 85x105 A SL LD PTFE (Polytetrafluorethylen)/ACM (Polyacryl-Kautschuk) 
--	---	---	---	---	--	--	--	---	---	---

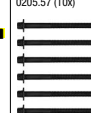
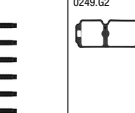
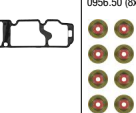
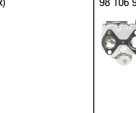
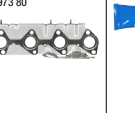
PEUGEOT

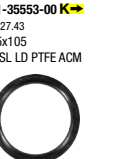

Ltr.  1,6 5GZ (EP6FDT) 120-121 kW (163-165 PS) 408 THP 5008 THP 01/11

											
	02-38010-04 	08-10148-01 	04-10230-01 	61-38010-00 98 036 733 80 78 Ø 0,9 mm MLS  61-38010-10  0209.HP 78 Ø 1,3 mm MLS 	14-32347-01 0204.C1 	15-12291-01 98 052 642 80 	12-37621-01 0956.60 	70-37621-00 	11-37616-01  0348.S9 	70-31414-10 	81-41219-00  K 16 140 859 80 61x75 A SL RD PTFE (Polytetrafluorethylen)/ACM (Polyacryl-Kautschuk)  81-38532-00  K 0514.A2 85x105 A SL LD PTFE (Polytetrafluorethylen)/ACM (Polyacryl-Kautschuk) 

1,6 9HC (DV6C) 55-85 kW (75-116 PS) EXPERT HDI 90 01/07  
 9HF (DV6TDE) EXPERT TEPEE HDI  
 9HF (DV6DU) PARTNER  
 9HH (DV6DUM) PARTNER HDI  
 9HJ (DV6TDEM) PARTNER HDI 75  
 9HM (DV6UC) PARTNER TEPEE HDI  
 9HN (DV6TED) RIFTER HDI  
 9HP (DV6TED) 2008 HDI  
 207 HDI  
 208  
 208 HDI  
 3008 HDI 115  
 301 HDI 90  
 308  
 308 HDI  
 308 HDI 115  
 308 HDI 92  
 4008 HDI



											
	02-40903-02 	08-42514-01 	04-10340-01 	61-10039-00 0209.JN 76 Ø 1,25 mm MLS  61-10039-10 0209.JP 76 Ø 1,3 mm MLS  61-10039-20 0209.JQ 76 Ø 1,35 mm MLS  61-10039-30 0209.JR 76 Ø 1,4 mm MLS  61-10039-40 0209.JS 76 Ø 1,45 mm MLS 	14-32336-01 0205.57 (10x) 	71-40903-00 0249.G2 	12-35548-01 0956.50 (8x) 	70-35548-00 0956.50 	71-39037-00  98 106 973 80 	70-31414-10 	81-35554-00  K 0127.42 40x55 A SL RD PTFE ACM  81-35552-00  N 0127.43 85x105 A SL LD PTFE ACM  81-35552-00  N 0807.30 27x47 A SL RD PTFE ACM 

PEUGEOT

Ltr.  1,6  55-84 kW (75-115 PS)  08/05

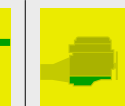
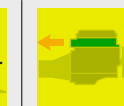
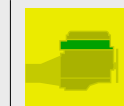
PARTNER HDI  
PARTNER HDI 75  
PARTNER TEPEE HDI  
2008 HDI  
208 HDI  
208 HDI 75  
3008 HDI  
308 HDI  
4008 HDI  
408 HDI  
5008 HDI  
508 HDI





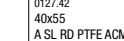
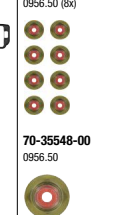
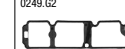
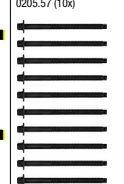
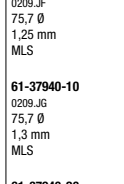
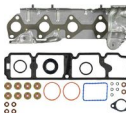

















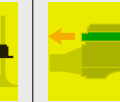
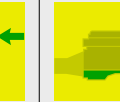
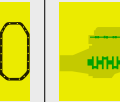



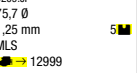

02-40903-02  
08-42514-01  
04-10340-01   
61-37940-00  
0209.JF  
75,7 Ø  
1,25 mm  
MLS  
61-37940-10  
0209.JG  
75,7 Ø  
1,3 mm  
MLS  
61-37940-20  
0209.JH  
75,7 Ø  
1,35 mm  
MLS  
61-37940-30  
0209.JJ  
75,7 Ø  
1,4 mm  
MLS  
61-37940-40  
0209.JK  
75,7 Ø  
1,45 mm  
MLS  





81-35554-00   
0127.42  
40x55  
A SL RD PTFE ACM  
  
81-35553-00   
0127.43  
85x105  
A SL LD PTFE ACM  
  
81-35552-00   
0807.30  
27x47  
A SL RD PTFE ACM  

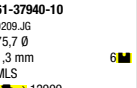
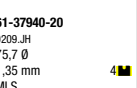
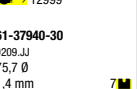

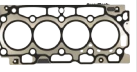
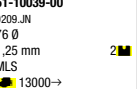
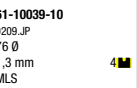
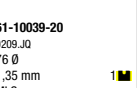
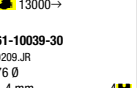
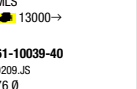
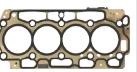
PEUGEOT













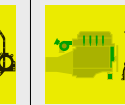
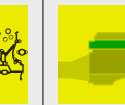
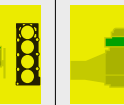

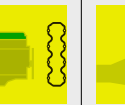
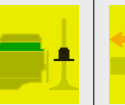
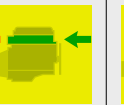





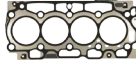





Ltr.  1,6 9HL (DV6C) 82-85 kW (111-116 PS) PARTNER HDI PARTNER TEPEE HDI 408 HDI 508 508 HDI 08/10 

										
	02-40903-02 	08-42514-01 	04-10340-01 	61-37940-00 0209.JF 75,7 Ø 1,25 mm MLS  12999	14-32336-01 0205.57 (10x) 	71-40903-00 0249.G2 	12-35548-01 0956.50 (8x)  70-35548-00 0956.50 8x 	71-39037-00  98 106 973 80	70-31414-10 	81-35554-00  0127.42 40x55 A SL RD PTFE ACM 81-35553-00  0127.43 85x105 A SL LD PTFE ACM 81-35552-00  0807.30 27x47 A SL RD PTFE ACM 
				61-37940-10 0209.JG 75,7 Ø 1,3 mm MLS  12999						
				61-37940-20 0209.JH 75,7 Ø 1,35 mm MLS  12999						
				61-37940-30 0209.JJ 75,7 Ø 1,4 mm MLS  12999						
				61-37940-40 0209.JK 75,7 Ø 1,45 mm MLS  12999						
										
				61-10039-00 0209.JN 76 Ø 1,25 mm MLS  13000→						
				61-10039-10 0209.JP 76 Ø 1,3 mm MLS  13000→						
				61-10039-20 0209.JQ 76 Ø 1,35 mm MLS  13000→						
				61-10039-30 0209.JR 76 Ø 1,4 mm MLS  13000→						
				61-10039-40 0209.JS 76 Ø 1,45 mm MLS  13000→						
										



**PEUGEOT**



















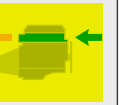



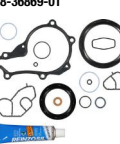







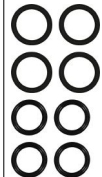

Ltr.  1,6 9HR (DV6C) 82-84 kW (111-115 PS) 207 HDI 207 HDI 110 208 3008 HDI 308 HDI 5008 HDI 508 HDI

 06/09-12/19

											
	<p><b>02-40903-01</b></p> 	<p><b>08-42514-01</b></p> 	<p><b>04-10340-01</b> </p> 	<p><b>61-37940-00</b> 0209.JF 75,7 Ø 1,25 mm MLS</p> <p><b>61-37940-10</b> 0209.JG 75,7 Ø 1,3 mm MLS</p> <p><b>61-37940-20</b> 0209.JH 75,7 Ø 1,35 mm MLS</p> <p><b>61-37940-30</b> 0209.JJ 75,7 Ø 1,4 mm MLS</p> <p><b>61-37940-40</b> 0209.JK 75,7 Ø 1,45 mm MLS</p> 	<p><b>14-32336-01</b> 0205.57 (10x)</p> 	<p><b>71-40903-00</b> 0249.G2</p> 	<p><b>12-35548-01</b> 0956.50 (8x)</p> 	<p><b>71-38503-00</b> </p> <p>0349.N5  12215</p>  <p><b>71-39037-00</b> </p> <p>98 106 973 80  12216 →</p> 	<p><b>70-31414-10</b></p> 	<p><b>81-35554-00</b> </p> <p>0127.42 40x55 A SL RD PTFE ACM</p>  <p><b>81-35553-00</b> </p> <p>0127.43 85x105 A SL LD PTFE ACM</p>  <p><b>81-35552-00</b> </p> <p>0807.30 27x47 A SL RD PTFE ACM</p> 	



PEUGEOT













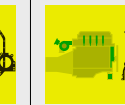
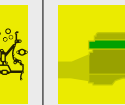
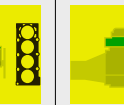

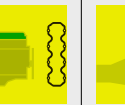
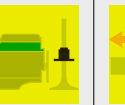
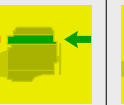

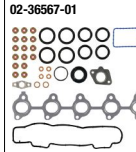



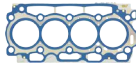
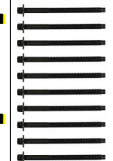

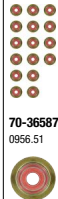

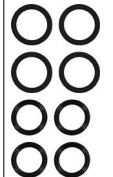

Ltr.  1,6 9HS (DV6TED4BU) 66 kW (90 PS) PARTNER HDI 16V  04/08

										
	<p><b>02-36567-01</b></p> 	<p><b>08-36869-01</b></p> 	<p><b>04-10043-01</b> </p> 	<p><b>61-36265-00</b> 0209.CA 76 Ø 1,25 mm MLS</p> <p><b>61-36265-10</b> 0209.CC 76 Ø 1,3 mm MLS</p> <p><b>61-36265-20</b> 0209.CE 76 Ø 1,35 mm MLS</p> <p><b>61-36265-30</b> 0209.CF 76 Ø 1,4 mm MLS</p> <p><b>61-36265-40</b> 0209.CG 76 Ø 1,45 mm MLS</p> <p><b>61-36265-50</b> 0209.HG 76 Ø 1,5 mm MLS</p> <p><b>61-36265-60</b> 0209.HF 76 Ø 1,55 mm MLS</p> <p><b>61-36265-70</b> 0209.HE 76 Ø 1,6 mm MLS</p> <p><b>61-36265-75</b> 0209.HC 76 Ø 1,65 mm MLS</p> 	<p><b>14-32336-01</b> 0205.57 (10x)</p> 	<p><b>71-36567-00</b> 0249.C2</p> 	<p><b>12-36587-01</b> 0956.51 (16x)</p> <p><b>70-36587-00</b> 0956.51</p> 	<p><b>11-11022-01</b> </p>  <p><b>40-76240-00</b>  4x 0348.R5</p> <p><b>40-76919-00</b>  4x 0348.R4</p> <p><b>71-35487-00</b>  0349.J8</p> 	<p><b>70-31414-10</b></p> 	<p><b>81-35554-00</b> </p> <p>0127.42 40x55 A SL RD PTFE ACM</p>  <p><b>81-35553-00</b> </p> <p>0127.43 85x105 A SL LD PTFE ACM</p>  <p><b>81-35552-00</b> </p> <p>0807.30 27x47 A SL RD PTFE ACM</p> 



PEUGEOT

Ltr.  1,6 9HW (DV6BTD4) 55 kW (75 PS) PARTNER HDI  08/05

											
	<p><b>02-36567-01</b></p> 	<p><b>08-36869-01</b></p> 	<p><b>04-10043-01</b> </p> 	<p><b>61-36265-00</b> 0209.CA 76 Ø 1,25 mm MLS</p> <p><b>61-36265-10</b> 0209.CC 76 Ø 1,3 mm MLS</p> <p><b>61-36265-20</b> 0209.CE 76 Ø 1,35 mm MLS</p> <p><b>61-36265-30</b> 0209.CF 76 Ø 1,4 mm MLS</p> <p><b>61-36265-40</b> 0209.CG 76 Ø 1,45 mm MLS</p> <p><b>61-36265-50</b> 0209.HG 76 Ø 1,5 mm MLS</p> <p><b>61-36265-60</b> 0209.HF 76 Ø 1,55 mm MLS</p> <p><b>61-36265-70</b> 0209.HE 76 Ø 1,6 mm MLS</p> <p><b>61-36265-75</b> 0209.HC 76 Ø 1,65 mm MLS</p> 	<p><b>14-32206-01</b> 0204.A2 (10x)</p> 	<p><b>71-36567-00</b> 0249.C2</p> 	<p><b>12-36587-01</b> 0956.S1 (16x)</p> <p><b>70-36587-00</b> 0956.S1</p> 	<p><b>11-11022-01</b> </p>  <p><b>40-76240-00</b>  4x 0348.R5</p> <p><b>40-76919-00</b>  4x 0348.R4</p> <p><b>71-35487-00</b>  0349.J8</p> 	<p><b>70-31414-10</b></p> 	<p><b>81-35554-00</b> </p> <p>0127.42 40x55 A SL RD PTFE ACM</p>  <p><b>81-35553-00</b> </p> <p>0127.43 85x105 A SL LD PTFE ACM</p>  <p><b>81-35552-00</b> </p> <p>0807.30 27x47 A SL RD PTFE ACM</p> 	

**PEUGEOT**

Ltr.  EW7A (6FY) 92 kW (125 PS) 407 SW 16V 407 16V 08/05-12/10 

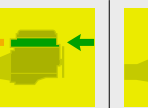
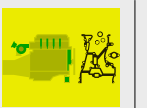

1,8 EW7A (6FY) 92 kW (125 PS) 407 SW 16V 407 16V 08/05-12/10

**61-37355-00**  
0209.FR  
MLS

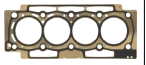

**14-32342-01**  
0204.A3 (10x)



**12-34439-01**  
0956.45 (16x)



**71-38549-00**  4x  
0348.S2



**71-34992-00**   
0349.L4



**70-31414-10**



**81-34454-10**   
16 089 406 80  
40x55  
A SL RD PTFE



**81-34456-00**   
0127.28  
90x110  
A SL LD FPM

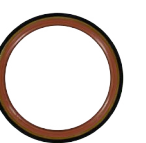

**81-34403-00** **N**  
0236.44  
36x50  
A SL FPM



**81-38657-00** **N**  
0236.74  
39x50  
A SL RD PTFE  
(Polytetrafluorethylen)/ACM  
(Polyacryl-Kautschuk)



1,8 EW7J4 (6FZ) 85 kW (116 PS) 406 406 16V 407 407 SW 09/00-07/05

**01-35820-01**  
0197.Y1  
+0209.QG  
+0249.A4  
+0249.A5

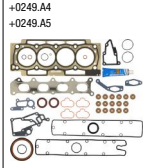

**02-35820-01**



**08-37006-01**



**61-35820-00**  
0209.0G  
83 0  
MLS



**14-32234-01**  
0204.A7 (10x)



**71-34452-00** **R**  
0249.A5

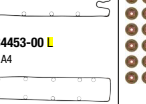

**71-34453-00** **L**  
0249.A4



**12-34439-01**  
0956.45 (16x)



**71-35903-00**  4x  
0348.P1



**71-33853-00**   
0349.H8



**70-31414-10**



**81-34454-10**   
16 089 406 80  
40x55  
A SL RD PTFE





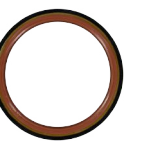



















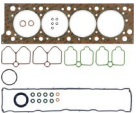





















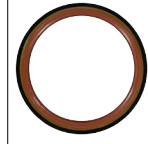





**81-34456-00**   
0127.28  
90x110  
A SL LD FPM





**81-34403-00** **N** 2x  
0236.44  
36x50  
A SL FPM



PEUGEOT

<p>Ltr.  KF5 KF6</p> <p>71 kW (97 PS)</p> <p>504</p> <p>07/68-02/71</p>											
<p>1,8 L6A (XU7JP) XU7JP (LFZ)</p> <p>74-77 kW (101-105 PS)</p> <p>EXPERT 306 405 406</p> <p>01/93-04/02</p>		<p>02-25415-05 0197.G4</p> 	<p>08-25918-05</p> 		<p>61-25415-30 0209.E1 84 Ø 1,3 mm</p> <p>61-25415-40 0209.L3 84 Ø 1,5 mm</p> 	<p>14-32079-01 0204.57 (10x) ⇒ 03/97</p> <p>14-32078-01 0204.89 (10x) ⇒ 04/97 →</p> 	<p>71-19231-00 0249.14</p> 	<p>12-25837-01 0956.22 (8x)</p>  <p>70-25837-00 0956.22</p> 	<p>71-22583-10  4x 0348.18</p>  <p>71-17538-10  4x 0349.03</p>  <p>71-33738-00  2x 0348.E6</p>  <p>71-35364-00  8x 1723.63</p> 	<p>71-12921-20 0304.44</p>  <p>71-25918-30 0304.34</p> 	<p>81-25926-10  </p> <p>0326.12 42x62 A RD FPM</p>  <p>81-34456-00  </p> <p>0127.28 90x110 A SL LD FPM</p>  <p>81-26244-10 <b>N</b></p> <p>0236.21 36x50 A RD ACM</p> 
<p>1,8 XM XM7</p> <p>53-65 kW (72-88 PS)</p> <p>404 504 505</p> <p>07/68-10/99</p>					<p>61-22745-00 86,7 Ø</p> 		<p>71-19231-00 0249.14</p> 		<p>71-17538-10  4x 0349.03</p> 	<p>71-12921-20 0304.44</p> 	
<p>1,8 XM7P</p> <p>48 kW (65 PS)</p> <p>J7 J7 Bus</p> <p>07/70-03/80</p>							<p>71-19231-00 0249.14</p> 	<p>12-23062-01 0956.30 (8x)</p>  <p>70-23062-00 0956.05</p> 	<p>71-17538-10  4x 0349.03</p> 	<p>71-12921-20 0304.44</p> 	<p>81-25926-10  </p> <p>0326.12 42x62 A RD FPM</p> 

PEUGEOT

Ltr.  

1,8 XUD7 (A9A) 43-44 kW (58-60 PS) PARTNER D 11/82-12/02  
 XUD7 (161A) 205 D  
 161 (XUD7) 305 D  
 306 D  
 309 D  
 405 D

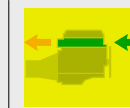

02-25942-03  
 0197.37  
 02-25942-04  
 0197.37  
 +0956.22 (8x)

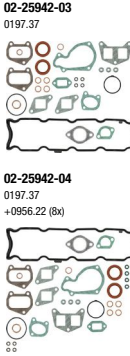

61-29145-10  
 0209.F9  
 82 Ø  
 1,6 mm

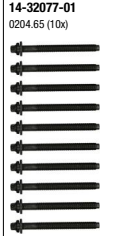

61-29145-20  
 0209.G0  
 82 Ø  
 1,7 mm



61-31060-00  
 0209.S0  
 82 Ø  
 1,4 mm



61-31060-10  
 0209.S1  
 82 Ø  
 1,45 mm

61-31060-20  
 0209.S2  
 82 Ø  
 1,5 mm

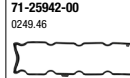
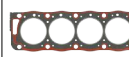

61-31060-30  
 0209.S3  
 82 Ø  
 1,55 mm

61-31060-40  
 0209.S4  
 82 Ø  
 1,6 mm





71-33156-00    
 0348.98



71-33157-00    
 0348.99





71-25919-30    
 0349.47





71-25918-30  
 0304.34



81-25926-10    
 0326.12  
 42x62  
 A RD FPM



81-34456-00    
 0127.28  
 90x110  
 A SL LD FPM

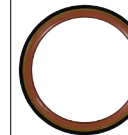

81-21798-30 **N**  
 0236.14  
 35x50  
 A SL WD ACM



1,8 XUD7T 57-66 kW (78-90 PS) 205 10/87-09/98  
 XUD7TE (AJZ) 205 DT  
 XUD7TE (ABA) 205 TD  
 XUD7TE (ABB) 309 TD  
 405 D  
 405 DT  
 405 TD

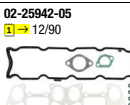

61-33670-00  
 0209.00  
 82 Ø  
 1,54 mm



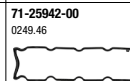

61-33670-10  
 0209.01  
 82 Ø  
 1,64 mm



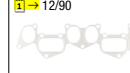

71-33682-00    
 0348.89

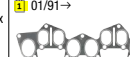

71-33683-00    
 0348.J0  
 01/91 →





50-92244-00    
 1721.01





71-25918-30  
 0304.34



81-25926-10    
 0326.12  
 42x62  
 A RD FPM



81-34456-00    
 0127.28  
 90x110  
 A SL LD FPM

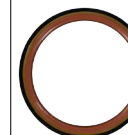



81-21798-30 **N**  
 0236.14  
 35x50  
 A SL WD ACM





**PEUGEOT**

Ltr.  1.8 XU7JB (LFX) 66 kW (90 PS) PARTNER 406  03/97-10/04



**02-25415-09**  
  
  

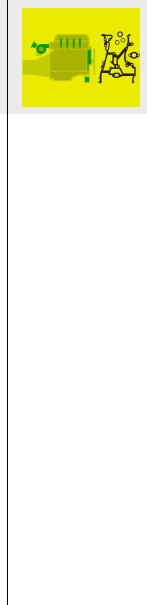

**08-25918-05**  
  
  







**61-25415-30**  
 0209.E1  
 84 Ø  
 1,3 mm  
  
**61-25415-40**  
 0209.L3  
 84 Ø  
 1,5 mm  









**71-33664-00**  
 0249.71  

**12-25837-01**  
 0956.22 (8x)  
  
**70-25837-00**  
 0956.22  

**71-34418-00**  4x  
 0348.L7  
  
**71-35364-00**  1723.63  
 8x 

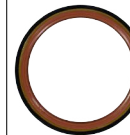
**71-25918-30**  
 0304.34  



**81-25926-10**   
 0326.12  
 42x62  
 A RD FPM  
  
**81-34456-00**   
 0127.28  
 90x110  
 A SL LD FPM  
  
**81-26244-10** **N**  
 0236.21  
 36x50  
 A RD ACM  

1.8 XU7JP (LFW) 73 kW (99 PS) 806 07/95-08/02

**02-25415-06**  
  
  

**08-25918-03**  
  
  







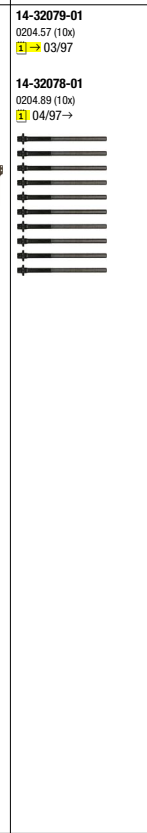

**61-25415-30**  
 0209.E1  
 84 Ø  
 1,3 mm  
  
**61-25415-40**  
 0209.L3  
 84 Ø  
 1,5 mm  

**14-32079-01**  
 0204.57 (10x)  
 03/97  
  
**14-32078-01**  
 0204.89 (10x)  
 04/97 →  







**71-26237-00**  
 0249.48  



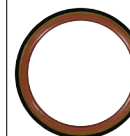

**12-25837-01**  
 0956.22 (8x)  
  
**70-25837-00**  
 0956.22  

**71-33663-00**  2x  
 0348.F6  
  
**71-26236-10**  4x  
 0349.70  
 8x 

**71-25918-30**  
 0304.34  

**81-25926-10**   
 0326.12  
 42x62  
 A RD FPM  
  
**81-34456-00**   
 0127.28  
 90x110  
 A SL LD FPM  
  
**81-26244-10** **N**  
 0236.21  
 36x50  
 A RD ACM  

**PEUGEOT**

Ltr.  1.8 XU7JP (LFZ)  74 kW (101 PS) 306  03/94-04/02 **1**

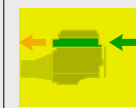

02-25415-05  
0197.G4



08-25918-05

61-25415-30  
0209.E1  
84 Ø  
1,3 mm

61-25415-40  
0209.L3  
84 Ø  
1,5 mm



14-32079-01  
0204.57 (10x)  
I ⇒ 03/97

14-32078-01  
0204.89 (10x)



71-33664-00  
0249.71



12-25837-01  
0956.22 (8x)



71-33663-00 I ⇒ 2x  
0348.F6

71-33738-00 I ⇒ 2x  
0348.E6

71-35364-00 X ⇒ 8x  
1723.63



71-25918-30  
0304.34



81-25926-10 K ⇒  
0326.12  
42x62  
A RD FPM

81-34456-00 K ⇒  
0127.28  
90x110  
A SL LD FPM



81-26244-10 N  
0236.21  
36x50  
A RD ACM



1.8 XU7JP (LFZ) 74 kW (101 PS) 405 08/92-10/96

02-25415-05  
0197.G4



08-25918-05

61-25415-30  
0209.E1  
84 Ø  
1,3 mm

61-25415-40  
0209.L3  
84 Ø  
1,5 mm



14-32079-01  
0204.57 (10x)

71-33664-00  
0249.71



12-25837-01  
0956.22 (8x)



71-33663-00 I ⇒ 2x  
0348.F6

71-33738-00 I ⇒ 2x  
0348.E6

71-35364-00 X ⇒ 8x  
1723.63



71-25918-30  
0304.34



81-25926-10 K ⇒  
0326.12  
42x62  
A RD FPM



81-34456-00 K ⇒  
0127.28  
90x110  
A SL LD FPM





















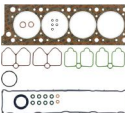











81-26244-10 N  
0236.21  
36x50  
A RD ACM





PEUGEOT

Ltr.  1.8 XU7JP (LFZ)  74-75 kW (101-102 PS) 306  03/97-04/02

										
	<p><b>02-25415-05</b> 0197.G4</p> 	<p><b>08-25918-05</b></p> 		<p><b>61-25415-30</b> 0209.E1 84 Ø 1,3 mm</p> <p><b>61-25415-40</b> 0209.L3 84 Ø 1,5 mm</p> 	<p><b>14-32078-01</b> 0204.89 (10x)</p> 	<p><b>71-33664-00</b> 0249.71</p> 	<p><b>12-25837-01</b> 0956.22 (8x)</p>  <p><b>70-25837-00</b> 0956.22</p> 	<p><b>71-33663-00</b>  2x 0348.F6</p>  <p><b>71-33738-00</b>   2x 0348.E6</p>  <p><b>71-35364-00</b>   8x 1723.E3</p> 	<p><b>71-25918-30</b> 0304.34</p> 	<p><b>81-25926-10</b>  0326.12 42x62 A RD FPM</p>  <p><b>81-34456-00</b>  0127.28 90x110 A SL LD FPM</p>  <p><b>81-26244-10</b> <b>N</b> 0236.21 36x50 A RD ACM</p> 

PEUGEOT

Ltr.  1.8 XU7JP4 (LFY) 76-86 kW (103-117 PS) 306 306 16V 406 406 16V 11/95-10/03 

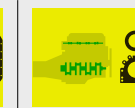
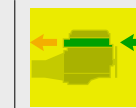

**01-35040-01**  
0197.V5  
+0209.Q3  
+0249.A2  
+0249.A3  
→ 07965



**01-35040-02**  
0197.X7  
+0209.Q3  
+0249.A2  
+0249.A3  
→ 07966→



**02-35040-01**  
→ 07965

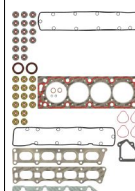

**02-35040-02**  
→ 07966→

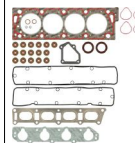

**61-35040-00**  
0209.Q3  
84 Ø

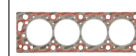

**14-32155-01**  
0204.80 (16x)

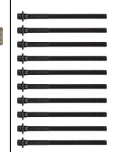

**71-34446-00 R**  
0249.A3



**71-34447-00 L**  
0249.A2





**12-35257-01**  
0956.34 (16x)  
→ 07363



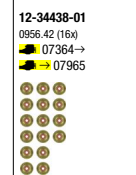

**12-34438-01**  
0956.42 (16x)  
→ 07364→  
→ 07965





**71-33666-00**    
0348.C8  
→ 07037





**71-35899-00**  4x  
0348.K6  
→ 07038→



**71-34443-00**   
0349.F4  
→ 07664





**71-35768-00**   
0349.H0  
→ 07665→



**70-31414-10**





**81-25826-10**   
0326.12  
42x62  
A RD FPM

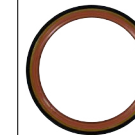

**81-34456-00**   
0127.28  
90x110  
A SL LD FPM



**81-34403-00**  2x  
0236.44  
36x50  
A SL FPM





PEUGEOT

Ltr. 1.8 6HZ (4N13) 110 kW (150 PS) 4008 05/12

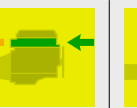
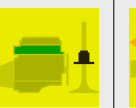
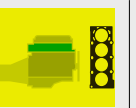

**01-54168-01**  
16 076 040 80

**61-54100-00**  
16 075 923 80  
84,5 Ø  
1,3 mm  
MLS



**61-54100-10**  
16 075 922 80  
84,5 Ø  
1,35 mm  
MLS



**61-54100-20**  
16 075 924 80  
84,5 Ø  
1,4 mm  
MLS

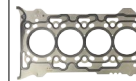

**14-13365-01**  
16 075 986 80 (10X)

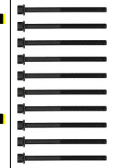

**71-54168-00**  
16 075 920 80

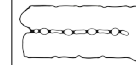

**12-54169-01**  
16 081 661 80 (8x)  
+16 081 663 80 (8x)

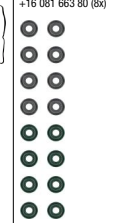

**70-54169-00 ES** 8x  
16 081 663 80



**70-54171-00 AS** 8x  
16 081 661 80



**71-54172-00**   
16 075 917 80

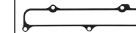

**71-54173-00**   
16 075 910 80



**70-31414-10**



**81-54174-00**   
16 075 931 80  
70x85  
A SL RD FPM



**81-54176-00**   
16 075 933 80  
95x111  
A SL LD FPM



1.8 6HZ (4N13) 110 kW (150 PS) 4008 HDI 05/12



**01-54168-01**  
16 076 040 80



**04-10301-01**   
16 075 923 80  
84,5 Ø  
1,3 mm  
MLS

**61-54100-00**  
16 075 923 80  
84,5 Ø  
1,3 mm  
MLS



**61-54100-10**  
16 075 922 80  
84,5 Ø  
1,35 mm  
MLS



**61-54100-20**  
16 075 924 80  
84,5 Ø  
1,4 mm  
MLS



**14-13365-01**  
16 075 986 80 (10X)

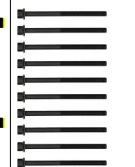

**71-54168-00**  
16 075 920 80

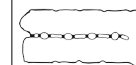

**12-54169-01**  
16 081 661 80 (8x)  
+16 081 663 80 (8x)

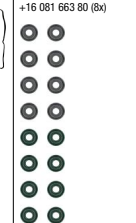

**70-54169-00 ES** 8x  
16 081 663 80



**70-54171-00 AS** 8x  
16 081 661 80



**71-54172-00**   
16 075 917 80

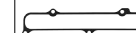

**71-54173-00**   
16 075 910 80



**70-31414-10**





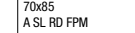



















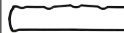

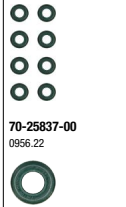















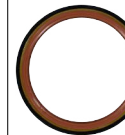











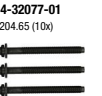

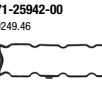

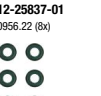







**81-54174-00**   
16 075 931 80  
70x85  
A SL RD FPM



**81-54176-00**   
16 075 933 80  
95x111  
A SL LD FPM

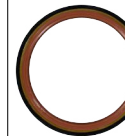

PEUGEOT

<p>Ltr.  1,9 DFV (XU9J2) XU9J2 (D6A)</p> <p>80-93 kW (109-126 PS)</p> <p>405</p> <p>07/87-12/95</p>	<p></p> <p>15-25415-04</p> 	<p></p> <p>02-25415-03</p> <p>0197.H6 +0209.E1</p>  <p>02-26237-01</p> <p>0197.H6</p> 	<p></p> <p>08-25918-05</p> 	<p></p>	<p></p> <p>61-25415-30</p> <p>0209.E1 84 Ø 1,3 mm</p> <p>61-25415-40</p> <p>0209.L3 84 Ø 1,5 mm</p> 	<p></p> <p>14-32079-01</p> <p>0204.57 (10x)</p>	<p></p> <p>71-26237-00</p> <p>0249.48</p> 	<p></p> <p>12-25837-01</p> <p>0956.22 (8x)</p>  <p>70-25837-00</p> <p>0956.22</p> 	<p></p> <p>71-31379-10 </p> <p>0348.76</p>  <p>71-26236-10 </p> <p>0349.70</p> <p>4x</p> <p>50-92244-00 </p> <p>1721.01</p>  	<p></p> <p>71-25918-30 </p> <p>0304.34</p> 	<p></p> <p>81-25926-10 </p> <p>0326.12 42x62 A RD FPM</p>  <p>81-34456-00 </p> <p>0127.28 90x110 A SL LD FPM</p>  <p>81-34403-00 </p> <p>0236.44 36x50 A SL FPM</p> 
<p>1,9 DJZ (XUD9) XUD9 XUD9 (DJZ) XUD9 (16Z)</p> <p>47-51 kW (64-69 PS)</p> <p>J5 PARTNER COMBISPACE D 205 205 D 305 D 306 306 D 306 SLD 306 STD 309 D 405 D</p> <p>10/82-05/01</p>	<p></p> <p>02-25942-03</p> <p>0197.37</p>  <p>02-25942-04</p> <p>0197.37 +0956.22 (8x)</p> 	<p></p> <p>08-25918-02</p> 	<p></p>	<p></p>	<p></p> <p>61-29165-10</p> <p>0209.K0 84 Ø 1,6 mm</p> <p>61-29165-20</p> <p>0209.K1 84 Ø 1,7 mm</p>  <p>61-31065-00</p> <p>0209.S5 84 Ø 1,4 mm</p> <p>61-31065-10</p> <p>0209.S6 84 Ø 1,45 mm</p> <p>61-31065-20</p> <p>0209.S7 84 Ø 1,5 mm</p> <p>61-31065-30</p> <p>0209.S8 84 Ø 1,55 mm</p> <p>61-31065-40</p> <p>0209.S9 84 Ø 1,6 mm</p> 	<p></p> <p>14-32077-01</p> <p>0204.65 (10x)</p> 	<p></p> <p>71-25942-00</p> <p>0249.46</p> 	<p></p> <p>12-25837-01</p> <p>0956.22 (8x)</p>  <p>70-25837-00</p> <p>0956.22</p> 	<p></p> <p>71-33156-00 </p> <p>0348.98</p>  <p>71-33157-00 </p> <p>0348.99</p> <p>2x</p> <p>71-25919-30 </p> <p>0349.47</p> <p>2x</p> <p>50-92244-00 </p> <p>1721.01</p>  	<p></p> <p>71-25918-30</p> <p>0304.34</p> 	<p></p> <p>81-25926-10 </p> <p>0326.12 42x62 A RD FPM</p>  <p>81-34456-00 </p> <p>0127.28 90x110 A SL LD FPM</p>  <p>81-21798-30 </p> <p>0236.14 35x50 A SL WD ACM</p> 

PEUGEOT

Ltr.  1,9 DW8 (WJZ)  
DW8B (WJY)

51-52 kW (69-71 PS)

EXPERT D  
PARTNER D  
206 D  
207  
306 D

06/96-12/15 



**01-34356-01**  
0197.X6  
+0127.28  
+0326.22  
+0807.14

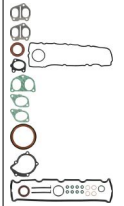

**02-34356-01**  
0197.X5  
+0807.14



**61-33720-00**  
0209.X0  
84 Ø  
1,26 mm  
MLS

**61-33720-10**  
0209.X1  
84 Ø  
1,3 mm  
MLS

**61-33720-20**  
0209.X2  
84 Ø  
1,34 mm  
MLS

**61-33720-30**  
0209.X3  
84 Ø  
1,38 mm  
MLS

**61-33720-40**  
0209.X4  
84 Ø  
1,42 mm  
MLS

**61-33720-50**  
0209.1C  
84 Ø  
1,47 mm  
MLS





**14-32077-01**  
0204.65 (10x)  
→ 08469



**15-34356-01**  
0249.95  
+0249.97

**71-34353-00 U**  
0249.97

**71-34356-00 O**  
0249.95



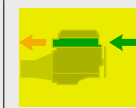

**12-25837-01**  
0956.22 (8x)

**70-25837-00**  
0956.22

**71-34987-00 I**  2x  
0348.N8

**71-34988-00 I**  2x  
0348.P0

**71-29465-00**  2x  
0349.H7



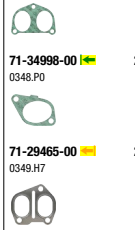

**71-25918-30**  
0304.34





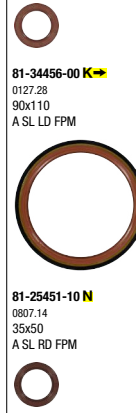

**81-25926-10 K**   
0326.12  
42x62  
A RD FPM

**81-34456-00 K**   
0127.28  
90x110  
A SL LD FPM

**81-25451-10 N**  
0807.14  
35x50  
A SL RD FPM



PEUGEOT

Ltr.    1

1,9 D2H (XU92C) 70-96 kW (95-131 PS) 205 06/87-09/98  
 D5A (XU92C) 205 CTI  
 XU9JA (D6B) 205 GTI  
 XU9JAZ (DKZ) 309  
 XU9J1 (DFZ) 309 GTI  
 XU9M (DDZ) 405  
 XU92C (D2A)  
 XU92C (D2C)

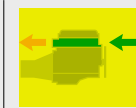

**02-25415-03**  
 0197.H6  
 +0209.E1



**08-25918-05**



**61-25415-30**  
 0209.E1  
 84 Ø  
 1,3 mm

**61-25415-40**  
 0209.L3  
 84 Ø  
 1,5 mm



**14-32079-01**  
 0204.57 (10x)

**71-26237-00**  
 0249.48





**12-25837-01**  
 0956.22 (8x)





**70-25837-00**  
 0956.22





**71-31379-10**    
 0348.76



**71-26236-10**  4x  
 0349.70



**71-27178-10**    
 1710.39



**71-25918-30**  
 0304.34



























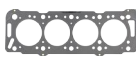
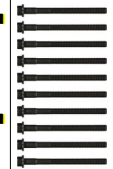























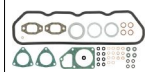



























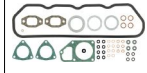











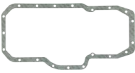





**81-25926-10**   
 0326.12  
 42x62  
 A RD FPM



**81-34456-00**   
 0127.28  
 90x110  
 A SL LD FPM



PEUGEOT

<p>Ltr. </p>	<p>1,9 D8A (XUD9TE) XUD9BSD (D8V) XUD9TE XUD9TE (DHX) XUD9TE (DHY) XUD9UTF (D8C) 42 D</p>	<p>55-69 kW (75-94 PS)</p>	<p>BOXER BOXER Bus TD BOXER TD EXPERT D 306 D 306 DT 306 SRDT 306 TD 405 TD 406 D 406 TD 806</p>	<p>08/92-10/04</p>											
<p>1,9</p>	<p>D8A (XUD9TE) XUD9BSD (D8V) XUD9TE XUD9TE (DHX) XUD9TE (DHY) XUD9UTF (D8C) 42 D</p>	<p>55-69 kW (75-94 PS)</p>	<p>BOXER BOXER Bus TD BOXER TD EXPERT D 306 D 306 DT 306 SRDT 306 TD 405 TD 406 D 406 TD 806</p>	<p>08/92-10/04</p>	<p>02-25942-06 </p>	<p>08-25918-02 </p>	<p>61-33155-00 0209.08 84 Ø 1,36 mm MLS</p> <p>61-33155-10 0209.09 84 Ø 1,4 mm MLS</p> <p>61-33155-20 0209.R0 84 Ø 1,44 mm MLS</p> <p>61-33155-30 0209.R1 84 Ø 1,48 mm MLS</p> <p>61-33155-40 0209.R2 84 Ø 1,53 mm MLS</p> <p>61-33155-50 0209.T7 84 Ø 1,59 mm MLS</p> <p>61-33155-60 84 Ø 1,7 mm MLS</p> 	<p>14-32177-01 0204.73 (10x)</p> 	<p>71-25942-00 0249.46</p> 	<p>12-25837-01 0956.22 (8x)</p> 	<p>71-33683-00   0348.J0</p>  <p>50-92244-00   1721.01</p>  <p>8x</p>	<p>71-25918-30 0304.34</p> 	<p>81-25826-10  0326.12 42x62 A RD FPM</p>  <p>81-34456-00  0127.28 90x110 A SL LD FPM</p>  <p>81-21798-30  0236.14 35x50 A SL WD ACM</p> 	<p>81-27333-00  0514.11 42x60 A RD ACM</p>  <p>71-25853-10  0119.03 4586484→</p> 	<p>81-27333-00  0514.11 42x60 A RD ACM</p>  <p>71-25853-10  0119.03</p> 
<p>1,9</p>	<p>XDP88</p>	<p>40 kW (55 PS)</p>	<p>J7 Bus D J7 D</p>	<p>08/68-07/78</p>	<p>02-50919-10 0197.08 4586484→</p> 	<p>08-25857-01 4586484→</p> 	<p>61-23635-10 0203.70 94 Ø 1,5 mm 4586484→</p> <p>61-23635-20 79 32 566 274 94 Ø 1,8 mm 4586484→</p> 	<p>71-50919-10 0249.25 4586484→</p> 	<p>12-77023-01 0956.01 (8x) 4586484→</p>  <p>40-77023-00 0956.01 4586484→</p> 	<p>71-50920-10  0349.08 4586484→</p>  <p>71-24581-10   1710.19 4586484→</p>  <p>8x</p>	<p>71-25857-10 0313.19 4586484→</p> 	<p>81-27333-00  0514.11 42x60 A RD ACM</p>  <p>71-25853-10  0119.03 4586484→</p> 	<p>81-27333-00  0514.11 42x60 A RD ACM</p>  <p>71-25853-10  0119.03</p> 	<p>81-27333-00  0514.11 42x60 A RD ACM</p>  <p>71-25853-10  0119.03</p> 	<p>81-27333-00  0514.11 42x60 A RD ACM</p>  <p>71-25853-10  0119.03</p> 
<p>1,9</p>	<p>XD4X88</p>	<p>40-41 kW (54-56 PS)</p>	<p>504 504 D</p>	<p>03/73-12/89</p>	<p>02-50919-10 0197.08</p> 	<p>08-25857-01</p> 	<p>61-23635-10 0203.70 94 Ø 1,5 mm</p> <p>61-23635-20 79 32 566 274 94 Ø 1,8 mm</p> 	<p>71-50919-10 0249.25</p> 	<p>12-77023-01 0956.01 (8x)</p>  <p>40-00948-00   1710.07</p>  <p>8x</p>	<p>71-50920-10  0349.08</p>  <p>40-00948-00   1710.07</p>  <p>8x</p>	<p>71-25857-10 0313.19</p> 	<p>81-27333-00  0514.11 42x60 A RD ACM</p>  <p>71-25853-10  0119.03</p> 	<p>81-27333-00  0514.11 42x60 A RD ACM</p>  <p>71-25853-10  0119.03</p> 	<p>81-27333-00  0514.11 42x60 A RD ACM</p>  <p>71-25853-10  0119.03</p> 	<p>81-27333-00  0514.11 42x60 A RD ACM</p>  <p>71-25853-10  0119.03</p> 

PEUGEOT

Ltr.  1,9 XUD9 (D9A) 47 kW (64 PS) 305 D 309 D  10/82-12/93

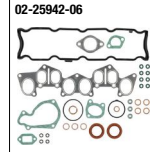
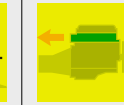

02-25942-06



08-25918-02

61-29165-10  
0209.K0  
84 Ø  
1,6 mm



61-29165-20  
0209.K1  
84 Ø  
1,7 mm



61-31065-00  
0209.S5  
84 Ø  
1,4 mm

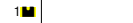

61-31065-10  
0209.S6  
84 Ø  
1,45 mm



61-31065-20  
0209.S7  
84 Ø  
1,5 mm



61-31065-30  
0209.S8  
84 Ø  
1,55 mm



61-31065-40  
0209.S9  
84 Ø  
1,6 mm



14-32077-01  
0204.65 (10x)



71-25942-00  
0249.46

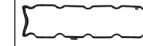

12-25837-01  
0956.22 (8x)



71-33683-00    
0348.J0



50-92244-00    
1721.01



8x

71-25918-30  
0304.34

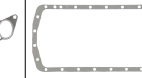

81-25926-10    
0326.12  
42x62  
A RD FPM



81-34456-00    
0127.28  
90x110  
A SL LD FPM

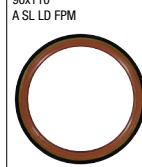

81-21798-30    
0236.14  
35x50  
A SL WD ACM



PEUGEOT

Ltr.  1.9 XUD9A (DJY)  
XUD9A (D9B)  
XUD9AU (D8C) 47-52 kW (64-71 PS)  BOXER Bus D  
BOXER D  
EXPERT D  
J5  
J5 Bus D  
J5 D  
PARTNER D  
205 D  
306 D  
306 SLD  
306 STD  
306 TD  
309 D  
405 D 09/87 

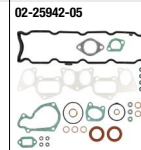
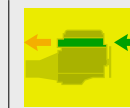

**61-29165-10**  
0209.K0  
84 Ø  
1,6 mm



**61-29165-20**  
0209.K1  
84 Ø  
1,7 mm



**61-31065-00**  
0209.S5  
84 Ø  
1,4 mm



**61-31065-10**  
0209.S6  
84 Ø  
1,45 mm



**61-31065-20**  
0209.S7  
84 Ø  
1,5 mm



**61-31065-30**  
0209.S8  
84 Ø  
1,55 mm

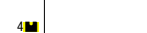

**61-31065-40**  
0209.S9  
84 Ø  
1,6 mm



**14-32077-01**  
0204.65 (10x)

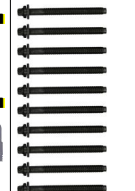

**71-25942-00**  
0249.46



**12-25837-01**  
0956.22 (8x)





**70-25837-00**  
0956.22

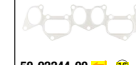

8x

**71-33682-00**    
0348.89



**50-92244-00**    
1721.01



**71-25918-30**  
0304.34



**81-25926-10**   
0326.12  
42x62  
A RD FPM



**81-34456-00**   
0127.28  
90x110  
A SL LD FPM

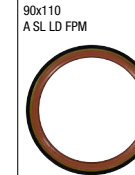























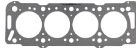

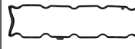





**81-21798-30**   
0236.14  
35x50  
A SL WD ACM





PEUGEOT

Ltr.  1,9 XUD9TE (DHX) 66-69 kW (90-94 PS) EXPERT TD 406 TD 806 TD  
 07/95-08/02

										
	<p><b>02-25942-06</b></p> 	<p><b>08-25918-02</b></p> 	<p><b>04-10241-01</b> </p> 	<p><b>61-33155-00</b> 0209.08 84 Ø 1,36 mm MLS</p> <p><b>61-33155-10</b> 0209.09 84 Ø 1,4 mm MLS</p> <p><b>61-33155-20</b> 0209.R0 84 Ø 1,44 mm MLS</p> <p><b>61-33155-30</b> 0209.R1 84 Ø 1,48 mm MLS</p> <p><b>61-33155-40</b> 0209.R2 84 Ø 1,53 mm MLS</p> <p><b>61-33155-50</b> 0209.T7 84 Ø 1,59 mm MLS</p> <p><b>61-33155-60</b> 84 Ø 1,7 mm MLS</p> 	<p><b>14-32177-01</b> 0204.73 (10x)</p> 	<p><b>71-25942-00</b> 0249.46</p> 	<p><b>12-25837-01</b> 0956.22 (8x)</p> 	<p><b>71-33683-00</b>  </p> <p>0348.J0</p>  <p><b>50-92244-00</b>  </p> <p>1721.01</p>  <p>8x</p>	<p><b>71-25918-30</b> 0304.34</p> 	<p><b>81-25926-10</b> </p> <p>0326.12 42x62 A RD FPM</p>  <p><b>81-34456-00</b> </p> <p>0127.28 90x110 A SL LD FPM</p>  <p><b>81-21798-30</b> </p> <p>0236.14 35x50 A SL WD ACM</p> 



**PEUGEOT**

Ltr.   

1,9 XU9JA (D6B) 72-94 kW (98-128 PS) 205  
 XU9J1 (DFZ) 205 GTI  
 XU9S (D2B) 305  
 XU9S (159) 309  
 309 GTI

09/84-07/89 **1**

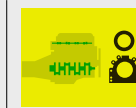
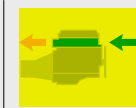

1,9	XU9JA (D6B) XU9J1 (DFZ) XU9S (D2B) XU9S (159)	72-94 kW (98-128 PS)	205 205 GTI 305 309 309 GTI	09/84-07/89	<b>1</b>
-----	--	----------------------	---	-------------	----------

**02-25415-03**  
 0197.H6  
 +0209.E1



**02-25415-08**  
 0197.H6  
 +0209.L3

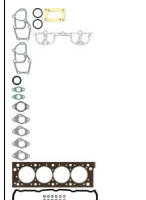

**02-26237-01**  
 0197.H6

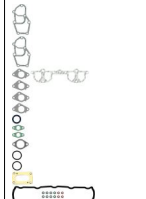

**08-25918-05**



**61-25415-30**  
 0209.E1  
 84 Ø  
 1,3 mm



**61-25415-40**  
 0209.L3  
 84 Ø  
 1,5 mm



**14-32078-01**  
 0204.89 (10x)  
 ⇒ 03/87



**14-32079-01**  
 0204.57 (10x)  
 04/87 →



**71-26237-00**  
 0249.48



**12-25837-01**  
 0956.22 (8x)



**70-25837-00**  
 0956.22



**71-31379-10**    
 0348.76



**71-26236-10**  4x  
 0349.70



**71-27178-10**     
 1710.39



**71-25918-30**  
 0304.34



**81-25826-10**   
 0326.12  
 42x62  
 A RD FPM



**81-34456-00**   
 0127.28  
 90x110  
 A SL LD FPM



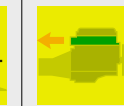

PEUGEOT

Ltr.  1.9 XU9JA (D6B) 96 kW (131 PS) 309  10/85-08/89

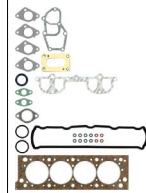

**02-25415-03**

0197.H6  
+0209.E1



**02-25415-08**

0197.H6  
+0209.L3

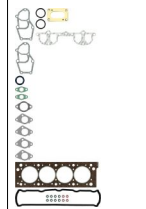

**02-26237-01**

0197.H6

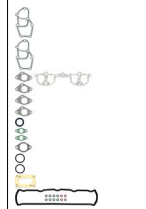

**08-25918-05**



**61-25415-30**

0209.E1  
84 Ø  
1,3 mm

**61-25415-40**

0209.L3  
84 Ø  
1,5 mm



**14-32078-01**

0204.89 (10x)  
⇒ 03/87

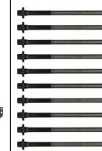

**14-32079-01**

0204.57 (10x)

**71-26237-00**

0249.48



**12-25837-01**

0956.22 (8x)



**70-25837-00**

0956.22



**71-31379-10**

0348.76



**71-26236-10**

0349.70



**71-27178-10**

1710.39



**71-25918-30**

0304.34

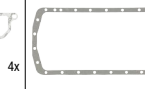

**81-25826-10**

0326.12

42x62  
A RD FPM



**81-34456-00**

0127.28





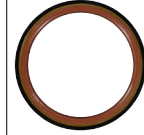





























90x110

A SL LD FPM

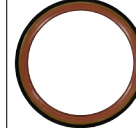















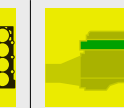

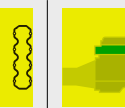
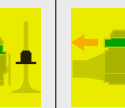
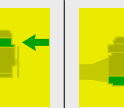





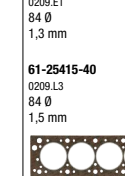
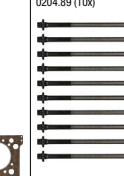
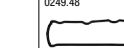
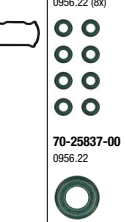

**PEUGEOT**

Ltr.  1.9 XU9J4 (D6C) 108-116 kW (147-158 PS) 205 06/87-12/93  
 XU9J4Z (DFW) 309 GTI 16V 405



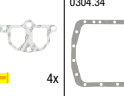







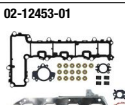
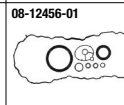

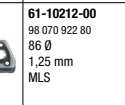
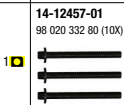
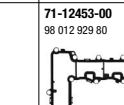
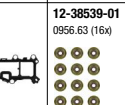

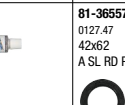
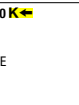

										
	<p><b>02-25415-07</b> 0197.J2 +0209.L3</p>  <p><b>02-33668-01</b> 0197.J2</p> 	<p><b>08-25918-05</b></p> 		<p><b>61-25415-40</b> 0209.L3 84 Ø 1,5 mm</p> 	<p><b>14-32079-01</b> 0204.57 (10x)</p>	<p><b>71-33668-00</b> 0249.74</p> 	<p><b>12-26058-03</b> 0956.19 (16x)</p>  <p><b>70-26058-00</b> 0956.19 16x</p> 	<p><b>71-33684-00</b>  2x 0348.G4</p>  <p><b>71-33686-00</b>  0349.E8</p> 	<p><b>71-25918-30</b> 0304.34</p> 	<p><b>81-25926-10</b>  <b>K</b> </p> <p>0326.12 42x62 A RD FPM</p>  <p><b>81-34456-00</b>  <b>K</b> </p> <p>0127.28 90x110 A SL LD FPM</p>  <p><b>81-26244-10</b>  <b>N</b>  2x</p> <p>0236.21 36x50 A RD ACM</p>  <p><b>81-22660-00</b>  <b>N</b>  2x</p> <p>0236.24 32x45 A LD FPM</p> 

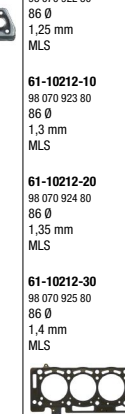
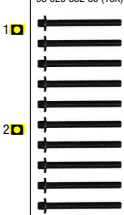
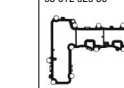
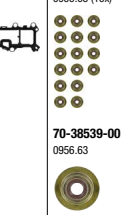
PEUGEOT

Ltr.  1,9 XU9S (159) 75 kW (102 PS) 305  10/82-08/85





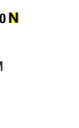







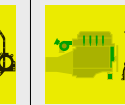
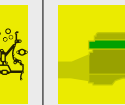
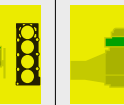

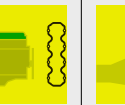
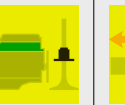
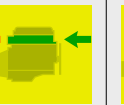

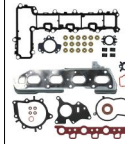





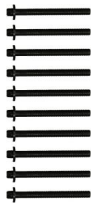
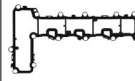

											
	<p><b>02-25415-03</b> 0197.H6 +0209.E1</p>  <p><b>02-25415-08</b> 0197.H6 +0209.L3</p>  <p><b>02-26237-01</b> 0197.H6</p> 	<p><b>08-25918-05</b></p> 		<p><b>61-25415-30</b> 0209.E1 84 Ø 1,3 mm</p> <p><b>61-25415-40</b> 0209.L3 84 Ø 1,5 mm</p> 	<p><b>14-32078-01</b> 0204.89 (10x)</p> 	<p><b>71-26237-00</b> 0249.48</p> 	<p><b>12-25837-01</b> 0956.22 (8x)</p> <p><b>70-25837-00</b> 0956.22</p> 	<p><b>71-31379-10</b> </p> <p>0348.76</p>  <p><b>71-26236-10</b>  4x</p> <p>0349.70</p>  <p><b>71-27178-10</b>  </p> <p>1710.39</p> 	<p><b>71-25918-30</b> 0304.34</p> 	<p><b>81-25826-10</b> </p> <p>0326.12 42x62 A RD FPM</p>  <p><b>81-34456-00</b> </p> <p>0127.28 90x110 A SL LD FPM</p> 	

2,0 AHH (DW10FC) 90-133 kW (122-181 PS) EXPERT 06/09  
 AHJ (DW10FE) EXPERT HDI  
 AHK (DW10FE) EXPERT HDI 120  
 AHR (DW10FD) EXPERT HDI 150  
 AHS (DW10FD) EXPERT HDI 180  
 AHV (DW10FD) TRAVELLER HDI  
 AHW (DW10FC) TRAVELLER HDI 145  
 AHX (DW10FCD) TRAVELLER HDI 150  
 AHX (DW10FD) TRAVELLER HDI 180  
 EHS (DW10FDDU370) 3008 HDI  
 EHT (DW10FDDU340) 308 HDI  
 EHY (DW10FCC) 308 HDI 150  
 EHZ (DW10FDCU) 308 HDI 180  
 5008 HDI  
 5008 HDI 150  
 508 HDI  
 508 HDI 150  
 508 HDI 180











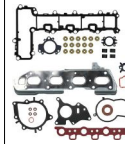







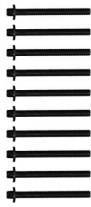
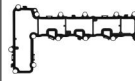

											
	<p><b>02-12453-01</b></p> 	<p><b>08-12456-01</b></p> 	<p><b>04-10350-01</b> </p> 	<p><b>61-10212-00</b> 98 070 922 80 86 Ø 1,25 mm MLS</p> <p><b>61-10212-10</b> 98 070 923 80 86 Ø 1,3 mm MLS</p> <p><b>61-10212-20</b> 98 070 924 80 86 Ø 1,35 mm MLS</p> <p><b>61-10212-30</b> 98 070 925 80 86 Ø 1,4 mm MLS</p> 	<p><b>14-12457-01</b> 98 020 332 80 (10x)</p> 	<p><b>71-12453-00</b> 98 012 929 80</p> 	<p><b>12-38539-01</b> 0956.63 (16x)</p> <p><b>70-38539-00</b> 0956.63</p> 	<p><b>71-12456-00</b> </p> <p>98 009 431 80</p>  <p><b>71-12456-00</b> 98 014 448 80</p> 	<p><b>81-36557-00</b> </p> <p>0127.47 42x62 A SL RD PTFE</p>  <p><b>81-36556-00</b> </p> <p>0127.45 90x110 A SL LD PTFE</p>  <p><b>81-34144-00</b> <b>N</b></p> <p>0807.28 27x47 A SL RD FPM</p> 		

PEUGEOT





















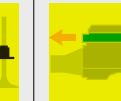

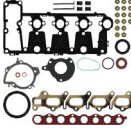
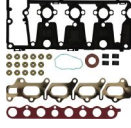

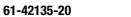









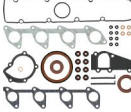
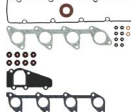





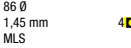

Ltr.  2,0 AHM (DW10FUE) 81 kW (110 PS) BOXER HDI BOXER HDI 110  07/15-09/19

											
	02-12453-01 	08-12456-01 		61-10212-00 98 070 922 80 86 Ø 1,25 mm MLS  61-10212-10 98 070 923 80 86 Ø 1,3 mm MLS  61-10212-20 98 070 924 80 86 Ø 1,35 mm MLS  61-10212-30 98 070 925 80 86 Ø 1,4 mm MLS  	14-12457-01 98 020 332 80 (10x) 	71-12453-00 98 012 929 80 	12-38539-01 0956.63 (16x)  70-38539-00 0956.63 16x 	71-12455-00  98 009 431 80 	70-31414-10  71-12456-00 98 014 448 80 	81-36557-00  0127.47 42x62 A SL RD PTFE  81-36556-00  0127.45 90x110 A SL LD PTFE  81-34144-00 <b>N</b> 0807.28 27x47 A SL RD FPM 	



2,0 AHN (DW10FUD) 96-120 kW (130-163 PS) BOXER BOXER HDI BOXER HDI 130 BOXER HDI 160 07/15

	02-12453-01 	08-36556-01  		61-10212-00 98 070 922 80 86 Ø 1,25 mm MLS  61-10212-10 98 070 923 80 86 Ø 1,3 mm MLS  61-10212-20 98 070 924 80 86 Ø 1,35 mm MLS  61-10212-30 98 070 925 80 86 Ø 1,4 mm MLS  	14-12457-01 98 020 332 80 (10x) 	71-12453-00 98 012 929 80 	12-38539-01 0956.63 (16x)  70-38539-00 0956.63 16x 	71-12455-00  98 009 431 80 	70-31414-10  	81-36557-00  0127.47 42x62 A SL RD PTFE  81-36556-00  0127.45 90x110 A SL LD PTFE  81-34144-00 <b>N</b> 0807.28 27x47 A SL RD FPM 
--	--	---	--	---	---	---	--	---	---	---

PEUGEOT

Ltr.														
2,0	AHY (DW10CE) AHZ (DW10CD) DW10CTED4 (RHH) RHA (DW10CTED4) RHC (DW10CTED4) RHD (DW10CB) RHD (DW10CTED4) RHE (DW10CTED4) RHR (DW10CB)	72-147 kW (98-200 PS)	06/06	<b>01-42135-01</b> 0197.AW +0249.G8 +0348.V7 	<b>02-42135-01</b> 0197.AX +0348.V7 			<b>61-42135-00</b> 0209.GL 1,25 mm MLS  <b>61-42135-10</b> 0209.GN 1,3 mm MLS  <b>61-42135-20</b> 0209.GP 1,35 mm MLS  <b>61-42135-30</b> 0209.GQ 1,4 mm MLS 	<b>14-35774-01</b> 0204.A6 (10x) 	<b>71-42033-00</b> 0348.V7 	<b>12-38539-01</b> 0956.63 (16x)  <b>70-38539-00</b> 0956.63 	<b>71-42032-00</b> 0349.N2 	<b>70-31414-10</b> 	<b>81-36557-00 K</b> 0127.47 42x62 A SL RD PTFE  <b>81-36556-00 K</b> 0127.45 90x110 A SL LD PTFE  <b>81-34144-00 N</b> 0807.28 27x47 A SL RD FPM 
2,0	DW10ATED (RHS) DW10ATED (RHZ) DW10TD (RHY)	66-80 kW (90-109 PS)	06/98-12/12	<b>01-34398-01</b> 0197.X4 +0249.99 	<b>02-34398-01</b> 0197.X3 +0249.99 		<b>04-10177-01</b> 	<b>61-35815-00</b> 0209.X5 86 Ø 1,3 mm MLS  <b>61-35815-10</b> 0209.X6 86 Ø 1,35 mm MLS  <b>61-35815-20</b> 0209.X7 86 Ø 1,4 mm MLS  <b>61-35815-30</b> 0209.X8 86 Ø 1,45 mm MLS  <b>61-35815-40</b> 0209.X9 86 Ø 1,5 mm MLS 	<b>14-35774-01</b> 0204.A6 (10x) 	<b>71-34398-00</b> 0249.99 	<b>12-31306-07</b> 0956.38 (8x) 08331  <b>12-34399-01</b> 0956.48 (8x) 08332→  <b>70-31306-00</b> 0956.64 08331  <b>70-34399-00</b> 0956.48 08332→ 	<b>71-34401-00</b> 0348.N4  <b>71-34402-00</b> 0349.H4 	<b>70-31414-10</b> 	<b>81-25926-10 K</b> 0326.12 42x62 A RD FPM  <b>81-34456-00 K</b> 0127.28 90x110 A SL LD FPM  <b>81-34144-00 N</b> 0807.28 27x47 A SL RD FPM 

PEUGEOT

Ltr.    1

2,0 DW10ATED4 (RHM) 79-80 kW (107-109 PS) EXPERT HDI 08/99  
 DW10ATED4 (RHT) 806 HDI 16V  
 DW10ATED4 (RHW) 807 HDI  
 807 HDI FAP



01-34404-01  
0197.Y6



02-34404-01  
0197.Y7  
+0249.A6

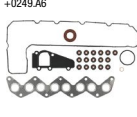

04-10074-01 



61-34370-00  
0209.AV  
86 Ø  
1,25 mm  
MLS

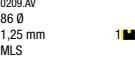

61-34370-10  
0209.AW  
86 Ø  
1,3 mm  
MLS

61-34370-20  
0209.AX  
86 Ø  
1,35 mm  
MLS

61-34370-30  
0209.AY  
86 Ø  
1,4 mm  
MLS



14-32233-01  
0204.96 (10x)



71-34404-00  
0249.A6



12-34399-02  
0956.48 (16x)

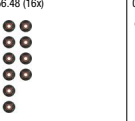

70-34399-00  
0956.48

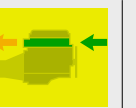

71-33223-00   
0349.J2



70-31414-10

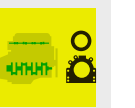

81-25926-10   
0326.12  
42x62  
A RD FPM

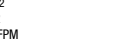

81-34456-00   
0127.28  
90x110  
A SL LD FPM



81-34144-00 **N**  
0807.28  
27x47  
A SL RD FPM





2,0 DW10BTD (RHX) 69 kW (94 PS) EXPERT HDI 07/00-12/06

01-34398-01  
0197.X4  
+0249.99

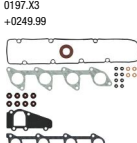

02-34398-01  
0197.X3  
+0249.99



04-10074-01 



61-35815-00  
0209.X5  
86 Ø  
1,3 mm  
MLS



61-35815-10  
0209.X6  
86 Ø  
1,35 mm  
MLS

61-35815-20  
0209.X7  
86 Ø  
1,4 mm  
MLS

61-35815-30  
0209.X8  
86 Ø  
1,45 mm  
MLS

61-35815-40  
0209.X9  
86 Ø  
1,5 mm  
MLS



14-35774-01  
0204.96 (10x)

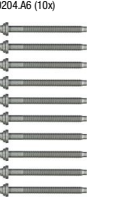

71-34398-00  
0249.99



12-31306-07  
0956.38 (8x)  
 08331

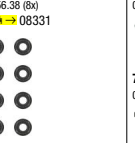

12-34399-01  
0956.48 (8x)  
 08332 →



70-31306-00  
0956.64  
 08331



70-34399-00  
0956.48  
 08332 →



71-34401-00   
0348.N4



71-34402-00   
0349.H4



70-31414-10



81-25926-10   
0326.12  
42x62  
A RD FPM









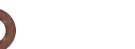







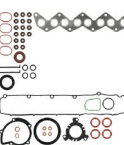

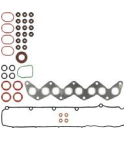









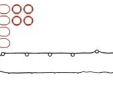



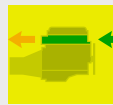









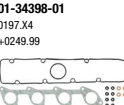

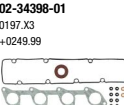





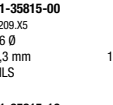



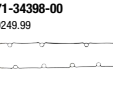

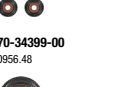

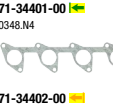

81-34456-00   
0127.28  
90x110  
A SL LD FPM



81-34144-00 **N**  
0807.28  
27x47  
A SL RD FPM

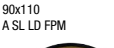

PEUGEOT

<p>Ltr.   </p> <p>2,0 DW10BTEd4 (RHR) RHL (DW10BTEd4)</p> <p>93-103 kW (126-140 PS)</p> <p>EXPERT HDI 140 EXPERT TEPEE HDI 140 307 CC HDI 135 FAP 307 HDI 307 HDI 135 FAP 307 SW HDI 135 FAP 308 CC HDI 308 HDI 407 HDI 407 HDI 135 FAP 407 SW HDI 135 FAP 508 HDI 607 HDI 807 HDI</p>	 <p><b>01-36571-01</b> 0197.AE +0348.S3</p> 	 <p><b>02-36571-01</b> 0197.AC +0348.S3</p> 		 <p><b>04-10061-01</b> </p> 	 <p><b>61-34370-00</b> 0209.AV 86 Ø 1,25 mm MLS</p> <p><b>61-34370-10</b> 0209.AW 86 Ø 1,3 mm MLS</p> <p><b>61-34370-20</b> 0209.AX 86 Ø 1,35 mm MLS</p> <p><b>61-34370-30</b> 0209.AY 86 Ø 1,4 mm MLS</p> 	 <p><b>14-35774-01</b> 0204.A6 (10x)</p> 	 <p><b>15-36571-01</b> 0348.S3</p> 	 <p><b>12-34399-02</b> 0956.48 (16x)</p>  <p><b>70-34399-00</b> 0956.48</p>  <p>16x</p>	 <p><b>71-33223-00</b>  0349.J2</p> 	 <p><b>70-31414-10</b></p> 	 <p><b>81-36557-00</b>  0127.47 42x62 A SL RD PTFE</p>  <p><b>81-36556-00</b>  0127.45 90x110 A SL LD PTFE</p>  <p><b>81-34144-00</b> <b>N</b> 0807.28 27x47 A SL RD FPM</p> 
<p>2,0 DW10UTD (RHV) RHV (DW10TD) RHZ (DW10BTED+)</p> <p>62-80 kW (84-109 PS)</p> <p>BOXER Bus HDI BOXER HDI EXPERT HDI</p> <p>07/00-12/06</p>	 <p><b>01-34398-01</b> 0197.X4 +0249.99</p> 	 <p><b>02-34398-01</b> 0197.X3 +0249.99</p> 		 <p><b>04-10177-01</b> </p> 	 <p><b>61-35815-00</b> 0209.X5 86 Ø 1,3 mm MLS</p> <p><b>61-35815-10</b> 0209.X6 86 Ø 1,35 mm MLS</p> <p><b>61-35815-20</b> 0209.X7 86 Ø 1,4 mm MLS</p> <p><b>61-35815-30</b> 0209.X8 86 Ø 1,45 mm MLS</p> <p><b>61-35815-40</b> 0209.X9 86 Ø 1,5 mm MLS</p> 	 <p><b>14-35774-01</b> 0204.A6 (10x)</p> 	 <p><b>71-34398-00</b> 0249.99</p> 	 <p><b>12-34399-01</b> 0956.48 (8x)</p>  <p><b>70-34399-00</b> 0956.48</p>  <p>8x</p>	 <p><b>71-34401-00</b>  0348.N4</p>  <p><b>71-34402-00</b>  0349.H4</p> 	 <p><b>70-31414-10</b></p> 	 <p><b>81-25926-10</b>  0326.12 42x62 A RD FPM</p>  <p><b>81-34456-00</b>  0127.28 90x110 A SL LD FPM</p>  <p><b>81-34144-00</b> <b>N</b> 0807.28 27x47 A SL RD FPM</p> 



PEUGEOT

Ltr.  2,0 DW10UTED4 (RHK) 88 kW (120 PS) EXPERT HDI  01/10

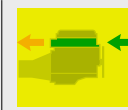

2,0 DW10UTED4 (RHK) 88 kW (120 PS) EXPERT HDI 01/10

**02-36571-02**  
0197.AN  
+0348.S3

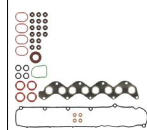

**04-10074-01** 



**61-34370-00**  
0209.AV  
86 Ø  
1,25 mm  
MLS **1** 

**61-34370-10**  
0209.AW  
86 Ø  
1,3 mm  
MLS **2** 

**61-34370-20**  
0209.AX  
86 Ø  
1,35 mm  
MLS **3** 

**61-34370-30**  
0209.AY  
86 Ø  
1,4 mm  
MLS **4** 



**14-35774-01**  
0204.A6 (10x)

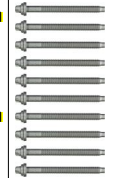

**15-36571-01**  
0348.S3

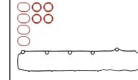

**12-34399-02**  
0956.48 (16x)



**70-34399-00**  
0956.48 16x



**71-36124-00**   
0349.L9



**70-31414-10**



**81-36557-00**   
0127.47  
42x62  
A SL RD PTFE



**81-36556-00**   
0127.45  
90x110  
A SL LD PTFE





**81-34144-00** **N**  
0807.28  
27x47  
A SL RD FPM

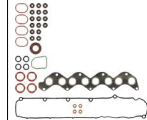

2,0 DW10UTED4 (RHK) 88 kW (120 PS) EXPERT HDI 120 EXPERT TEPEE HDI EXPERT TEPEE HDI 120 807 HDI 02/06

**02-36571-02**  
0197.AN  
+0348.S3



**61-34370-00**  
0209.AV  
86 Ø  
1,25 mm  
MLS **1** 

**61-34370-10**  
0209.AW  
86 Ø  
1,3 mm  
MLS **2** 

**61-34370-20**  
0209.AX  
86 Ø  
1,35 mm  
MLS **3** 

**61-34370-30**  
0209.AY  
86 Ø  
1,4 mm  
MLS **4** 



**14-35774-01**  
0204.A6 (10x)

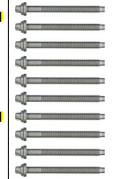

**15-36571-01**  
0348.S3

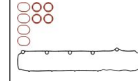



**12-34399-02**  
0956.48 (16x)



**70-34399-00**  
0956.48 16x





**71-36124-00**   
0349.L9



**70-31414-10**



**81-36557-00**   
0127.47  
42x62  
A SL RD PTFE



**81-36556-00**   
0127.45  
90x110  
A SL LD PTFE

























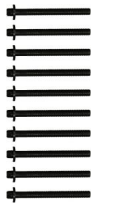

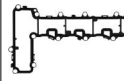

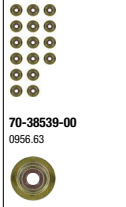









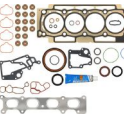
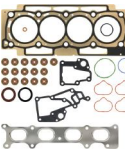

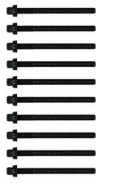

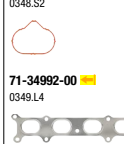

**81-34144-00** **N**  
0807.28  
27x47  
A SL RD FPM



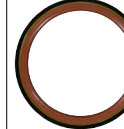











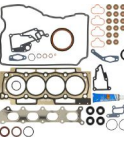

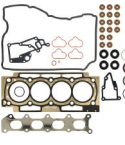



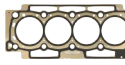







PEUGEOT

Ltr.  2,0 EHZ (DW10FC) 130 kW (177 PS) 3008 HDI 308 HDI 5008 HDI 508 HDI  06/17





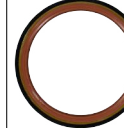





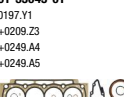
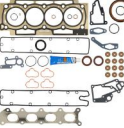

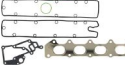



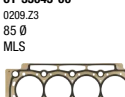

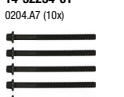

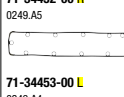







	 <p>02-12453-01</p> 	 <p>08-12456-01</p> 	 <p>04-10350-01 </p> 	 <p>61-10212-00 98 070 922 80 86 Ø 1,25 mm MLS </p> <p>61-10212-10 98 070 923 80 86 Ø 1,3 mm MLS </p> <p>61-10212-20 98 070 924 80 86 Ø 1,35 mm MLS </p> <p>61-10212-30 98 070 925 80 86 Ø 1,4 mm MLS </p> 	 <p>14-12457-01 98 020 332 80 (10x)</p> 	 <p>71-12453-00 98 012 929 80</p> 	 <p>12-38539-01 0956.63 (16x)</p> <p>70-38539-00 0956.63 16x</p> 	 <p>71-12455-00 </p> <p>98 009 431 80</p> 	 <p>71-12456-00 98 014 448 80</p> 	 <p>81-36557-00 </p> <p>0127.47 42x62 A SL RD PTFE</p>  <p>81-36556-00 </p> <p>0127.45 90x110 A SL LD PTFE</p> 
<p>2,0 EW10 (RFH) EW10A (RFJ)</p> <p>102-111 kW (139-151 PS)</p> <p>EXPERT TEPEE 16V EXPERT 16V 307 307 CC 16V 307 SW 16V 307 16V 308 407 407 SW 16V 407 16V 408 807 16V</p> <p>03/04</p>	<p>01-37360-01</p> 	<p>02-37360-01</p> 	<p>08-41188-01</p> 	<p>61-37360-00 0209.FS MLS</p> 	<p>14-32342-01 0204.A3 (10x)</p> 	 <p>12-34439-01 0956.45 (16x)</p> <p>70-34439-00 0956.45 16x</p> 	<p>71-38549-00 </p> <p>0348.S2 4x</p> <p>71-34992-00 </p> <p>0349.L4</p> 	<p>70-31414-10</p> 	<p>81-34454-10 </p> <p>16 089 406 80 40x55 A SL RD PTFE</p>  <p>81-34456-00 </p> <p>0127.28 90x110 A SL LD FPM</p>  <p>81-34403-00 </p> <p>0236.44 36x50 A SL FPM</p>  <p>81-38657-00 </p> <p>0236.74 39x50 A SL RD PTFE (Polytetrafluorethylen)/ACM (Polyacryl-Kautschuk)</p> 	

PEUGEOT

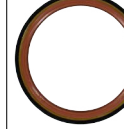

Ltr.  2,0 EW10D (RLZ) 103 kW (140 PS) 406 16V HPI 05/01-10/04  1

 <b>01-35045-02</b> 0197.Y1 +0209.Z3 +0249.A8 +0249.A7 (4x) 	 <b>02-35045-02</b> 	 <b>08-37006-01</b> 		 <b>61-35045-00</b> 0209.Z3 85 0 MLS 	 <b>14-32234-01</b> 0204.A7 (10x) 	 <b>71-36967-00</b> 0249.A8 	 <b>12-34439-01</b> 0956.45 (16x)  <b>70-34439-00</b> 0956.45 16x 	 <b>71-33853-00</b>  0349.H8 	 <b>70-31414-10</b> 	 <b>81-34454-10 K</b>  16 089 406 80 40x55 A SL RD PTFE  <b>81-34456-00 K</b>  0127.28 90x110 A SL LD FPM  <b>81-34403-00 N</b> 0236.44 36x50 A SL FPM  <b>81-36966-00 N</b> 0236.65 39x50 A SL RD FPM 
---	---	---	--	---	--	--	--	--	---	---











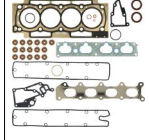

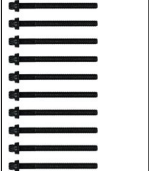

















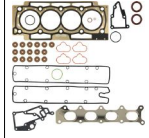

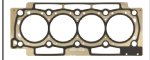
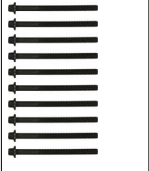







2,0 EW10J4 (RFN) 99-105 kW (135-143 PS) EXPERT 01/99  
 RFR (EW10J4) 206 206 CC 206 SW 16V 307 307 CC 16V 307 SW 16V 307 16V 406 16V 407 407 SW 607 806 806 16V 807

 <b>01-35045-01</b> 0197.Y1 +0209.Z3 +0249.A4 +0249.A5 	 <b>02-35045-01</b> 	 <b>08-37006-01</b> 		 <b>61-35045-00</b> 0209.Z3 85 0 MLS 	 <b>14-32234-01</b> 0204.A7 (10x) 	 <b>71-34452-00 R</b> 0249.A5  <b>71-34453-00 L</b> 0249.A4 	 <b>12-34439-01</b> 0956.45 (16x)  <b>70-34439-00</b> 0956.45 16x 	 <b>71-35903-00</b>  4x 0348.P1  <b>71-33853-00</b>  0349.H8 	 <b>70-31414-10</b> 	 <b>81-34454-10 K</b>  16 089 406 80 40x55 A SL RD PTFE  <b>81-34456-00 K</b>  0127.28 90x110 A SL LD FPM  <b>81-34403-00 N</b> 2x 0236.44 36x50 A SL FPM 
--	--	--	---	--	--	---	---	--	--	---

PEUGEOT

Ltr.   

2,0 EW10J4S (RFK) 130-132 kW (177-180 PS) 206 307 CC 16V 307 16V 07/03-06/09

<p><b>01-35045-04</b></p> 	<p><b>02-35045-04</b></p> 	<p><b>08-37006-04</b></p> 		<p><b>61-35045-00</b> 0209.Z3 85 Ø MLS</p> 	<p><b>14-322342-01</b> 0204.A3 (10x)</p> 	<p><b>71-34452-00 R</b> 0249.A5</p>  <p><b>71-34453-00 L</b> 0249.A4</p> 	<p><b>12-34439-01</b> 0956.45 (16x)</p>  <p><b>70-34439-00</b> 0956.45</p> 	<p><b>71-36957-00 I</b>   0348.R8</p>  <p><b>71-33853-00</b>  0349.H8</p> 	<p><b>70-31414-10</b></p> 	<p><b>81-34454-10 K</b>   16 089 406 80 40x55 A SL RD PTFE</p>  <p><b>81-34456-00 K</b>   0127.28 90x110 A SL LD FPM</p>  <p><b>81-34403-00 N</b> 2x 0236.44 36x50 A SL FPM</p> 
<p><b>01-35045-01</b> 0197.Y1 +0209.Z3 +0249.A4 +0249.A5</p> 	<p><b>02-35045-01</b></p> 	<p><b>08-37006-01</b></p> 		<p><b>61-35045-00</b> 0209.Z3 85 Ø MLS</p> 	<p><b>14-32234-01</b> 0204.A7 (10x)</p> 	<p><b>71-34452-00 AS R</b> 0249.A5</p>  <p><b>71-34453-00 ES L</b> 0249.A4</p> 	<p><b>12-34439-01</b> 0956.45 (16x)</p>  <p><b>70-34439-00</b> 0956.45</p> 	<p><b>71-35903-00 I</b>   0348.P1</p>  <p><b>71-33853-00</b>  0349.H8</p> 	<p><b>70-31414-10</b></p> 	<p><b>81-34454-10 K</b>   16 089 406 80 40x55 A SL RD PTFE</p>  <p><b>81-34456-00 K</b>   0127.28 90x110 A SL LD FPM</p>  <p><b>81-34403-00 N</b> 2x 0236.44 36x50 A SL FPM</p> 

PEUGEOT														
Ltr.														
2,0 RGX (XU10J2CTE)	108 kW (147 PS)													
		<b>1</b>			<b>02-26237-02</b> 0197.H3 	<b>08-25918-04</b> 		<b>61-33650-00</b> 0209.J8 87 Ø 1,35 mm 	<b>14-32077-01</b> 0204.65 (10x) 	<b>71-26237-00</b> 0249.48 	<b>12-25837-01</b> 0956.22 (8x) 	<b>71-33676-00</b> 0348.E0  <b>71-34361-00</b> 0348.N0 2x 	<b>71-25918-30</b> 0304.34 	<b>81-25826-10</b> 0326.12 42x62 A RD FPM  <b>81-34456-00</b> 0127.28 90x110 A SL LD FPM 
														<b>81-22660-00</b> 0236.24 32x45 A LD FPM  <b>81-34403-00</b> 0236.44 36x50 A SL FPM 
2,0 RHF (DW10BTD4)	103 kW (140 PS)	308 HDI 508 HDI	04/09-12/18	<b>01-36571-01</b> 0197.AE +0348.S3 	<b>02-36571-01</b> 0197.AC +0348.S3 		<b>04-10092-01</b> 	<b>61-34370-00</b> 0209.AV 86 Ø 1,25 mm MLS  <b>61-34370-10</b> 0209.AW 86 Ø 1,3 mm MLS  <b>61-34370-20</b> 0209.AX 86 Ø 1,35 mm MLS  <b>61-34370-30</b> 0209.AY 86 Ø 1,4 mm MLS 	<b>14-35774-01</b> 0204.A6 (10x) 	<b>15-36571-01</b> 0348.S3 	<b>12-34399-02</b> 0956.48 (16x)  <b>70-34399-00</b> 0956.48 16x 	<b>71-33223-00</b> 0349.J2 	<b>70-31414-10</b> 	<b>81-36557-00</b> 0127.47 42x62 A SL RD PTFE  <b>81-36556-00</b> 0127.45 90x110 A SL LD PTFE  <b>81-34144-00</b> 0807.28 27x47 A SL RD FPM 

PEUGEOT

Ltr. 2,0 RHZ (DW10BTEd) 80 kW (109 PS) EXPERT HDI 07/00-12/06 1

<p><b>01-34398-01</b> 0197.X4 +0249.99</p>	<p><b>02-34398-01</b> 0197.X3 +0249.99</p>		<p><b>04-10177-01</b> </p>	<p><b>61-35815-00</b> 0209.X5 86 Ø 1,3 mm MLS</p> <p><b>61-35815-10</b> 0209.X6 86 Ø 1,35 mm MLS</p> <p><b>61-35815-20</b> 0209.X7 86 Ø 1,4 mm MLS</p> <p><b>61-35815-30</b> 0209.X8 86 Ø 1,45 mm MLS</p> <p><b>61-35815-40</b> 0209.X9 86 Ø 1,5 mm MLS</p>	<p><b>14-35774-01</b> 0204.A6 (10x)</p>	<p><b>71-34398-00</b> 0249.99</p>	<p><b>12-34399-01</b> 0956.48 (8x)</p> <p><b>70-34399-00</b> 0956.48</p>	<p><b>71-34401-00</b> </p> <p>0348.N4</p> <p><b>71-34402-00</b> </p> <p>0349.H4</p> <p>8x</p>	<p><b>70-31414-10</b></p>	<p><b>81-25826-10</b> </p> <p>0326.12 42x62 A RD FPM  → 10052</p> <p><b>81-36557-00</b> </p> <p>0127.47 42x62 A SL RD PTFE  10053→</p> <p><b>81-34456-00</b> </p> <p>0127.28 90x110 A SL LD FPM  → 10052</p> <p><b>81-36556-00</b> </p> <p>0127.45 90x110 A SL LD PTFE  10053→</p> <p><b>81-34144-00</b> <b>N</b></p> <p>0807.28 27x47 A SL RD FPM</p>

PEUGEOT

Ltr. 2,0 RHZ (DW10CTED) 80 kW (109 PS) EXPERT HDI 07/00-12/06 1



01-34398-01  
0197.X4  
+0249.99

02-34398-01  
0197.X3  
+0249.99

04-10177-01

61-35815-00  
0209.X5  
86 Ø  
1,3 mm  
MLS

61-35815-10  
0209.X6  
86 Ø  
1,35 mm  
MLS

61-35815-20  
0209.X7  
86 Ø  
1,4 mm  
MLS

61-35815-30  
0209.X8  
86 Ø  
1,45 mm  
MLS

61-35815-40  
0209.X9  
86 Ø  
1,5 mm  
MLS

14-35774-01  
0204.A6 (10x)

71-34398-00  
0249.99

12-34399-01  
0956.48 (8x)

71-34401-00

0348.N4

71-34402-00

0349.H4

70-31414-10

81-25926-10

0326.12  
42x62  
A RD FPM  
 → 10052

81-34456-00

0127.28  
90x110  
A SL LD FPM  
 → 10052

81-34144-00 **N**

0807.28  
27x47  
A SL RD FPM

08-25918-04

61-33650-00  
0209.J8  
87 Ø  
1,35 mm

14-32077-01  
0204.65 (10x)

2,0 R6A (XU10J2) 94 kW (128 PS) 605 09/89-12/92

02-33650-03  
0197.T8  
+0209.J8

71-26237-00  
0249.48

12-25837-01  
0956.22 (8x)

71-33738-00

0348.E6

71-26236-10

0349.70

70-25837-00  
0956.22

70-31414-10

81-25926-10

0326.12  
42x62  
A RD FPM

81-34456-00

0127.28  
90x110  
A SL LD FPM

81-26244-10 **N**

0236.21  
36x50  
A RD ACM

81-26244-10 **N**

0236.21  
36x50  
A RD ACM

81-26244-10 **N**

0236.21  
36x50  
A RD ACM















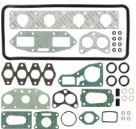
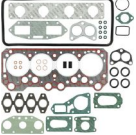



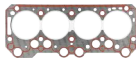

























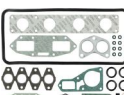



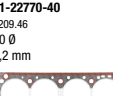
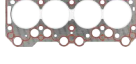
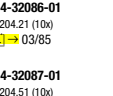

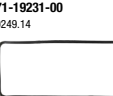
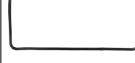
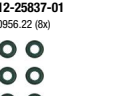
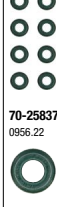









81-26244-10 **N**

0236.21  
36x50  
A RD ACM

81-26244-10 **N**

























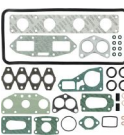



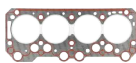
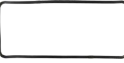





















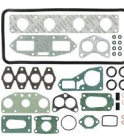



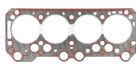
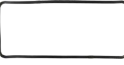

0236.21  
36x50  
A RD ACM

PEUGEOT

<p>Ltr.   </p> <p>2,0 XN1 XN1 (106) XN1A (106E)</p> <p>64-75 kW (87-102 PS)</p> <p>5008 505</p> <p>03/82-09/95</p>		 <p>02-19231-01</p>  <p>02-22770-10</p> 			 <p>61-22770-40 0209.46 90 0 1,2 mm</p> 	 <p>14-32087-01 0204.51 (10x)</p>	 <p>71-19231-00 0249.14</p> 	 <p>12-25837-01 0956.22 (8x)</p>  <p>8x</p>	 <p>71-24661-10   0348.33</p>  <p>71-23049-10   0348.21</p>  <p>71-17538-10  0349.03</p>  <p>71-21274-20   1710.09</p>  <p>71-24581-10   1710.19</p> 	 <p>71-12921-20 0304.44</p> 	 <p>81-27333-00  0514.11 42x60 A RD ACM</p> 
<p>2,0 XN1 XN1 (106)</p> <p>68-71 kW (92-97 PS)</p> <p>504 505</p> <p>03/71-07/86</p>		 <p>02-19231-01</p>  <p>02-22770-10</p> 			 <p>61-22770-40 0209.46 90 0 1,2 mm</p> 	 <p>14-32086-01 0204.21 (10x)  03/85</p> <p>14-32087-01 0204.51 (10x)  04/85 →</p>	 <p>71-19231-00 0249.14</p> 	 <p>12-25837-01 0956.22 (8x)</p>  <p>8x</p>	 <p>71-24661-10   0348.33</p>  <p>71-23049-10   0348.21</p>  <p>71-17538-10  0349.03</p>  <p>71-21274-20   1710.09</p>  <p>71-24581-10   1710.19</p> 	 <p>71-12921-20 0304.44</p> 	 <p>81-27333-00  0514.11 42x60 A RD ACM</p> 





PEUGEOT





















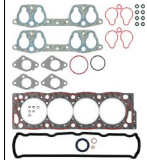

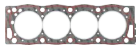

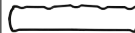

<p>Ltr. </p>	<p>2,0 XN1 69-79 kW (94-107 PS) 504 505 05/79-08/82 </p>											
<p>2,0 XN1P XN1T (170) 57-58 kW (78-79 PS) J5 J9 J9 Bus 03/80-08/90</p>		<p>02-19231-01</p>  <p>02-22770-10</p> 			<p>61-22770-40 0209.46 90 0 1,2 mm</p> 	<p>14-32086-01 0204.21 (10x) 06/85</p> <p>14-32087-01 0204.51 (10x) 07/85 →</p>	<p>71-19231-00 0249.14</p> 	<p>12-23062-01 0956.22 (8x)</p>  <p>70-25837-00 0956.22</p> 	<p>71-24661-10 </p> <p>0348.33</p>  <p>71-23049-10  </p> <p>0348.21</p>  <p>71-17538-10 </p> <p>0349.03</p>  <p>71-21274-20   </p> <p>1710.09</p>  <p>71-24581-10   </p> <p>1710.19</p> 	<p>71-12921-20 0304.44</p> 	<p>81-27333-00 </p> <p>0514.11 42x60 A RD ACM</p> 	
<p>2,0 XN1T 55 kW (75 PS) J5 09/87-08/90</p>		<p>02-19231-01</p>  <p>02-22770-10</p> 			<p>61-22770-40 0209.46 90 0 1,2 mm</p> 	<p>14-32087-01 0204.51 (10x) 04/89</p> <p>14-32079-01 0204.57 (10x) 05/89 →</p>	<p>71-19231-00 0249.14</p> 	<p>12-23062-01 0956.30 (8x)</p>  <p>70-23062-00 0956.05</p> 	<p>71-24661-10 </p> <p>0348.33</p>  <p>71-23049-10  </p> <p>0348.21</p>  <p>71-17538-10 </p> <p>0349.03</p> 	<p>71-12921-20 0304.44</p> 	<p>81-27333-00 </p> <p>0514.11 42x60 A RD ACM</p> 	

PEUGEOT











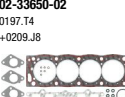

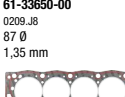

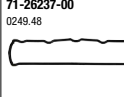



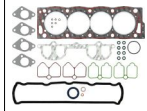

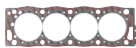
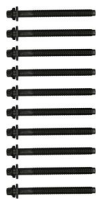





Ltr.	Motor	Power	Model	Year	Image 1	Image 2	Image 3	Image 4	Image 5	Image 6	Image 7	Image 8	Image 9	Image 10	Image 11
2,0	XN1T (170) XN1T (170B) XN1TA XN1TA (170C)	55-72 kW (75-98 PS)	J5 Bus	09/81											
						<p><b>02-19231-01</b></p> <p><b>02-22770-10</b></p>			<p><b>61-22770-40</b> 0209.46 90 0 1,2 mm</p>	<p><b>14-32086-01</b> 0204.21 (10x) 06/85</p> <p><b>14-32087-01</b> 0204.51 (10x) 07/85→ 04/89</p> <p><b>14-32079-01</b> 0204.57 (10x) 05/89→</p>	<p><b>71-19231-00</b> 0249.14</p>	<p><b>12-23062-01</b> 0956.30 (8x)</p> <p><b>70-23062-00</b> 0956.05</p> <p>8x</p>	<p><b>71-24661-10</b> </p> <p>0348.33</p> <p><b>71-23049-10</b> </p> <p>0348.21</p> <p><b>71-17538-10</b> </p> <p>0349.03</p>	<p><b>71-12921-20</b> 0304.44</p>	<p><b>81-27333-00</b> </p> <p>0514.11 42x60 A RD ACM</p>
2,0	XN1T (170B)	55 kW (75 PS)	J5	01/86-11/88											
						<p><b>02-19231-01</b></p> <p><b>02-22770-10</b></p>			<p><b>61-22770-40</b> 0209.46 90 0 1,2 mm</p>	<p><b>14-32087-01</b> 0204.51 (10x)</p>	<p><b>71-19231-00</b> 0249.14</p>	<p><b>12-23062-01</b> 0956.30 (8x)</p> <p><b>70-23062-00</b> 0956.05</p> <p>8x</p>	<p><b>71-24661-10</b> </p> <p>0348.33</p> <p><b>71-23049-10</b> </p> <p>0348.21</p> <p><b>71-17538-10</b> </p> <p>0349.03</p>	<p><b>71-12921-20</b> 0304.44</p>	<p><b>81-27333-00</b> </p> <p>0514.11 42x60 A RD ACM</p>
2,0	XN2 (107)	75-78 kW (102-106 PS)	504 504 TI	01/71-08/84											
						<p><b>02-19231-01</b></p> <p><b>02-22770-10</b></p>			<p><b>61-22770-40</b> 0209.46 90 0 1,2 mm</p>	<p><b>14-32086-01</b> 0204.21 (10x)</p>	<p><b>71-19231-00</b> 0249.14</p>	<p><b>12-25837-01</b> 0956.22 (8x)</p> <p><b>70-25837-00</b> 0956.22</p> <p>8x</p>	<p><b>71-22583-10</b> </p> <p>0348.18</p> <p><b>71-17538-10</b> </p> <p>0349.03</p> <p><b>71-21274-20</b> </p> <p>1710.09</p>	<p><b>71-12921-20</b> 0304.44</p>	<p><b>81-27333-00</b> </p> <p>0514.11 42x60 A RD ACM</p>

PEUGEOT

Ltr.  2,0 XU10J2 (RFU) 89 kW (121 PS) 806  06/94-08/02  1













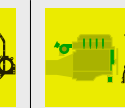

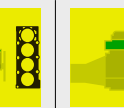

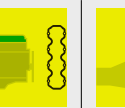
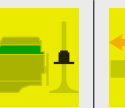
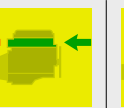

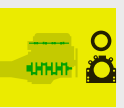
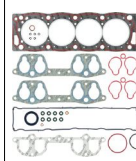

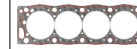







										
	<p><b>02-33650-03</b> 0197.T8 +0209.J8</p> 	<p><b>08-25918-04</b></p> 		<p><b>61-33650-00</b> 0209.J8 87 Ø 1,35 mm</p> 	<p><b>14-32077-01</b> 0204.65 (10x)</p> 	<p><b>71-26237-00</b> 0249.48</p> 	<p><b>12-25837-01</b> 0956.22 (8x)</p>  <p><b>70-25837-00</b> 0956.22</p> 	<p><b>71-34361-00</b>  2x 0349.N0</p>  <p><b>71-26236-10</b>  4x 0349.70</p> 	<p><b>70-31414-10</b></p> 	<p><b>81-25926-10</b>  <b>K</b></p> <p>0326.12 42x62 A RD FPM</p>  <p><b>81-34456-00</b>  <b>K</b></p> <p>0127.28 90x110 A SL LD FPM</p>  <p><b>81-26244-10</b> <b>N</b></p> <p>0236.21 36x50 A RD ACM</p> 

2,0 XU10J2 (RFW) 80-81 kW (109-110 PS) BOXER BOXER Bus 03/94-06/06











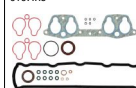















										
	<p><b>02-33650-02</b> 0197.T4 +0209.J8</p> 	<p><b>08-25918-04</b></p> 		<p><b>61-33650-00</b> 0209.J8 87 Ø 1,35 mm</p> 	<p><b>14-32077-01</b> 0204.65 (10x)</p> 	<p><b>71-26237-00</b> 0249.48</p> 	<p><b>12-25837-01</b> 0956.22 (8x)</p>  <p><b>70-25837-00</b> 0956.22</p> 	<p><b>71-33663-00</b>  2x 0348.F6</p>  <p><b>71-33738-00</b>   2x 0348.E6</p>  <p><b>71-26236-10</b>  4x 0349.70</p> 	<p><b>70-31414-10</b></p> 	<p><b>81-25926-10</b>  <b>K</b></p> <p>0326.12 42x62 A RD FPM</p>  <p><b>81-34456-00</b>  <b>K</b></p> <p>0127.28 90x110 A SL LD FPM</p>  <p><b>81-26244-10</b> <b>N</b></p> <p>0236.21 36x50 A RD ACM</p> 

PEUGEOT

Ltr.  2,0 XU10J2 (RFX) 89-92 kW (121-125 PS) 306 306 XSI 405  1  08/92-04/02













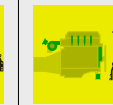

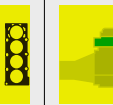
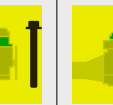
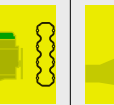
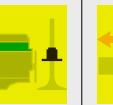



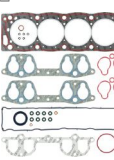

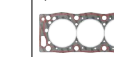

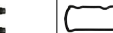
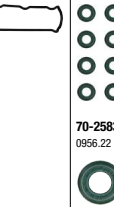



											
	<p><b>02-33650-01</b> 0197.G6 +0209.J8</p> 	<p><b>08-25918-04</b></p> 		<p><b>61-33650-00</b> 0209.J8 87 Ø 1,35 mm</p> 	<p><b>14-32077-01</b> 0204.65 (10x)</p> 	<p><b>71-33664-00</b> 0249.71</p> 	<p><b>12-25837-01</b> 0956.22 (8x)</p> <p><b>70-25837-00</b> 0956.22</p> 	<p><b>71-34361-00</b>  2x 0348.N0</p>  <p><b>71-26236-10</b>  4x 0349.70</p> 	<p><b>71-25918-30</b>   0304.34</p> 	<p><b>81-25926-10</b>   0326.12 42x62 A RD FPM</p>  <p><b>81-34456-00</b>   0127.28 90x110 A SL LD FPM</p>  <p><b>81-26244-10</b> <b>N</b> 0236.21 36x50 A RD ACM</p> 	

2,0 XU10J2TE (RGX) 104-108 kW (141-147 PS) 406 406 Turbo 605 Turbo 806 806 Turbo 07/91-10/04











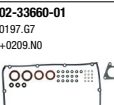
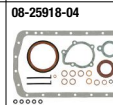

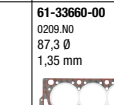
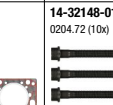
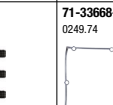
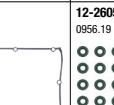
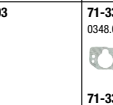
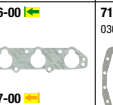
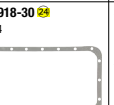



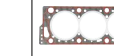
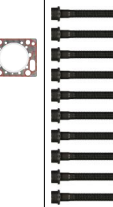
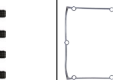
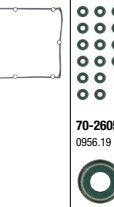

	<p><b>02-26237-02</b> 0197.H3</p> 	<p><b>08-25918-04</b></p> 		<p><b>61-33650-00</b> 0209.J8 87 Ø 1,35 mm</p> 	<p><b>14-32077-01</b> 0204.65 (10x)</p> 	<p><b>71-26237-00</b> 0249.48</p> 	<p><b>12-25837-01</b> 0956.22 (8x)</p> <p><b>70-25837-00</b> 0956.22</p> 	<p><b>71-33676-00</b>   0348.E0  07664</p>  <p><b>71-34361-00</b>  2x 0348.N0  07665 →</p> 	<p><b>71-25918-30</b> 0304.34</p> 	<p><b>81-25926-10</b>   0326.12 42x62 A RD FPM</p>  <p><b>81-34456-00</b>   0127.28 90x110 A SL LD FPM</p>  <p><b>81-34403-00</b> <b>N</b>   0236.44 36x50 A SL FPM</p>  <p><b>81-22660-00</b> <b>N</b>   0236.24 32x45 A LD FPM</p> 
--	---	--	--	--	---	---	--	--	---	---

PEUGEOT

Ltr.  2,0 XU10JZZ (RFZ) 89 kW (121 PS) 605  06/89-09/99  1

											
	<p><b>02-33650-01</b> 0197.66 +0209.J8 1 → 03/94</p> 	<p><b>08-25918-04</b></p> 		<p><b>61-33650-00</b> 0209.J8 87 Ø 1,35 mm</p> 	<p><b>14-32077-01</b> 0204.65 (10x)</p> 	<p><b>71-26237-00</b> 0249.48</p> 	<p><b>12-25837-01</b> 0956.22 (8x)</p> <p><b>70-25837-00</b> 0956.22</p> 	<p><b>71-31379-10</b>  </p> <p>0348.76</p>  <p><b>71-26236-10</b>  4x</p> <p>0349.70</p> 	<p><b>71-25918-30</b> </p> <p>0304.34 1 → 09/93</p>  <p><b>70-31414-10</b> 1 → 10/93 →</p> 	<p><b>81-25926-10</b> </p> <p>0326.12 42x62 A RD FPM</p>  <p><b>81-34456-00</b> </p> <p>0127.28 90x110 A SL LD FPM</p>  <p><b>81-26244-10</b> <b>N</b></p> <p>0236.21 36x50 A RD ACM</p> 	

2,0 XU10J4 (RFT) 110-144 kW (150-196 PS) 306 01/92-05/01  
 XU10J4TE/Z (RGZ) 306 S16  
 XU10J4Z (RFY) 405  
 405 Turbo  
 405 16V

											
	<p><b>02-33660-01</b> 0197.67 +0209.N0</p> 	<p><b>08-25918-04</b></p> 		<p><b>61-33660-00</b> 0209.N0 87,3 Ø 1,35 mm</p> 	<p><b>14-32148-01</b> 0204.72 (10x)</p> 	<p><b>71-33668-00</b> 0249.74</p> 	<p><b>12-26058-03</b> 0956.19 (16x)</p> <p><b>70-26058-00</b> 0956.19</p> 	<p><b>71-33666-00</b> </p> <p>0348.C8</p>  <p><b>71-33667-00</b> </p> <p>0349.98</p> 	<p><b>71-25918-30</b> </p> <p>0304.34</p> 	<p><b>81-25926-10</b> </p> <p>0326.12 42x62 A RD FPM</p>  <p><b>81-34456-00</b> </p> <p>0127.28 90x110 A SL LD FPM</p>  <p><b>81-26244-10</b> <b>N</b> 2x</p> <p>0236.21 36x50 A RD ACM</p> 	

PEUGEOT

Ltr.    1

2,0 XU10J4R (RFV) 97 kW (132 PS) 306  
306 16V  
406 16V  
605 16V  
806 16V

07/94-12/04

**01-33650-05**  
0197.V2  
+0209.N6  
+0249.A2  
+0249.A3  
→ 07965

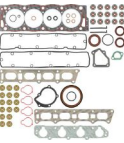

**01-33650-06**  
0197.X8  
+0209.N6  
+0249.A2  
+0249.A3  
→ 07966→

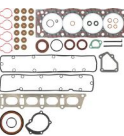

**02-33650-05**  
→ 07965

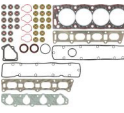

**02-33650-06**  
→ 07966→

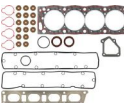



**61-33650-00**  
0209.J8  
87 Ø  
1,35 mm



**14-32148-01**  
0204.72 (10x)



**71-34446-00 R**  
0249.A3



**71-34447-00 L**  
0249.A2



**12-35257-01**  
0956.34 (16x)  
→ 07359



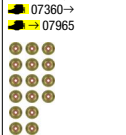

**12-34438-01**  
0956.42 (16x)  
→ 07360→  
→ 07965





**12-34439-01**  
0956.45 (16x)  
→ 07966→





**71-33666-00**   
0348.C8  
→ 07328





**71-35728-00**  4x  
0348.L3



**71-34443-00**   
0349.F4  
→ 07664



**71-35768-00**   
0349.H0  
→ 07665→



**70-31414-10**



**81-25826-10**   
0326.12  
42x62  
A RD FPM





**81-34456-00**   
0127.28  
90x110  
A SL LD FPM



**81-34403-00**  2x  
0236.44  
36x50  
A SL FPM



PEUGEOT

Ltr.    1

2,0 XU10J4R (RFV) 97-100 kW (132-136 PS) 306  
306 16V  
406 16V  
806

03/97-12/04



**01-33650-05**  
0197.V2  
+0209.N6  
+0249.A2  
+0249.A3  
→ 07965



**01-33650-06**  
0197.X8  
+0209.N6  
+0249.A2  
+0249.A3  
→ 07966→



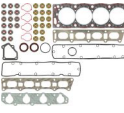

**02-33650-05**  
→ 07965

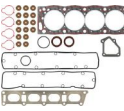

**02-33650-06**  
→ 07966→



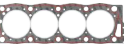

**61-33650-00**  
0209.J8  
87 Ø  
1,35 mm





**14-32148-01**  
0204.72 (10x)





**71-34446-00 R**  
0249.A3



**71-34447-00 L**  
0249.A2





**12-35257-01**  
0956.34 (16x)  
→ 07359



**12-34438-01**  
0956.42 (16x)  
→ 07360→  
→ 07965



**12-34439-01**  
0956.45 (16x)  
→ 07966→



**70-35257-00**  
0956.34  
→ 07359





**70-34438-00**  
0956.42  
→ 07360→  
→ 07965



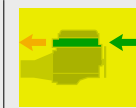

**70-34439-00**  
0956.45  
→ 07966→





**71-33666-00**    
0348.C8  
→ 07965





**71-35728-00**  4x  
0348.L3  
→ 07966→



**71-34443-00**   
0348.F4  
→ 07664





**71-35768-00**   
0348.H0  
→ 07665→



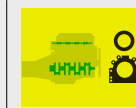

**70-31414-10**





**81-25826-10**   
0326.12  
42x62  
A RD FPM





**81-34456-00**   
0127.28  
90x110  
A SL LD FPM



**81-34403-00**  2x  
0236.44  
36x50  
A SL FPM



**PEUGEOT**

Ltr.   

2,0 XU10J4R (RFV) 99 kW (135 PS) 605 01/94-05/99

**01-33650-05**  
0197.V2  
+0209.N6  
+0249.A2  
+0249.A3  
→ 07965

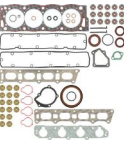

**01-33650-06**  
0197.X8  
+0209.N6  
+0249.A2  
+0249.A3  
→ 07966→

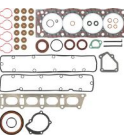

**02-33650-05**  
→ 07965

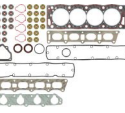

**02-33650-06**  
→ 07966→



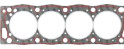
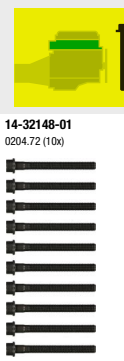

**61-33650-00**  
0209.J8  
87 Ø  
1,35 mm

**71-34446-00 R**  
0249.A3



**71-34447-00 L**  
0249.A2



**12-35257-01**  
0956.34 (16x)  
→ 07359





**12-34438-01**  
0956.42 (16x)  
→ 07360→  
→ 07965





**12-34439-01**  
0956.45 (16x)  
→ 07966→





**71-33666-00**    
0348.C8  
→ 07328





**71-35728-00**  4x  
0348.L3  
→ 07329→



**71-34443-00**   
0348.F4  
→ 07664



**71-35768-00**   
0348.H0  
→ 07665→



**70-31414-10**



**81-25826-10**   
0326.12  
42x62  
A RD FPM



**81-34456-00**   
0127.28  
90x110  
A SL LD FPM

































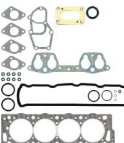









**81-34403-00**  2x  
0236.44  
36x50  
A SL FPM



















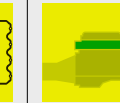
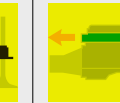
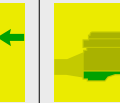
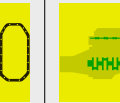



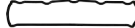







PEUGEOT













<p>Ltr. </p> <p>2,0 XU10J4RS (RFS) 120-124 kW (163-169 PS) 306 306 S16</p> <p>  1</p> <p>06/96-05/01</p> <p><b>01-35050-01</b> 0197.W2 +0209.Z2</p> 	<p><b>02-35050-01</b></p> 	<p><b>08-25918-04</b></p> 		<p><b>61-35050-00</b> 0209.Z2 86,5 Ø MLS</p> 	<p><b>14-32148-01</b> 0204.72 (10x)</p> 		<p><b>12-31306-01</b></p>  <p><b>70-31306-00</b> 0956.64</p> 	<p><b>71-33666-00</b> </p> <p>0348.C8</p>  <p><b>71-34443-00</b> </p> <p>0349.F4</p>  <p>16x</p>	<p><b>70-31414-10</b></p> 	<p><b>81-25926-10</b> </p> <p>0326.12 42x62 A RD FPM</p>  <p><b>81-34456-00</b> </p> <p>0127.28 90x110 A SL LD FPM</p>  <p><b>81-34403-00</b> <b>N</b> 2x</p> <p>0236.44 36x50 A SL FPM</p> 
<p>2,0 XU10MZ 79 kW (107 PS) 605</p> <p>02/90-09/99</p>	<p><b>02-33665-01</b> 0197.C9 +0209.N1</p> 	<p><b>08-25918-04</b></p> 		<p><b>61-33665-00</b> 0209.N1 87 Ø 1,35 mm</p> 	<p><b>14-32077-01</b> 0204.65 (10x)</p> 	<p><b>71-26237-00</b> 0249.48</p> 	<p><b>12-25837-01</b> 0956.22 (8x)</p>  <p><b>70-25837-00</b> 0956.22</p> 	<p><b>71-33676-00</b> </p> <p>0348.E0</p>  <p><b>71-26236-10</b> </p> <p>0349.70</p>  <p>4x</p> <p>8x</p>	<p><b>71-25918-30</b> 0304.34</p> 	<p><b>81-25926-10</b> </p> <p>0326.12 42x62 A RD FPM</p>  <p><b>81-34456-00</b> </p> <p>0127.28 90x110 A SL LD FPM</p>  <p><b>81-26244-10</b> <b>N</b></p> <p>0236.21 36x50 A RD ACM</p> 

PEUGEOT











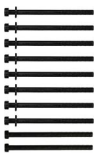
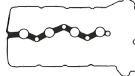

Ltr.  XU102C (R5A) 84 kW (114 PS) 605  1 06/89-09/99

										
	<p><b>02-33665-01</b> 0197.C9 +0209.N1</p> 	<p><b>08-25918-04</b></p> 		<p><b>61-33665-00</b> 0209.N1 87 Ø 1,35 mm</p> 	<p><b>14-32077-01</b> 0204.65 (10x)</p> 	<p><b>71-26237-00</b> 0249.48</p> 	<p><b>12-25837-01</b> 0956.22 (8x)</p> 	<p><b>71-33676-00</b>  </p> <p>0348.E0</p>  <p><b>71-26236-10</b>  4x</p> <p>0349.70</p> 	<p><b>71-25918-30</b> 0304.34   6140</p>  <p><b>70-31414-10</b>  6141 →</p> 	<p><b>81-25826-10</b> </p> <p>0326.12 42x62 A RD FPM</p>  <p><b>81-34456-00</b> </p> <p>0127.28 90x110 A SL LD FPM</p>  <p><b>81-26244-10</b> <b>N</b></p> <p>0236.21 36x50 A RD ACM</p> 



2,0 ZEJ (829) 77-81 kW (105-110 PS)

				<p><b>61-27685-10</b> 0203.02 89 Ø 1,3 mm</p> 		<p><b>71-24461-00</b> 0249.43</p> 	<p><b>12-25837-01</b> 0956.22 (8x)</p> 	<p><b>71-24046-40</b> </p> <p>0349.32</p>  <p><b>71-24503-10</b>  </p> <p>1710.26</p> 	<p><b>71-12972-00</b> 0304.20</p> 	<p><b>81-16737-20</b> </p> <p>50x68 A SL RD FPM</p>  <p><b>81-20745-30</b> </p> <p>0127.12 90x110 A SL LD FPM</p> 
--	--	--	--	---	--	---	--	---	---	--

2,0 4B11 108-110 kW (147-150 PS) 4007 4008 11/10











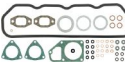

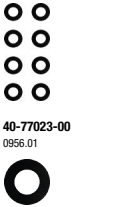

<p><b>01-54035-02</b> 16 082 621 80</p> 				<p><b>61-54035-00</b> 16 082 325 80 87 Ø 0,5 mm</p> 	<p><b>14-12679-01</b> 0204.E3 (8x) +0204.E2 (2x)</p> 	<p><b>71-54092-00</b> 0249.F9</p> 	<p><b>12-54093-01</b> 0956.61 (16x)</p> 	<p><b>71-54094-00</b>  4x</p> <p>0348.V9</p>  <p><b>71-12676-00</b> </p> <p>16 082 604 80</p> 	<p><b>70-31414-10</b></p> 	<p><b>81-54097-00</b> </p> <p>0127.57 42x55 A SL RD FPM</p>  <p><b>81-54098-00</b> </p> <p>0127.51 85x103 A SL LD FPM</p> 
---	--	--	--	---	--	---	---	---	---	---

PEUGEOT



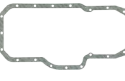







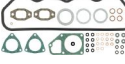



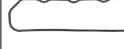

Ltr.  2,1 XDP 4.90 XDP90 XD4x90 42-55 kW (57-75 PS) J7 Bus D J7 D 504 504 D 08/68 













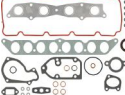







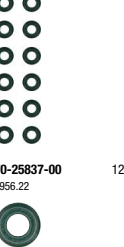

2,1 XDPX90 41 kW (56 PS) J9 D 03/80-06/87

<p><b>02-50919-10</b> 0197.08</p> 	<p><b>08-25857-01</b></p> 	<p><b>61-23635-10</b> 0203.70 94 Ø 1,5 mm  1932463→</p> <p><b>61-23635-20</b> 79 32 566 274 94 Ø 1,8 mm  1932463→</p> 	<p><b>71-50919-10</b> 0249.25</p> 	<p><b>12-77023-01</b> 0956.01 (8x)</p> 	<p><b>71-50920-10</b>  2x 0349.08</p>  <p><b>71-24581-10</b>  06 1710.19</p> 	<p><b>71-25857-10</b> 0313.19</p> 	<p><b>81-51051-20</b>  K↔ 0514.35 45x60 A SL RD FPM</p>  <p><b>71-25853-10</b>  K↔ 2x 0119.03</p> 
---	--	---	---	--	---	---	--

2,1 XDPX90 41 kW (56 PS) J9 D 03/80-06/87

<p><b>02-50919-10</b> 0197.08</p> 	<p><b>08-25857-01</b>  4572282→</p> 	<p><b>61-23635-10</b> 0203.70 94 Ø 1,5 mm  4572282→</p> <p><b>61-23635-20</b> 79 32 566 274 94 Ø 1,8 mm  4572282→</p> 	<p><b>71-50919-10</b> 0249.25  06/86</p> 	<p><b>12-77023-01</b> 0956.01 (8x)</p> 	<p><b>71-50920-10</b>  2x 0349.08</p>  <p><b>71-24581-10</b>  06 1710.19</p> 	<p><b>71-25857-10</b> 0313.19</p> 	<p><b>81-51051-20</b>  K↔ 0514.35 45x60 A SL RD FPM</p>  <p><b>71-25853-10</b>  K↔ 2x 0119.03</p> 
---	---	---	---	--	---	---	--

2,1 XUD11A (P9A) 60 kW (82 PS) 605 D 06/89-07/95

<p><b>02-33673-01</b> 0197.H1</p> 	<p><b>08-25918-03</b></p> 	<p><b>61-27540-00</b> 0209.H1 87 Ø 1,5 mm  1</p> <p><b>61-27540-10</b> 0209.99 87 Ø 1,6 mm  2</p> <p><b>61-27540-20</b> 0209.A0 87 Ø 1,7 mm  3</p> <p><b>61-27540-30</b> 0209.H3 87 Ø 1,8 mm  4</p> 	<p><b>14-32085-01</b> 0204.67 (10x)</p> 	<p><b>71-33673-00</b> 0249.70</p> 	<p><b>12-25837-03</b> 0956.22 (12x)</p> 	<p><b>71-33671-00</b>  K↔ 0348.96</p>  <p><b>71-33672-00</b>  K↔ 0349.76</p> 	<p><b>71-25918-30</b> 0304.34</p> 	<p><b>81-25926-10</b>  K↔ 0326.12 42x62 A RD FPM</p>  <p><b>81-34456-00</b>  K↔ 0127.28 90x110 A SL LD FPM</p>  <p><b>81-21798-30</b>  N 2x 0236.14 35x50 A SL WD ACM</p> 
---	--	---	---	---	--	---	---	---

PEUGEOT

Ltr.   1

2,1 XUD11ATE (PHZ) 80 kW (109 PS) 406 TD 12V 06/89-10/04  
 XUD11BTE (P8C) 605 TD 605 TD 12V 806 806 TD 12V



01-33673-01

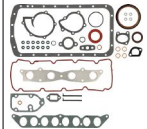

02-33673-01

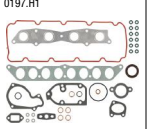

08-25918-03

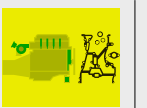
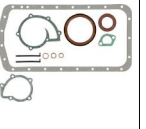

61-33655-00

0209.R4  
86 Ø  
1,52 mm  
MLS

61-33655-10

0209.R5  
86 Ø  
1,57 mm  
MLS

61-33655-20

0209.R6  
86 Ø  
1,62 mm  
MLS

61-33655-30

0209.R7  
86 Ø  
1,67 mm  
MLS

61-33655-40

0209.R8  
86 Ø  
1,72 mm  
MLS

61-33655-50

0209.T4  
86 Ø  
1,77 mm  
MLS

61-33655-60

0209.T6  
86 Ø  
1,35 mm  
MLS

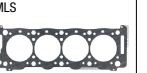

14-32158-01

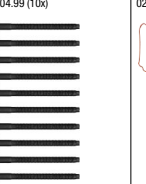

71-33673-00

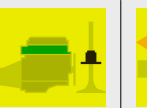

12-25837-03

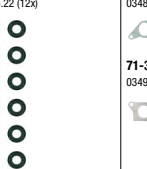

70-25837-00

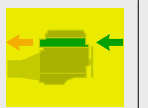

71-33671-00

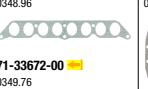

71-33672-00

0349.76



71-25918-30



81-25826-10

0326.12  
42x62  
A RD FPM



81-34456-00

0127.28  
90x110  
A SL LD FPM

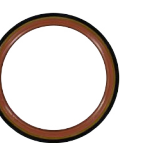

81-21798-30

0236.14  
35x50  
A SL WD ACM



2,2 DW12BTED4 (4HT) 115-150 kW (156-204 PS) 4007 03/06  
 4HK (DW12ME5) 4007 HDI  
 4HK (DW12MTED4) 407 HDI  
 4HL (DW12C) 407 HDI 170  
 4HN (DW12MTED4) 508 HDI  
 4HP (DW12BTED4) 607 HDI  
 4HR (DW12BTED4) 807 HDI  
 4HS (DW12BTED4)



02-39244-01

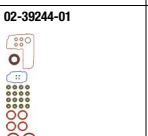

08-39246-01

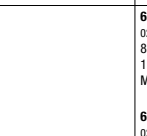

61-35805-00

0209.FT  
85,9 Ø  
1,25 mm  
MLS

61-35805-10

0209.FV  
85,9 Ø  
1,3 mm  
MLS

61-35805-20

0209.FW  
85,9 Ø  
1,35 mm  
MLS

61-35805-30

0209.FX  
85,9 Ø  
1,4 mm  
MLS

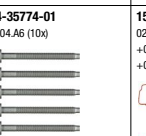
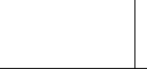

14-35774-01

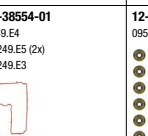

15-38554-01

0249.E4  
+0249.E5 (2x)  
+0249.E3

71-38552-00

0249.E5

71-38554-00

0249.E4

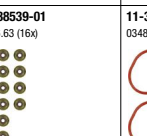

12-38539-01

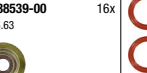

70-38539-00

0956.63



11-38553-01



71-35919-00

0349.P1

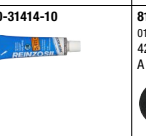

70-31414-10

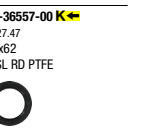

81-36557-00

0127.47  
42x62  
A SL RD PTFE

81-36556-00

0127.45  
90x110  
A SL LD PTFE

81-34144-00

0807.28  
27x47  
A SL RD FPM



PEUGEOT



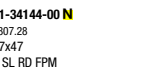
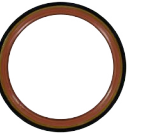
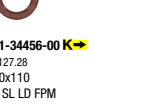
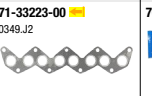
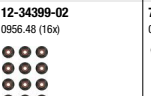
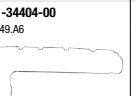
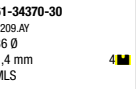
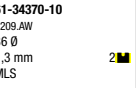
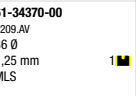
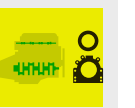
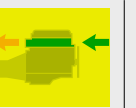



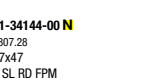
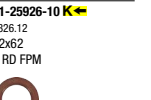
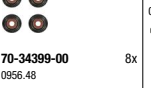
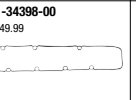
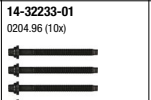
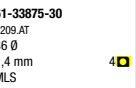
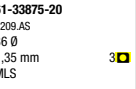
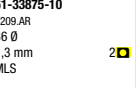

















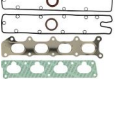
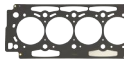







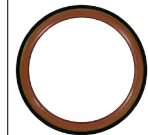

Ltr.  2.2 DW12TED4 (4HX) 98 kW (133 PS) 406 HDI FAP 607 HDI 02/00-02/06  1

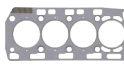

2.2 DW12UTED (4HY) 74 kW (101 PS) BOXER Bus HDI BOXER HDI 12/01-06/06



PEUGEOT

<p>Ltr.   </p>											
<p>2,2 EW12J4 (3FY) 116-120 kW (158-163 PS) 406 EW12J4 (3FZ) 407 407 SW 407 SW 16V 407 16V 607 16V 807</p>	<p><b>01-33025-01</b> 0197.Y8 +0209.0H +0249.A4 +0249.A5</p> 	<p><b>02-33025-01</b></p> 			<p><b>61-33025-00</b> 0209.0H 87 Ø MLS</p> 	<p><b>14-32235-01</b> 0204.95 (10x)</p> 	<p><b>71-34452-00 R</b> 0249.A5</p>   <p><b>71-34453-00 L</b> 0249.A4</p> 	<p><b>12-34439-01</b> 0956.45 (16x)</p>  <p><b>70-34439-00</b> 0956.45</p> 	<p><b>71-33018-00 I</b> 0348.P6</p>  <p><b>71-33853-00</b> 0349.H8</p> 	<p><b>70-31414-10</b></p> 	<p><b>81-34454-10 K</b> 16 089 406 80 40x55 A SL RD PTFE</p>  <p><b>81-34456-10 K</b> 0127.28 90x110 A SL LD FPM</p>  <p><b>81-34403-00 N</b> 0236.44 36x50 A SL FPM</p>  <p><b>81-36966-00 N</b> 0236.65 39x50 A SL RD FPM</p> 
<p>2,2 ZDJ (851) 84-96 kW (114-131 PS) 505 ZDJL (851B) 505 GTI ZDJL (851X)</p>					<p><b>61-27685-10</b> 0203.02 89 Ø 1,3 mm</p> 		<p><b>71-24461-00</b> 0249.43</p> 	<p><b>12-25837-01</b> 0956.22 (8x)</p>  <p><b>70-25837-00</b> 0956.22</p> 	<p><b>71-24046-40</b> 0349.32</p>  <p><b>71-24503-10</b> 1710.26</p> 	<p><b>71-12972-00</b> 0304.20</p> 	<p><b>81-16737-20 K</b> 50x68 A SL RD FPM</p>  <p><b>81-20745-30 K</b> 0127.12 90x110 A SL LD FPM</p> 

PEUGEOT															
2.2	4HA (DW12RUE) 4HH (DW12RUC) 4HJ (DW12RUD) 4HK (DW12RUE)	88-121 kW (120-165 PS)	BOXER HDI BOXER HDI 120 BOXER HDI 140 BOXER HDI 165		07/19										
						02-12453-01 	08-12456-01 	04-10350-01	61-10212-00 98 070 922 80 86 Ø 1,25 mm MLS  1	14-12457-01 98 020 332 80 (10x)  2	71-12453-00 98 012 929 80 	12-38539-01 0956.63 (16x)  16x	71-12455-00 98 009 431 80	70-31414-10  71-12456-00 98 014 448 80 	81-36557-00 0127.47 42x62 A SL RD PTFE  81-36556-00 0127.45 90x110 A SL LD PTFE  81-34144-00 0807.28 27x47 A SL RD FPM 
2.2	4HG (PUMA C) 4HG (P22DTE) 4HH (PUMA C) 4HH (P22DTE) 4HJ (PUMA C) 4HJ (P22DTE)	81-110 kW (110-150 PS)	BOXER BOXER HDI BOXER HDI 110 BOXER HDI 130 BOXER HDI 150		03/11			04-10369-01	61-37365-00 0209.EH 87,5 Ø 1,1 mm MLS  1	14-32341-01 0204.C0 (10x) →0204.A9 (8x)  2	71-42374-00 96 777 474 80 	12-35549-01 0956.59 (16x)  16x	71-35539-00 0348.T1 8x	15-35536-01 0304.58  70-31414-10 	81-90014-00 0514.C6 PTFE  81-90013-00 0514.C4 PTFE 
2.2	4HU (P22DTE) 4HV (P22DTE)	74-88 kW (101-120 PS)	BOXER HDI 100 BOXER HDI 120		04/06	02-35115-04 	08-35536-01 	04-10217-01	61-37365-00 0209.EH 87,5 Ø 1,1 mm MLS  1	14-32341-01 0204.C0 (10x) →0204.A9 (8x)  2	71-35115-00 0249.E9 	12-35549-01 0956.59 (16x)  16x	71-35539-00 0348.T1 8x	15-35536-01 0304.58  70-31414-10 	81-90014-00 0514.C6 PTFE  81-90013-00 0514.C4 PTFE 

PEUGEOT

Ltr.     
 2.2 4HW (DW12ATED4) 94-100 kW (128-136 PS) 807 HDI 06/02  
 4HW (DW12TED4) 807 HDI FAP

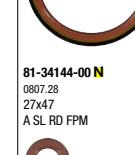
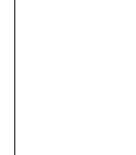
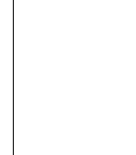
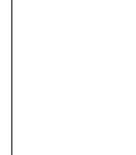
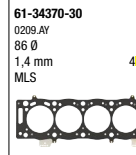
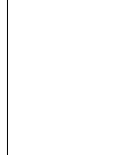
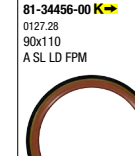
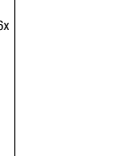
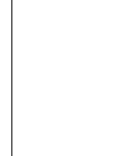
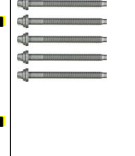
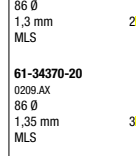
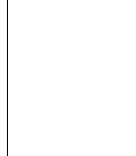
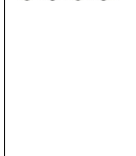
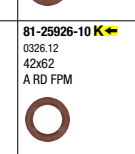
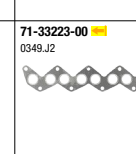
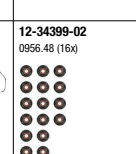
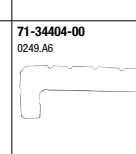
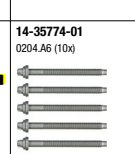
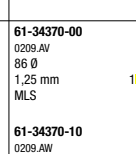
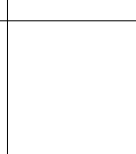
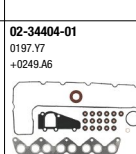
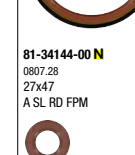
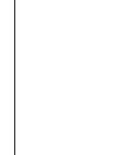
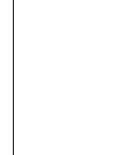
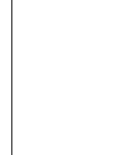
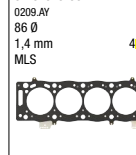
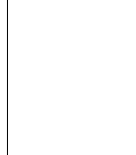
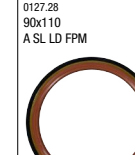
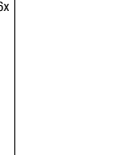
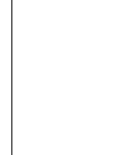
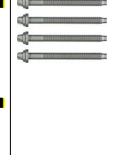
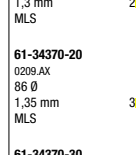
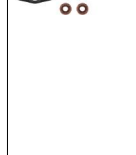
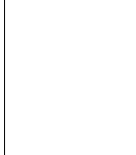
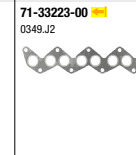
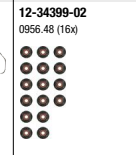
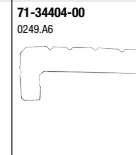
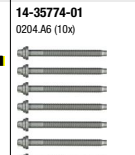
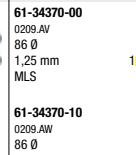
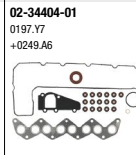
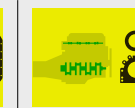
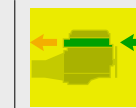

2.2 4HZ (DW12TED4) 100 kW (136 PS)

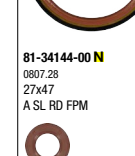
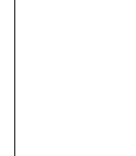
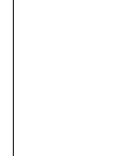
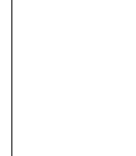
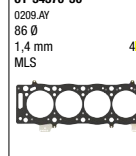
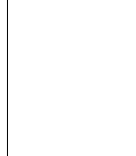
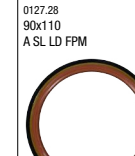
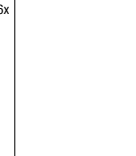
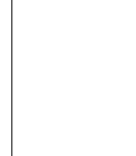
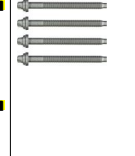
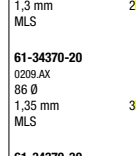
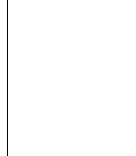
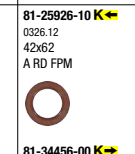
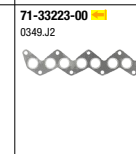
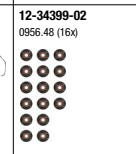
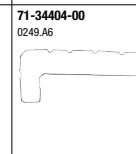
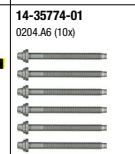
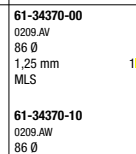
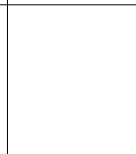
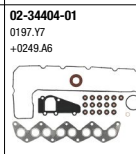



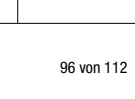
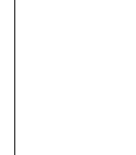
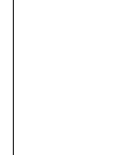
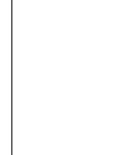
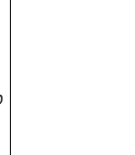
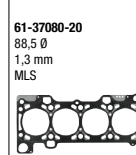
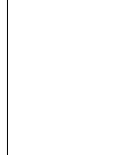
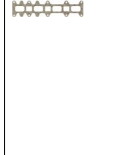
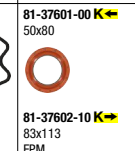
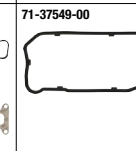
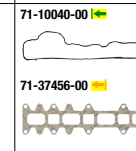
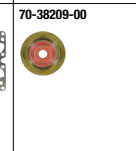
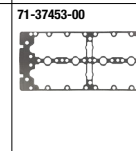
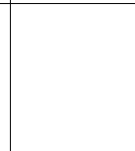
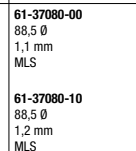
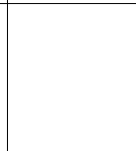
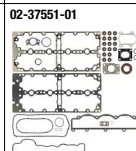























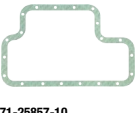
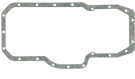



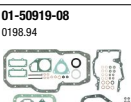
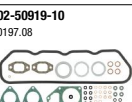

















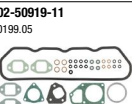























2.3 F1AE0481T 93 kW (126 PS) BOXER HDI 04/06



























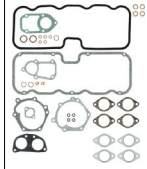

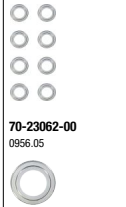

PEUGEOT





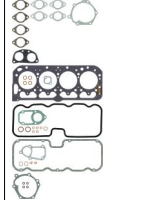





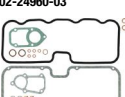

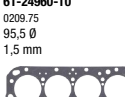
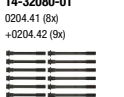
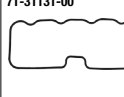



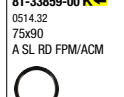
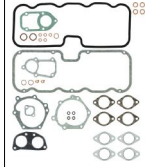

Ltr.	Model	Power	Engine	Year	Part 1	Part 2	Part 3	Part 4	Part 5	Part 6	Part 7	Part 8	Part 9	Part 10	Part 11
2,3	XD2 ( 134)	51 kW (69 PS)	504 D	07/75-12/89	<b>01-50919-08</b> 0198.94 	<b>02-50919-10</b> 0197.08 			<b>61-26630-30</b> 0209.C2 96 Ø 1,5 mm 2  <b>61-26630-40</b> 0209.C4 96 Ø 1,6 mm 4  <b>61-26630-50</b> 0209.D6 96 Ø 1,7 mm 5  	<b>14-32082-01</b> 0204.54 (8x) +0204.55 (7x) +0204.56 (7x)   <b>14-32083-01</b> 0204.55 (15x) +0204.56 (7x)  	<b>71-50919-10</b> 0249.25 	<b>12-77023-01</b> 0956.01 (8x)  <b>40-77023-00</b> 0956.01 8x 	<b>71-25852-20</b>  2x 0349.44  <b>71-50920-10</b>  2x 0349.08  <b>71-24581-10</b>  08 1710.19 	<b>71-22668-10</b> 0304.12  <b>71-25857-10</b> 0313.19 	<b>81-51051-20</b>  0514.35 45x60 A SL RD FPM  <b>71-25853-10</b>  2x 0119.03 
2,3	XD2PX94 XD2P94	49 kW (67 PS)	J7 Bus D J7 D J9 Bus D J9 D	07/77-07/82	<b>01-50919-08</b> 0198.94 	<b>02-50919-10</b> 0197.08 			<b>61-26630-30</b> 0209.C2 96 Ø 1,5 mm 2  <b>61-26630-40</b> 0209.C4 96 Ø 1,6 mm 4  <b>61-26630-50</b> 0209.D6 96 Ø 1,7 mm 5  	<b>14-32082-01</b> 0204.54 (8x) +0204.55 (7x) +0204.56 (7x)   <b>14-32083-01</b> 0204.55 (15x) +0204.56 (7x)  	<b>71-50919-10</b> 0249.25 	<b>12-77023-01</b> 0956.01 (8x)  <b>40-77023-00</b> 0956.01 8x 	<b>71-50920-10</b>  2x 0349.08  <b>40-83824-40</b>  16 1710.15 	<b>71-25857-10</b> 0313.19 	<b>81-51051-20</b>  0514.35 45x60 A SL RD FPM  <b>71-25853-10</b>  2x 0119.03 
2,3	XD2S XD2S (147)	59 kW (80 PS)	505 D 505 TD 604 TD	09/79		<b>02-50919-11</b> 0199.05 			<b>61-26630-30</b> 0209.C2 96 Ø 1,5 mm 2  <b>61-26630-40</b> 0209.C4 96 Ø 1,6 mm 4  <b>61-26630-50</b> 0209.D6 96 Ø 1,7 mm 5  	<b>14-32082-01</b> 0204.54 (8x) +0204.55 (7x) +0204.56 (7x)   <b>14-32083-01</b> 0204.55 (15x) +0204.56 (7x)  	<b>71-50919-10</b> 0249.25 	<b>12-77023-01</b> 0956.01 (8x)  <b>40-77023-00</b> 0956.01 8x 	<b>71-25496-10</b>  3x 0348.52  <b>71-25712-10</b>  2x 0349.34 	<b>71-25857-10</b> 0313.19 	<b>81-51051-20</b>  0514.35 45x60 A SL RD FPM 
2,4	SFY (4B12-MMC) SFZ (4B12-MMC)	125 kW (170 PS)	4007 16V	02/07-03/13	<b>01-10239-01</b> 0197.CA 				<b>61-10239-00</b> 0209.FN 89 Ø 0,5 mm MLS 	<b>14-12679-01</b> 0204.E3 (8x) +0204.E2 (2x)  	<b>71-54092-00</b> 0249.F9 	<b>12-54093-01</b> 0956.61 (16x)  <b>70-54093-00</b> 70-54093-00 16x 	<b>71-25494-00</b>  4x 0348.V9  <b>71-54096-00</b>  0349.N1 	<b>70-31414-10</b> 	<b>81-54097-00</b>  0127.57 42x65 A SL RD FPM  <b>81-54098-00</b>  0127.51 85x103 A SL LD FPM 

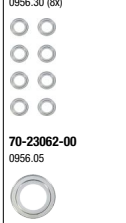





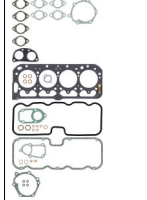









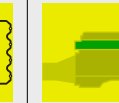
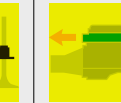
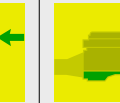



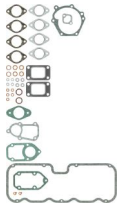

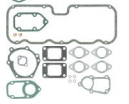
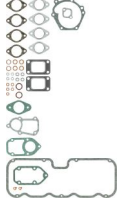

















**PEUGEOT**

Ltr. 		
2,5 CRD93	54 kW (73 PS)	09/81-03/94
	J5 J5 Bus D J5 D	<b>1</b>

										
	<b>02-24960-03</b> 0209.75 95,5 Ø 1,5 mm 			<b>61-24960-10</b> 0209.75 95,5 Ø 1,5 mm 	<b>14-32080-01</b> 0204.41 (8x) +0204.42 (8x) 	<b>71-25612-20</b> 0249.45 	<b>12-23062-01</b> 0956.30 (8x) 	<b>50-92221-20</b>  4x 0348.H0  <b>71-25639-10</b>  4x 0349.F0 		<b>81-33859-00</b>  0514.32 75x90 A SL RD FPM/ACM 
	<b>02-24960-04</b> 0197.K1 +0209.L5 						<b>70-23062-00</b> 0956.05 	8x		

2,5 CRD93L	70 kW (95 PS)	09/81-01/94
	J5 J5 Bus DT J5 DT	

										
	<b>02-24960-03</b> 0209.75 95,5 Ø 1,5 mm 			<b>61-24960-10</b> 0209.75 95,5 Ø 1,5 mm 	<b>14-32080-01</b> 0204.41 (8x) +0204.42 (8x) 	<b>71-31131-00</b> 	<b>12-23062-01</b> 0956.30 (8x) 	<b>50-92221-20</b>  4x 0348.H0  <b>71-25639-10</b>  4x 0349.F0 		<b>81-33859-00</b>  0514.32 75x90 A SL RD FPM/ACM 
	<b>02-24960-04</b> 0197.K1 +0209.L5 						<b>70-23062-00</b> 0956.05 	8x		

PEUGEOT														
Ltr. 														
2,5 CRD93LS	70 kW (95 PS)	J5 Bus TD J5 TD	10/90-02/94		<p><b>02-24960-02</b></p>  <p><b>02-27015-01</b> 0197.R9 +0209.L6</p>  									
2,5 CRD93LS	70 kW (95 PS)	J5 DT	09/81-08/90		<p><b>02-24960-02</b></p>  <p><b>02-27015-01</b> 0197.R9 +0209.L6</p>  									
								<p><b>61-27015-10</b> 0209.L6 95,5 Ø 1,7 mm</p> 	<p><b>14-32080-01</b> 0204.41 (8x) +0204.42 (8x)</p> 	<p><b>71-25612-20</b> 0249.45</p> 	<p><b>12-23062-03</b></p>  <p><b>70-20423-00 AS</b> 4x</p>  <p><b>70-23062-00 ES</b> 4x</p> 	<p><b>50-92221-20</b>  4x 0348.H0</p>  <p><b>71-25639-10</b>  4x 0349.F0</p> 	<p><b>81-33859-00</b>   0514.32 75x90 A SL RD FPM/ACM</p> 	
								<p><b>61-27015-10</b> 0209.L6 95,5 Ø 1,7 mm</p> 	<p><b>14-32080-01</b> 0204.41 (8x) +0204.42 (8x)</p> 	<p><b>71-25612-20</b> 0249.45</p> 	<p><b>12-23062-03</b></p>  <p><b>70-20423-00</b> 4x</p>  <p><b>70-23062-00</b> 4x</p> 	<p><b>50-92221-20</b>  4x 0348.H0</p>  <p><b>71-25639-10</b>  4x 0349.F0</p> 	<p><b>81-33859-00</b>   0514.32 75x90 A SL RD FPM/ACM</p> 	

PEUGEOT

Ltr.  2,5 DJ5 (T9A) 63-95 kW (86-129 PS) BOXER Bus D BOXER D 605 TD  03/94-04/02



**01-29160-01**  
0197.17  
+0209.R3



**02-29160-01**  
0197.76  
+0209.R3

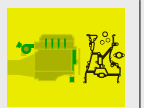

**61-29160-00**  
0209.R3  
93 Ø  
1,6 mm

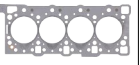

**14-32164-01**  
0204.74 (14x)  
+0204.75 (8x)



**71-33723-00**  
0249.79



**12-26058-01**  
0956.19 (12x)

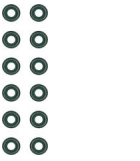

**70-26058-00**  
0956.19

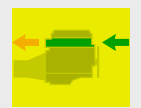

**71-33687-00**   
0348.K1



**71-33786-00**   
0348.F9



**71-33688-00**   
0349.E7



**70-31414-10**



**81-34457-00**   
0326.25  
64x88  
A SL RD FPM/ACM



**81-34458-00**   
0119.14  
98x120  
A SL LD FPM/ACM



**81-25451-10**   
0807.14  
35x50  
A SL RD FPM



**81-34142-00**   
0807.21  
47,5x62  
A SL LD FPM/ACM



**81-34143-00**   
0807.15  
40x62  
A SL LD FPM/ACM



PEUGEOT

Ltr.  2,5 DJ5T (T8A) 76 kW (103 PS) BOXER Bus TD BOXER TD 03/94-04/02  1

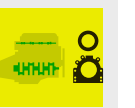
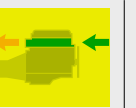

01-29160-01  
0197.T7  
+0209.R3



02-29160-01  
0197.T6  
+0209.R3



04-10204-01 

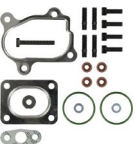

61-29160-00  
0209.R3  
93 Ø  
1,6 mm

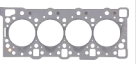

14-32164-01  
0204.74 (14x)  
+0204.75 (8x)



71-33723-00  
0249.79



12-26058-01  
0956.19 (12x)

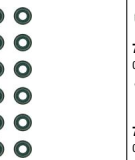

70-26058-00  
0956.19



71-33687-00   
0348.K1



71-33786-00    
0348.F9



71-33688-00   
0349.E7



70-31414-10 



81-34457-00   
0326.25  
64x88  
A SL RD FPM/ACM



81-34458-00   
0119.14  
98x120  
A SL LD FPM/ACM



81-25451-10   
0807.14  
35x50  
A SL RD FPM



81-34142-00    
0807.21  
47,5x62  
A SL LD FPM/ACM



81-34143-00    
0807.15  
40x62  
A SL LD FPM/ACM



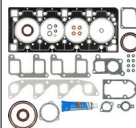

2,5 DJ5TD (THX) 79 kW (107 PS) BOXER Bus TDI BOXER TDI 01/97-04/02

01-34110-01  
0197.W4  
+0209.T5

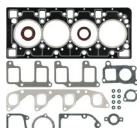

02-34110-01  
0197.W3  
+0209.T5



04-10204-01 



61-34110-00  
0209.T5  
93 Ø  
1,35 mm  
MLS

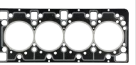

14-32156-01  
0204.87 (14x)  
+0204.88 (8x)



71-33723-00  
0249.79



12-26058-02  
0956.19 (8x)

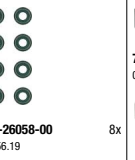

70-26058-00  
0956.19



71-37096-00   
0348.K4



71-37097-00   
0349.G4



70-31414-10 



81-34457-00   
0326.25  
64x88  
A SL RD FPM/ACM



81-34458-00   
0119.14  
98x120  
A SL LD FPM/ACM































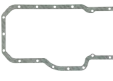





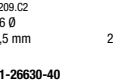









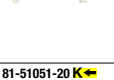
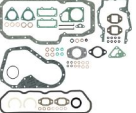

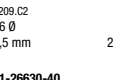





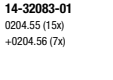
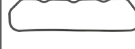
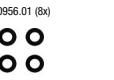





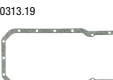

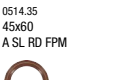



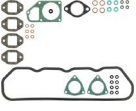
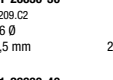





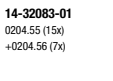

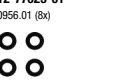
81-25451-10   
0807.14  
35x50  
A SL RD FPM





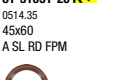































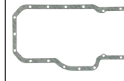









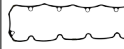











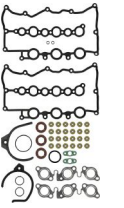





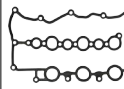
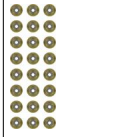

81-17110-20   
0807.26  
32x52  
A SL LD FPM/ACM



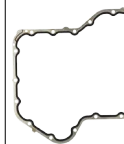



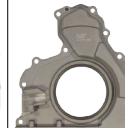













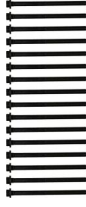



















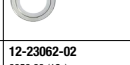



PEUGEOT

<p>Ltr.  2,5 EN 55  53-56 kW (72-76 PS)  1</p>					 <p>61-26630-30 0209.C2 96 Ø 1,5 mm <b>2</b> </p> <p>61-26630-40 0209.C4 96 Ø 1,6 mm <b>4</b> </p> <p>61-26630-50 0209.D6 96 Ø 1,7 mm <b>5</b> </p> 			 <p>12-77023-01 0956.01 (8x)</p>  <p>40-77023-00 0956.01</p>  <p>8x</p>		 <p>71-25857-10 0313.19</p> 	 <p>81-51051-20 <b>K</b> </p> <p>0514.35 45x60 A SL RD FPM</p>  <p>71-25853-10 <b>K</b>  2x</p> <p>0119.03</p> 
<p>2,5 ET 70 71 kW (96 PS)</p>					 <p>61-26630-30 0209.C2 96 Ø 1,5 mm <b>2</b> </p> <p>61-26630-40 0209.C4 96 Ø 1,6 mm <b>4</b> </p> <p>61-26630-50 0209.D6 96 Ø 1,7 mm <b>5</b> </p> 			 <p>12-77023-01 0956.01 (8x)</p>  <p>40-77023-00 0956.01</p> <p>8x</p>			 <p>81-51051-20 <b>K</b> </p> <p>0514.35 45x60 A SL RD FPM</p>  <p>71-25853-10 <b>K</b>  2x</p> <p>0119.03</p> 
<p>2,5 XD3 (155) 51-55 kW (69-75 PS) 505 D 06/81-12/93</p>	<p>01-50919-06 0197.P0</p> 	<p>02-50919-09 0197.N9</p> 			 <p>61-26630-30 0209.C2 96 Ø 1,5 mm <b>2</b> </p> <p>61-26630-40 0209.C4 96 Ø 1,6 mm <b>4</b> </p> <p>61-26630-50 0209.D6 96 Ø 1,7 mm <b>5</b> </p> 	<p>14-32082-01 0204.54 (8x) +0204.55 (7x) +0204.56 (7x)</p>  <p>14-32083-01 0204.55 (15x) +0204.56 (7x)</p> 	<p>71-50919-10 0249.25</p> 	 <p>12-77023-01 0956.01 (8x)</p>  <p>40-77023-00 0956.01</p> <p>8x</p>	<p>71-25852-20  2x</p> <p>0349.44</p>  <p>50-92232-00  10</p> <p>1710.34</p> 	 <p>71-25857-10 0313.19</p> 	 <p>81-51051-20 <b>K</b> </p> <p>0514.35 45x60 A SL RD FPM</p>  <p>71-25853-10 <b>K</b>  2x</p> <p>0119.03</p> 
<p>2,5 XD3P 53-55 kW (72-75 PS) J9 Bus D J9 D 504 07/82-10/99</p>		<p>02-50919-09 0197.N9</p> 			 <p>61-26630-30 0209.C2 96 Ø 1,5 mm <b>2</b> </p> <p>61-26630-40 0209.C4 96 Ø 1,6 mm <b>4</b> </p> <p>61-26630-50 0209.D6 96 Ø 1,7 mm <b>5</b> </p> 	<p>14-32082-01 0204.54 (8x) +0204.55 (7x) +0204.56 (7x)</p>  <p>14-32083-01 0204.55 (15x) +0204.56 (7x)</p> 	<p>71-50919-10 0249.25</p> 	 <p>12-77023-01 0956.01 (8x)</p>  <p>40-77023-00 0956.01</p> <p>8x</p>	<p>71-25852-20  2x</p> <p>0349.44</p> 	 <p>70-31414-10</p> 	 <p>81-51051-20 <b>K</b> </p> <p>0514.35 45x60 A SL RD FPM</p>  <p>71-25853-10 <b>K</b>  2x</p> <p>0119.03</p> 

PEUGEOT

<p>Ltr.   </p> <p>2,5 XD3T XD3T (152A) XD3TE XD3TE (152B)</p> <p>66-81 kW (90-110 PS)</p> <p>505 D 505 TD 604 TD</p> <p>08/83</p>		 <p><b>02-50919-11</b> 0199.05</p> 			 <p><b>61-26630-30</b> 0209.C2 96 Ø 1,5 mm <b>2</b> </p> <p><b>61-26630-40</b> 0209.C4 96 Ø 1,6 mm <b>4</b> </p> <p><b>61-26630-50</b> 0209.D6 96 Ø 1,7 mm <b>5</b> </p> 	<p><b>14-32082-01</b> 0204.54 (8x) +0204.55 (7x) +0204.56 (7x)</p>  <p><b>14-32083-01</b> 0204.55 (15x) +0204.56 (7x)</p>	<p><b>71-50919-10</b> 0249.25</p> 	<p><b>12-77023-01</b> 0956.01 (8x)</p>  <p><b>40-77023-00</b> 0956.01</p> 	<p><b>71-25496-10</b>  <b>3x</b></p> <p>0348.52</p>  <p><b>71-31123-00</b>  <b>2x</b></p> <p>0348.A3</p>  <p><b>71-25712-10</b>  <b>2x</b></p> <p>0349.34</p>  <p><b>40-83826-10</b>  <b>16</b></p> <p>1710.27</p>	<p><b>71-25857-10</b> 0313.19</p> 	<p><b>81-51051-20</b>  <b>K</b></p> <p>0514.35 45x60 A SL RD FPM</p>  <p><b>71-25853-10</b>  <b>K</b> <b>2x</b></p> <p>0119.03</p> 
<p>2,5 8140.67</p> <p>62 kW (84 PS)</p> <p>BOXER</p> <p>10/97-11/01</p>		<p><b>02-33951-08</b></p> 	<p><b>04-10002-01</b> </p> 	<p><b>61-33610-00</b> 95,2 Ø 1,65 mm</p> <p><b>61-33610-10</b> 95,2 Ø 1,7 mm</p> <p><b>61-33610-20</b> 95,2 Ø 1,8 mm</p> 	<p><b>14-32096-01</b></p> 	<p><b>71-33951-10</b> 0249.A0</p> 	<p><b>12-34914-05</b> 0956.44 (8x)</p>  <p><b>70-34914-00</b> 0956.44</p> 	<p><b>71-33621-00</b>  <b>4x</b></p> <p>0348.N5</p>  <p><b>71-33654-00</b>  <b>4x</b></p> <p>0349.H5</p>  <p><b>71-33958-00</b> </p> 	<p><b>71-83048-00</b> 0304.54</p> 	<p><b>81-33623-00</b>  <b>K</b></p> <p>70x90 A SL RD FPM</p> 	
<p>2,7 DT17BTEd4 (UHZ) DT17TEd4 UHZ (DT17TEd4)</p> <p>150 kW (204 PS)</p> <p>407 HDI 607 HDI 24V</p> <p>12/04</p>		<p><b>02-38558-01</b></p> 	<p><b>08-38527-01</b></p> 	<p><b>61-34875-10</b> <b>2x</b> 0209.DW 82,5 Ø 1,17 mm MLS <b>2</b> </p> <p><b>61-34875-20</b> <b>2x</b> 0209.CX 82,5 Ø 1,22 mm MLS <b>3</b> </p> <p><b>61-34875-30</b> <b>2x</b> 0209.CY 82,5 Ø 1,27 mm MLS <b>4</b> </p> <p><b>61-34875-40</b> <b>2x</b> 0209.CZ 82,5 Ø 1,32 mm MLS <b>5</b> </p> 	<p><b>14-32344-01</b> 0204.A8 (8x) <b>2x</b></p> 	<p><b>71-38558-00</b> <b>2x</b> 0249.E1</p> 	<p><b>12-38546-01</b> 0956.53 (24x)</p>  <p><b>70-38546-00</b> <b>24x</b> 0956.53</p> 	<p><b>71-34888-00</b>  <b>2x</b></p> <p>0349.L0</p> 	<p><b>71-38527-00</b> 0164.75</p>  <p><b>71-41252-00</b> 0304.57</p> 	<p><b>81-34316-00</b>  <b>K</b></p> <p>0326.29 35x50 A SL RD PTFE ACM</p>  <p><b>81-90050-00</b>  <b>K</b></p> <p>0514.C0</p>  <p><b>81-38536-00</b>  <b>N</b> <b>3x</b></p> <p>0807.36 26x45 A SL WD FPM</p> 	

PEUGEOT

<p>Ltr.  2.7 ZM (112) 100 kW (136 PS) 604  08/77-05/83</p>					<p><b>61-23575-10 R</b> 0203.67 90 Ø 1,2 mm</p>  <p><b>61-23576-10 L</b> 0203.66 90 Ø 1,2 mm</p> 	<p><b>14-32084-01</b> 0204.53 (16x)</p> 	<p><b>71-24562-00 R 22</b> 0249.30</p>  <p><b>71-24563-00 L 22</b> 0249.29</p>  <p><b>71-25260-10 L 28</b> 0249.37</p>  <p><b>71-25261-10 R 28</b> 0249.31</p> 	<p><b>12-23062-02</b> 0956.30 (12x)</p>   <p><b>70-23062-00</b> 0956.05</p> 	<p><b>71-24564-00 L 22</b> 0348.24</p>  <p><b>71-24566-00 L 22</b> 0348.25</p>  <p><b>71-24567-10</b> 0349.88</p> 	<p><b>71-25254-10 10</b> 0123.19</p> 	<p><b>81-21001-10 K 22</b> 0514.21 42x62 A SL RD ACM</p>  <p><b>81-18304-00 K 22</b> 0514.20 80x100 A LD MVQ</p> 
<p>2.7 ZMJ (140) 106 kW (144 PS) 504 604 08/77-08/84</p>					<p><b>61-23575-10 R</b> 0203.67 90 Ø 1,2 mm</p>  <p><b>61-23576-10 L</b> 0203.66 90 Ø 1,2 mm</p> 	<p><b>14-32084-01</b> 0204.53 (16x)</p> 	<p><b>71-25260-10 L</b> 0249.37</p>  <p><b>71-25261-10 R</b> 0249.31</p> 	<p><b>12-23062-02</b> 0956.30 (12x)</p>   <p><b>70-23062-00</b> 0956.05</p> 	<p><b>40-76752-00 L 22</b> 0348.43</p>  <p><b>71-24567-10</b> 0349.88</p> 	<p><b>71-25254-10 10</b> 0123.19</p> 	<p><b>81-21001-10 K 22</b> 0514.21 42x62 A SL RD ACM</p>  <p><b>81-18304-00 K 22</b> 0514.20 80x100 A LD MVQ</p> 
<p>2.8 ZN3J (154X) 105-124 kW (143-169 PS) 505 505 GTI V6 604 01/77-12/93</p>					<p><b>61-24515-20 L</b> 0209.39 93 Ø 1,5 mm</p>  <p><b>61-24516-20 R</b> 0209.41 93 Ø 1,5 mm</p> 	<p><b>14-32084-01</b> 0204.53 (16x)</p> 		<p><b>12-23062-02</b> 0956.30 (12x)</p>   <p><b>70-23062-00</b> 0956.05</p> 	<p><b>40-76752-00 L 22</b> 0348.43</p>  <p><b>71-24567-10</b> 0349.88</p> 	<p><b>71-25254-10 10</b> 0123.19</p> 	



PEUGEOT														
Ltr.														
2,8 8140.43	90 kW (122 PS)	BOXER BOXER HDI	10/97-08/05	<b>01-33951-10</b> 0197.Y2 	<b>02-33951-10</b> 		<b>04-10047-01</b> 	<b>61-33950-00</b> 0209.DC 1,3 mm <b>61-33950-10</b> 0209.OE 1,4 mm <b>61-33950-20</b> 0209.OF 1,5 mm 		<b>71-33951-10</b> 0249.A0  <b>71-33956-00</b> 0249.C3 	<b>12-34914-05</b> 0956.44 (8x)  <b>70-34914-00</b> 0956.44 	<b>71-33621-00</b> 0348.N5 4x <b>71-33654-00</b> 0349.H5 4x 	<b>71-33944-10</b>  <b>71-83048-00</b> 0304.54 	
2,8 8140.43 (F28DT)	90 kW (122 PS)	BOXER Bus BOXER D BOXER TD	10/97-03/05	<b>01-33951-07</b> 	<b>02-33951-07</b> 			<b>61-33950-00</b> 0209.DC 1,3 mm <b>61-33950-10</b> 0209.OE 1,4 mm <b>61-33950-20</b> 0209.OF 1,5 mm 	<b>14-32096-01</b> 	<b>71-33951-10</b> 0249.A0 	<b>12-34914-05</b> 0956.44 (8x)  <b>70-34914-00</b> 0956.44 	<b>71-33621-00</b> 0348.N5 4x <b>71-33654-00</b> 0349.H5 4x 	<b>71-34049-10</b> 	
2,8 8140.43N	107 kW (145-146 PS)	BOXER HDI	04/04-06/06	<b>01-33956-06</b> 0197.Z4 	<b>02-33956-04</b> 0197.Z0 		<b>04-10232-01</b> 	<b>61-33950-00</b> 0209.DC 1,3 mm <b>61-33950-10</b> 0209.OE 1,4 mm <b>61-33950-20</b> 0209.OF 1,5 mm 		<b>71-33956-00</b> 0249.C3 	<b>12-34914-05</b> 0956.44 (8x)  <b>70-34914-00</b> 0956.44 	<b>71-33621-00</b> 0348.N5 4x <b>71-33654-00</b> 0349.H5 4x 	<b>71-33944-10</b>  <b>71-83048-00</b> 0304.54 	<b>81-10173-00</b> 0514.C1 FPM  <b>81-90042-00</b> 0514.A8 FPM  <b>81-33627-00</b> 55x70 A SL RD FPM 
2,8 8140.43S 8140.43S (F28DTCR)	93-94 kW (126-128 PS)	BOXER Bus BOXER Bus HDI BOXER HDI	10/00-09/09	<b>01-33951-10</b> 0197.Y2 	<b>02-33951-10</b> 		<b>04-10047-01</b> 	<b>61-33950-00</b> 0209.DC 1,3 mm <b>61-33950-10</b> 0209.OE 1,4 mm <b>61-33950-20</b> 0209.OF 1,5 mm 		<b>71-33951-10</b> 0249.A0  <b>71-33956-00</b> 0249.C3 	<b>12-34914-05</b> 0956.44 (8x)  <b>70-34914-00</b> 0956.44 	<b>71-33621-00</b> 0348.N5 4x <b>71-33654-00</b> 0349.H5 4x 	<b>71-33944-10</b>  <b>71-83048-00</b> 0304.54 	

PEUGEOT

Ltr. 2,8 8140.63 (F28D) 64 kW (87 PS) BOXER D 01/99-02/02



01-33956-06  
0197.Z4

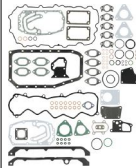

02-33956-04  
0197.Z0



61-33950-00  
0209.DC  
1,3 mm

61-33950-10  
0209.OE  
1,4 mm

61-33950-20  
0209.OF  
1,5 mm

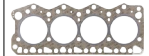

71-33956-00  
0249.C3

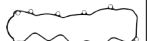

12-34914-05  
0956.44 (8x)

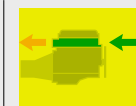

71-33621-00 4x  
0348.N5



71-33654-00 4x  
0349.H5

8x



71-33944-10

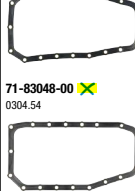

81-10173-00   
0514.C1  
FPM



81-90042-00   
0514.A8  
FPM



81-33627-00   
55x70  
A SL RD FPM



3,0 DT20C 177 kW (241 PS) 407 HDI 06/09



61-36610-00 2x  
0209.GX  
85 Ø  
1,17 mm  
MLS

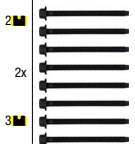

61-36610-10 2x  
0209.GY  
85 Ø  
1,22 mm  
MLS

61-36610-20 2x  
0209.GZ  
85 Ø  
1,27 mm  
MLS

61-36610-30 2x  
0209.HA  
85 Ø  
1,32 mm  
MLS

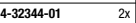

14-32344-01 2x  
0204.A8 (8X)

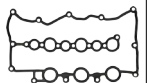

71-38558-00 2x  
0249.E1



12-38546-01  
0956.53 (24x)



70-38546-00  
0956.53

24x

71-34888-00 2x  
0349.L0



71-38527-00  
0164.75



71-41252-00  
0304.57

81-34316-00   
0326.29  
35x50  
A SL RD PTFE ACM





81-90050-00   
0514.C0



81-38536-00   
0807.36  
26x45  
A SL WD FPM



PEUGEOT

Ltr.  3,0 ES9A (XFV)  155-158 kW (211-215 PS)  1 03/04

407  
407 SW  
407 V6  
607 V6 24V

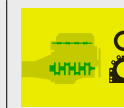

**61-36510-00 L**  
0209.OX  
89 Ø  
0,74 mm  
MLS

**61-36510-10 L**  
0209.OZ  
89 Ø  
0,95 mm  
MLS



**61-36515-00 R**  
0209.OY  
89 Ø  
0,74 mm  
MLS

**61-36515-10 R**  
0209.1A  
89 Ø  
0,95 mm  
MLS



**70-31414-10**  

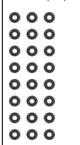

**12-31306-05**  
0956.38 (24x)



**70-31306-00**  
0956.64



**71-38551-00 L**   
0348.00



**71-38556-00 L**  2x  
0348.P9





**71-38541-00**  2x  
0349.G0



**70-31414-10**  



**81-38529-00 K**   
0514.A9  
42x56  
A SL RD PTFE  
(Polytetrafluorethylen)/ACM  
(Polyacryl-Kautschuk)



**81-38528-00 K**   
0119.18  
98x120  
A SL LD PTFE  
(Polytetrafluorethylen)/ACM  
(Polyacryl-Kautschuk)



**81-38531-00 N** 4x  
0807.34  
38x50  
A SL RD PTFE  
(Polytetrafluorethylen)/ACM  
(Polyacryl-Kautschuk)



3,0 ES9J4 (XFZ) 140-143 kW (190-194 PS) 01/92-12/04

406  
406 COUPE  
406 V6 24V  
605  
605 V6

**02-36530-01 R**  
 0008570→



**02-36525-01 L**  
 0008570→



**08-34458-01**



**61-36525-00 L**  
0209.ON  
89 Ø  
1,45 mm  
MLS  
 0008570→



**61-36530-00 R**  
0209.OP  
89 Ø  
1,45 mm  
MLS  
 0008570→



**70-31414-10**  

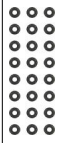

**12-31306-05**  
0956.38 (24x)



**70-31306-00**  
0956.64



**71-38596-00 L**  2x  
0348.L5



**71-38594-00 L**   2x  
0348.K7





**71-38541-00**  2x  
0349.G0



**70-31414-10**  



**81-51109-30 K**   
0514.82  
42x56  
A SL RD FPM



**81-34458-00 K**   
0119.14  
98x120  
A SL LD FPM/ACM



**81-34146-00 N** 4x  
0807.24  
38x50  
A SL RD FPM



PEUGEOT

Ltr. 3,0 ES9J4S (XFX) 150-155 kW (204-211 PS) 406 406 COUPE 406 V6 24V 607 V6 24V 807 V6 24V 03/99

3,0 F1CE0481D (FG30DT) 115-116 kW (156-158 PS) BOXER Bus HDI 01/15

01-36885-01  
0197.AR

01-38371-02

02-36885-01  
0197.AQ

02-38371-02

08-34458-01  
10086

08-38528-01  
10087→

61-36885-00  
0209.FJ  
1,1 mm  
MLS

61-36885-10  
1,2 mm  
MLS

61-36885-20  
1,3 mm  
MLS

14-32359-01  
0204.C6 (6x)  
+0204.C7 (4x)  
+0204.C8 (4x)  
+0204.C9 (1x)

71-38371-00  
0249.F7

12-37553-01  
0951.61 (16x)

70-37553-00  
0951.61

71-38349-00  
0348.T7

71-38362-00  
0349.L8

71-38202-00  
0304.59

81-38091-00  
0514.C9  
50x70  
PTFE

81-38089-00  
0514.E4  
90x120  
FPM

81-51109-30  
0514.82  
42x56  
A SL RD FPM  
10086

81-38529-00  
0514.A9  
42x56  
A SL RD PTFE  
(Polytetrafluorethylen)/ACM  
(Polyacryl-Kautschuk)  
10087→



81-34458-00  
0119.14  
98x120  
A SL LD FPM/ACM  
10086





















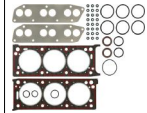
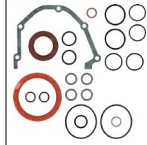

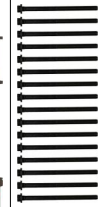



81-38528-00  
0119.18  
98x120  
A SL LD PTFE  
(Polytetrafluorethylen)/ACM  
(Polyacryl-Kautschuk)  
10087→

81-34146-00  
0807.24  
38x50  
A SL RD FPM

PEUGEOT															
3,0	F1CE0481D (F30DT)	115-116 kW (156 PS)	BOXER HDI BOXER HDI 160	04/06	<b>01-36885-01</b> 0197.AR 	<b>02-36885-01</b> 0197.AQ 		<b>04-10319-01</b> 	<b>61-36885-00</b> 0209.FJ 1,1 mm MLS  <b>61-36885-10</b> 1,2 mm MLS  <b>61-36885-20</b> 1,3 mm MLS 	<b>14-32359-01</b> 0204.C6 (6x) +0204.C7 (4x) +0204.C8 (4x) +0204.C9 (1x) 	<b>71-38371-00</b> 0249.F7 	<b>12-37553-01</b> 0951.61 (16x)   <b>70-37553-00</b> 0951.61 16x 	<b>71-38349-00</b> 0348.T7   <b>71-38362-00</b> 0349.L8 	<b>71-38202-00</b> 0304.59 	<b>81-38091-00</b> 0514.C9 50x70 PTFE   <b>81-38089-00</b> 0514.E4 90x120 FPM 
3,0	F1CE3481E (F30DTE) F1CE3481N (F30DTE)	107-130 kW (146-177 PS)	BOXER HDI 145 BOXER HDI 175	04/10	<b>01-36885-03</b> 0197.CG 	<b>02-36885-03</b> 0197.CF 			<b>61-36885-00</b> 0209.FJ 1,1 mm MLS  <b>61-36885-10</b> 1,2 mm MLS  <b>61-36885-20</b> 1,3 mm MLS 	<b>14-32359-01</b> 0204.C6 (6x) +0204.C7 (4x) +0204.C8 (4x) +0204.C9 (1x) 	<b>71-38371-00</b> 0249.F7 	<b>12-37553-01</b> 0951.61 (16x)   <b>70-37553-00</b> 0951.61 16x 	<b>71-38349-00</b> 0348.T7   <b>71-38362-00</b> 0349.L8 	<b>71-38202-00</b> 0304.59 	<b>81-38091-00</b> 0514.C9 50x70 PTFE   <b>81-38089-00</b> 0514.E4 90x120 FPM 
3,0	ZPJ (UFZ)	123-127 kW (167-173 PS)	605	08/89-09/99		<b>02-33615-02</b> 0197.E1 +0209.A4 +0209.A5 +0956.30 (12x) 	<b>08-33679-01</b> 		<b>61-33615-00 R</b> 0209.A4 95,2 Ø 1,7 mm   <b>61-33620-00 L</b> 0209.A5 95,2 Ø 1,7 mm 	<b>14-32084-01</b> 0204.53 (16x) 	<b>70-31414-10</b> 	<b>12-25837-03</b> 0956.22 (12x)   <b>70-25837-00</b> 0956.22 12x 	<b>40-76752-00</b> 0348.A3   <b>71-28604-00</b> 96 130 969 6x 	<b>70-31414-10</b> 	<b>81-25926-10</b> 0326.12 42x62 A RD FPM   <b>81-18304-00</b> 0514.20 80x100 A LD MVQ   <b>81-22660-00 N</b> 0236.24 32x45 A LD FPM 

PEUGEOT

Ltr.  3,0 ZPJ4 (UKZ) 147 kW (200 PS) 605 605 SV 24  08/89-09/99

										
	<p><b>02-33615-03</b> 0197.E3 +0209.A4 +0209.A5 +0956.24 (24x)</p> 	<p><b>08-33679-01</b></p> 		<p><b>61-33615-00 R</b> 0209.A4 95,2 Ø 1,7 mm</p>  <p><b>61-33620-00 L</b> 0209.A5 95,2 Ø 1,7 mm</p> 	<p><b>14-32084-01</b> 0204.53 (16x)</p> 	<p><b>70-31414-10</b></p> 	<p><b>12-26058-01</b> 0956.19 (12x)</p>  <p><b>70-26058-00</b> 0956.19</p> 	<p><b>71-33681-00</b>   2x 0349.74</p> 	<p><b>70-31414-10</b></p> 	<p><b>81-25826-10 K</b>  0326.12 42x62 A RD FPM</p>  <p><b>81-18304-00 K</b>  0514.20 80x100 A LD MVQ</p>  <p><b>81-22660-00 N</b>  2x 0236.24 32x45 A LD FPM</p> 

# Haftungsausschluss

## (für Katalog)

**Alle Angaben in unserem Katalog** wurden von uns sorgfältig geprüft, sind jedoch unverbindlich. Ersatzansprüche wegen Katalogangaben werden von uns nicht anerkannt. Der Käufer ist selbst verpflichtet, zu prüfen, ob unsere Teile für seine Zwecke geeignet sind. In allen Zweifelsfällen sollte Rücksprache mit unserem technischen Kundendienst erfolgen **Tel. +49 731 7046 999**.

**Technische Weiterentwicklungen** oder Änderungen bleiben vorbehalten, soweit damit keine Nachteile für den Kunden verbunden sind.

**Angaben, Namens- und Markenzeichen**, Beschreibungen, Nummern von Fahrzeugnummern und Herstellerzeichen, Original-Ersatzteilnummern der Fahrzeug- und Motorenhersteller u. a. sind ausschließlich für interne Zwecke gedacht. Solche Kennzeichnungen dürfen Fahrzeugbesitzern gegenüber nicht verwendet werden.

**Wir weisen ausdrücklich darauf hin**, dass alle von uns gelieferten Teile von geschultem Fachpersonal einzubauen sind. Reinz haftet für Fehler in diesem Katalog nur, wenn diese für den Kunden nicht offenbar erkennbar sind sowie nur bei Vorsatz und grober Fahrlässigkeit von Reinz, eines Vertreters oder eines Erfüllungsgehilfen. Dieser Haftungsausschluss gilt nicht im Rahmen

des Anwendungsbereichs des Produkthaftungsgesetzes und nicht bei Verletzung von Körper, Leben und Gesundheit, sowie bei der Verletzung von sog. Kardinalpflichten. Darüber hinaus ist unsere Haftung für Schäden, insbesondere für Personen-, Sach- oder Vermögensschäden, die unmittelbar oder mittelbar im Zusammenhang mit der Nutzung dieses Kataloges auftreten, sowie für nicht voraussehbare Schäden ausgeschlossen.

**Reinz ist Inhaber aller Schutzrechte** an den in diesem Katalog gespeicherten Daten. Kopie, Nachdruck, ganze oder teilweise Übernahme der Inhalte und Vervielfältigung, auch auszugsweise, ist nur mit unserer vorheriger schriftlicher Zustimmung sowie mit unserem Urheberrechtsvermerk zulässig.

Für Bestellungen, welche ab dem Erscheinungsdatum eines neuen Katalogs getätigt werden, sind alleine die Angaben des neuen Katalogs maßgeblich. Auf Angaben im Vorkatalog kann bei Neubestellungen nicht mehr zurückgegriffen werden.

**Sofern Sie noch Fragen haben, bitten wir Sie, sich mit uns in Verbindung zu setzen.**

VictorReinz.com/AGB

# Exclusion of Liability

## (for catalog)

**All details in our catalog** have been thoroughly checked by us but are however not binding. Right to damages on account of catalog details will not be recognized. The purchaser is obliged to check if our parts are suitable for their use. In all doubtful cases, the purchaser should consult our technical customer service under **+49 731 7046 999**.

**We reserve the right** to further technical developments or changes as long as no disadvantage for the customer results.

**Details, name and trademarks**, descriptions, numbers from vehicle numbers and manufacturer symbols, original vehicle replacement part numbers and engine manufacturer etc. are solely for internal use. Such labels must not be used with vehicle owners.

**We specifically point out** that all parts supplied by us must be assembled by trained specialists.

**Reinz is liable for mistakes** in this catalog only when they are not clearly recognizable for the customer, as well as by intent or gross negligence on the part of Reinz, its representative or vicarious agent. This exclusion of liability does not apply within the framework of the field of

application of the product liability laws and not by bodily harm, life and health, as well as by violation of cardinal duties. In addition, our liability for damages, especially personal, property or financial damages that occur directly or indirectly as a result of the use of this catalog, as well as non-foreseeable damages are excluded.

**Reinz is the owner of all patent rights** on the data stored in this catalog. Copies, reprints, whole or partial takeover of the contents and duplication even in excerpts are only permissible with our prior written approval, as well as with our copyright note.

**For orders placed after the publication date** of a new catalog, only the details in the new catalog are binding and no fall back to details in the previous catalog is possible.

**In case you have further questions, do not hesitate to contact us.**

VictorReinz.com/AGB

**VictorReinz.com**

**reinz.info@dana.com**

**Technical Hotline +49 (0)731 7046-9 99**

**REINZ-Dichtungs-GmbH**

Reinzstrasse 3-7  
89233 Neu-Ulm  
Germany  
+49 (0)731 7046-0

***VICTOR REINZ***<sup>®</sup>

---

