

VICTOR REINZ®

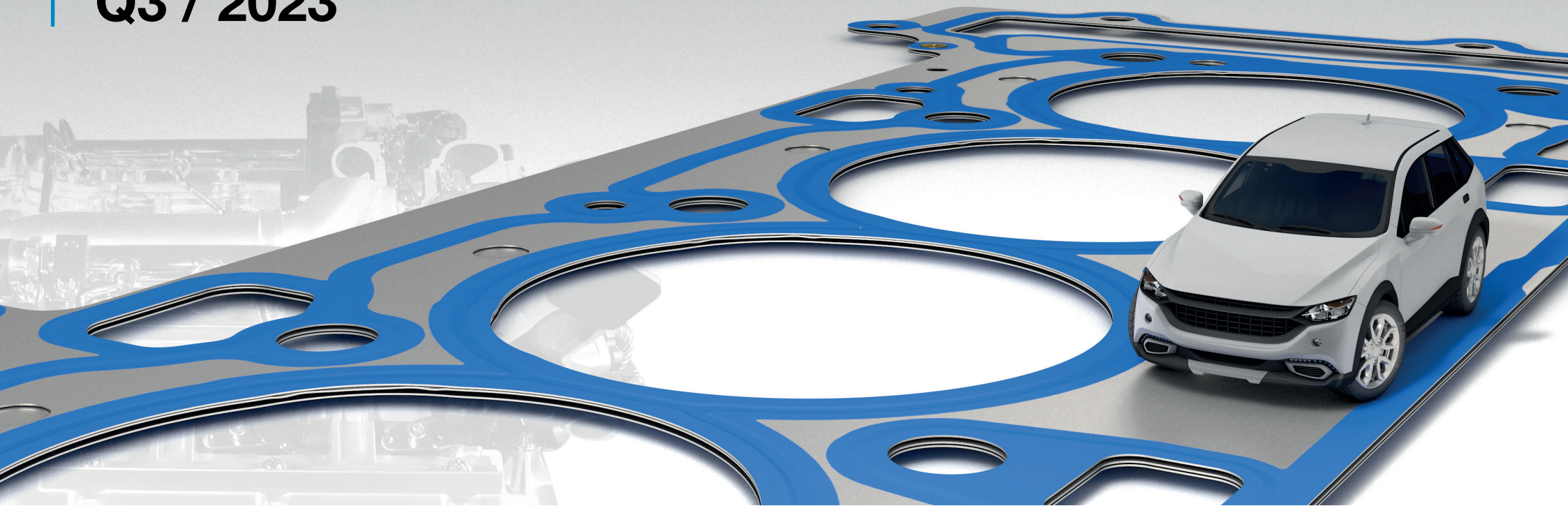

SAAB
Q3 / 2023



VictorReinz.com/online-catalog

Victor Reinz®

at a Glance



Online Catalog

VictorReinz.com/online-catalog



Newsletter

VictorReinz.com/EN/News/Newsletter.aspx?region



Youtube

www.youtube.com/user/VictorReinzSealingEN



Catalog News

VictorReinz.com/news



Technical Service Information

VictorReinz.com/tsi



Facebook

www.facebook.com/VictorReinzParts



Just seal it!

VictorReinz.com/jsi



Technical Datasheet

VictorReinz.com/jsi-datasheet



LinkedIn

www.linkedin.com/showcase/victor-reinz-emea



Safety Datasheet

VictorReinz.com/jsi-datasheet



Homepage

VictorReinz.com

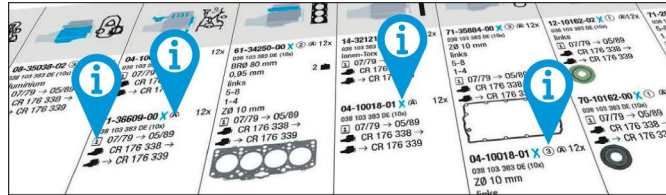

[VictorReinz.com/catalog-info](https://www.victorreinz.com/catalog-info)

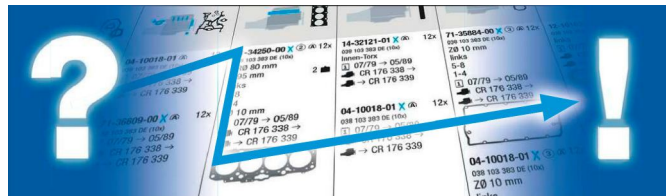

[VictorReinz.com/catalog-how-to-use](https://www.victorreinz.com/catalog-how-to-use)

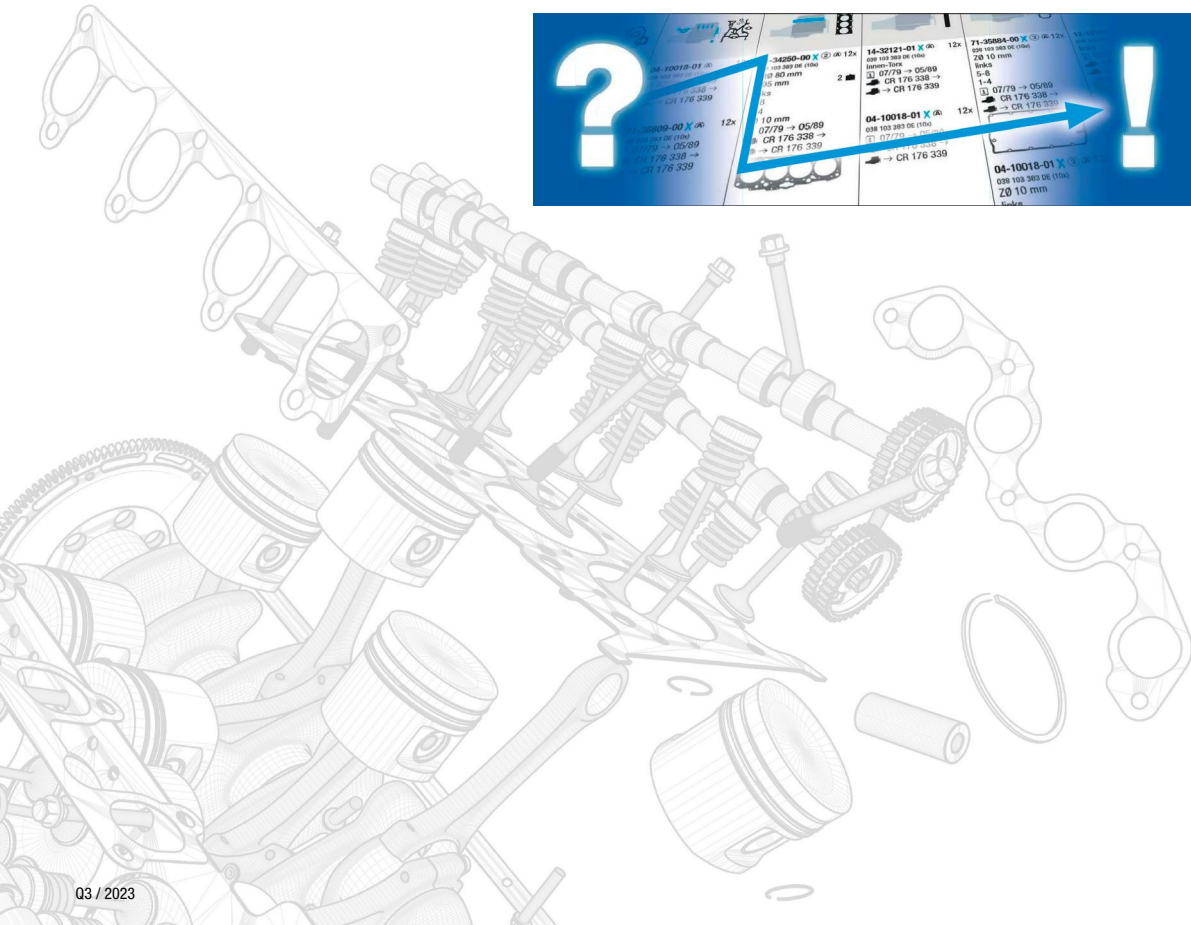

SAAB

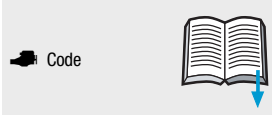

0-9

831 A1.000 5

831 A2.000 5

A

A 16 LET 6

A 19 DTR 8

A 20 DTH 9

A 20 DTR 10

A 20 NFT 10

A 20 NHT 10

A 28 NER 25

B

B 20 P 11

B20 12

B201 13

B201L 14

B201S 14

B201XC 13

B201XI 13

B201XL 14

B202 14

B202I 14

B202L 15

B202S 14

B202XI 14-15

B202XL 14-15

B204E 15

B204I 15

B204L 16

B204R 15

B204S 16

B205E 17

B205L 17-18

B205R 17

B206I 15

B207E 6, 18

B207G 19

B207H 19

B207L 19

B207M 19

B207R 18

B20C 12

B20I 12-13



B20T 13

B212I 20

B234E 21

B234I 21-22

B234L 21-23

B234R 21

B235E 23-24

B235L 23

B235R 23-24

B258I 24

B284L 25

B284R 25

B308E 25

B308I 26

BI 20 11

BSI 20 11

BT20 11

D

D223L 20-21

D308L 26

E

EJ205 19

EJ255 25

F

Ford V4 5

L

LAU 25

LF1 27

LP9 25

X

X 22 DTH 20

Y

Y 22 DTH 21

Z

Z 18 XE 7-8

Z 19 DT 9

















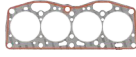
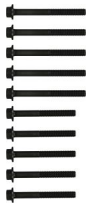







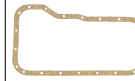



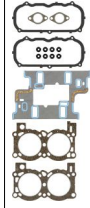
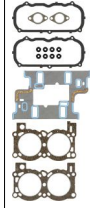





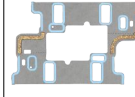

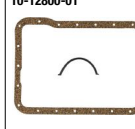





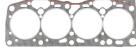

Z 19 DTH 9

Z 19 DTJ 9





Z 19 DTR 8

SAAB











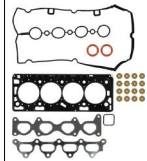



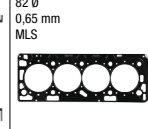
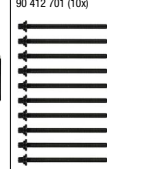
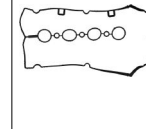
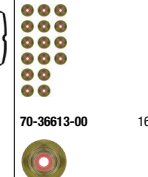
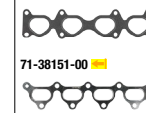



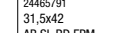



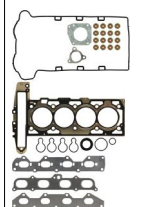
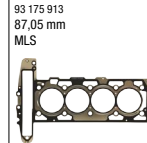
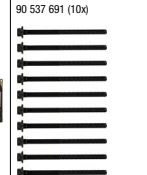
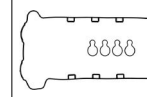
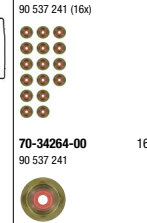

<p>Ltr.  1,3 831 A2.000 55 kW (75 PS) 600  1  01/80-12/86</p>					<p>61-31775-00 87,5 Ø</p> <p>61-31775-10 77,5 Ø 1,8 mm</p> 	<p>14-35733-01</p> 	<p>71-31731-00</p> 	<p>12-25837-01</p>  <p>70-25837-00 8x</p> 	<p>71-35716-00   </p> 	<p>71-12929-00</p> 	<p>81-35877-00 </p> <p>64x80 A SL LD MVQ</p>  <p>81-35883-00 N</p> <p>30x52 AB SL RD FPM</p> 
<p>1,5 Ford V4 46-50 kW (63-68 PS) 95 96 10/65-08/80</p>		<p>02-21255-02 88 14 287</p> 			<p>61-21255-30 L</p> <p>88 12 752 92,5 Ø 1,2 mm</p>  <p>61-21256-30 R</p> <p>88 12 760 92,5 Ø 1,2 mm</p> 		<p>71-12799-00 2x 88 11 077</p> 	<p>12-21569-01</p>  <p>70-21569-00 8x 88 12 067</p> 	<p>71-20421-40 </p> <p>88 31 034</p>  <p>50-92213-20  2x 88 01 466</p> 	<p>10-12800-01</p> 	<p>81-22700-10 </p> <p>34,94x49,96 A SL WD MVQ</p>  <p>81-20286-00 </p> <p>60,45x76,18 A SL LD FPM</p> 
<p>1,5 831 A1.000 63 kW (86 PS) 600 01/80-12/86</p>		<p>02-31825-02</p> 			<p>61-31825-10 87 Ø</p> 	<p>14-35733-01</p> 	<p>71-31731-00</p> 	<p>12-26058-02</p>  <p>70-26058-00 8x 75 00 713</p> 	<p>71-35716-00    2x</p> 	<p>71-12929-00</p> 	<p>81-35877-00 </p> <p>64x80 A SL LD MVQ</p>  <p>81-35883-00 N</p> <p>30x52 AB SL RD FPM</p>  <p>2x</p>

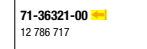
SAAB



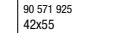







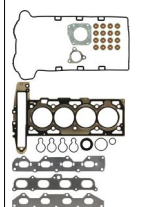
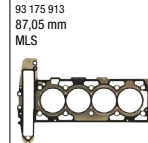
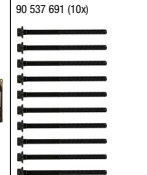
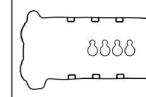
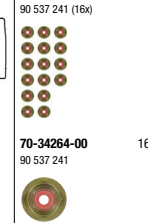

Ltr.  1.6 A 16 LET 132 kW (180 PS) 9-5 Turbo  05/10-01/12 

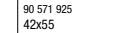

1,6 A 16 LET 132 kW (180 PS) 9-5 Turbo 05/10-01/12

 <p>02-37240-02</p>	 <p>08-38431-01</p>	 <p>71-36609-00 </p>	 <p>61-37240-00 82 Ø 0,65 mm MLS</p>	 <p>14-32103-01 90 412 701 (10x)</p>	 <p>71-38166-00</p>	 <p>12-36613-01 70-36613-00 16x</p>	 <p>71-38149-00 </p> <p>71-38151-00 </p>	 <p>70-31414-10</p>	 <p>81-35147-00 </p> <p>24465791 31,5x42 AB SL RD FPM</p>  <p>81-38236-00 </p> <p>80x98 A LD PTFE ACM</p>  <p>81-24909-10  2x</p> <p>45 03 983 35x48 A SL RD MVQ</p> 
 <p>02-36220-02</p>			 <p>61-36220-00 93 175 913 87,05 mm MLS</p>	 <p>14-32169-01 90 537 691 (10x)</p>	 <p>15-36236-01</p>	 <p>12-34264-01 90 537 241 (16x) 70-34264-00 16x</p>	 <p>71-36311-00 </p> <p>12 786 262</p>  <p>71-36321-00 </p> <p>12 786 717</p>  <p>71-37479-00 </p> <p>12 794 952</p>	 <p>70-31414-10</p>	 <p>81-33489-10 </p> <p>90 571 925 42x55 RD FPM</p>  <p>81-38229-00 </p> <p>45 01 201 90x104 A SL LD</p> 

1,8 B207E 110 kW (150 PS) 9-3 03/05-02/15

 <p>02-36220-02</p>			 <p>61-36220-00 93 175 913 87,05 mm MLS</p>	 <p>14-32169-01 90 537 691 (10x)</p>	 <p>15-36236-01</p>	 <p>12-34264-01 90 537 241 (16x) 70-34264-00 16x</p>	 <p>71-36311-00 </p> <p>12 786 262</p>  <p>71-36321-00 </p> <p>12 786 717</p>  <p>71-37479-00 </p> <p>12 794 952</p>	 <p>70-31414-10</p>	 <p>81-33489-10 </p> <p>90 571 925 42x55 RD FPM</p>  <p>81-38229-00 </p> <p>45 01 201 90x104 A SL LD</p> 
--	--	--	--	---	--	---	--	--	--

SAAB

Ltr. 1.8 Z18XE 90 kW (122 PS) 9-3 01/04-02/15

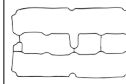
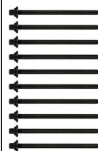
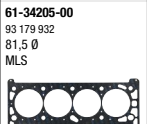
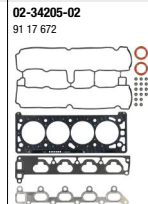























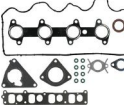









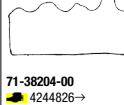



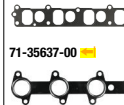







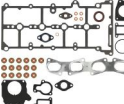
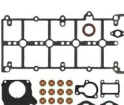





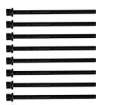
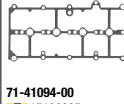
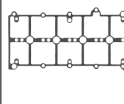

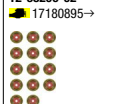











16x

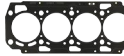
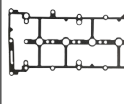
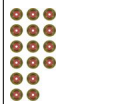

- 81-15512-50
 - 30x40
 - A SL RD FPM
- 81-24908-10
 - 55 355 235
 - 80x98
 - A SL LD FPM
 - 20DR5879
- 81-39433-00
 - 80x98,39
 - A LD PTFE
 - 20DR5880→
- 81-24909-10 **N** 2x
 - 45 03 983
 - 35x48
 - A SL RD MVQ

SAAB															
Ltr.															
1,8 Z18XE	90 kW (122 PS)	9-3	03/05-02/15												
					<p>02-34205-02 91 17 672</p>				<p>61-34205-00 93 179 932 81,5 Ø MLS</p>	<p>14-32103-01 90 412 701 (10x)</p>	<p>71-34304-00 90 536 414</p>	<p>12-34223-02 91 58 057 (16x)</p>	<p>71-31451-00 </p> <p>90 523 057</p> <p>71-34282-00 </p> <p>90 536 199</p>	<p>70-31414-10</p>	<p>81-15512-50 </p> <p>30x40 A SL RD FPM</p> <p>81-24908-10 </p> <p>55 355 235 80x98 A SL LD FPM 20DR5879</p> <p>81-39433-00 </p> <p>80x98,39 A LD PTFE 20DR5880→</p> <p>81-24909-10 N 2x</p> <p>45 03 983 35x48 A SL RD MVQ</p>
1,9 A19DTR Z19DTR	96-132 kW (130-180 PS)	9-3 TTiD 9-5 TiD	01/07-02/15						<p>61-38225-00 0,95 mm MLS</p> <p>61-38225-10 1,05 mm MLS</p> <p>61-38225-20 1,15 mm MLS</p>	<p>14-32321-01</p>	<p>71-42061-00</p>	<p>12-38209-02</p> <p>70-38209-00</p>	<p>71-39352-00 </p>	<p>70-31414-10</p>	<p>81-90027-00 </p> <p>93 178 503 93 Ø</p> <p>81-36229-00 N</p> <p>93 178 980 30x45 AB SL RD FPM</p>

SAAB

<p>Ltr. </p>											
<p>1,9 Z 19 DT 88 kW (120 PS) 9-3 TID 9-3 Turbo 09/04-02/15</p>	<p>02-35638-03 → 4244825</p>  <p>02-38204-02 → 4244826→</p> 	<p>08-36316-01 39 186+ 196 → 4244825</p>  <p>08-36278-01 → 4244826→</p> 	<p>04-10209-01 </p> 	<p>61-35580-00 83 Ø 0,82 mm</p> <p>61-35580-10 83 Ø 0,92 mm 1 </p> <p>61-35580-20 83 Ø 1,02 mm 2 </p> 	<p>14-35738-01 → 5685170</p>  <p>14-32321-01 → 5685171→</p> 	<p>71-35638-10 → 4244825</p>  <p>71-38204-00 → 4244826→</p> 	<p>12-25837-01</p>  <p>70-25837-00 8x</p> 	<p>71-36306-00 </p>  <p>71-35637-00 </p> 	<p>70-31414-10</p> 	<p>81-35882-00 </p> <p>93 180 737 31x41 AB SL RD FPM</p>  <p>81-90027-00 </p> <p>93 178 503 93 Ø</p>  <p>81-17539-50 N</p> <p>30x42 A SL RD FPM</p> 	
<p>1,9 Z 19 DTH 88-110 kW (120-150 PS) 9-3 TID 9-5 TID 09/04</p>	<p>02-36262-01 93 186 198 → 17180894</p>  <p>02-41094-01 → 17180895→</p> 	<p>08-36316-01 39 186+ 196</p> 	<p>04-10208-01 </p> 	<p>61-35855-00 93 138 224 83 Ø 0,82 mm MLS</p> <p>61-35855-10 93 138 226 83 Ø 0,92 mm MLS 1 </p> <p>61-35855-20 93 138 227 83 Ø 1,02 mm MLS 2 </p> 	<p>14-32332-01</p> 	<p>71-36262-00 93 178 481 → 17180894</p>  <p>71-41094-00 → 17180895→</p> 	<p>12-36208-01 93 178 590 (16x) → 17180894</p>  <p>12-38209-02 → 17180895→</p>  <p>70-36208-00 16x 93 178 590 → 17180894</p>  <p>70-38209-00 16x → 17180895→</p> 	<p>71-36307-00 </p> <p>93 178 058</p>  <p>71-35658-00 </p> <p>93 178 708</p> 	<p>70-31414-10</p> 	<p>81-35882-00 </p> <p>93 180 737 31x41 AB SL RD FPM</p>  <p>81-90027-00 </p> <p>93 178 503 93 Ø</p>  <p>81-36229-00 N</p> <p>93 178 980 30x45 AB SL RD FPM</p> 	
<p>2,0 A 20 DTH 118 kW (160 PS) 9-5 TID 05/10-01/12</p>				<p>61-37665-00 84 Ø 0,95 mm MLS</p> <p>61-37665-10 1,05 mm 1 </p> <p>61-37665-20 1,15 mm 2 </p> 		<p>71-42061-00</p> 	<p>12-38209-02</p>  <p>70-38209-00 16x</p> 	<p>11-40692-01 </p>  <p>71-39352-00 </p> 		<p>81-35882-00 </p> <p>93 180 737 31x41 AB SL RD FPM</p> 	

SAAB															
Ltr.															
2,0 A 20 DTR	140 kW (190 PS)	9-5 TTiD	05/10-01/12												
					02-39354-01 	08-39648-01 		61-37665-00 84 Ø 0,95 mm MLS 61-37665-10 1,05 mm MLS 61-37665-20 1,15 mm MLS 	14-32332-01 	71-42061-00 	12-38209-02 16x 70-38209-00 	11-40692-01 71-39352-00 	70-31414-10 	81-35882-00 93 180 737 31x41 AB SL RD FPM 81-90027-00 93 178 503 93 Ø 81-36229-00 93 178 980 30x45 AB SL RD FPM 81-40269-00 30x50 AW SL RD FPM	
2,0 A 20 NFT	162 kW (220 PS)	9-3 9-3 Turbo 9-5 Turbo	01/08-02/15		02-37265-01 	08-39572-01 		61-37265-00 87 Ø 0,64 mm MLS 	14-32169-01 90 537 691 (10x) 	15-11037-01 	12-34264-01 90 537 241 (16x) 16x 70-34264-00 90 537 241 	71-38154-00 71-39351-00 	70-31414-10 	81-33489-10 90 571 925 42x55 RD FPM 81-38229-00 45 01 201 90x104 A SL LD 	
2,0 A 20 NHT	162 kW (220 PS)	9-5 Turbo	05/10-01/12		02-37265-01 	08-39572-01 	04-10378-01 	61-37265-00 87 Ø 0,64 mm MLS 	14-32169-01 90 537 691 (10x) 	15-11037-01 	12-34264-01 90 537 241 (16x) 16x 70-34264-00 90 537 241 	71-38154-00 71-39351-00 	70-31414-10 	81-33489-10 90 571 925 42x55 RD FPM 81-38229-00 45 01 201 90x104 A SL LD 	

SAAB

Ltr.	Motor	Power (kW/PS)	Model	Year	Part 1	Part 2	Part 3	Part 4	Part 5	Part 6	Part 7	Part 8	Part 9	Part 10	Part 11
2,0	B 20 P	70 kW (95 PS)	99	10/72-08/74											
2,0	BI 20	85-87 kW (115-118 PS)	900 900 i 99	09/78-08/90											
2,0	BSI 20	107 kW (146 PS)	900 Turbo 99 Turbo	10/77-07/85											
2,0	BT20	79 kW (107 PS)	900	09/78-08/84											

61-23325-10
83 58 780
91 Ø
1,2 mm

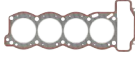

61-23325-10
83 58 780
91 Ø
1,2 mm

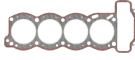

71-13015-00
93 05 970



71-25787-10
83 48 518



71-25181-10
83 61 842



71-27818-00
75 14 946



71-27818-00
75 14 946



81-25789-00
93 09 204
48x66,65
A SL RD MVQ



81-24378-10
91 75 902
88x108
A SL LD FPM



61-23325-10
83 58 780
91 Ø
1,2 mm

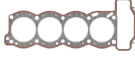

71-13008-00
83 59 226
BSI20P02000265



71-13015-00
93 05 970
BSI20P02000266



71-25787-10
83 48 518



71-25181-10
83 61 842



71-27818-00
75 14 946



81-25789-00
93 09 204
48x66,65
A SL RD MVQ



81-24378-10
91 75 902
88x108
A SL LD FPM



61-23325-10
83 58 780
91 Ø
1,2 mm

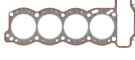

71-13015-00
93 05 970



71-25181-10
83 61 842



71-27818-00
75 14 946



81-25789-00
93 09 204
48x66,65
A SL RD MVQ



81-24378-10
91 75 902
88x108
A SL LD FPM

























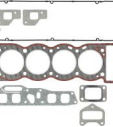
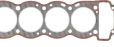













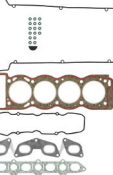



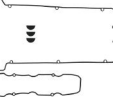









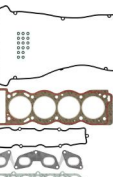

SAAB

Ltr.	Engine	Power	Year	Part 1	Part 2	Part 3	Part 4	Part 5	Part 6	Part 7	Part 8	Part 9	Part 10	Part 11	Part 12
2,0	B20	74-81 kW (101-110 PS)	900 99	02/79-12/88											
									61-23325-10 83 58 780 91 Ø 1,2 mm 		71-13015-00 83 05 970 		71-25181-10 2x 83 61 842 71-25788-10 83 61 859 	71-27818-00 75 14 946 	81-25789-00 K 93 09 204 48x66,65 A SL RD MVQ 81-24378-10 K 91 75 902 88x108 A SL LD FPM
2,0	B20C	74 kW (100 PS)	99	09/74-12/79					61-23325-10 83 58 780 91 Ø 1,2 mm 		71-13008-00 83 59 226 12/78 71-13015-00 83 05 970 01/79→ 		71-25181-10 2x 83 61 842 71-27818-00 75 14 946 	81-25789-00 K 93 09 204 48x66,65 A SL RD MVQ 81-24378-10 K 91 75 902 88x108 A SL LD FPM 	
2,0	B20C	74 kW (100 PS)	99	09/74-12/84	02-25835-04 93 37 239 				61-23325-10 83 58 780 91 Ø 1,2 mm 12/80 61-25835-10 75 05 217 91 Ø 1,3 mm 01/81→ 		71-13008-00 83 59 226 12/78 71-13015-00 83 05 970 01/79→ 71-25846-00 83 55 991 01/81→ 	71-25859-10 83 07 257 71-25788-10 83 61 859 01/81→ 71-25181-10 2x 83 61 842 	71-27818-00 75 14 946 	81-25789-00 K 93 09 204 48x66,65 A SL RD MVQ 81-24378-10 K 91 75 902 88x108 A SL LD FPM 	
2,0	B20I	74 kW (100 PS)	99	09/74-12/84	02-25835-04 93 37 239 				61-23325-10 83 58 780 91 Ø 1,2 mm 12/80 61-25835-10 75 05 217 91 Ø 1,3 mm 01/81→ 		71-13008-00 83 59 226 71-13015-00 83 05 970 71-25846-00 83 55 991 	71-25859-10 83 07 257 71-25788-10 83 61 859 01/81→ 71-25181-10 2x 83 61 842 	71-27818-00 75 14 946 	81-25789-00 K 93 09 204 48x66,65 A SL RD MVQ 81-24378-10 K 91 75 902 88x108 A SL LD FPM 	

SAAB

Ltr.	Icon	Power	Year	Icon	Part No.	Part No.	Part No.	Part No.	Part No.	Part No.	Part No.	Part No.	Part No.	Part No.	Part No.	Part No.	Part No.	Part No.	
2,0	B20i B20T B201XC	74-79 kW (100-107 PS)	90 900 99	1	03/76-12/88	02-25835-04 93 37 239			61-25835-10 75 05 217 91 Ø 1,3 mm		71-25846-00 93 55 991		71-25859-10 93 07 257	71-27818-00 75 14 946	81-25789-00 93 09 204 48x66,65 A SL RD MVQ	81-24378-10 91 75 902 88x108 A SL LD FPM			
2,0	B20i	85 kW (116 PS)	99		07/76-07/81	02-25835-04 93 37 239 01/81→			61-23325-10 83 58 780 91 Ø 1,2 mm 01/81→ 12/80		71-13008-00 83 59 226 01/79→ 12/78		71-25859-10 93 07 257 01/81→	71-27818-00 75 14 946	81-25789-00 93 09 204 48x66,65 A SL RD MVQ	81-24378-10 91 75 902 88x108 A SL LD FPM			
2,0	B20i	87 kW (118 PS)	99		09/74-12/78				61-25835-10 75 05 217 91 Ø 1,3 mm 01/81→		71-13015-00 93 05 970 01/79→ 12/80		71-25846-00 93 55 991 01/81→	71-25859-10 93 07 257 01/81→	71-27818-00 75 14 946	81-25789-00 93 09 204 48x66,65 A SL RD MVQ	81-24378-10 91 75 902 88x108 A SL LD FPM		
2,0	B20i	87 kW (118 PS)	99		09/74-12/78				61-23325-10 83 58 780 91 Ø 1,2 mm		71-13008-00 83 59 226		71-25859-10 93 07 257 83 61 842	71-27818-00 75 14 946	81-25789-00 93 09 204 48x66,65 A SL RD MVQ	81-24378-10 91 75 902 88x108 A SL LD FPM			
2,0	B20i B201XI	74-85 kW (100-115 PS)	900 900 i 99		04/72-10/91	01-25835-05 93 37 221	02-25835-05 93 37 247		61-25835-10 75 05 217 91 Ø 1,3 mm		71-25846-00 93 55 991		71-25860-10 75 82 315	71-27818-00 75 14 946	81-25789-00 93 09 204 48x66,65 A SL RD MVQ	81-24378-10 91 75 902 88x108 A SL LD FPM			

SAAB

<p>Ltr. </p>	<p>2,0 B201L 114 kW (155 PS) 900 900 I 10/86-12/90</p>												
<p>2,0 B201S B201XL</p>	<p>103-110 kW (140-150 PS) 900 Turbo 09/78-12/91</p>	<p>01-25835-06</p>	<p>02-25835-06 93 37 254</p> 			<p>61-25835-10 75 05 217 91 Ø 1,3 mm</p> 	<p>14-32227-01 59 55 794 (10x)</p> 	<p>71-25846-00 93 55 991</p> 	<p>71-25860-10 </p> <p>75 82 315</p> 	<p>71-25181-10 </p> <p>83 61 842</p> 	<p>71-25788-10 </p> <p>83 61 859</p> 	<p>71-27818-00 75 14 946</p> 	<p>81-25789-00 </p> <p>93 09 204 48x66.65 A SL RD MVQ</p>  <p>81-24378-10 </p> <p>91 75 902 88x108 A SL LD FPM</p> 
<p>2,0 B202 B202XI B202XL</p>	<p>92-129 kW (125-175 PS) 9000 9000 Turbo 09/84-09/93</p>		<p>02-35235-02 88 18 007 +75 00 713 (16x)  G 52494</p> 			<p>61-35235-00 91 69 079 91 Ø</p> 	<p>14-32227-01 59 55 794 (10x)</p> 	<p>15-35316-01 88 17 512  G 52494</p> 	<p>12-26058-03 75 00 713 (16x)</p> 	<p>71-35199-00 </p> <p>75 84 436</p> 	<p>71-35198-00 </p> <p>75 18 996</p> 	<p>81-25789-00 </p> <p>93 09 204 48x66.65 A SL RD MVQ</p>  <p>81-24378-10 </p> <p>91 75 902 88x108 A SL LD FPM</p> 	
<p>2,0 B202I B202S</p>	<p>93-110 kW (126-150 PS) 900 900 Turbo 9000 9000 CD 9000 Turbo 10/87-12/98</p>		<p>02-35235-03 88 19 831 +75 00 713 (16x)</p> 			<p>61-35235-00 91 69 079 91 Ø</p> 	<p>14-32227-01 59 55 794 (10x)</p> 	<p>15-35281-02 93 21 464  G 52495→</p>	<p>12-26058-03 75 00 713 (16x)</p> 	<p>71-35199-00 </p> <p>75 84 436</p> 	<p>71-35198-00 </p> <p>75 18 996</p> 	<p>81-25789-00 </p> <p>93 09 204 48x66.65 A SL RD MVQ</p>  <p>81-24378-10 </p> <p>91 75 902 88x108 A SL LD FPM</p> 	

SAAB

Ltr.	Engine	Power	Model	Year	Image 1	Image 2	Image 3	Image 4	Image 5	Image 6	Image 7	Image 8	Image 9	Image 10	
2,0	B202L	118-150 kW (160-204 PS)	900 Turbo 9000 9000 Turbo	09/84-12/98											
						<p>02-35235-02 88 18 007 +75 00 713 (16x)</p>				<p>61-35235-00 91 69 079 91 0</p>	<p>14-32227-01 59 55 794 (10x)</p>	<p>15-35316-01 88 17 512</p>	<p>12-26058-03 75 00 713 (16x)</p> <p>70-26058-00 75 00 713</p> <p>16x</p>	<p>71-35199-00 </p> <p>75 84 436</p> <p>71-35198-00 </p> <p>75 18 996</p>	<p>81-25789-00 </p> <p>93 09 204 48x66,65 A SL RD MVQ</p> <p>81-24378-10 </p> <p>91 75 902 88x108 A SL LD FPM</p>
2,0	B202XI B202XL	92-129 kW (125-175 PS)	900 900 Turbo	01/84-06/94		<p>02-35235-02 88 18 007 +75 00 713 (16x) G 110406</p> <p>02-35235-03 88 19 831 +75 00 713 (16x) G 110407→</p>				<p>61-35235-00 91 69 079 91 0</p>	<p>14-32227-01 59 55 794 (10x)</p>	<p>15-35316-01 88 17 512 G 110406</p> <p>15-35281-02 93 21 464 G 110407→</p>	<p>12-26058-03 75 00 713 (16x)</p> <p>70-26058-00 75 00 713</p> <p>16x</p>	<p>71-35199-00 </p> <p>75 84 436</p> <p>71-35198-00 </p> <p>75 18 996</p>	<p>81-25789-00 </p> <p>93 09 204 48x66,65 A SL RD MVQ</p> <p>81-24378-10 </p> <p>91 75 902 88x108 A SL LD FPM</p>
2,0	B204E B204I B204R B206I	96-147 kW (131-200 PS)	900 9000 9000 CD 9000 Turbo 9-3 9-3 Turbo	09/92-08/03		<p>02-35290-01 88 22 033 +75 00 713 (16x) +88 22 041</p>				<p>61-35290-00 91 85 695 91 0</p>	<p>14-32227-01 59 55 794 (10x)</p>	<p>15-35281-02 93 21 464</p>	<p>12-26058-03 75 00 713 (16x)</p> <p>70-26058-00 75 00 713</p> <p>16x</p>	<p>71-35201-00 </p> <p>91 38 884</p> <p>71-35269-00 </p> <p>91 66 497</p>	<p>81-25789-00 </p> <p>93 09 204 48x66,65 A SL RD MVQ</p> <p>81-24378-10 </p> <p>91 75 902 88x108 A SL LD FPM</p>

SAAB

Ltr.	Engine	Power	Model	Year	Image 1	Image 2	Image 3	Image 4	Image 5	Image 6	Image 7	Image 8	Image 9	Image 10	Image 11	
2,0	B204L	136 kW (185 PS)	9-3 Turbo	02/98-08/03												
						<p>02-35290-01 88 22 033 +75 00 713 (16x) +88 22 041</p>				<p>61-35290-00 91 85 695 91 Ø</p>	<p>14-32227-01 59 55 794 (10x)</p>	<p>15-35281-02 93 21 464</p>	<p>12-26058-03 75 00 713 (16x)</p>	<p>71-35201-00 </p> <p>91 38 884</p> <p>71-35269-00 </p> <p>91 66 497</p>	<p>71-27818-00 75 14 946</p>	<p>81-25789-00 </p> <p>93 09 204 48x66,65 A SL RD MVQ</p> <p>81-24378-10 </p> <p>91 75 902 88x108 A SL LD FPM</p>
2,0	B204L	136-143 kW (185-195 PS)	900 Turbo 9000	09/89-02/98												
						<p>02-35290-01 88 22 033 +75 00 713 (16x) +88 22 041</p>				<p>61-35290-00 91 85 695 91 Ø</p>	<p>14-32227-01 59 55 794 (10x)</p>	<p>15-35281-02 93 21 464</p>	<p>12-26058-03 75 00 713 (16x)</p>	<p>71-35201-00 </p> <p>91 38 884</p> <p>71-35269-00 </p> <p>91 66 497</p>	<p>71-27818-00 75 14 946</p>	<p>81-25789-00 </p> <p>93 09 204 48x66,65 A SL RD MVQ</p> <p>81-24378-10 </p> <p>91 75 902 88x108 A SL LD FPM</p> <p>81-25452-10 </p> <p>87 87 764 88x108 AB SL LD FPM</p>
2,0	B204S	110 kW (150 PS)	9000 CD 9000 Turbo	09/93-12/98												
						<p>02-35290-01 88 22 033 +75 00 713 (16x) +88 22 041</p>				<p>61-35290-00 91 85 695 91 Ø</p>	<p>14-32227-01 59 55 794 (10x)</p>	<p>15-35281-02 93 21 464</p>	<p>12-26058-03 75 00 713 (16x)</p>	<p>71-35201-00 </p> <p>91 38 884</p> <p>71-35269-00 </p> <p>91 66 497</p>	<p>81-25789-00 </p> <p>93 09 204 48x66,65 A SL RD MVQ</p> <p>81-24378-10 </p> <p>91 75 902 88x108 A SL LD FPM</p>	

SAAB

Ltr.	Engine	Power	Configuration	Year	Image 1	Image 2	Image 3	Image 4	Image 5	Image 6	Image 7	Image 8	Image 9	Image 10	Image 11
2,0	B205E	110 kW (150 PS)	9-3 Turbo	01/06-12/09											
					02-35295-01 		04-10218-01 	61-35295-00 59 55 174 91 0 0,4 mm MLS 	14-32227-01 59 55 794 (10x) 	15-35281-02 93 21 464 	12-36497-01 59 55 570 (16x) 	71-13254-00 93 09 204 71-35273-00 91 86 404 	71-35269-00 91 66 497 	81-25789-00 93 09 204 48x66,65 A SL RD MVQ 	81-24378-10 91 75 902 88x108 A SL LD FPM
2,0	B205E	110-132 kW (150-179 PS)	9-3 Turbo 9-5 Turbo	09/97-12/09											
					02-35295-01 		04-10218-01 	61-35295-00 59 55 174 91 0 0,4 mm MLS 	14-32227-01 59 55 794 (10x) 	15-35281-02 93 21 464 	12-36497-01 59 55 570 (16x) 	71-13254-00 91 86 412 12/05 55 355 267 01/06- 71-35273-00 91 86 404 	71-35269-00 91 66 497 	81-25789-00 93 09 204 48x66,65 A SL RD MVQ 	81-24378-10 91 75 902 88x108 A SL LD FPM
2,0	B205E B205L B205R	110-151 kW (150-205 PS)	9-3 Turbo 9-5 Turbo	02/98-08/03											
					02-35295-01 		04-10218-01 	61-35295-00 59 55 174 91 0 0,4 mm MLS 	14-32227-01 59 55 794 (10x) 	15-35281-02 93 21 464 	12-36497-01 59 55 570 (16x) 	71-13254-00 91 86 412 12/05 55 355 267 01/06- 71-35273-00 91 86 404 	71-35269-00 91 66 497 	81-25789-00 93 09 204 48x66,65 A SL RD MVQ 	81-24378-10 91 75 902 88x108 A SL LD FPM

SAAB

Ltr.	Engine	Power	Model	Year	Image 1	Image 2	Image 3	Image 4	Image 5	Image 6	Image 7	Image 8	Image 9	Image 10	Image 11	Image 12
2,0	B205L	136 kW (185 PS)	9-5 Turbo	07/00-07/01												
						02-35295-01		04-10218-01	61-35295-00 59 55 174 91 0 0,4 mm MLS	14-32227-01 59 55 794 (10x)	15-35281-02 93 21 464	12-36497-01 59 55 570 (16x)	71-35272-00 91 86 412	71-27818-00 75 14 946	81-25789-00 93 09 204 48x66,65 A SL RD MVQ	81-24378-10 91 75 902 88x108 A SL LD FPM
2,0	B205L	136 kW (185 PS)	9-5 Turbo	07/00-12/09		02-35295-01		04-10218-01	61-35295-00 59 55 174 91 0 0,4 mm MLS	14-32227-01 59 55 794 (10x)	15-35281-02 93 21 464	12-36497-01 59 55 570 (16x)	71-35272-00 91 86 412 12/05	71-27818-00 75 14 946	81-25789-00 93 09 204 48x66,65 A SL RD MVQ	81-24378-10 91 75 902 88x108 A SL LD FPM
2,0	B207E B207R	110-185 kW (150-252 PS)	9-3 9-3 Turbo	09/02-02/15		02-36220-02			61-36220-00 93 175 913 87,05 mm MLS	14-32169-01 90 537 691 (10x)	15-36236-01	12-34264-01 90 537 241 (16x)	71-36311-00 12 786 262	70-31414-10	81-33489-10 90 571 925 42x55 RD FPM	81-38229-00 45 01 201 90x104 A SL LD
												71-36321-00 12 786 717				
												71-37479-00 12 794 952				























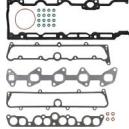



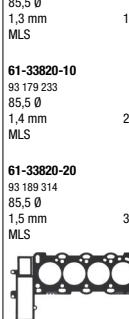

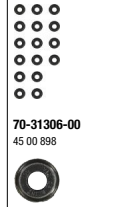



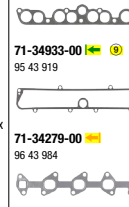



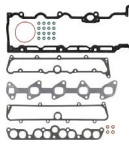
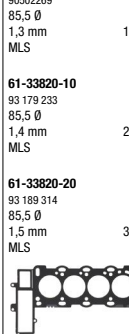
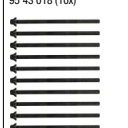
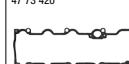
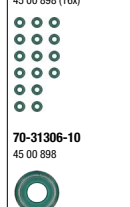



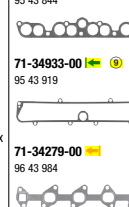

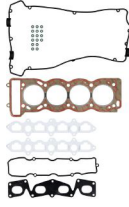

SAAB

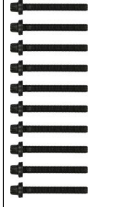
Ltr.	Engine	Power	Configuration	Year	Image 1	Image 2	Image 3	Image 4	Image 5	Image 6	Image 7	Image 8	Image 9	Image 10	Image 11	Image 12
2,0	B207G B207H B207M	120-147 kW (163-200 PS)	9-3 9-3 Turbo	01/07-02/15												
						02-36220-01	08-38272-01	04-10166-01	61-36220-00 93 175 913 87,05 mm MLS	14-32169-01 90 537 691 (10x)	15-36236-01	12-34264-01 90 537 241 (16x)	71-36311-00 12 786 262	70-31414-10	81-33489-10 90 571 925 42x55 RD FPM	
												70-34264-00 90 537 241	71-36321-00 12 786 717		81-38229-00 45 01 201 90x104 A SL LD	
2,0	B207L	129-143 kW (175-194 PS)	9-3 9-3 Turbo	09/02-02/15		02-36220-02		04-10166-01	61-36220-00 93 175 913 87,05 mm MLS	14-32169-01 90 537 691 (10x)	15-36236-01	12-34264-01 90 537 241 (16x)	71-36311-00 12 786 262	70-31414-10	81-33489-10 90 571 925 42x55 RD FPM	
												70-34264-00 90 537 241	71-36321-00 12 786 717		81-38229-00 45 01 201 90x104 A SL LD	
2,0	EJ205	169 kW (230 PS)	9-3	09/04-12/05	01-53940-01	02-53940-01			61-53940-00 2x 93,7 Ø MLS		15-53947-01	12-53919-01	71-53941-00 2x	70-31414-10	81-53918-00 33x49 A SL RD FPM	
											15-53948-01	71-52938-10 2x			81-53333-00 86x103 A SL LD MVQ	
												71-53942-00 		81-53944-00 32x55 A SL RD FPM	4x	
												71-53943-00 				

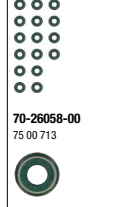
SAAB

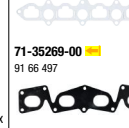
SAAB														
Ltr.														
2,1	B212l	100 kW (136 PS)	900	08/90-06/94		<p>02-35240-01 93 21 597</p>			<p>61-35240-00 87 87 111 94 Ø 1,3 mm</p>	<p>14-32227-01 59 55 794 (10x)</p>	<p>15-35281-02 93 21 464</p>	<p>12-26058-03 75 00 713 (16x)</p>	<p>71-35197-00 </p> <p>91 26 277</p> <p>71-35198-00 </p> <p>75 18 996</p> <p>70-26058-00 </p> <p>75 00 713</p> <p>16x</p>	<p>81-25789-00 </p> <p>93 09 204 48x66,65 A SL RD MVQ</p> <p>81-24378-10 </p> <p>91 75 902 88x108 A SL LD FPM</p>
2,1	B212l	107 kW (145 PS)	900	10/89-07/92		<p>02-35240-01 93 21 597</p>		<p>61-34330-00 93 170 143 87 Ø 0,5 mm MLS</p>	<p>14-32227-01 59 55 794 (10x)</p>	<p>15-35281-02 93 21 464</p>	<p>12-26058-03 75 00 713 (16x)</p>	<p>71-35197-00 </p> <p>91 26 277</p>	<p>81-25789-00 </p> <p>93 09 204 48x66,65 A SL RD MVQ</p> <p>81-24378-10 </p> <p>91 75 902 88x108 A SL LD FPM</p>	
2,2	D223L X 22 DTH	85-92 kW (115-125 PS)	9-3 TID 9-5 TID	02/98-12/09		<p>02-34277-01 93 21 597</p>	<p>08-34164-01</p>	<p>61-33820-00 90502269 85,5 Ø 1,3 mm MLS</p> <p>61-33820-10 93 179 233 85,5 Ø 1,4 mm MLS</p> <p>61-33820-20 93 189 314 85,5 Ø 1,5 mm MLS</p>	<p>14-32105-01 95 43 018 (10x)</p>	<p>71-34277-00 47 73 420</p>	<p>12-31306-12 45 00 898 (16x)</p>	<p>71-34286-00 </p> <p>95 43 844</p> <p>71-34933-00 </p> <p>95 43 919</p> <p>71-34279-00 </p> <p>96 43 984</p> <p>16x</p>	<p>71-34164-00 47 72 026</p> <p>81-35723-00 </p> <p>95 43 455 55x68 AB SL RD FPM</p> <p>81-34301-00 </p> <p>95 43 083 99x114 A LD FPM/ACM</p>	

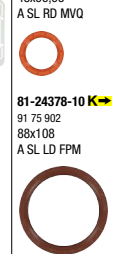

SAAB

<p>Ltr. </p>											
<p>2,2 D223L 92 kW (125 PS) 9-3 TID 09/02-02/15</p>	<p>02-34277-01 90502269 85,5 Ø 1,3 mm MLS</p> 	<p>08-34164-01</p> 	<p>04-10191-01 </p> 	<p>61-33820-00 90502269 85,5 Ø 1,3 mm MLS</p> <p>61-33820-10 93 179 233 85,5 Ø 1,4 mm MLS</p> <p>61-33820-20 93 189 314 85,5 Ø 1,5 mm MLS</p> 	<p>14-32105-01 95 43 018 (10x)</p> 	<p>71-34277-00 47 73 420</p> 	<p>12-31306-12 45 00 898 (16x)</p> 	<p>71-34286-00 </p> <p>95 43 844</p> <p>71-34933-00 </p> <p>95 43 919</p> <p>71-34279-00 </p> <p>96 43 984</p> 	<p>71-34164-00 47 72 026</p> 	<p>81-35723-00 </p> <p>95 43 455 55x68 AB SL RD FPM</p> <p>81-34301-00 </p> <p>95 43 083 99x114 A LD FPM/ACM</p> 	
<p>2,2 Y 22 DTH 85-88 kW (116-120 PS)</p>	<p>02-34277-01</p> 			<p>61-33820-00 90502269 85,5 Ø 1,3 mm MLS</p> <p>61-33820-10 93 179 233 85,5 Ø 1,4 mm MLS</p> <p>61-33820-20 93 189 314 85,5 Ø 1,5 mm MLS</p> 	<p>14-32105-01 95 43 018 (10x)</p> 	<p>71-34277-00 47 73 420</p> 	<p>12-31306-01 45 00 898 (16x)</p> 	<p>71-34286-00 </p> <p>95 43 844</p> <p>71-34933-00 </p> <p>95 43 919</p> <p>71-34279-00 </p> <p>96 43 984</p> 		<p>81-35723-00 </p> <p>95 43 455 55x68 AB SL RD FPM</p> <p>81-34301-00 </p> <p>95 43 083 99x114 A LD FPM/ACM</p> 	
<p>2,3 B234E B234I B234L B234R</p> <p>108-165 kW (147-224 PS)</p> <p>900 9000 9000 AERO CS 9000 CDE 9000 CDE Eco-Power 9000 Turbo 9-3</p> <p>09/90-08/03</p>	<p>02-35290-01 88 22 033 +75 00 713 (16x) +88 22 041</p> 			<p>61-35290-00 91 85 695 91 Ø</p> 	<p>14-32227-01 59 55 794 (10x)</p> 	<p>15-35281-02 93 21 464</p> 	<p>12-26058-03 75 00 713 (16x)</p> 	<p>71-35201-00 </p> <p>91 38 884</p> <p>71-35269-00 </p> <p>91 66 497</p> 	<p>71-27818-00 75 14 946</p> 	<p>81-25789-00 </p> <p>93 09 204 48x66,65 A SL RD MVQ</p> <p>81-24378-10 </p> <p>91 75 902 88x108 A SL LD FPM</p> 	

SAAB

SAAB													
2.3	B234I B234L	107-147 kW (146-200 PS)	900 9000 9000 CD 9000 CD Turbo	08/89-12/98	02-35235-01 93 21 605 +75 00 713 (16x) 1 → 09/93	02-35290-01 88 22 033 +75 00 713 (16x) +88 22 041 1 → 09/93→	61-35235-00 91 69 079 91 0 1 → 09/93	14-32227-01 59 55 794 (10x)	15-35281-02 93 21 464	12-26058-03 75 00 713 (16x)	71-35197-00 91 26 277 1 → 09/93	71-27818-00 75 14 946	81-25789-00 93 09 204 48x66,65 A SL RD MVQ
2.3	B234I	110 kW (150 PS)	9000	10/89-01/92	02-35235-01 93 21 605 +75 00 713 (16x)		61-35235-00 91 69 079 91 0	14-32227-01 59 55 794 (10x)	15-35281-02 93 21 464	12-26058-03 75 00 713 (16x)	71-35197-00 91 26 277	71-27818-00 75 14 946	81-25789-00 93 09 204 48x66,65 A SL RD MVQ

SAAB

Ltr.  2,3 B234L 143 kW (195 PS)  9000 Turbo  1 09/90-12/98

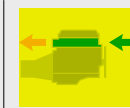

2,3 B234L 143 kW (195 PS) 9000 Turbo 09/90-12/98

02-35235-01
93 21 605
+75 00 713 (16x)
1 → 09/93

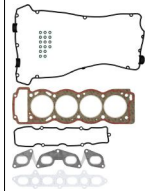

02-35290-01
88 22 033
+75 00 713 (16x)
+88 22 041
1 → 09/93→

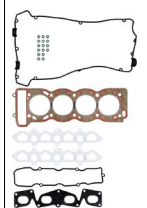

02-35290-01
88 22 033
+75 00 713 (16x)
+88 22 041

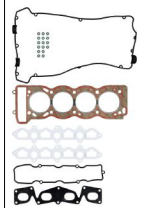

61-35235-00
91 69 079
91 0
1 → 09/93



61-35290-00
91 85 695
91 0
1 → 09/93→

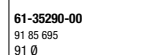

61-35290-00
91 85 695
91 0



14-32227-01
59 55 794 (10x)

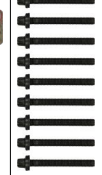

15-35281-02
93 21 464



12-26058-03
75 00 713 (16x)



70-26058-00
75 00 713



71-35197-00 
91 26 277
1 → 09/93



71-35201-00 
91 38 884
1 → 09/93→



71-35201-00 
91 38 884



71-35198-00 
75 18 996
1 → 09/93



71-35269-00 
91 66 497
1 → 09/93→



71-35269-00 
91 66 497



71-27818-00
75 14 946



81-25789-00 
93 09 204
48x66,65
A SL RD MVQ





81-24378-10 
91 75 902
88x108
A SL LD FPM

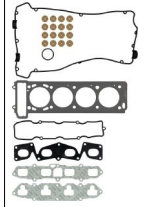

2,3 B235E 125-191 kW (170-260 PS) 9-3 Turbo 10/98-12/09
B235L 9-5 Turbo
B235R

02-35295-01



04-10218-01 

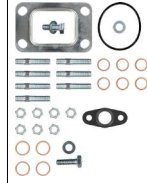

61-35295-00
59 55 174
91 0
0,4 mm
MLS



14-32227-01
59 55 794 (10x)

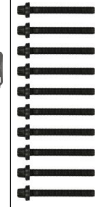

15-35281-02
93 21 464



12-36497-01
59 55 570 (16x)

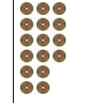

70-36497-00
59 55 570



71-35272-00 
91 86 412
1 → 12/05



71-13254-00 
55 355 267
1 → 01/06→



71-35273-00 
91 86 404



71-35269-00 
91 66 497

























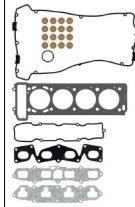
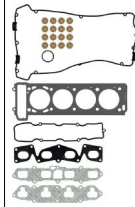

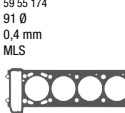

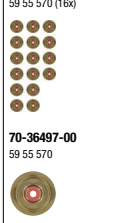
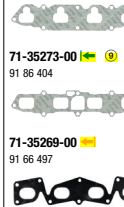

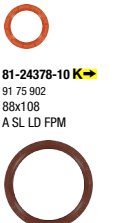
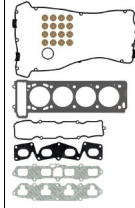
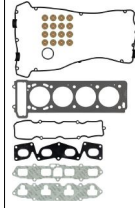

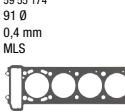
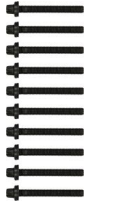

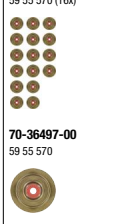
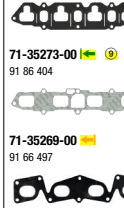
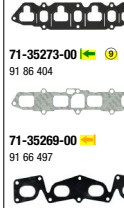
81-25789-00 
93 09 204
48x66,65
A SL RD MVQ

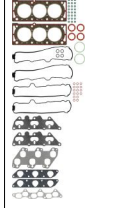



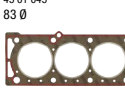

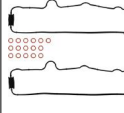
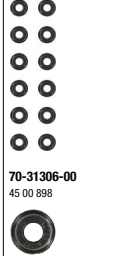
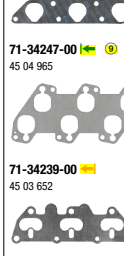
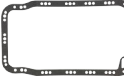





















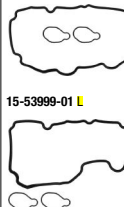
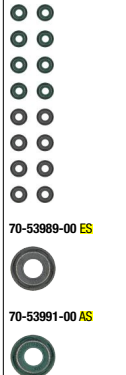
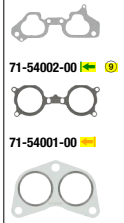

81-24378-10 
91 75 902
88x108
A SL LD FPM

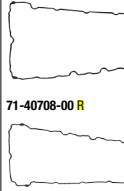
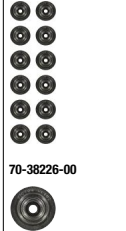



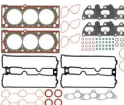
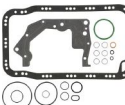
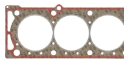

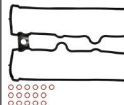
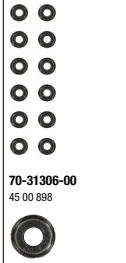
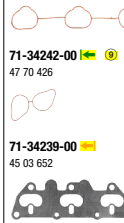
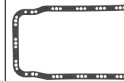

















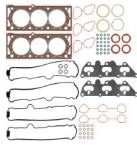

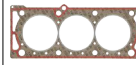
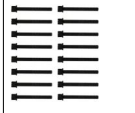
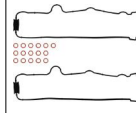
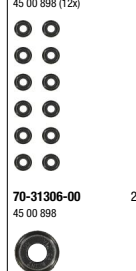













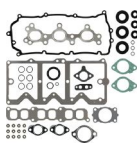







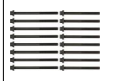

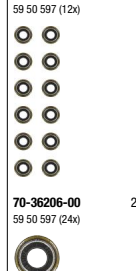

SAAB

Ltr. 											
2,3 B235E B235R 125-224 kW (170-305 PS) 9-3 9-3 Turbo 9-5 Turbo 09/97-08/05  1											
2,3 B235E B235R 134-191 kW (182-260 PS) 9-3 Turbo 9-5 Turbo 01/06-12/09											
2,5 B258I 125 kW (170 PS) 900 V6 07/93-02/98											



SAAB















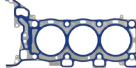

<p>Ltr. </p>											
<p>2,5 EJ255 172 kW (233 PS) 9-3 09/05-12/06</p>	<p>01-53910-01</p> 	<p>02-53910-01</p> 			<p>61-53910-00 2x 101.3 Ø MLS</p> 	<p>14-11012-01 2x</p> 	<p>15-53998-01 R 15-53999-01 L</p> 	<p>12-53989-01 70-53989-00 ES 8x 70-53991-00 AS 8x</p> 	<p>71-53941-00 L 2x 71-54002-00 L 2x 71-54001-00 2x</p> 	<p>70-31414-10</p> 	<p>81-53918-00 K 33x49 A SL RD FPM 81-53333-00 K 86x103 A SL LD MVQ 81-53944-00 N 32x55 A SL RD FPM 81-54006-00 N 42x55 A SL RD FPM</p> 
<p>2,8 A 28 NER B284L B284R LAU LP9 169-224 kW (230-305 PS) Tractor 9-3 9-3 Turbo 9-3 Turbo V6 9-5 Turbo 03/05-02/15</p>					<p>61-37220-00 R 61-37225-00 L MLS</p> 	<p>14-32293-01 2x</p> 	<p>71-40707-00 L 71-40708-00 R</p> 	<p>12-38226-01 24x</p> 	<p>71-38239-00 2x</p> 	<p>70-31414-10</p> 	<p>81-38237-00 K 50x70 AB SL RD PTFE 81-90046-00 K 173x228 A SL LD LD PTFE</p> 
<p>3,0 B308E 147 kW (200 PS) 9-5 V6t 01/98-08/05</p>	<p>02-34220-02</p> 	<p>08-34159-01</p> 			<p>61-34220-00 2x 47 73 453 87 Ø</p> 	<p>14-32104-02 45 01 060 (16x)</p> 	<p>15-34261-01 2x 47 70 764 +45 04 247</p> 	<p>12-31306-08 2x 45 00 898 (12x) 70-31306-00 45 00 898 24x</p> 	<p>71-34241-00 L 2x 47 70 418 71-34242-00 L 3x 47 70 426 71-34239-00 2x 45 03 652</p> 	<p>71-34159-00 45 02 167</p> 	<p>81-28236-00 K 90 322 669 30x50 A SL RD FPM 81-38229-00 K 45 01 201 90x104 A SL LD 81-24909-10 N 45 03 983 35x48 A SL RD MVQ</p> 

SAAB

<p>Ltr. </p>	<p>3,0 B308I</p>	<p>155 kW (211 PS)</p>	<p>9000 V6</p>	<p> 07/94-12/98</p>											
<p>3,0 D308L</p>	<p>130 kW (177 PS)</p>	<p>9-5 T1D</p>	<p>07/01-08/05</p>		<p>02-34220-01 47 73 453 87 Ø</p> 	<p>08-34159-01</p> 		<p>61-34220-00 2x 47 73 453 87 Ø</p> 	<p>14-32104-02 45 01 060 (16x)</p> 	<p>15-34268-02 2x 93 21 969</p> 	<p>12-31306-08 2x 45 00 898 (12x)</p>  <p>70-31306-00 45 00 898</p> 	<p>71-34241-00  2x 47 70 418</p>  <p>71-34242-00   3x 47 70 426</p>  <p>71-34239-00  2x 45 03 652</p> 		<p>81-28236-00  K↔ 90 322 669 38x50 A SL RD FPM</p>  <p>81-38229-00  K↔ 45 01 201 90x104 A SL LD</p>  <p>81-24909-10 N 45 03 983 35x48 A SL RD MVQ</p> 	
					<p>02-36216-01 2x</p> 			<p>61-36185-00 R 59 50 696 1  MLS</p> <p>61-36185-10 R 59 50 704 2  MLS</p> <p>61-36185-20 R 59 50 712 3  MLS</p>  <p>61-36190-00 L 59 50 662 1  MLS</p> <p>61-36190-10 L 59 50 670 2  MLS</p> <p>61-36190-20 L 59 50 668 3  MLS</p> 	<p>14-32288-01</p> 	<p>71-36216-00 2x 59 54 722</p> 	<p>12-36206-01 2x 59 50 597 (12x)</p>  <p>70-36206-00 59 50 597 (24x)</p> 	<p>71-36309-00   2x 59 52 486</p>  <p>71-36314-00  2x 59 52 684</p> 		<p>81-36231-00  K↔ 50x68 A SL RD FPM</p>  <p>81-53077-00  K↔ 59 50 415 95x118 A SL LD FPM</p>  <p>81-36971-00 N 37x50 A SL LD ACM</p> 	

SAAB

Ltr.  3,0 LF1 198 kW (269 PS)  Tractor  1 02/11-12/11

				<p>61-37220-00 R MLS</p>  <p>61-37225-00 L MLS</p> 	<p>14-32293-01 2x</p> 	<p>71-40676-00 L</p>  <p>71-40708-00 R</p> 	<p>12-38226-01 2x</p>      <p>70-38226-00 24x</p> 	<p>71-40688-00 2x</p> 	<p>70-31414-10</p> 	<p>81-38237-00 K</p> <p>50x70 AB SL RD PTFE</p> 
--	--	---	--	---	---	---	--	---	--	---

Haftungsausschluss

(für Katalog)

Alle Angaben in unserem Katalog wurden von uns sorgfältig geprüft, sind jedoch unverbindlich. Ersatzansprüche wegen Katalogangaben werden von uns nicht anerkannt. Der Käufer ist selbst verpflichtet, zu prüfen, ob unsere Teile für seine Zwecke geeignet sind. In allen Zweifelsfällen sollte Rücksprache mit unserem technischen Kundendienst erfolgen **Tel. +49 731 7046 999**.

Technische Weiterentwicklungen oder Änderungen bleiben vorbehalten, soweit damit keine Nachteile für den Kunden verbunden sind.

Angaben, Namens- und Markenzeichen, Beschreibungen, Nummern von Fahrzeugnummern und Herstellerzeichen, Original-Ersatzteilnummern der Fahrzeug- und Motorenhersteller u. a. sind ausschließlich für interne Zwecke gedacht. Solche Kennzeichnungen dürfen Fahrzeugbesitzern gegenüber nicht verwendet werden.

Wir weisen ausdrücklich darauf hin, dass alle von uns gelieferten Teile von geschultem Fachpersonal einzubauen sind. Reinz haftet für Fehler in diesem Katalog nur, wenn diese für den Kunden nicht offenbar erkennbar sind sowie nur bei Vorsatz und grober Fahrlässigkeit von Reinz, eines Vertreters oder eines Erfüllungsgehilfen. Dieser Haftungsausschluss gilt nicht im Rahmen

des Anwendungsbereichs des Produkthaftungsgesetzes und nicht bei Verletzung von Körper, Leben und Gesundheit, sowie bei der Verletzung von sog. Kardinalpflichten. Darüber hinaus ist unsere Haftung für Schäden, insbesondere für Personen-, Sach- oder Vermögensschäden, die unmittelbar oder mittelbar im Zusammenhang mit der Nutzung dieses Kataloges auftreten, sowie für nicht voraussehbare Schäden ausgeschlossen.

Reinz ist Inhaber aller Schutzrechte an den in diesem Katalog gespeicherten Daten. Kopie, Nachdruck, ganze oder teilweise Übernahme der Inhalte und Vervielfältigung, auch auszugsweise, ist nur mit unserer vorheriger schriftlicher Zustimmung sowie mit unserem Urheberrechtsvermerk zulässig.

Für Bestellungen, welche ab dem Erscheinungsdatum eines neuen Katalogs getätigt werden, sind alleine die Angaben des neuen Katalogs maßgeblich. Auf Angaben im Vorkatalog kann bei Neubestellungen nicht mehr zurückgegriffen werden.

Sofern Sie noch Fragen haben, bitten wir Sie, sich mit uns in Verbindung zu setzen.

VictorReinz.com/AGB

Exclusion of Liability

(for catalog)

All details in our catalog have been thoroughly checked by us but are however not binding. Right to damages on account of catalog details will not be recognized. The purchaser is obliged to check if our parts are suitable for their use. In all doubtful cases, the purchaser should consult our technical customer service under **+49 731 7046 999**.

We reserve the right to further technical developments or changes as long as no disadvantage for the customer results.

Details, name and trademarks, descriptions, numbers from vehicle numbers and manufacturer symbols, original vehicle replacement part numbers and engine manufacturer etc. are solely for internal use. Such labels must not be used with vehicle owners.

We specifically point out that all parts supplied by us must be assembled by trained specialists.

Reinz is liable for mistakes in this catalog only when they are not clearly recognizable for the customer, as well as by intent or gross negligence on the part of Reinz, its representative or vicarious agent. This exclusion of liability does not apply within the framework of the field of

application of the product liability laws and not by bodily harm, life and health, as well as by violation of cardinal duties. In addition, our liability for damages, especially personal, property or financial damages that occur directly or indirectly as a result of the use of this catalog, as well as non-foreseeable damages are excluded.

Reinz is the owner of all patent rights on the data stored in this catalog. Copies, reprints, whole or partial takeover of the contents and duplication even in excerpts are only permissible with our prior written approval, as well as with our copyright note.

For orders placed after the publication date of a new catalog, only the details in the new catalog are binding and no fall back to details in the previous catalog is possible.

In case you have further questions, do not hesitate to contact us.

VictorReinz.com/AGB

VictorReinz.com

reinz.info@dana.com

Technical Hotline +49 (0)731 7046-9 99

REINZ-Dichtungs-GmbH

Reinzstrasse 3-7
89233 Neu-Ulm
Germany
+49 (0)731 7046-0

VICTOR REINZ[®]

