

VICTOR REINZ®

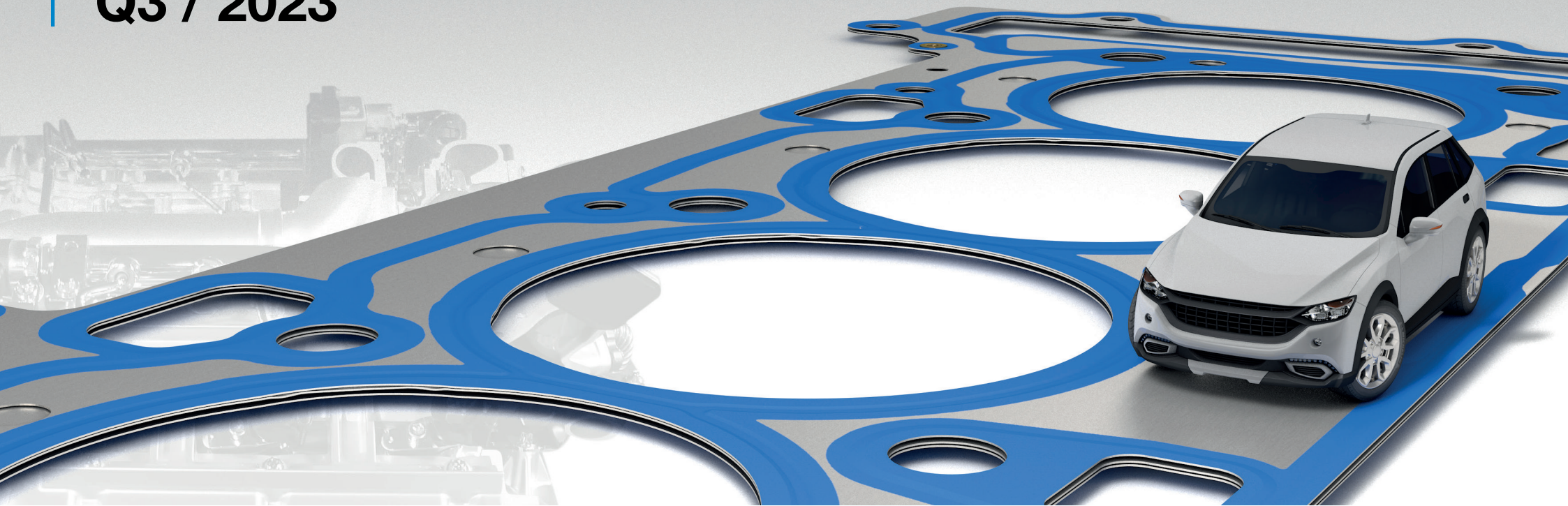

SMART-MCC
Q3 / 2023



VictorReinz.com/online-catalog

Victor Reinz®

at a Glance



Online Catalog

VictorReinz.com/online-catalog



Newsletter

VictorReinz.com/EN/News/Newsletter.aspx?region



Youtube

www.youtube.com/user/VictorReinzSealingEN



Catalog News

VictorReinz.com/news



Technical Service Information

VictorReinz.com/tsi



Facebook

www.facebook.com/VictorReinzParts



Just seal it!

VictorReinz.com/jsi



Technical Datasheet

VictorReinz.com/jsi-datasheet



LinkedIn

www.linkedin.com/showcase/victor-reinz-emea



Safety Datasheet

VictorReinz.com/jsi-datasheet



Homepage

VictorReinz.com

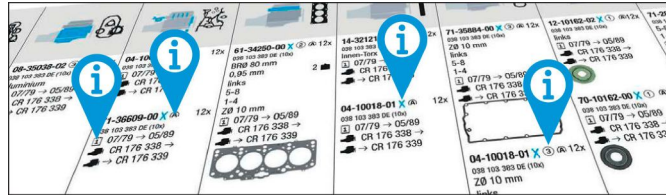

[VictorReinz.com/catalog-info](https://www.victorreinz.com/catalog-info)

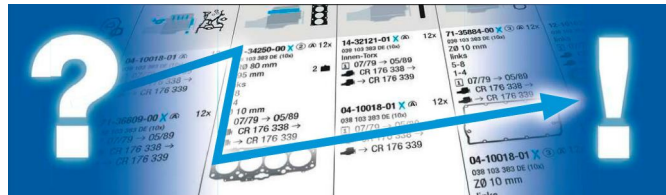

[VictorReinz.com/catalog-how-to-use](https://www.victorreinz.com/catalog-how-to-use)

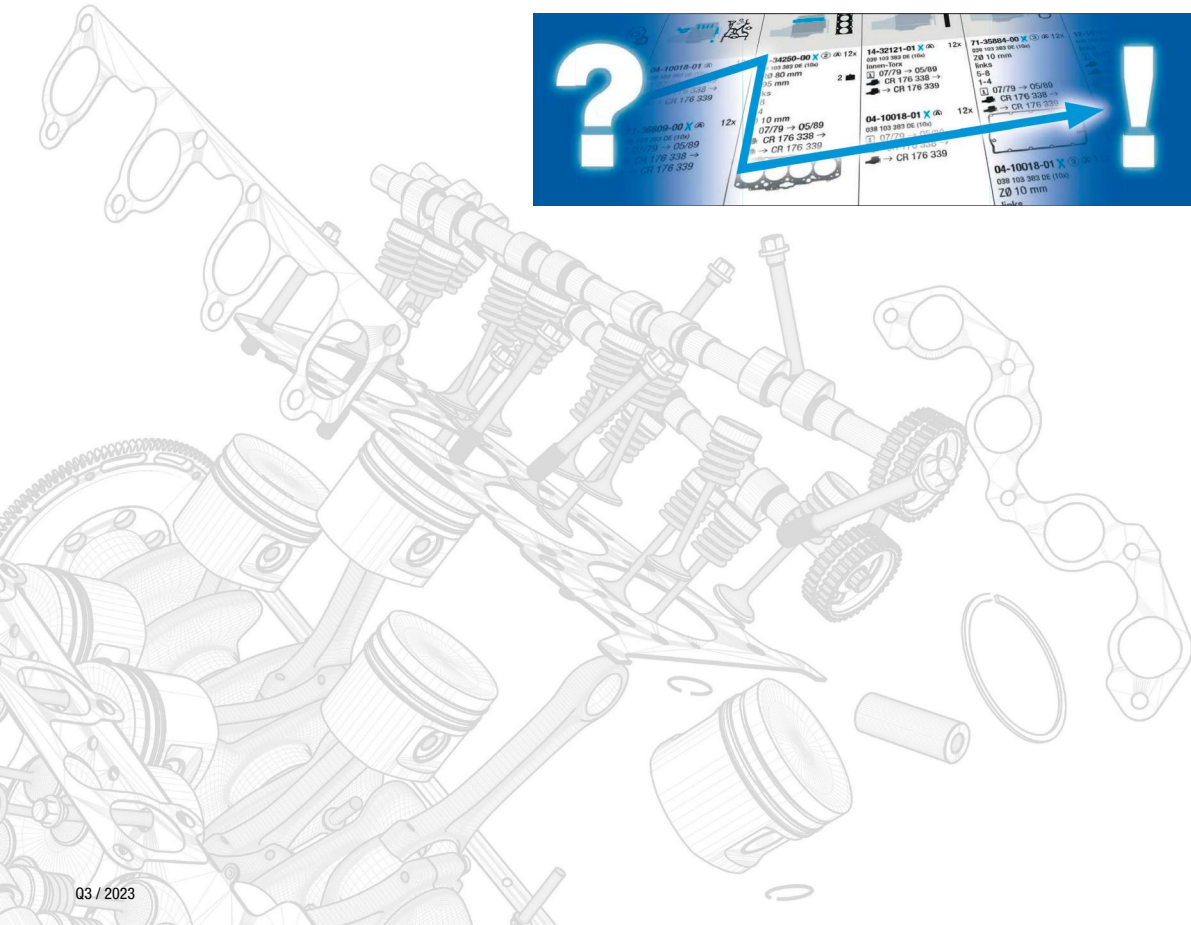

SMART-MCC

























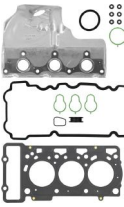



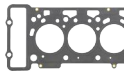

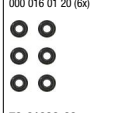

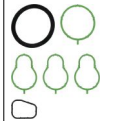





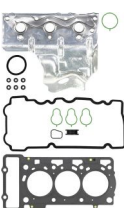

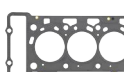
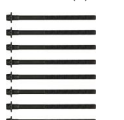
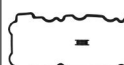
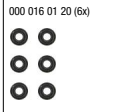

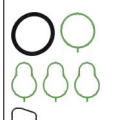









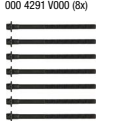
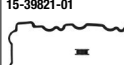
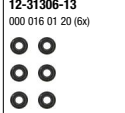

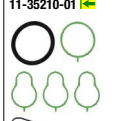





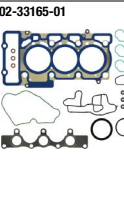

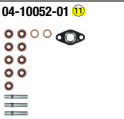

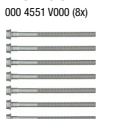
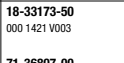
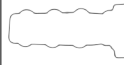
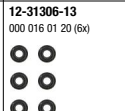
H
H4B 409 6

M
M 132.910 6
M 132.930 7
M 134.910 7
M 134.911 7
M 135.930 8
M 135.950 8
M 160 E6AL B03 5
M 160 E6AL B04 5
M 160 E6AL B05 5
M 160.910 5
M 160.920 5
M 160.921 5
M 160.922 5
M 160.923 5
M 281.910 6
M 281.920 7

O
OM 639.939 8
OM 660 DE 8LA 5
OM 660.940 6
OM 660.950 5
OM 660.951 6

SMART-MCC

<p>Ltr. </p>	<p>0,6 M 160 EGAL B03 M 160 EGAL B04 M 160 EGAL B05 M 160.910</p>	<p>33-55 kW (45-75 PS)</p>	<p> CABRIO CITY-COUPE CROSSBLADE FORTWO FORTWO BRABUS</p>	<p> 07/98-02/07</p>											
<p>0,6 M 160 EGAL B03 M 160 EGAL B04 M 160 EGAL B05 M 160.910</p>	<p>33-55 kW (45-75 PS)</p>	<p>CABRIO CITY-COUPE CROSSBLADE FORTWO FORTWO BRABUS</p>	<p>07/98-02/07</p>	<p>02-31400-01</p> 	<p>08-35226-01</p> 	<p>04-10009-01 </p> 	<p>61-31400-00 000 3086 V003 64 Ø 0,45 mm</p> 	<p>14-32043-01 000 4291 V000 (8x)</p> 	<p>15-39821-01</p> 	<p>12-31306-13 000 016 01 20 (6x)</p> 	<p>70-31306-00 000 016 01 20</p> 	<p>11-35210-01 </p> 	<p>70-31414-10</p> 	<p>81-35035-00 </p> <p>40x62 A RD PTFE ACM</p>  <p>81-35051-00 </p> <p>80x100 A LD PTFE ACM</p> 	
<p>0,7 M 160.920 M 160.921</p>	<p>37-60 kW (50-82 PS)</p>	<p>CABRIO CITY-COUPE FORTWO ROADSTER</p>	<p>01/03-01/07</p>	<p>02-33895-01</p> 	<p>08-35226-01</p> 	<p>61-33895-00 160 016 03 20 67 Ø MLS</p> 	<p>14-32043-01 000 4291 V000 (8x)</p> 	<p>15-39821-01</p> 	<p>12-31306-13 000 016 01 20 (6x)</p> 	<p>70-31306-00 000 016 01 20</p> 	<p>11-35210-01 </p> 	<p>70-31414-10</p> 	<p>81-35035-00 </p> <p>40x62 A RD PTFE ACM</p>  <p>81-35051-00 </p> <p>80x100 A LD PTFE ACM</p> 		
<p>0,7 M 160.922 M 160.923</p>	<p>45-74 kW (61-101 PS)</p>	<p>ROADSTER ROADSTER BRABUS</p>	<p>04/03-11/05</p>	<p>02-33895-01</p> 	<p>08-35226-01</p> 	<p>04-10009-01 </p> 	<p>61-33895-00 160 016 03 20 67 Ø MLS</p> 	<p>14-32043-01 000 4291 V000 (8x)</p> 	<p>15-39821-01</p> 	<p>12-31306-13 000 016 01 20 (6x)</p> 	<p>70-31306-00 000 016 01 20</p> 	<p>11-35210-01 </p> 	<p>70-31414-10</p> 	<p>81-35035-00 </p> <p>40x62 A RD PTFE ACM</p>  <p>81-35051-00 </p> <p>80x100 A LD PTFE ACM</p> 	
<p>0,8 OM 660 DE 8LA OM 660.950</p>	<p>30-33 kW (41-45 PS)</p>	<p>CABRIO CDI CITY-COUPE CDI FORTWO FORTWO CDI</p>	<p>11/99</p>	<p>02-33165-01</p> 	<p>08-35224-01</p> 	<p>04-10052-01 </p> 	<p>61-33165-00 660 016 01 20 66,5 Ø MLS</p> 	<p>14-32173-01 000 4551 V000 (8x)</p> 	<p>18-33173-50 000 1421 V003</p> 	<p>71-36807-00 660 016 00 00</p> 	<p>12-31306-13 000 016 01 20 (6x)</p> 	<p>70-31306-00 000 016 01 20</p> 	<p>71-36503-00 </p> <p>000 7189 V001</p> 	<p>70-31414-10</p> 	<p>81-35035-00 </p> <p>40x62 A RD PTFE ACM</p>  <p>81-35051-00 </p> <p>80x100 A LD PTFE ACM</p> 

SMART-MCC														
0,8	OM 660.940	30 kW (41 PS)												
Ltr.														
0,8	OM 660.940	30 kW (41 PS)		CABRIO CDI CITY-COUPE CDI FORTWO CDI	11/99-01/07									
				02-33165-01	08-35224-01	04-10052-01	61-33165-00 660 016 01 20 66,5 Ø MLS	14-32173-01 000 4551 V000 (6x)	18-33173-50 000 1421 V003	12-31306-13 000 016 01 20 (6x)	71-36503-00 000 7189 V001 71-33226-00 000 4613 V002	70-31414-10	81-35035-00 K↔ 40x62 A RD PTFE ACM	81-35051-00 K↔ 80x100 A LD PTFE ACM
0,8	OM 660.951	40 kW (54 PS)												
				FORTWO	08/09									
				01-10002-01			61-33165-00 660 016 01 20 66,5 Ø MLS		18-33173-50 000 1421 V003 71-36807-00 660 016 00 00	12-31306-13 000 016 01 20 (6x)	71-36503-00 000 7189 V001 71-33226-00 000 4613 V002	70-31414-10	81-10401-00 K↔ 40x62 A SL RD FPM	81-35051-00 K↔ 80x100 A LD PTFE ACM
0,9	H4B 409 M 281.910	61-80 kW (84-109 PS)												
				FORFOUR BRABUS FORTWO FORTWO BRABUS	09/14									
				02-10185-01 281 010 47 00	08-10042-01 281 010 48 00		61-10185-00 73,5 Ø 0,6 mm MLS	14-12221-01	71-12218-00 281 016 04 00	12-53036-02 282 017 02 60	71-12217-00 281 091 02 60 71-40013-00	70-31414-10	81-10478-00 K↔ 282 017 00 00 40x52 PTFE	81-10479-00 K↔ 282 017 02 00 84x117 PTFE
1,0	M 132.910	45-52 kW (61-71 PS)												
				FORTWO	01/07									
				01-37560-01			61-37560-00 132 016 01 20		71-39822-00 132 016 00 21	12-34223-01 135 053 00 58 (12x)	11-10401-01 132 013 00 80	70-31414-10	81-39029-00 K↔ 132 032 00 80 27x40 AB RD FPM	81-10404-00 K↔ 132 010 00 68 85 Ø FPM

SMART-MCC														
Ltr.														
1,0 M 132.930	62-75 kW (84-102 PS)	FORTWO FORTWO BRABUS	01/07	01-37555-01 				61-37555-00 132 016 00 20 		71-39822-00 132 016 00 21 	12-34223-01 135 053 00 58 (12x) 70-34223-00 135 053 00 58 	11-10401-01 132 013 00 80 71-39167-00 132 141 00 80 	70-31414-10 	81-39029-00 132 032 00 80 27x40 AB RD FPM 81-10404-00 132 010 00 68 85 Ø FPM
1,0 M 132.930	88 kW (120 PS)	FORTWO BRABUS	04/12	01-37555-01 				61-37555-00 132 016 00 20 	14-10969-01 	71-39822-00 132 016 00 21 	12-34223-01 135 053 00 58 (12x) 70-34223-00 135 053 00 58 	11-10401-01 132 013 00 80 71-39167-00 132 141 00 80 	70-31414-10 	81-39029-00 132 032 00 80 27x40 AB RD FPM 81-10404-00 132 010 00 68 85 Ø FPM
1,0 M 281.920	45-52 kW (60-71 PS)	FORFOUR FORTWO	07/14		02-10185-02 281 010 46 00 	08-10042-02 281 010 49 00 		61-10185-00 73,5 Ø 0,6 mm MLS 	14-12221-01 	71-12218-00 281 016 04 00 	12-38628-02 200 053 01 00 (12x) 70-53036-10 	71-12232-00 453 528 00 00 71-41372-00 281 142 05 80 	70-31414-10 	81-10478-00 282 017 00 00 40x52 PTFE 81-10479-00 282 017 02 00 84x117 PTFE
1,1 M 134.910 M 134.911	47-55 kW (64-75 PS)	FORFOUR	01/04	01-34245-01 				61-34245-00 134 016 01 20 76 Ø 	14-10276-02 	71-39021-00 134 016 00 21 	12-34223-01 135 053 00 58 (12x) 70-34223-00 135 053 00 58 	71-39022-00 135 141 00 80 71-34912-00 134 142 02 80 	70-31414-10 	81-39028-00 134 010 00 80 29x48 A RD 81-10657-00 135 010 00 68 85 Ø LD PTFE

SMART-MCC																
Ltr.																
1,3 M 135.930	70 kW (95 PS)	FORFOUR	01/04-06/06	01-34240-01 					61-34240-00 135 016 01 20 76 Ø 			71-39019-00 135 016 00 21 	12-34223-02 135 053 00 58 (16x) 16x 70-34223-00 135 053 00 58 	71-39022-00 135 141 00 80 4x 71-34911-00 135 142 02 80 	70-31414-10 	81-39028-00 134 010 00 80 29x48 A RD 81-10657-00 135 010 00 68 85 Ø LD PTFE
1,5 M 135.950	80-90 kW (109-122 PS)	FORFOUR	01/04-06/06	01-34240-01 					61-34240-00 135 016 01 20 76 Ø 			71-39019-00 135 016 00 21 	12-34223-02 135 053 00 58 (16x) 16x 70-34223-00 135 053 00 58 	71-39022-00 135 141 00 80 4x 71-34911-00 135 142 02 80 	70-31414-10 	81-39028-00 134 010 00 80 29x48 A RD 81-10657-00 135 010 00 68 85 Ø LD PTFE
1,5 OM 639.939	50-70 kW (68-95 PS)	FORFOUR CDI	09/04-06/06		02-10009-01 	08-10016-01 	04-10227-01 	61-37545-00 639 016 15 20 	14-32212-03 000 016 00 69 (8x) 	15-39017-01 639 016 05 21 +639 016 03 21 	12-31306-08 12x 70-31306-00 000 016 01 20 	71-39018-00 639 098 01 80 71-39027-00 639 142 03 80 	71-39031-00 639 014 04 22 	81-10401-00 40x62 A SL RD FPM 81-10435-00 640 010 15 68 90 Ø LD PTFE 		

Haftungsausschluss

(für Katalog)

Alle Angaben in unserem Katalog wurden von uns sorgfältig geprüft, sind jedoch unverbindlich. Ersatzansprüche wegen Katalogangaben werden von uns nicht anerkannt. Der Käufer ist selbst verpflichtet, zu prüfen, ob unsere Teile für seine Zwecke geeignet sind. In allen Zweifelsfällen sollte Rücksprache mit unserem technischen Kundendienst erfolgen **Tel. +49 731 7046 999**.

Technische Weiterentwicklungen oder Änderungen bleiben vorbehalten, soweit damit keine Nachteile für den Kunden verbunden sind.

Angaben, Namens- und Markenzeichen, Beschreibungen, Nummern von Fahrzeugnummern und Herstellerzeichen, Original-Ersatzteilnummern der Fahrzeug- und Motorenhersteller u. a. sind ausschließlich für interne Zwecke gedacht. Solche Kennzeichnungen dürfen Fahrzeugbesitzern gegenüber nicht verwendet werden.

Wir weisen ausdrücklich darauf hin, dass alle von uns gelieferten Teile von geschultem Fachpersonal einzubauen sind. Reinz haftet für Fehler in diesem Katalog nur, wenn diese für den Kunden nicht offenbar erkennbar sind sowie nur bei Vorsatz und grober Fahrlässigkeit von Reinz, eines Vertreters oder eines Erfüllungsgehilfen. Dieser Haftungsausschluss gilt nicht im Rahmen

des Anwendungsbereichs des Produkthaftungsgesetzes und nicht bei Verletzung von Körper, Leben und Gesundheit, sowie bei der Verletzung von sog. Kardinalpflichten. Darüber hinaus ist unsere Haftung für Schäden, insbesondere für Personen-, Sach- oder Vermögensschäden, die unmittelbar oder mittelbar im Zusammenhang mit der Nutzung dieses Kataloges auftreten, sowie für nicht voraussehbare Schäden ausgeschlossen.

Reinz ist Inhaber aller Schutzrechte an den in diesem Katalog gespeicherten Daten. Kopie, Nachdruck, ganze oder teilweise Übernahme der Inhalte und Vervielfältigung, auch auszugsweise, ist nur mit unserer vorheriger schriftlicher Zustimmung sowie mit unserem Urheberrechtsvermerk zulässig.

Für Bestellungen, welche ab dem Erscheinungsdatum eines neuen Katalogs getätigt werden, sind alleine die Angaben des neuen Katalogs maßgeblich. Auf Angaben im Vorkatalog kann bei Neubestellungen nicht mehr zurückgegriffen werden.

Sofern Sie noch Fragen haben, bitten wir Sie, sich mit uns in Verbindung zu setzen.

VictorReinz.com/AGB

Exclusion of Liability

(for catalog)

All details in our catalog have been thoroughly checked by us but are however not binding. Right to damages on account of catalog details will not be recognized. The purchaser is obliged to check if our parts are suitable for their use. In all doubtful cases, the purchaser should consult our technical customer service under **+49 731 7046 999**.

We reserve the right to further technical developments or changes as long as no disadvantage for the customer results.

Details, name and trademarks, descriptions, numbers from vehicle numbers and manufacturer symbols, original vehicle replacement part numbers and engine manufacturer etc. are solely for internal use. Such labels must not be used with vehicle owners.

We specifically point out that all parts supplied by us must be assembled by trained specialists.

Reinz is liable for mistakes in this catalog only when they are not clearly recognizable for the customer, as well as by intent or gross negligence on the part of Reinz, its representative or vicarious agent. This exclusion of liability does not apply within the framework of the field of

application of the product liability laws and not by bodily harm, life and health, as well as by violation of cardinal duties. In addition, our liability for damages, especially personal, property or financial damages that occur directly or indirectly as a result of the use of this catalog, as well as non-foreseeable damages are excluded.

Reinz is the owner of all patent rights on the data stored in this catalog. Copies, reprints, whole or partial takeover of the contents and duplication even in excerpts are only permissible with our prior written approval, as well as with our copyright note.

For orders placed after the publication date of a new catalog, only the details in the new catalog are binding and no fall back to details in the previous catalog is possible.

In case you have further questions, do not hesitate to contact us.

VictorReinz.com/AGB

VictorReinz.com

reinz.info@dana.com

Technical Hotline +49 (0)731 7046-9 99

REINZ-Dichtungs-GmbH

Reinzstrasse 3-7
89233 Neu-Ulm
Germany
+49 (0)731 7046-0

VICTOR REINZ[®]

