

VICTOR REINZ®

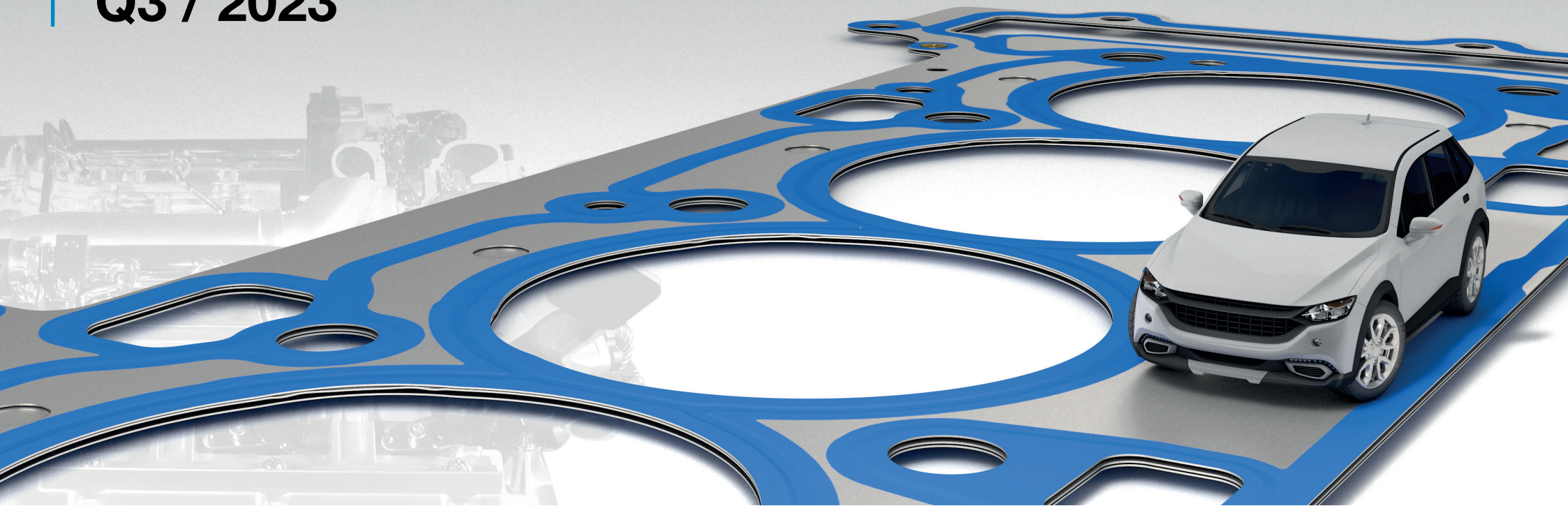

TALBOT
Q3 / 2023



VictorReinz.com/online-catalog

Victor Reinz®

at a Glance



Online Catalog

VictorReinz.com/online-catalog



Newsletter

VictorReinz.com/EN/News/Newsletter.aspx?region



Youtube

www.youtube.com/user/VictorReinzSealingEN



Catalog News

VictorReinz.com/news



Technical Service Information

VictorReinz.com/tsi



Facebook

www.facebook.com/VictorReinzParts



Just seal it!

VictorReinz.com/jsi



Technical Datasheet

VictorReinz.com/jsi-datasheet



LinkedIn

www.linkedin.com/showcase/victor-reinz-emea



Safety Datasheet

VictorReinz.com/jsi-datasheet



Homepage

VictorReinz.com

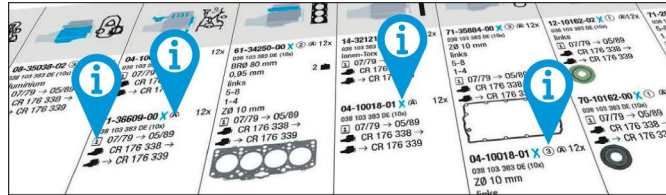

[VictorReinz.com/catalog-info](https://www.victorreinz.com/catalog-info)

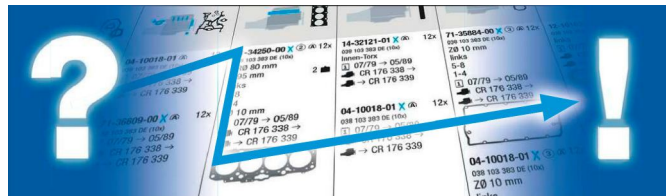

[VictorReinz.com/catalog-how-to-use](https://www.victorreinz.com/catalog-how-to-use)

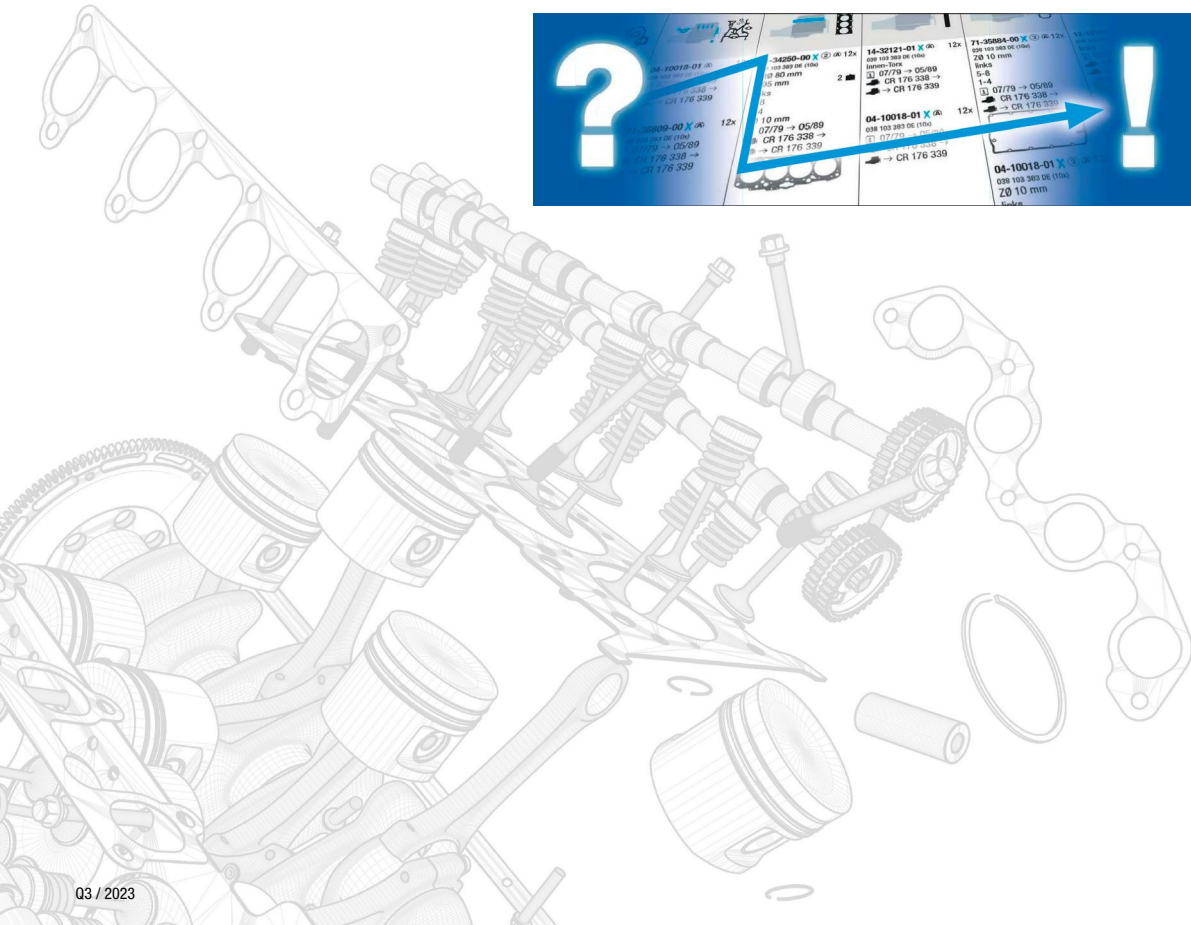

TALBOT



0-9

129 D	6
1G1	6
2G1	6
2G1-BTC	6
2Y1	7
2Y1B	7
2Y2	7
3E1	5
3E1A	5
3G4	6
5C1(XV5)	5
5C1(XV8)	5
6G1	7
6G1D	6
6G1D/VP	6
6J1	8
6J1B	8
6J2	8
6J2A	8
6Y1	7
6Y2	7
6Y2-BTC	7
6Y2D	7
9L6	11

C

CRD93	10
CRD93LS	10

E

E1B	5
-----	---

G

G1E/ECO	6
---------	---

J

J1	8
J1B	8
J2	8
J2A	8

X

X3Y2	7
X3Y2A	7















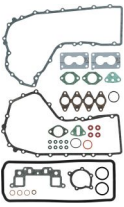



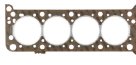















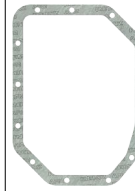







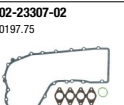
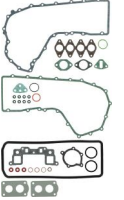



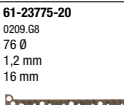

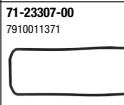
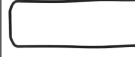
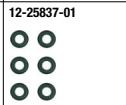

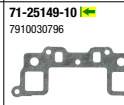





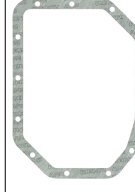
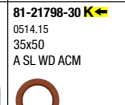









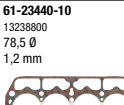
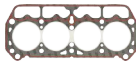

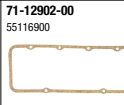

X5J2A	8
XD2S	10
XM7T	8
XN1TA	9
XN1TACP Kat.	9
XUD9	8
XUD9A	9
XV 5	5
XV 8	5
XW7	5
XY 6B	7
XY7	7
XY8	7
XZ7R	6

Y















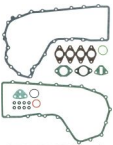

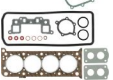



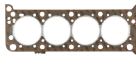





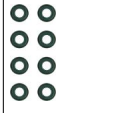



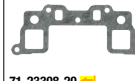



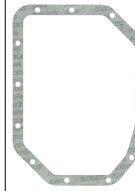





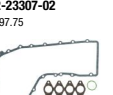

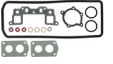



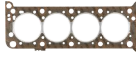

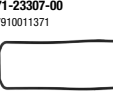
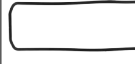

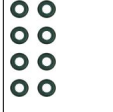







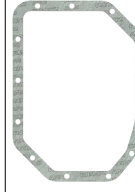
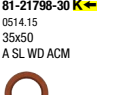







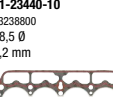

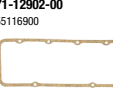

Y1B/ECO	7
Y2	7
Y2 BTC	7
Y2/BTC	7
Y2D/VP	7

TALBOT														
0,9	5C1(XV5) 5C1(XV8)	31 kW (42 PS)	SAMBA	01/81-12/85										
Ltr.					02-22970-02 9400198589	08-23542-01 		61-22970-10 7910023622 74 Ø 1,2 mm		71-23307-00 7910011371 	12-25837-01 	71-25149-10 7910030796 	71-23542-30 0304.17 	81-21798-30 0514.15 35x50 A SL WD ACM
											70-25837-00 	71-23308-20 7910008467 8x 		81-23578-00 0514.14 78x100 A LD MVQ
1,0	XV 5 XV 8	31-34 kW (42-46 PS)			02-22970-02 9400198589	08-23542-01 		61-22970-10 7910023622 74 Ø 1,2 mm		71-23307-00 7910011371 	12-25837-01 	71-25149-10 7910030796 	71-23542-30 0304.17 	81-21798-30 0514.15 35x50 A SL WD ACM
											70-25837-00 	71-23308-20 7910008467 8x 		81-23578-00 0514.14 78x100 A LD MVQ
1,1	E1B 3E1 3E1A	37-44 kW (50-60 PS)	HORIZON 1100	10/68-09/84						71-12902-00 55116900 	12-25837-01 	71-24161-00 13236800 		
											70-25837-00 	71-25149-10 7910030796 		
1,1	XW7	37 kW (50 PS)	SAMBA	01/81-06/86	02-23307-01 0197.74 	08-23542-01 		61-23775-20 0209.G8 76 Ø 1,2 mm 16 mm		71-23307-00 7910011371 	12-25837-01 	71-25149-10 7910030796 	71-23542-30 0304.17 	81-21798-30 0514.15 35x50 A SL WD ACM
					02-23775-06 0197.74 +0209.G8		61-27265-10 0209.A6 76 Ø 1,3 mm 14 mm				70-25837-00 	71-23308-20 7910008467 8x 		81-23578-00 0514.14 78x100 A LD MVQ
					02-27265-02 0197.75 +0209.A6									

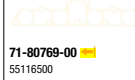
TALBOT

<p>Ltr.  1.2 XZ7R  65-66 kW (88-90 PS)  1</p>		 <p>02-23307-01 0197.74</p> 	 <p>08-23542-01</p> 		 <p>61-23775-20 0209.G8 76 Ø 1,2 mm 16 mm</p>  <p>61-27265-10 0209.A6 76 Ø 1,3 mm 14 mm</p> 		 <p>71-23307-00 7910011371</p> 	 <p>12-25837-01</p>  <p>70-25837-00</p> 	 <p>71-25149-10 </p> <p>7910030796</p>  <p>71-23308-20 </p> <p>7910008467</p>  <p>71-21274-20  </p> <p>7910014596</p> 	 <p>71-23542-30 0304.17</p> 	 <p>81-21798-30 </p> <p>0514.15 35x50 A SL WD ACM</p>  <p>81-23578-00 </p> <p>0514.14 78x100 A LD MVQ</p> 
<p>1.2 129 D  65 kW (88 PS) SAMBA  01/83-10/86</p>		 <p>02-23307-02 0197.75</p> 	 <p>08-23542-01</p> 		 <p>61-23775-20 0209.G8 76 Ø 1,2 mm 16 mm</p> 		 <p>71-23307-00 7910011371</p> 	 <p>12-25837-01</p>  <p>70-25837-00</p> 	 <p>71-25149-10 </p> <p>7910030796</p>  <p>71-23308-20 </p> <p>7910008467</p>  <p>8x</p>	 <p>71-23542-30 0304.17</p> 	 <p>81-21798-30 </p> <p>0514.15 35x50 A SL WD ACM</p>  <p>81-23578-00 </p> <p>0514.14 78x100 A LD MVQ</p> 
<p>1.3 G1E/ECO  40-62 kW (54-84 PS) HORIZON  10/72 1G1 MATRA BAGHEERA 2G1 SOLARA 2G1-BTC 1000 3G4 1100 6G1D 1307 6G1D/VP</p>					 <p>61-23440-10 13238800 78,5 Ø 1,2 mm</p> 		 <p>71-12902-00 55116900</p> 	 <p>70-20116-00 8x 13074280</p> 	 <p>71-24161-00 </p> <p>13236800</p>  <p>71-80769-00 </p> <p>55116500</p> 	 <p>71-21718-00 12853300</p> 	

TALBOT

<p>Ltr.  1,4 XY 6B</p> <p>44-53 kW (60-72 PS)</p> <p> 1</p>		 <p>02-23307-02 0197.75</p>   <p>02-23775-05 0197.19</p>   <p>02-27265-02 0197.75 +0209.A6</p>	 <p>08-23542-01</p> 		 <p>61-23775-20 0209.G8 76 Ø 1,2 mm 16 mm</p>  <p>61-27265-10 0209.A6 76 Ø 1,3 mm 14 mm</p> 		 <p>71-23307-00 7910011371</p> 	 <p>12-25837-01</p>  <p>70-25837-00</p> 	 <p>71-25149-10 </p> <p>7910030796</p>  <p>71-23308-20 </p> <p>7910008467</p> <p>8x</p> 	 <p>71-23542-30 0304.17</p> 	 <p>81-21798-30 </p> <p>0514.15 35x50 A SL WD ACM</p>  <p>81-23578-00 </p> <p>0514.14 78x100 A LD MVQ</p> 
<p>1,4 XY7 XY8</p> <p>53-58 kW (72-79 PS)</p> <p>SAMBA</p> <p>01/81-10/86</p>		 <p>02-23307-02 0197.75</p>   <p>02-27265-02 0197.75 +0209.A6</p>	 <p>08-23542-01</p> 		 <p>61-23775-20 0209.G8 76 Ø 1,2 mm 16 mm</p> 		 <p>71-23307-00 7910011371</p> 	 <p>12-25837-01</p>  <p>70-25837-00</p> 	 <p>71-25149-10 </p> <p>7910030796</p>  <p>71-23308-20 </p> <p>7910008467</p> <p>8x</p> 	 <p>71-23542-30 0304.17</p> 	 <p>81-21798-30 </p> <p>0514.15 35x50 A SL WD ACM</p>  <p>81-23578-00 </p> <p>0514.14 78x100 A LD MVQ</p> 
<p>1,4 X3Y2 X3Y2A Y1B/ECO Y2 Y2 BTC Y2/BTC Y2D/VP 2Y1 2Y1B 2Y2 6G1 6Y1 6Y2 6Y2-BTC 6Y2D</p> <p>47-63 kW (65-86 PS)</p> <p>HORIZON 1308 1510</p> <p>11/78</p>					 <p>61-23440-10 13238800 78,5 Ø 1,2 mm</p> 		 <p>71-12902-00 55116900</p> 	 <p>70-20116-00 13074280</p> 	 <p>71-24161-00 </p> <p>13236800</p>  <p>71-80769-00 </p> <p>55116500</p> 	 <p>71-21718-00 12853300</p> 	

TALBOT

Ltr.	Icon	Power (kW/PS)	Model	Year	Image 1	Image 2	Image 3	Image 4	Image 5	Image 6	Image 7	Image 8	Image 9	Image 10	Image 11	Image 12
1,6	J1 J1B J2 J2A XSJ2A 6J1 6J1B 6J2 6J2A	51-66 kW (69-90 PS)	HORIZON MURENA SOLARA 1510	10/78												
										71-12902-00 55116900	12-25837-01 8x	71-80769-00 55116900	71-21718-00 12853300			
1,8	XM7T	51 kW (69 PS)	EXPRESS 1000 -1500 EXPRESS 1000 -1800	07/81-10/90												
										71-19231-00	12-23062-01 8x	71-17538-10	71-12921-20			
1,9	XUD9	47-48 kW (64-65 PS)	HORIZON D	07/82-06/86		02-25942-03 9400197379	08-25918-02		61-29165-10 0209.K0 84 Ø 1,6 mm 2	14-32077-01 9301030680 (10x)	71-25942-00 9301024280	12-25837-01 8x	71-33156-00 0348.98	71-25918-30 0304.34	81-25926-10 0326.12 42x62 A RD FPM	81-34456-00 90x110 A SL LD FPM
						02-25942-04			61-29165-20 0209.K1 84 Ø 1,7 mm 3				71-33157-00 0348.99	71-25919-30 9301040280	81-21798-30 0514.15 35x50 A SL WD ACM	2x
									61-31065-00 0209.S5 84 Ø 1,4 mm 1							
									61-31065-10 0209.S6 84 Ø 1,45 mm 2							
									61-31065-20 0209.S7 84 Ø 1,5 mm 3							
									61-31065-30 0209.S8 84 Ø 1,55 mm 4							
									61-31065-40 0209.S9 84 Ø 1,6 mm 5							

TALBOT

Ltr.  1,9 XUD9A 51 kW (69 PS) EXPRESS 1000 -1500 EXPRESS 1000 -1800 07/87-10/90  1

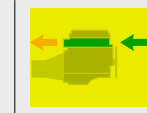

02-25942-05
 0209.K0
 84 Ø
 1,6 mm

08-25918-02

61-29165-10
 0209.K1
 84 Ø
 1,7 mm

61-31065-00
 0209.S5
 84 Ø
 1,4 mm

61-31065-10
 0209.S6
 84 Ø
 1,45 mm

61-31065-20
 0209.S7
 84 Ø
 1,5 mm

61-31065-30
 0209.S8
 84 Ø
 1,55 mm

61-31065-40
 0209.S9
 84 Ø
 1,6 mm

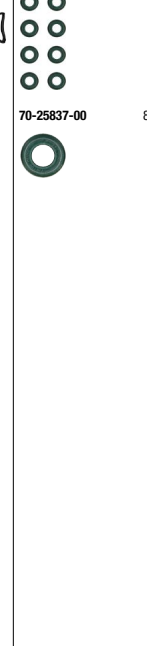
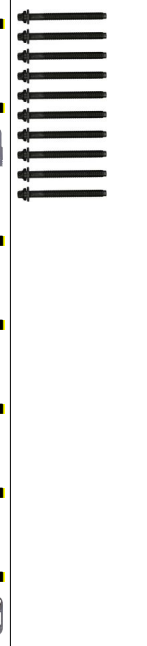
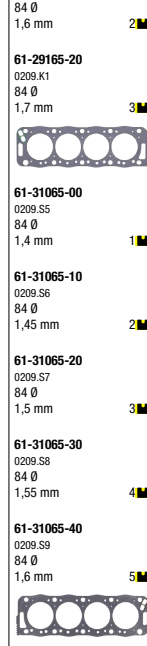
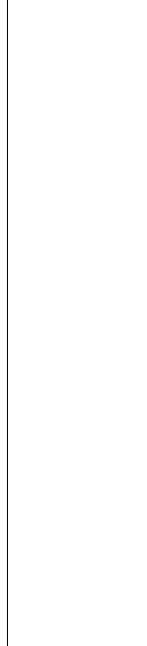







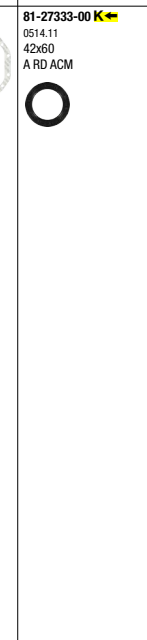
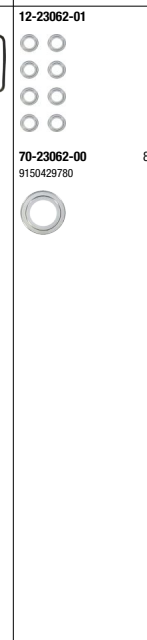
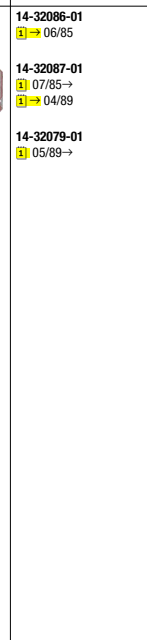
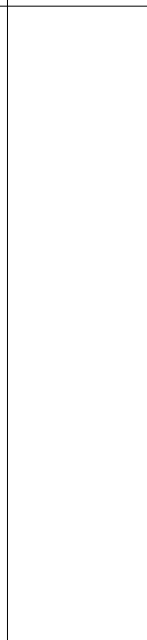
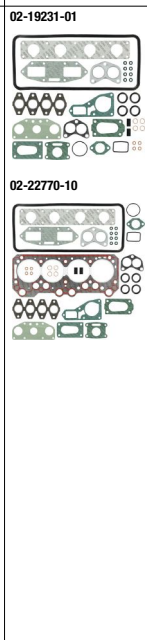





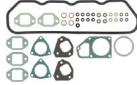



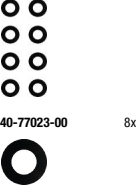















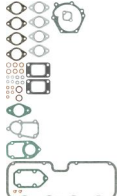
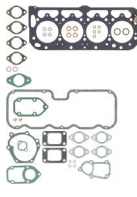

2,0 XN1TA XN1TACP Kat. 57-72 kW (78-98 PS) EXPRESS 1000 -1500 EXPRESS 1000 -1800 07/82

02-19231-01





02-22770-10





TALBOT

<p>Ltr.  2,3 XD2S 59 kW (80 PS) TAGORA TD  08/81-12/87</p>		<p>02-50919-11 0199.05</p> 			<p>61-26630-30 0209.55 96 Ø 1,5 mm 2</p> <p>61-26630-40 0209.50 96 Ø 1,6 mm 4</p> <p>61-26630-50 0209.51 96 Ø 1,7 mm 5</p> 	<p>14-32083-01 0204.55 (15x) +0204.56 (7x)</p>	<p>71-50919-10 7932564008</p> 	<p>12-77023-01</p> 	<p>71-25496-10  3x 7932581459</p> <p>71-25712-10  2x 7932588045</p> <p>40-77023-00 8x </p>	<p>71-25857-10 9350095980</p> 	<p>81-51051-20   0514.35 45x60 A SL RD FPM</p> 
<p>2,5 CRD93 54 kW (73 PS) EXPRESS 1000 -1500 EXPRESS 1000 -1800 07/82-10/94</p>		<p>02-24960-03</p>  <p>02-24960-04</p> 			<p>61-24960-10 95,5 Ø 1,5 mm</p> 	<p>14-32080-01</p> 	<p>71-25612-20</p> 		<p>71-25639-10  4x</p> 	<p>81-33859-00   75x90 A SL RD FPM/ACM</p> 	
<p>2,5 CRD93LS 70 kW (95 PS) EXPRESS 1000 -1500 EXPRESS 1000 -1800 06/87-10/94</p>		<p>02-24960-02</p>  <p>02-27015-01</p> 			<p>61-27015-10 95,5 Ø 1,7 mm</p> 	<p>14-32080-01</p> 	<p>71-25612-20</p> 	<p>12-23062-01</p> 	<p>50-92221-20  4x</p> <p>71-25639-10  4x</p> <p>70-23062-00 8x </p>	<p>81-33859-00   75x90 A SL RD FPM/ACM</p> 	

TALBOT

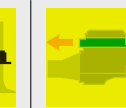
Ltr.  2,6 9L6 122 kW (166 PS)  TAGORA  1 08/81-10/83



61-23575-10 R
7910245291
90 Ø
1,2 mm



61-23576-10 L
7910045585
90 Ø
1,2 mm

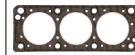

71-25260-10 L
7910246555



71-25261-10 R
7910245546



12-25837-01



70-25837-00



71-24564-00  6x
7910245244



71-24566-00  2x
7910245243



71-25254-10  6x
7910245345



81-21001-10  
0514.21
42x62
A SL RD ACM



81-18304-00  
0514.20
80x100
A LD MVQ



Haftungsausschluss

(für Katalog)

Alle Angaben in unserem Katalog wurden von uns sorgfältig geprüft, sind jedoch unverbindlich. Ersatzansprüche wegen Katalogangaben werden von uns nicht anerkannt. Der Käufer ist selbst verpflichtet, zu prüfen, ob unsere Teile für seine Zwecke geeignet sind. In allen Zweifelsfällen sollte Rücksprache mit unserem technischen Kundendienst erfolgen **Tel. +49 731 7046 999**.

Technische Weiterentwicklungen oder Änderungen bleiben vorbehalten, soweit damit keine Nachteile für den Kunden verbunden sind.

Angaben, Namens- und Markenzeichen, Beschreibungen, Nummern von Fahrzeugnummern und Herstellerzeichen, Original-Ersatzteilnummern der Fahrzeug- und Motorenhersteller u. a. sind ausschließlich für interne Zwecke gedacht. Solche Kennzeichnungen dürfen Fahrzeugbesitzern gegenüber nicht verwendet werden.

Wir weisen ausdrücklich darauf hin, dass alle von uns gelieferten Teile von geschultem Fachpersonal einzubauen sind. Reinz haftet für Fehler in diesem Katalog nur, wenn diese für den Kunden nicht offenbar erkennbar sind sowie nur bei Vorsatz und grober Fahrlässigkeit von Reinz, eines Vertreters oder eines Erfüllungsgehilfen. Dieser Haftungsausschluss gilt nicht im Rahmen

des Anwendungsbereichs des Produkthaftungsgesetzes und nicht bei Verletzung von Körper, Leben und Gesundheit, sowie bei der Verletzung von sog. Kardinalpflichten. Darüber hinaus ist unsere Haftung für Schäden, insbesondere für Personen-, Sach- oder Vermögensschäden, die unmittelbar oder mittelbar im Zusammenhang mit der Nutzung dieses Kataloges auftreten, sowie für nicht voraussehbare Schäden ausgeschlossen.

Reinz ist Inhaber aller Schutzrechte an den in diesem Katalog gespeicherten Daten. Kopie, Nachdruck, ganze oder teilweise Übernahme der Inhalte und Vervielfältigung, auch auszugsweise, ist nur mit unserer vorheriger schriftlicher Zustimmung sowie mit unserem Urheberrechtsvermerk zulässig.

Für Bestellungen, welche ab dem Erscheinungsdatum eines neuen Katalogs getätigt werden, sind alleine die Angaben des neuen Katalogs maßgeblich. Auf Angaben im Vorkatalog kann bei Neubestellungen nicht mehr zurückgegriffen werden.

Sofern Sie noch Fragen haben, bitten wir Sie, sich mit uns in Verbindung zu setzen.

VictorReinz.com/AGB

Exclusion of Liability

(for catalog)

All details in our catalog have been thoroughly checked by us but are however not binding. Right to damages on account of catalog details will not be recognized. The purchaser is obliged to check if our parts are suitable for their use. In all doubtful cases, the purchaser should consult our technical customer service under **+49 731 7046 999**.

We reserve the right to further technical developments or changes as long as no disadvantage for the customer results.

Details, name and trademarks, descriptions, numbers from vehicle numbers and manufacturer symbols, original vehicle replacement part numbers and engine manufacturer etc. are solely for internal use. Such labels must not be used with vehicle owners.

We specifically point out that all parts supplied by us must be assembled by trained specialists.

Reinz is liable for mistakes in this catalog only when they are not clearly recognizable for the customer, as well as by intent or gross negligence on the part of Reinz, its representative or vicarious agent. This exclusion of liability does not apply within the framework of the field of

application of the product liability laws and not by bodily harm, life and health, as well as by violation of cardinal duties. In addition, our liability for damages, especially personal, property or financial damages that occur directly or indirectly as a result of the use of this catalog, as well as non-foreseeable damages are excluded.

Reinz is the owner of all patent rights on the data stored in this catalog. Copies, reprints, whole or partial takeover of the contents and duplication even in excerpts are only permissible with our prior written approval, as well as with our copyright note.

For orders placed after the publication date of a new catalog, only the details in the new catalog are binding and no fall back to details in the previous catalog is possible.

In case you have further questions, do not hesitate to contact us.

VictorReinz.com/AGB

VictorReinz.com

reinz.info@dana.com

Technical Hotline +49 (0)731 7046-9 99

REINZ-Dichtungs-GmbH

Reinzstrasse 3-7
89233 Neu-Ulm
Germany
+49 (0)731 7046-0

VICTOR REINZ[®]

